

PRODUCT CATALOGUE



www.bvnair.com

INDEX

GENERAL INFORMATION	2
DUCT FANS	26
Circular Duct Fans	30
Rectangular and Square Duct Fans	46
Kitchen Exhaust Fans	64
Cabinet Fans	72
HEAT RECOVERY DEVICES	104
Ceiling Type Heat Recovery Devices	108
Heaters	110
SHELTER FANS	112
Shelter Fans	116
Filter Duct Devices	120
ROOF FANS	122
Horizontal Outlet Roof Fans	126
Vertical Outlet Roof Fans	161
EXPROOF FANS	168
Duct Type Exproof Fans	172
Roof Exproof Fans	174
Axial Exproof Fans	178
EC FANS	182
Duct Type EC Fans	186
Roof Type EC Fans	192
THERMO FANS	194
Jet Fans	198
Smoke Exhaust Ventilation Systems	200
Kitchen Exhaust Fans	264
AXIAL FANS	272
Cooling Fans	276
Pressuration Fans	285
Industrial Axial Fans	357
Ventilators & Aspirators	367
RADIAL FANS	370
Industrial Radial Fans	374
Single Inlet Radial Fans	392
Double Inlet Radial Fans	406
Components	418
BATHROOM FANS	426
Axial Bathroom Fans	430
Radial Bathroom Fans	438
ACCESSORIES	440
Speed Control Devices and Frequency Inverters	444
Shutters	445
Filters	447
Protection Wire Meshes	451
Vibration Springs	451
Heaters	452
Counter Flanges	452

BVN GLOBAL

We invite you to the world of Ventilation and Air Conditioning;
We offer the most efficient fan and Control systems to make your living spaces more reliable and comfortable.



From 1992 until today, BVN has been manufacturing electric motors and fans for various applications. Istanbul based production area of 30.000 m2, 400 experienced employees and has structuring in 72 countries with Global Brand Of Turkey! www.bvnair.com



We are registering our High Quality With Our Promises And Also Documents!

BVN certificated its quality with ISO 9001, ISO 14001, ISO 18001. BVN Products Follows International Standards Such as ISO and AMCA, also develops the most modern laboratory equipments and improve with the advanced technology softwares.



*TSE, CE Mark, UKR SEPRO, PCT GOST, ROHS Requirements are the standarts of BVN Products.

Our Smoke Exhaust Fans has the Fire Endurance certificates F300/H2 and F400/H2 taken from International Test Labrotories.

Before Packacing For the Each Product We deliver, We test our products performance and safety for you to use with peace.

Our Exproof Fans has the Atex Certificate.





TECHNICAL INFORMATIONS

The structure of external rotor motors ; are similar to normal non-asynchronous motors, the only difference between two is the place of motor and stator. Unlike Standard Motors, stator and winding placed at the center of the motor, the rotor serves as the outer casing. The motor shaft (connected to the rotor) is mounted on the ball bearings in the stator. Fan mounted on rotor. With this Design engine and fan have a holistic structure in air flow, through this holistic structure, transported air refrigerates the motor.

Motors and Wheels

* According to DIN ISO 1940, the fans are dynamically balanced on a double plane.

50/60 Hz

50/60 Hz data are stated in the technical tables.

Nominal Voltage / Frequency

Maximum allowed voltage difference according to DIN IEC 38 standards are +6%, -10%

Power Value

It is the maximum power that the fan takes from the electric network.

Nominal Current

The rated current is the maximum current that the fan draws from the mains at the specified voltage and frequency values. When the fan is controlled at low voltages, the motor current may exceed the rated current rating.

Power, Fan ve Efficiency Relationship

Motor Efficiency : $\eta_{motor} = P_2 / P_1 \times 100\%$
 Wheel Efficiency : $\eta_{impeller} = P_{air} / P_2 \times 100\%$
 Fan Efficiency : $\eta_{fan} = \eta_{motor} \times \eta_{impeller}$
 $\eta_{fan} = P_{air} / P_1 \times 100\%$

P_1 = Electrical input power

$P_{trifaze} = U \times I \times \cos\Phi \times \sqrt{3}$

$P_{1monofaze} = U \times I \times \cos\Phi$

U: Voltage I: Current $\cos\Phi$: Power Factor

P_2 = Mechanical power at the shaft

P_{air} = Hydraulic Power

$P_{air} = P_{Static Pressure} * Q_{Air Flow}$

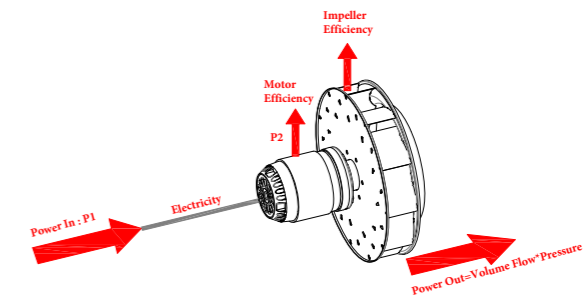

Maximum Temperature of Transported Air

Motors have specific operating temperatures. If the air transferred temperature is higher than the allowed temperature causes the motor to warm up. Therefore; The maximum permissible air temperature and rated current values are given in the product technical data table.

Air Flow

Air Flow measurements are made by following ISO 5801 ve AMCA 210 Standards. The tested fan was tested in the test room with open input and open output structure (type A) without any additional parts (protection grid, damper etc.) in nominal voltage and nominal current values. The default air density value is 1.2 kg /m³ at 20 °C. The maximum air flow rate given in the technical data table is given for the free throw condition (zero pressure).

Pressure

The static pressure value is shown in the fan diagram as Ps.

Revolutions Per Minute (r.p.m)

Nominal speed; nominal current value is given in the product technical tables.

Capacitor

Capacitors are connected to single-phase motors. The relevant capacity values are given in the product technical tables.

Sound Pressure and Sound Power Level

In the technical tables, sound pressure values are given according to distance. By the help of the technical table following, Power levels can be found.

	Room	Free Field	Sound Level Measurement
Room Volume	84 m ³	Free Field	$L_{pA} = L_{WA} + 10 \cdot \log \left[\frac{Q}{4\pi r^2} + \frac{4}{A_{eqv}} \right]$ L _{pA} – Sound Pressure Level, dB L _{WA} – Sound Power level, dB Q – Position factor r – Distance audio source (m) A _{eqv} – Equivalent damping area (m ²)
Equivalent Sound Emission Area of the Room	21 m ²	-	
Measuring Distance (r)	3 m	1-2-3-4-5-10 m	
Position Factor (Q)	1	1	
Difference between Sound Power (L _w) sound pressure (L _p)	-7 dB	-11/-17/-21/-23/-25/-31 dB	

* Measurements and indications are made by providing several measuring points from the rectangular measuring surface in accordance with the method of circumferential measuring surface described in accordance with ISO 13347-3.

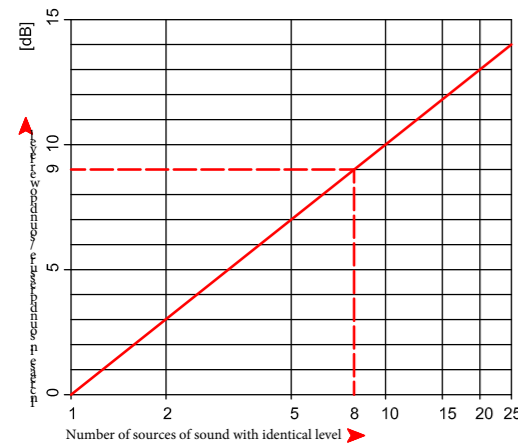

Total of noise sources with equal volume

The sound characteristics of multiple fans with equal volume can be easily calculated using the graphics on the left.

Example:

8 pieces SF-4M 400 Axial Fan is located on a Cooling Unit. The sound pressure of the SF-4M 400 fan is approximately 58 dB (A). According to the graph on the left, when the 8 products are operated together, an increase of 9 dB will occur and the overall sound pressure is estimated to be approximately 67 dB (A).

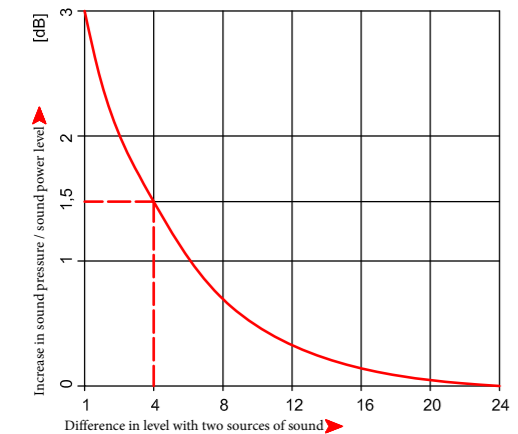

Collection of different noise sources

The acoustic values of fans with different sound levels can be determined in advance. The graphic on the left can be used for this.

Example:

There are 1 SF-4M 400 Axial Fans with sound pressure 58 dB (A) and 1 SF-4M 450 products with sound pressure 62 dB (A) in the Ventilation Unit. Difference between sound levels 4 dB the volume increase is read from the table approximately 1.5 dB. As a result, the sound pressure of the high value fan should be collected with 1.5 dB and the average sound pressure value can be expected to be 63.5 dB (A).

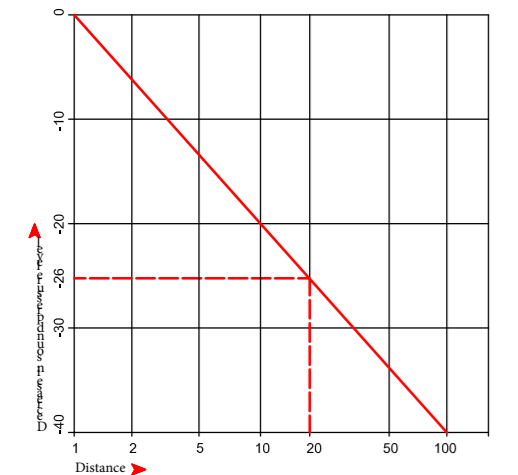

The change of the sound pressure according to the distance

Sound Power does not show varieties according to distance, on the contrary sound pressure decreases when it become distant from the sound source. The graph on the left shows the decrease in sound levels according to distance.

Example:

SF-4M 560 Sound pressure at the working point of the axial fan is 79 dB (A). For the sound pressure at 20 meters, the approximate decrease in sound pressure is 26 dB. The sound pressure value at a distance of 20 meters is expected to be 53 dB (A).

INSTALLATION INFORMATIONS

Fans shall be assembled according to the positions shown in the operation manual. All fans are designed for continuous working conditions. Products that work in dusty and oily environments must be used with appropriate filters and their maintenance must be done in the time specified in the user manual. In heat recovery devices, the heating equipment should be installed at the fan outlet at a minimum of two times the duct diameter.

Using the appropriate duct in the inlet and outlet connections of the fan prevents the loss of pressure and system efficiency due to turbulent flow. The inlet duct is of equal diameter with the suction diameter and the minimum of the fan diameter is two times; The outlet duct should be of equal diameter with the fan outlet diameter and should be at least three times the fan diameter. Elbow or reduction must not be used just before / after entry and exit. The ducts should be mounted with mounting brackets or flexible connections to protect against vibration.

Average duct diameter calculation for Rectangular Fans:

D = Duct Diameter
 H = Duct Height
 B = Duct Width

$$D = \sqrt{\frac{4 \cdot H \cdot B}{\pi}}$$

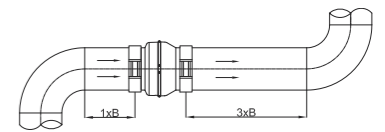

* fans are manufactured according to 3 precision classes Tolerance values are given in the table

Precision Category	0	1	2	3
Air Flow	3	±2,5 %	±5 %	±10 %
Pressure Increase	±1 %	±2,5 %	±5 %	±10 %
Motor Power	+2 %	+3 %	+8 %	+16 %
Efficiency	-1 %	-2 %	-5 %	-
Sound Pressure Level (A)	+3 dB	+3 dB	+4 dB	+6 dB

FAN TYPES

Centrifugal Fans

- Centrifugal fans are classified according to wing design. The most commonly used centrifugal fans for comfort and air conditioning are forward curved blades with backward curved blades and radial blades.
- The air is sucked by one or both side of the centrifugal fan impeller and is pressed at a right angle to the fan shaft Centrifugal fans are usually surrounded by a housing called a snail or fan housing.



Forward Curved

- The wings are Forward towards the direction of rotation.
- These type of Wings, Create a spoon effect in the air. Speed values are higher than other wing types, Therefore, the air flow rate is higher than the other wing shapes. This provides a smaller impeller diameter.
- These kind of fans flows are 2,5 times higher than backward curved fans with same size.
- Today This type of fans is used when the area is too small, the speed is low and the static pressure is low.
- Energy efficiency varies between 55-65%

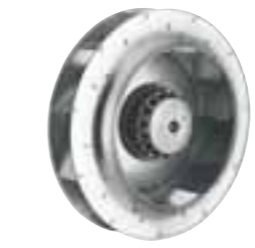

Backward Curved

- In this type of fan, the convex surfaces of the blades are directed towards the direction of rotation.
- This arrangement of the wings allows for a more regular flow of air between the wings by reducing impacts and bends, thus providing more efficient and lower sound values.
- In Fan-impeller blades with backward-curved blades must be taken into account. Because these fans have constant power consumption at the same operating speed, they can be used at high speed and pressure values.
- Wing yield varies between 60% and 80% according to the wing types. Wing profiles which designed by BVN engineers provides %70 efficiency.



Axial Fans

- Axial Fans, can reach high flow rates with low pressure.
- Tube axial fans can reach high pressure and flow rates
- Air flow moves along fan axis.
- Airfoil and Skew wing profiles designed by BVN engineers ensure quiet and highly efficient operation.



BVN EC Motors and Fans

EC (Electronic Controlled) engines show the final point of ventilation technology. EC fans advantages are summarized at the bottom.

- Higher efficiency across the performance curve
- Energy saving, low energy cost
- Up to 90% higher efficiency than traditional systems
- Easy control with the 0-10 V signal
- Long service life
- Low noise levels throughout the performance curve
- All control and protection equipment are integrated in the engine
- Easy electrical connection
- Less CO2 emissions
- Ventilation on request – easy air control for desired ventilation when required
- With the EC Motors moisture, temperature, pressure, CO2, time and motion sensitive sensors's automation can be provided

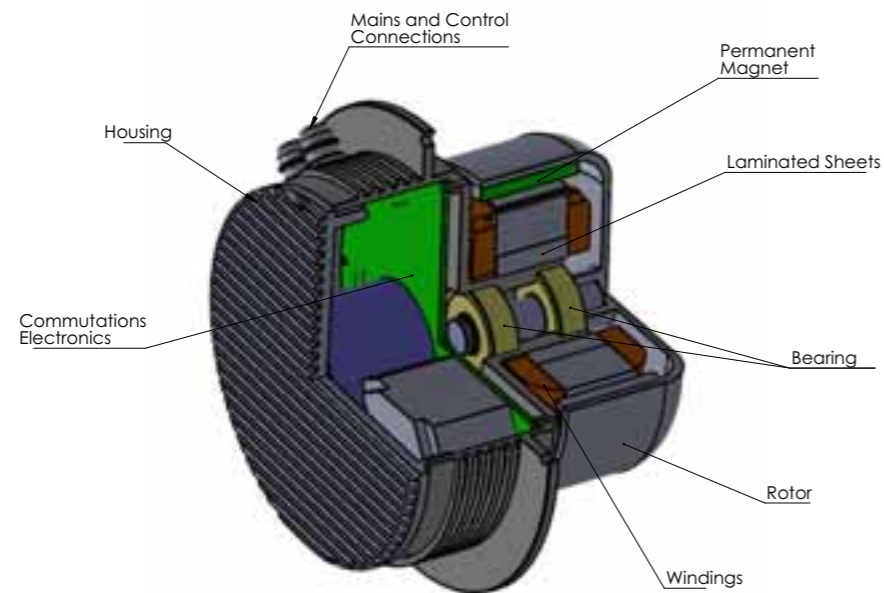

BVN AC Motors and Fans

Has a space saving feature thanks to the Compact Structure. Connection for the motor and fan without the need for any additional transmission element, the fan motor is connected directly to the rotor energy transfer is provided. Therefore they have efficient and low starting moments.

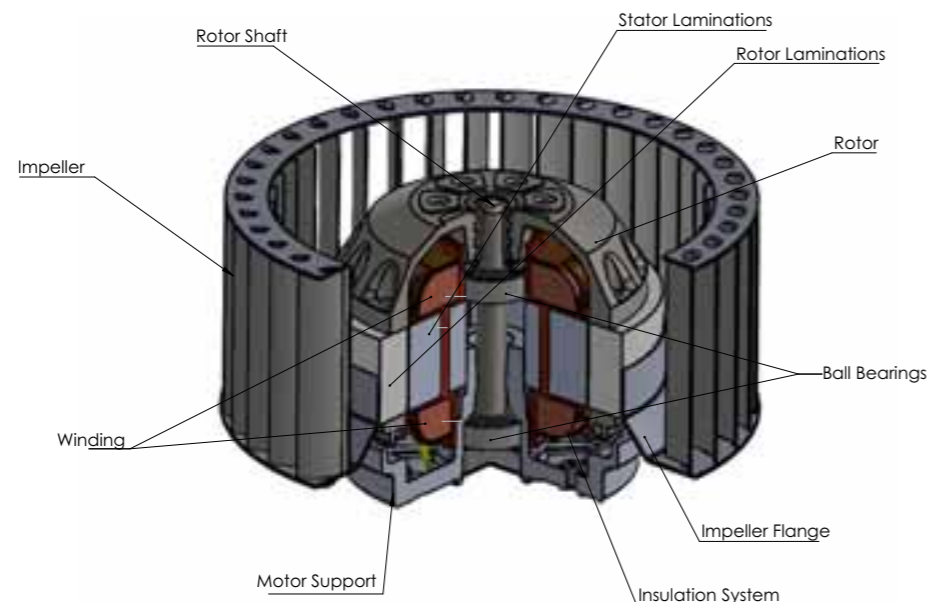

ErP DIRECTIVE

Energy saving products protects the nature and save costs at the same time. Erp Regulation is focused to reduce CO2 emission. It tries to achieve this goal by setting high efficiency targets for manufacturers.

Thanks to our comprehensive R & D activities, our highly efficient BVN products with blade profiles and engine performances follow up Erp targets.

Ecodesign directives (2009/125 / EC) includes 2020 strategy aimed at reducing energy consumption by 20% in 2020 and increasing share of renewable energy in consumption by 20% Products that meet the requirements of ErP (Energy Related Products) will be more efficient and more reliable for the customer.

The following table shows the conditions for compliance of the motor, fan and ventilation units.

	IEC-MOTORS Regulation 640/2009	FANS Regulation 327/2011 Suction Channel + Wheel+ motor + Control Unit if any	VENTILATION UNITS Regulation 1253/2014 (Ventilation Units) Regulation 1254/2014 (Labeling for Domestic Products)
2018			Increasing Requirements for all ventilation units Removal of the lowest energy class F,G
2017	IEC-motors 0.75 - 375 kW Efficiency Class: IE3 or IE2 + FU *		
2016			Minimum requirements for ventilation units with bigger than 30 kW input power Labeling for Domestic Products
2015	IEC-motors 7.5-375kW Efficiency Class: IE3 or IE2 + FU *	Fans ≥125W Minimum Efficiency 2. step	
2013		Fans ≥125W Minimum Efficiency 1. step	
2011	IEC-motors ≥ 0.75 kW Efficiency Class: IE2		

Electric Motor Efficiency - 640/2009 Regulation

Ecodesign directive seeks the following requirements for IEC electric motors;

- Starting from 2015, motors with output power between 7.5 and 375 kW cannot be more inefficient than IE3, or they have to provide IE2 level by using variable speed driver.
- Starting from 2017, Motors between 0.75 and 375 kW cannot be more inefficient than IE3, or they have to provide IE2 level by using variable speed driver.

This regulation does not include the following engines:

- Motors specifically operating under the following conditions:
- Motors operating above 1000 meters above sea level
- Motors operating in environments with an ambient temperature greater than 40 °C
- Motors with a maximum operating temperature above 400 °C
- Motors operating in environments with an ambient air temperature below -15 °C or motors running below 0 °C on air-cooled engines.
- Motors operating in potentially volatile environments as defined in Directive 94/9/EC.

Fan Efficiency - 327/2011 Regulation

Formulations and fan classifications are given for target efficiency values in fans according to Regulation No. 327/2011.

Fan Types	Measurement Category	Efficiency Category	Power Range P- kW	Target energy efficiency	Efficiency Rating (N)
Axial Fans	A	Static	0,125 ≤ P ≤ 10	$\eta_{target} = 2,74 * \ln(P) - 6,33 + N$	40
Centrifugal fans with backward curved blades(snail)	A	Static	0,125 ≤ P ≤ 10	$\eta_{target} = 4,56 * \ln(P) - 10,5 + N$	61
Centrifugal fans with forward curved and radial blades	A	Static	0,125 ≤ P ≤ 10	$\eta_{target} = 2,74 * \ln(P) - 6,33 + N$	44

*Erp regulation 327/2011 includes fans with housing.

Fans outside the ErP 327/2011 Regulation:

- Fans powered by less than 125 Watt
- Temperature of the air or gas carried over 100 °C

Requirements for Ventilation Units - 1253/2014 Regulation

If the fans are used with a structural change that will affect the flow such as any case, cabinet, hat, etc., the product is called the ventilation unit according to the regulation 1253/2014.. Many duct fans,cabinet fans and roof fans are within the scope of this regulation.

Venlatilation Units Classifications

Domestic	Based on Manufacturers Option	Not Domestic
0-250 (m³/h)	250-1000 (m³/h)	1000+ (m³/h)

The BVN product range includes domestic and non-domestic ventilation units. The ventilation units must meet the minimum requirements specified by the regulation.

Non Domestic ventilation units ERP requirements

Criteria	ErP 2016 Target Efficiency	ErP 2018 Target Efficiency
Multi-Speed Drive or Variable-Speed Drive	Necessary	Necessary
Minimum Fan Efficiency, %	$6,2\% * \ln(P) + 35,0\%$	$6,2\% * \ln(P) + 42,0\%$

*P: The input power while fan operates at maksimum efficiency point

Ventilation units must satisfy the above mentioned efficiency values for ErP compliance.

All ventilation units other than with counterflow (units that perform suction and supply ventilation simultaneously) must be equipped with a speed-changing motor or speed controller.

- EC motorized fans are suitable for the regulation.
- Air conditioning units operating at a minimum of 3 stages comply with this scope..
- Operating with single-phase or three-phase AC motor units,must be operated with voltage regulator or frequency inverter.
- Counterflow ventilation units, must be equipped with a heat recovery and bypass system.
- As of 01.2018, there must be a visual signal for pollution warning in filtered ventilation units.

This arrangement does not apply to the following ventilation units:

- When the Electrical input power is less than 30 W
- Only radial and axial fans with housing
- Atex Fans
- Fans used for smoke exhaust with single stage
- Over 100 ° C of transported gas or air
- Operating environment above 65 °C
- Air or gas transported in the working environment is below -40 °C. Besleme geriliminin 1.000 V AC veya 1.500 V DC olması
- Fans with aggressive gases
- Air handling units for heat recovery including heat exchangers and heat pumps
- When fans are used in kitchen hoods.

Requirements for the domestic ventilation units:

- Specific Energy Consumption (SEC-specific energy consumption) as of 01.2018 should be less than 20 kWh / (m2.a)
- All ventilation units must have a multi-speed or speed control unit.
- Double flow ventilation units should be equipped with heat recovery and bypass system.
- Filtered ventilation units must have a visual signal for filter pollution warning..

SEV-Class	SEV - kWh/a.m²
A+ (Most Efficiency)	SEV < - 42
A	- 42 ≤ SEV - 34
B	- 34 ≤ SEV - 26
C	- 26 ≤ SEV - 23
D	- 23 ≤ SEV - 20
E	- 20 ≤ SEV - 10
F	- 10 ≤ SEV - 0
G (Lowest Efficiency)	0 ≤ SEV

AUTOMATION AND CONTROL TECHNOLOGIES

BVN Smoke Evacuation Automation Systems Nowadays, mechanical smoke evacuation is solved by Jet Fan systems especially in car parks and tunnels. This system thanks to the momentum generated by jet fans parking lot shelter, tunnel etc. provides control of the toxic gases in the closed areas and access to the evacuation points.



Smoke extraction system, covers all mechanical, electrical and automation systems. The main components of the system are as follows;

Smoke Extraction Fans

- Fresh Air Fans
- Jet fans
- Types of smoke and air dampers
- Electrical and automation panel
- CO2, Temperature, Air Quality Censors

Smoke extraction systems;

- Parking Lots
- Highways and subway tunnels
- Factory and workshops
- Malls, restaurants, shops
- Atriums
- Homes
- Stair and emergency lift sleeves
- Used in mines and many similar structures.

Smoke evacuation system moves with other fire systems. It receives information from the fire detection system and fire extinguishing system and accordingly operates the related fire scenario

Smoke Evacuation Systems have two main uses. The first one is the evacuation of the exhaust gases of the vehicles and the second is the control and evacuation of the smoke caused by the fire.

BVN R&D

We use the finite element analysis methods for all of our fans who are introduced into our R-D and P-D processes. The strength, fatigue, thermal strength, aerodynamic performances and sound levels of the fans we design are first tested with Finite Element Analysis. In this process which is included in the design process, optimizations are continued until optimum design is achieved. Once the optimal design is achieved, the results are verified in our test centers.

Softwares Used In BVN

- **Design:** SolidWorks, Autocad
- **Analysis:** Ansys CFX
- **Production:** Powermill, Cadman, Lantek

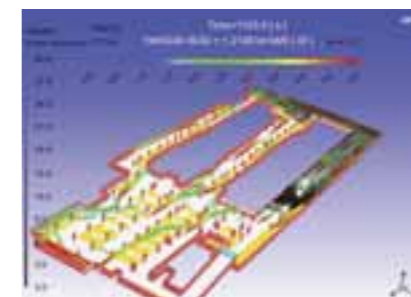
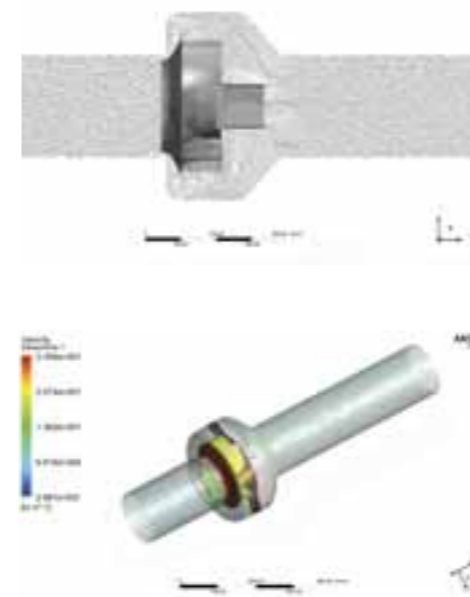

FOLLOWED STANDARTS

Management Quality
ISO 9001:2015

Test Standards

ISO 5801 Industrial fans – Performance testing using standardized airways
AMCA 210-99 Laboratory Methods of Testing Fans for Aerodynamic Performance Rating
ISO 13350 Industrial fans – Performance testing of jet fans
ISO 13348 Industrial fans – Tolerances, methods of conversion and technical data presentation

High Temperature Resistant Fan Standards

EN 12101-3:2015 Smoke and heat control systems
Part 3: Specification for powered smoke and heat exhaust ventilators

Acoustic Standards

ISO 13347-3 Acoustics Industrial fans – Determination of fan sound power levels under standardized laboratory conditions – Part 3: Enveloping surface methods

Balance and Vibration Standards

ISO 1940-1 Mechanical vibration – Balance quality requirements for rotors in a constant (rigid) state
Part 1: Specification and verification of balance tolerances
ISO 14694 Industrial fans – Specifications for balance quality and vibration levels

Safety (EC Declaration of Conformity)

EN ISO 12100-1 Safety of machinery – Basic concepts, general principles for design
Part 1: Basic terminology, methodology
EN ISO 12100-2 Basic concepts, general principles for design
Part 2: Technical principles
EN 60204-1 Electrical equipment of machines
Part 1: General requirements
EN 60335-1 Safety rules - For electrical appliances used in households and similar areas
Part 1: General rules
EN 60335-2-80 Safety rules - Part 2-80 for electrical appliances for household and similar use:
Particular requirements for ventilators
EN 294 Safety of machinery; safety distances to prevent danger zones from being reached by the upper limbs
ISO 13857 Safety of machinery – Safety distances to prevent danger zones being reached by upper and lower limbs
ISO 12499 Industrial fans – Mechanical safety of fans – Guarding

Directives

Directive 2006/42/CE Machinery Directive
Directive 2006/95/CE Low Voltage Directive
Directive 2004/108/CE EMC (Electromagnetic Compatibility) Directive
Directive 89/106/CE Construction Products Directive (CPD)
Directive 2009/125/CE Eco-design Requirements for Energy-related Products Directive

ATEX Standards

Directiva ATEX 94/9/CE Equipment and protective systems intended for use in potentially explosive atmospheres
EN 14986 Design of fans working in potentially explosive atmospheres
EN 13463-1 Non-electrical equipment for use in potentially explosive atmospheres
Part 1: Basic method and requirements
EN 1127- Explosive atmospheres - Explosion prevention and protection
Part 1: Basic concepts and methodology
EN ISO 80079-37 Explosive atmospheres
Part 37: Non-electrical equipment for explosive atmospheres – Non-electrical type of protection constructional safety "c", control of ignition sources "b", liquid immersion "k"
EN ISO 80079-36 Explosive atmospheres – Part 36: Non-electrical equipment for explosive atmospheres – Basic method and requirements



FAN SELECTION PROGRAM - FSP

With our fan selection program you can easily find the right product and working points without wasting any time. You can also compare the products, examine the technical documents about the products and print them out. To explore The World of BVN Fans: www.bvnair.com



BVN - BIM (Building Information Modelling)

Bvn Is One In The World With BIM Objects Library

Technology and innovation pioneer BVN, was one of the pioneers in the world who prepared the BIM Objects for all models. Engineers from many different parts of the world can now easily use BVN models in project work. BIM (Building Information Modeling) is a platform used as intelligent building modelling for all products of BVN, modeling was completed at the end of a long and hard work and started to be published in international libraries.

In BVN BIM file, you can find all types, dimensions and parametric properties of your model and define your company information to your digital model.

100% accurate and fast, you can take the quantity of all your products in the project together with the parametric properties you want, you can customize the meter table so that you can use it for other needs such as Facility Management during maintenance times.

FAN SELECTION

The information which should be obtained by fan manufacturer from the facility authorizer for a right fan selection,

1. Air flow rate (m³/h ,m³/s veya CFM),
2. Static and total pressure required in the operation conditions (Pa or mmSS),
3. The temperature of air (°C) passing through the fan,
4. The features of air to be carried by the fan (dust, humidity, wood chips etc.),
5. Whether the air passing through the fan is corrosive or not,
6. The permanent or temporary operation of business enterprise.

Air Flow Rate (m³/h) = Air Change Coefficient (1/hour) X Location Volume (m³)

LOCATION	AIR CHANGE COEFFICIENT (1/Hour)	LOCATION	AIR CHANGE COEFFICIENT (1/Hour)
Auditoriums	6-8	Laundries	10-20
Classrooms	5-8	Offices	4-8
Libraries	4-5	Indoor Swimming Pools	3-4
Paint Furnaces	25-50	Restaurants	8-12
Safe Box Rooms	3-6	Conference Rooms	6-8
Cinemas and Theatres	5-8	Waiting Rooms	4-6
Domestic Kitchens	15-25	Photocopy Rooms	10-15
Commercial Kitchens	15-30	Machinery Rooms	10-40
Bathrooms	5-7	Stores	4-8
Domestic wcs	4-5	Dry Cleaning	5-15
General wcs	8-15	General Malate Sites	4-8
Meeting Halls	6-8	General Change Rooms	6-8
Foundries	8-15	Rolling Mill	8-12
Gyms	4-6	Laboratories	8-15

In the characteristic curve of fan following : The operation point of the fan operating in the air flow rate of 150 m3/h and under the pressure of 162 Pa is indicated in the green area. The red area on the top part of the characteristic curve of fan is the one which is not appropriate for fan selection. The curves are formed by subjecting each fan model to flow rate and pressure tests and by entering the obtained data into the coordinate axis. The fan curves were formed as static pressure-flow rate axis in order to ease the fan selection. The maximum air flow rate given in the technical specifications is the flow rate under zero static pressure state. This is also called as the free shot state of the fan. During selection, the closest operation point must be taken into consideration. Attention must be paid to make selection from top and bottom limit points of the curve.

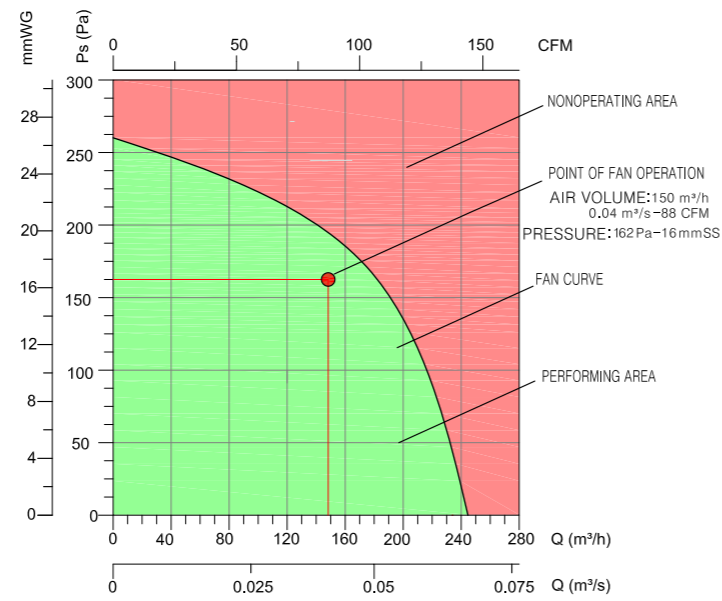

CHARACTERISTIC CURVES OF BELT AND PULLEY DRIVEN FANS

EXAMPLE FAN CURVE READING

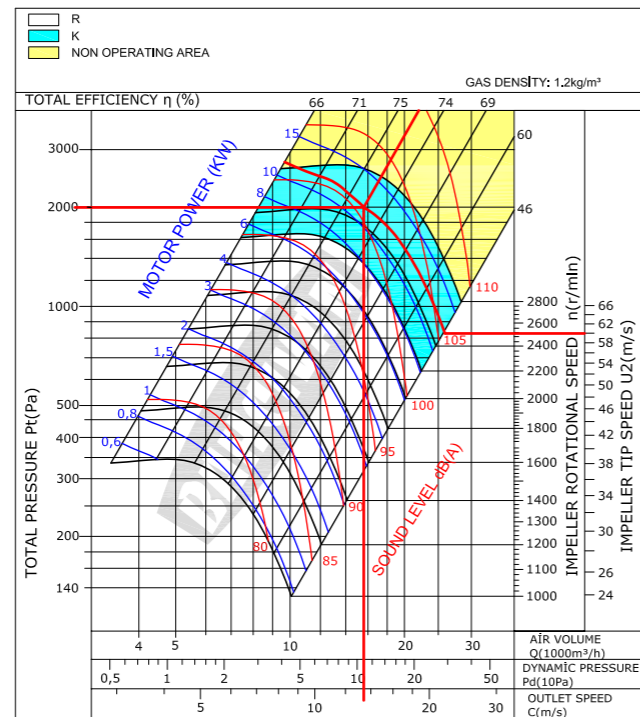

AIR VOLUME $V = 16000 \text{ m}^3/\text{h}$
 TOTAL PRESSURE $P_t = 2000 \text{ Pa}$
 DYNAMIC PRESSURE $P_d = 110 \text{ Pa}$
 OUTLET SPEED $C = 13,5 \text{ m/s}$
 NUMBER OF SPEED $n = 2500 \text{ d/d}$
 BLADE SPEED $U_2 = 60 \text{ m/s}$
 POWER $P_w = 12 \text{ Kw}$
 SOUND LEVEL $L_{wi} A = 102 \text{ dB(A)}$
 EFFICIENCY $h = \% 74,5$

UNSTABLE WORKING FIELD IN FANS

Fan users always demand constant and continuous flow ventilation systems. In this case, the pressure generated by the fan is constant, but in performance curves there are unstable working zones which differ according to the structure of the fans. If the operating point is selected in this area, there will be fluctuations in the ventilation system. The reason for this is; irregular flow and flow breaks on the wing.

Choice in the unstable field;

- Increase in the amount of vibration
- Volume level increase
- Dynamic fatigue occurs in the structure of the fan due to the fact that it works with a shot and the amount of vibration increases.
- Damage to ducts and other connected systems
- Wing efficiency is reduced because the fan system does not operate properly.
- In order to avoid these unstable operations when selecting the fan, the unstable zone points of some of our products in our fan curves have been removed from the performance curve.

To reach high efficiency and to avoid unstable operate zones, Fan selection should be in range of maximum flow;

- For Backward Curved Fans: %30-%70
- For Forward Curved Fans: %40-%85
- Airfoil Wing Fans: %50-%85
- Fans with Radial Wings: %35-%80
- Tube Axial Fans: %60-%90

The graph on the right shows the performance curve of a backward curved radial fan. The operating point to be chosen from the optimum area of use means high hydraulic power, low energy consumption, high efficiency and low noise.

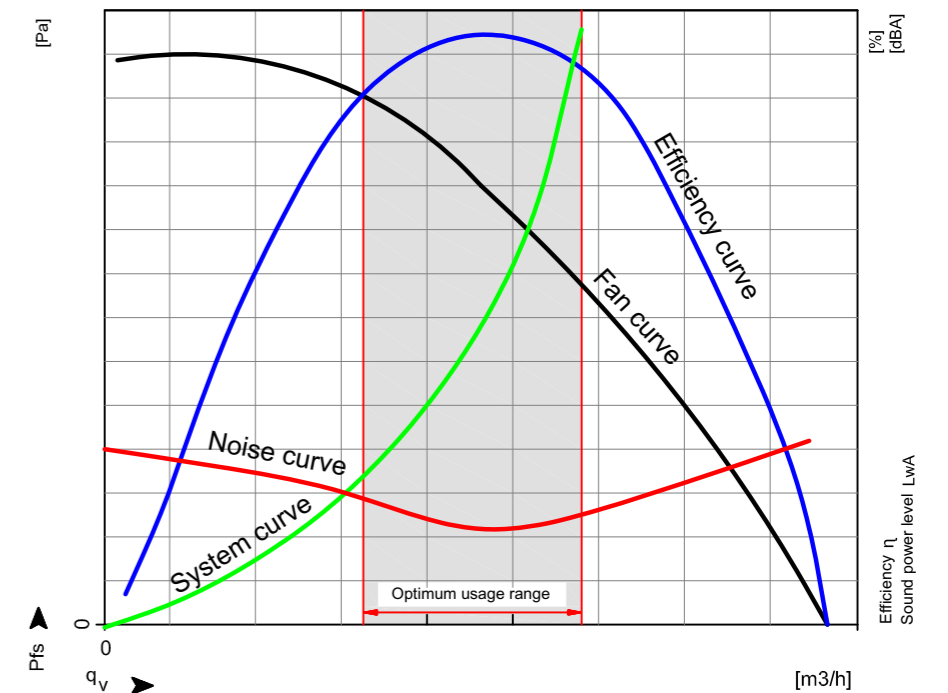

ARMO JET FAN CODE DESCRIPTIONS

ARMO - JP355 - 80 / UL / 2 - 4A (F400)

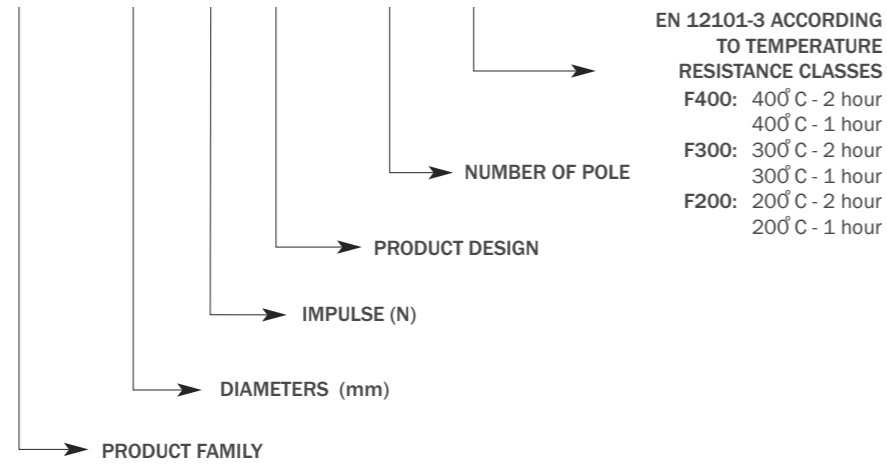

NUMBER OF POLE

ARMO - JP355 - 80 / UL / 2 - 4A (F400)

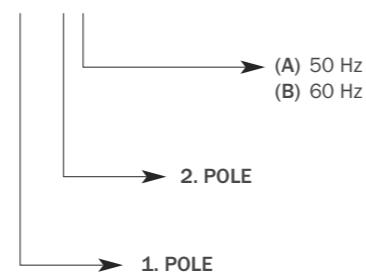

PRODUCT DESIGN

ARMO - JP355 - 80 / UL / 2 - 4A (F400)

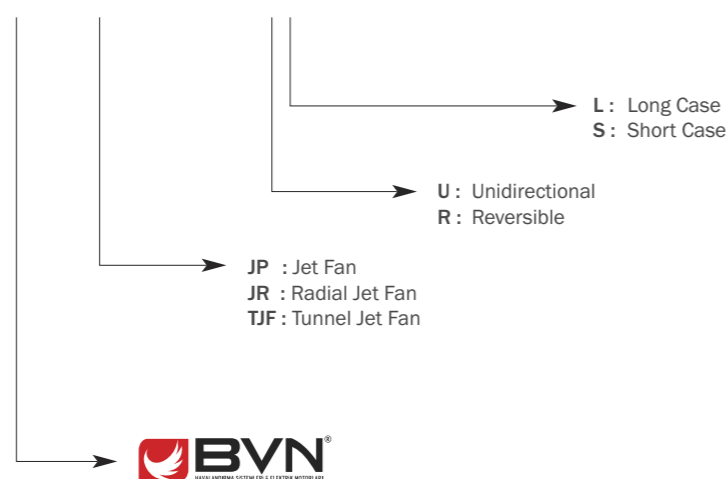

ARMO AXIAL FAN CODE DESCRIPTIONS

ARMO - A800 / UL / 6-45 / 30-15 / 2-4A (F400)

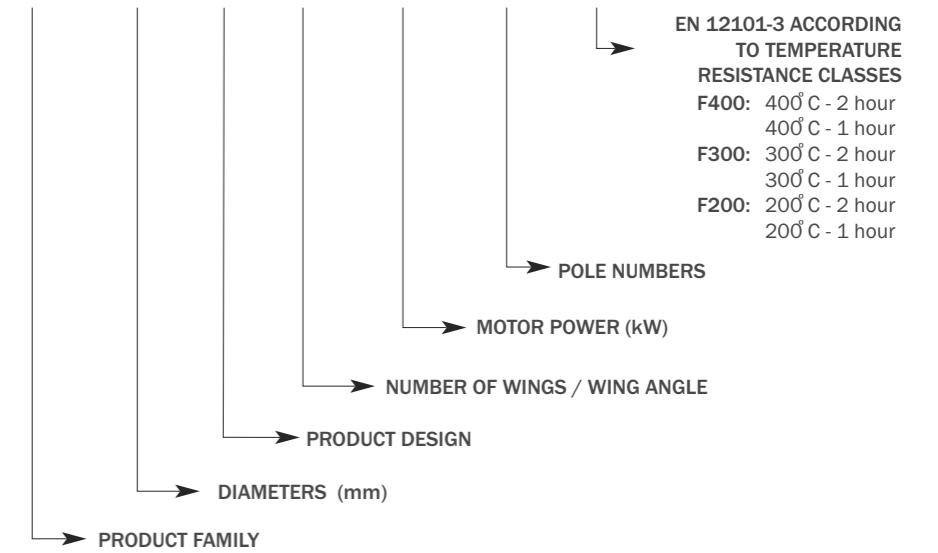

NUMBER OF POLE

ARMO - A800 / UL / 6-45 / 30-15 / 2-4A (F400)

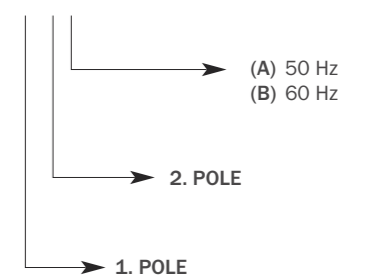

PRODUCT DESIGN

ARMO - A800 / UL / 6-45 / 30-15 / 2-4A (F400)

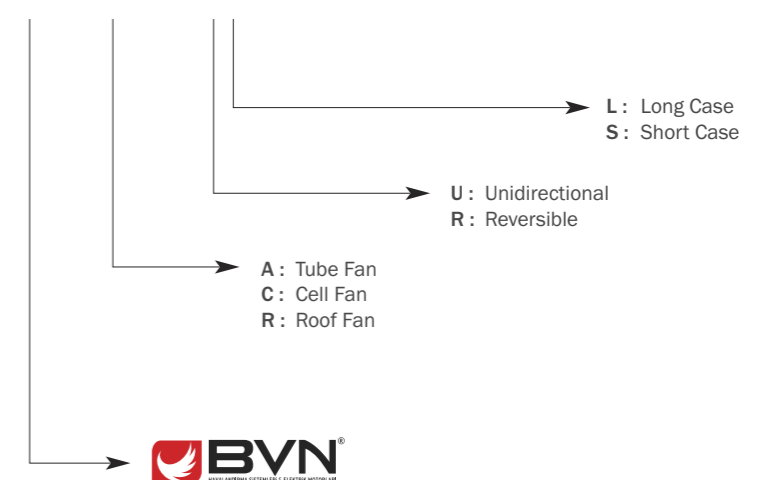

FLOW, PRESSURE, POWER UNITS CONVERSION TABLES

Flow Units

Unit	Unit Names	m³/s	m³/min	m³/h	l/h	l/s	ft³/scu.ft/s	ft³/mincu.ft/min
1 m³/s	cubic meters / second	1	60	3600	3.6*10 ⁶	1000	35.31	2118.8
1 m³/min	cubic meters / minute	0.01667	1	60	6.0*10 ⁴	16.667	0.5885	35.31
1 m³/h	cubic meters / hour	2.778*10 ⁻⁴	0.01667	1	1000	0.2778	9.808*10 ⁻³	0.5886
1l/h=1dm³/h	liters / hour	2.778*10 ⁻⁷	1.667*10 ⁻⁵	0.001	1	2.778*10 ⁻⁴	9.808*10 ⁻⁶	5.886*10 ⁻⁴
1 l/s = 1 dm³/s	liters / second	0.001	0.05999	3.5	3600	1	3.531*10 ⁻²	2.1188
1 cu.ft/s(cfs)	cubic feet / second	2.932*10 ⁻²	1.6992	102	1.02*10 ⁵	28.3179	1	60
1cu.ft/min(cfm)	cubic feet / minute	4.179*10 ⁻⁴	2.832*10 ⁻²	1.70	1.70*10 ³	0.47197	1.667*10 ⁻²	1

Pressure Units

Unit	Unit Name =N/m²	Pa	bar	mbar = mmWs	kp/m² = at	kp/cm²	atm mHg	Torr=m	lbf/in²	lbf/ft²	in Hg
1 Pa = 1N/m²	Pascal	1	0.00001	0.01	0.10197	0.00001	-	0.0075	0.00014	0.02089	0.000295
1 bar	Bar	100000	1	1000	10197.2	1.01972	0.98692	750.062	14.5037	2088.54	29.53
1 mbar	Millibar	100	0.001	1	10.197	0.00102	0.000987	0.750	0.01450	2.08854	0.02953
1 kp/m²=1mm.WS	mm Su Sütunu	9.80665	-	0.09807	1	0.0001	-	0.07356	0.00142	0.20482	0.0029
1 kp/cm²=1at	Technical Atmosphere	98066.5	0.98067	980.66	10000	1	0.96784	735.559	14.2233	2048.16	28.959
1 atm	Physical Atmosphere	101325	1.01325	1013.25	10332.3	1.03323	1	760	14.696	2116.22	29.9213
1 torr=1mmHg	mm Mercury Column	133.322	0.00133	1.3332	13.5951	0.00136	0.00132	1	0.01934	2.78449	0.03937
1 lbf/in²	Force per square inch	6894.76	0.06895	68.9476	703.07	0.07031	0.06805	51.7149	1	144	2.03602
1 lbf/ft²	Feet per square foot	47.8803	0.00048	0.47880	4.88243	0.00048	0.00047	0.35913	0.00694	1	0.01414
1 in Hg	Inch mercury column	3386.39	0.03386	33.8639	345.316	0.03453	0.03342	25.4	0.49115	70.7262	1
1 in H ₂ O	Inch Water Column	249	0.00249	2.4909	25.4	0.00254	-	1.8684	0.0315	5.2024	0.07366

IP PROTECTION CLASSES

DEGREE	SYMBOL	DESCRIPTION
0		non protected
1		protected against solid foreign objects of 50mm ø and greater and against access to hazardous parts with the back of a hand protected against solid foreign
2		objects of 12.5mm ø and greater and against access to hazardous parts with a finger
3		protected against solid foreign objects of 2.5mm ø and greater and against access to hazardous parts with a tool
4		protected against solid foreign objects of 1.0mm ø and greater and against access to hazardous parts with a wire
5		dust-protected and protected against access to hazardous parts with a wire
6		dust-tight and protected against access to hazardous parts with a wire

DEGREE	SYMBOL	DESCRIPTION
0		non protected
1		protected against vertically falling water drops
2		protected against vertically falling water drops when enclosure tilted up to 15°
3		protected against spraying water
4		protected against splashing water from any direction
5		protected against water jets
6		protected against powerful water jets

CODES	CONNECTION DIAGRAM TYPE																			
	1	2	3	4	5	6	7	8	9	10	11	12	13	14	15	16	17	18	19	20
BDRKF 160-M	•																			
BDRKF 180-M	•																			
BDRKF 220-A-M	•																			
BDRKF 220-B-M	•																			
BDRKF 225-M	•																			
BDRKF 250-M	•																			
BDRKF 280-M	•																			
BDRKF 315-M	•																			
BDRKF 355-M	•																			
BDRKF 400-M			•																	
BDRKF 450-M			•																	
BDRKF 500-M		•																		
BDRKF 500-T		•																		
BDRKF 560-M		•																		
BDRKF 560-T		•																		
BDTX 100	•																			
BDTX 125	•																			
BDTX 150	•																			
BDTX 160	•																			
BDTX 200-A	•																			
BDTX 200-B	•																			
BDTX 250-A	•																			
BDTX 250-B	•																			
BDTX 315-A	•																			
BDTX 315-B	•																			
BDTX 355-A	•																			
BDTX 355-B	•																			
BPX 150	•																			
BFTX 100	•																			
BFTX 150-B	•																			
BFTX 200-B	•																			
BFTX 250-B	•																			
BFTX 315-B	•																			
BMFX 100/2V																			•	
BMFX 125/2V																			•	
BMFX 150/2V																			•	
BMFX 200/2V																			•	
BMFX 250/2V																			•	
BMFX 315/2V																			•	
BDKF 30-15	•																			

CODES	CONNECTION DIAGRAM TYPE																			
	1	2	3	4	5	6	7	8	9	10	11	12	13	14	15	16	17	18	19	20
BASSF 315-125		•																		
BDRAS 85-40						•														
BDRAS 108-50						•														
BDRAS 120-60	•																			
BDRAS 140-60	•																			
BDRAS 160-60	•																			
BDRS 125-50	•																			
BDRS 120-60	•																			
BDRS 140-60	•																			
BDRS 160-60	•																			
BPS 140-60	•																			
BPS-B 140-60	•																			
BPS-B 150-100	•																			
OBR 140M-2K											•									
OBR 140M-4K											•									
OBR 200M-2K												•								
OBR 200M-4K												•								
OBR 200M-2K*													•							
OBR 200T-2K				•																
OBR 200T-4K				•																
KMS (MONOFAZE)																				
KTS (TRIFAZE)																				
ALÇ (MONOFAZE)																				
ALÇ (TRIFAZE)																				
BGSS (MONOFAZE)																				
BGSS (TRIFAZE)																				
BSC-1																				
BSC-2/3																				
ALR (MONOFAZE)																				
ALR (TRIFAZE)																				
BFC 133-2K	•																			
BFC 133-4K	•																			
BGK 75	•																			
BGK 100	•																			
BGK 200				•																
BGK 300				•																
BGK 400				•																
BGK 500				•																
BKEF (MONOFAZE)																				
BKEF (TRIFAZE)																				
BKEF-T (MONOFAZE)																				
BKEF-T (TRIFAZE)																				
BKEF-R (MONOFAZE)																				
BKEF-R (TRIFAZE)																				
BKEF-RH (MONOFAZE)																				
BKEF-RH (TRIFAZE)																				
B6 PAM 250	•																			
B6 PAM 300	•																			
B6 PAM 350	•																			
B6 PAM 400	•																			
B6 PAM 450	•																			
B6 PAM 500						•														
B6 PAT 250						•														
B6 PAT 300						•														
B6 PAT 350						•														
B6 PAT 400						•														
B6 PAT 450						•														
B6 PAT 500						•														
ÇES																				
OÇES																				
SF-4M 250 B/S	•																			
SF-4M 300 B/S	•																			
SF-4M 350 B/S	•																			
SF-4M 400 B/S	•																			
SF-4M 450 B/S	•																			
SF-4M 500 B																				
SF-4MX 500B																				
SF-6M 500 B																				
SF-4M 500 S																				
SF-4MX 500 S																				
SF-6M 500 S																				
SF-4TX 300 S/B																				
SF-4T 350 S/B																				
SF-4T 400 S/B																				
SF-4T 450 S/B																				
SF-4T 500 S/B																				
SF-4TX 500 S/B																				

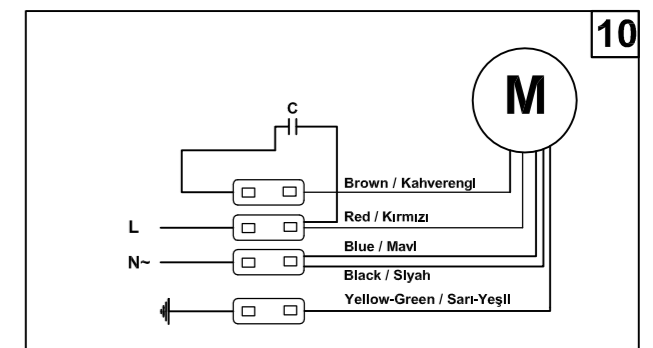
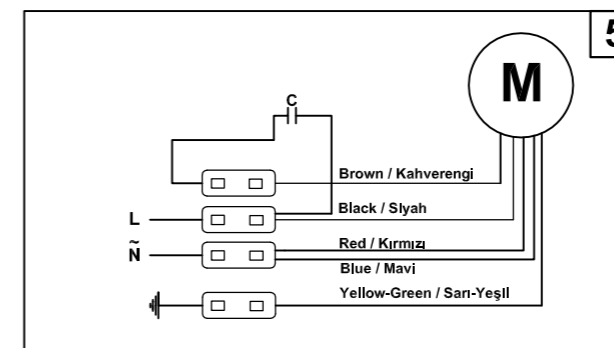
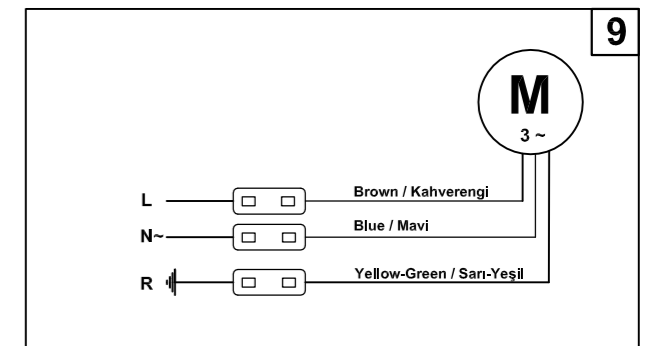
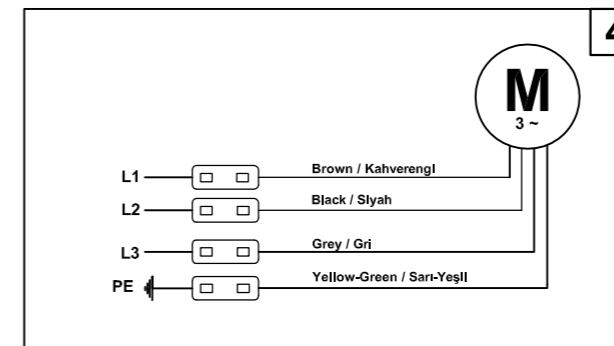
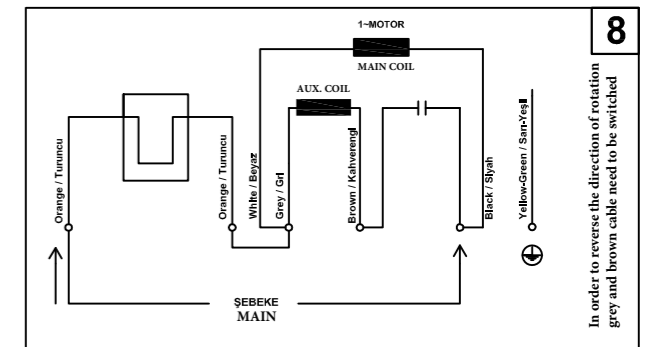
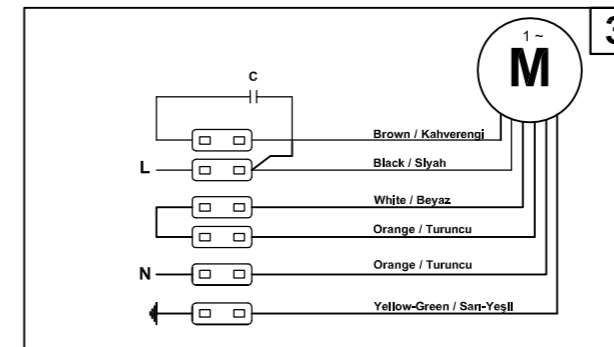
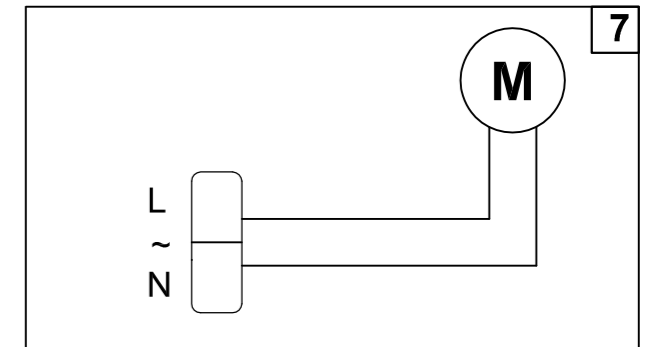
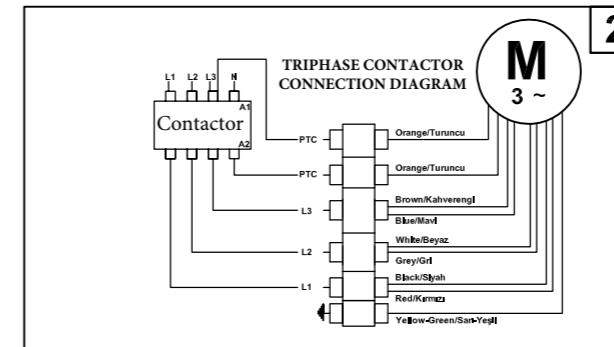
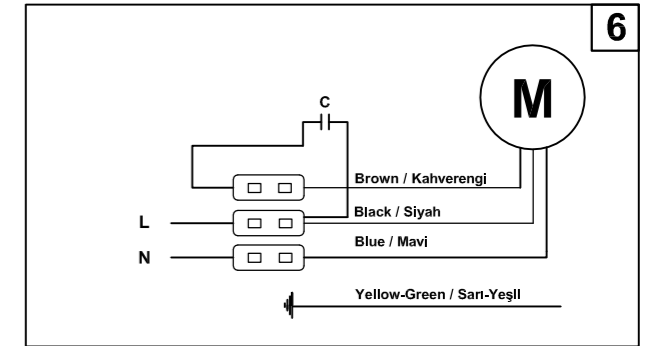
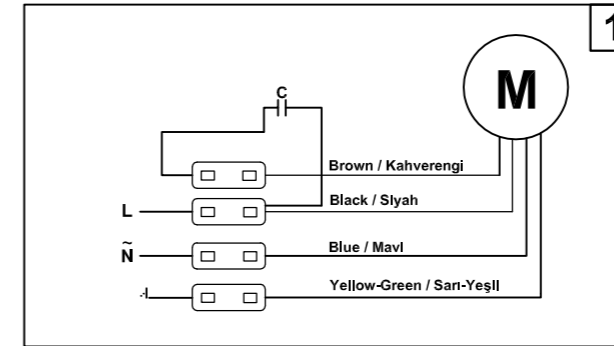

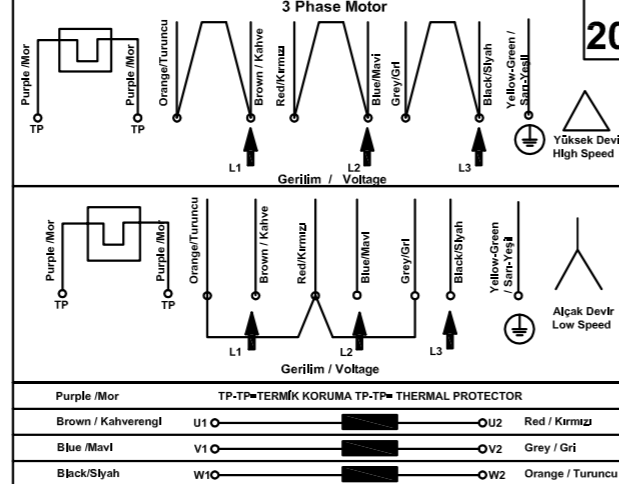
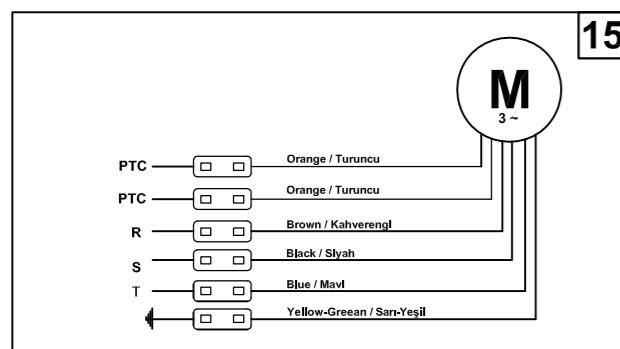
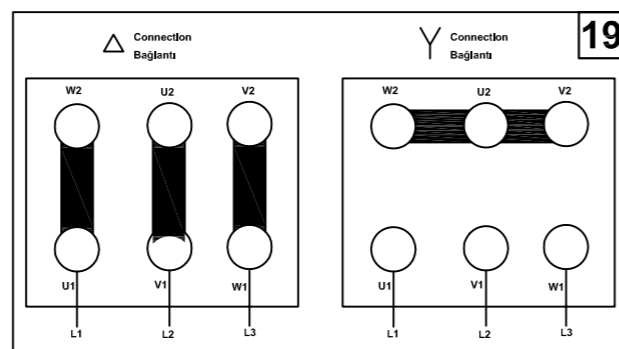
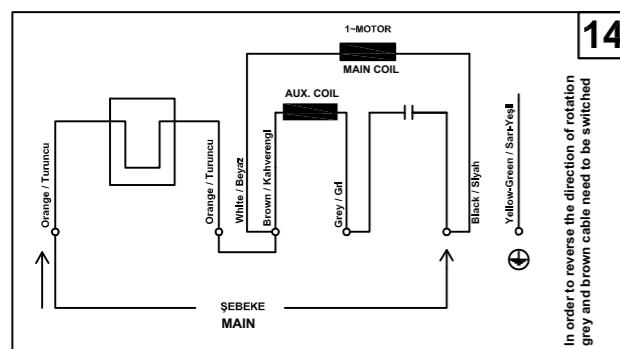
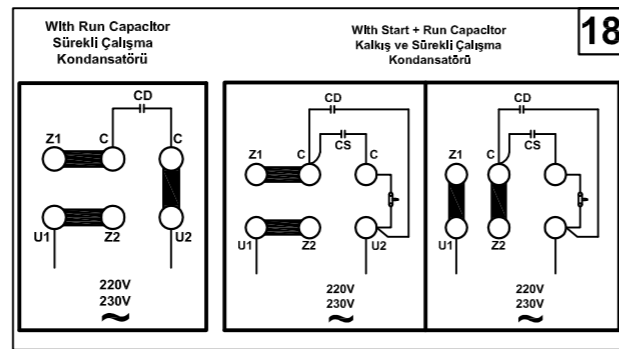
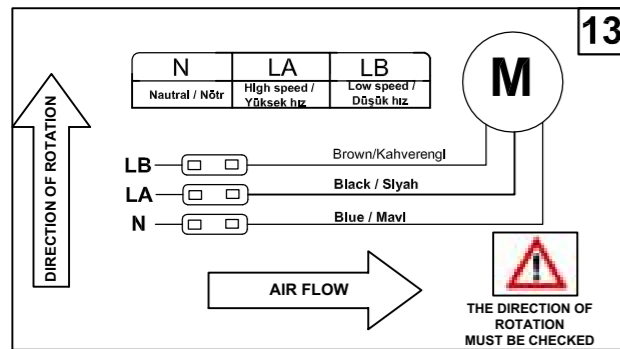
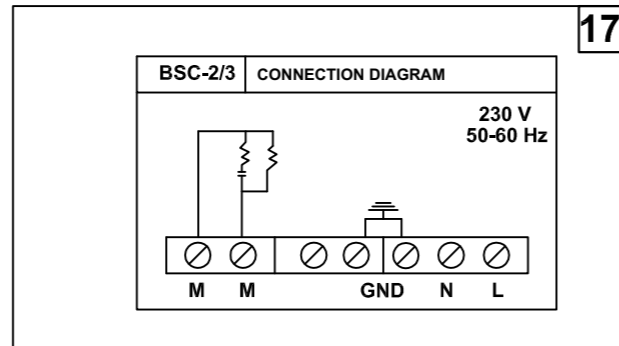
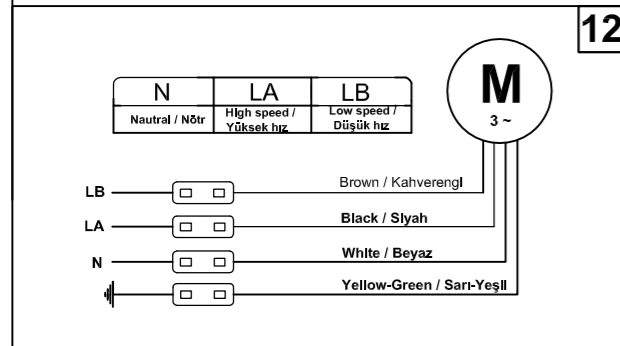
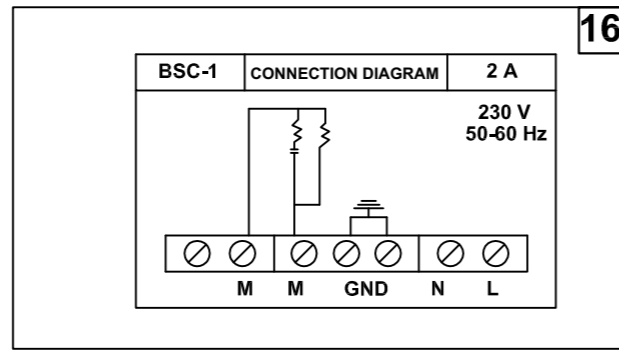
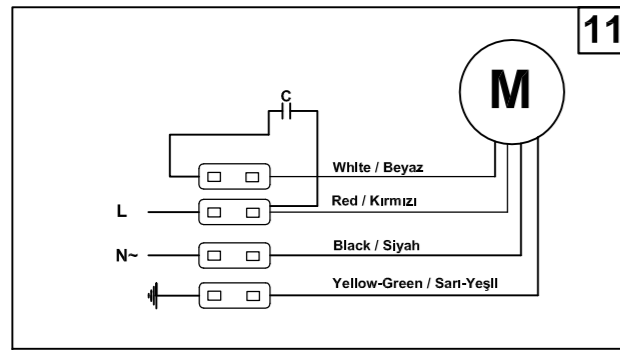

BVN continuously strengthens its production power by supporting it with automated machines, software, automation technologies, advanced maintenance techniques, production systems and Industry 4.0 applications.

PRODUCTION

BVN Has the Biggest Integrated Fan Manufacturing Facility in Eastern Europe and Middle East.

External rotor motors, wide range of fans and ventilation units are produced in BVN Facility including all components. BVN also has its own molding division. Starting from design to package, every design and component has BVN signature with valuable experienced technical team.

OUR PRODUCT

BVN fans have a wide range of products from very simple ventilation applications to offer comprehensive solutions. Our fans are divided into 6 main groups according to their structural features. In each group, wing types, wing counts, production applications, material properties, engine types, air transfer temperatures, working environments, electrical properties etc. designed to meet different needs, mainly product models are produced.

- | | | |
|--------------------------|-----------------|-------------------|
| 1. Duct Fans | 5. Exproof Fans | 9. Radial Fans |
| 2. Heat Recovery Devices | 6. EC Fans | 10. Bathroom Fans |
| 3. Haven Fans | 7. Thermo Fans | 11. Accessories |
| 4. Roof Fans | 8. Axial Fans | |

PRODUCTION FAMILIES

1. DUCT FANS

The duct fans can be easily mounted to the ventilation ducts thanks to their special compact design. Centrifugal duct fans have high pressure, low noise level, and high-efficiency values compared to axial duct fans.

2. HEAT RECOVERY DEVICES

Large amounts of energy are consumed for heating load and cooling load in order to Air-condition an ambient. It minimizes additional energy costs by minimizing heat losses with the help of plate heat exchangers without mixing the feed and exhaust air.

3. SHELTER FANS

It has two types of usage.
1. It is used as duct fan under normal conditions.
2. Time of Threat; The emergency dampers with special filters are switched on and the normal condition dampers are deactivated.

4. ROOF FANS

Due to vertical-horizontal exhaust and radial-axial fan impeller types is used a wide range of applications. It is designed in accordance with the roof vents installation.

5. EX-PROOF FANS

They are capable of meeting the high safety requirements in potentially explosive environments. All BVN Ex-Proof featured fans follow up the ATEX directive 94/9 / EC. They can be provided Ex e (safety enhanced) and Ex d (flameproof) structure and T3-T4 as temperature classes.

6. EC FANS

EC fans have become the choice of new generation applications. BVN high-efficiency EC fans introduce a new perspective to the sector using automatic control and sensors as operating options in their applications.

7. THERMO FANS

It is used to provide air and smoke transport at high temperatures with their external motor design. Smoke discharge fans, kitchen exhaust fans, and jet fans carry a thermo fan feature. Smoke extraction fans are EN 12101-3 certified.

8. AXIAL FANS

They give the best working performance with high flow rate at low pressure. They are used in applications similar to general ventilation, cooling, pressurization, car parking, and tunnel exhaust ventilation.

9. RADIAL FANS

Radial fans stand out with their high-pressure properties and high efficiency. they are suitable for use in applications like duct fans, air handling units, heating-cooling industry for hot air distribution, firing, and industrial ventilation and so on.

10. BATHROOM FANS

They are used in areas such as the bathroom, toilet, warehouse and can be easily assembled to a wall, ceiling, channel, and window.

11. ACCESSORIES

Accessories are complementary products to provide more benefits or to meet the needs of the products. Speed Control devices, frequency inverters, shutters, filters, flexible flanges, dampers, silencers, vibration springs, protective grilles and duct type heaters are our accessories.

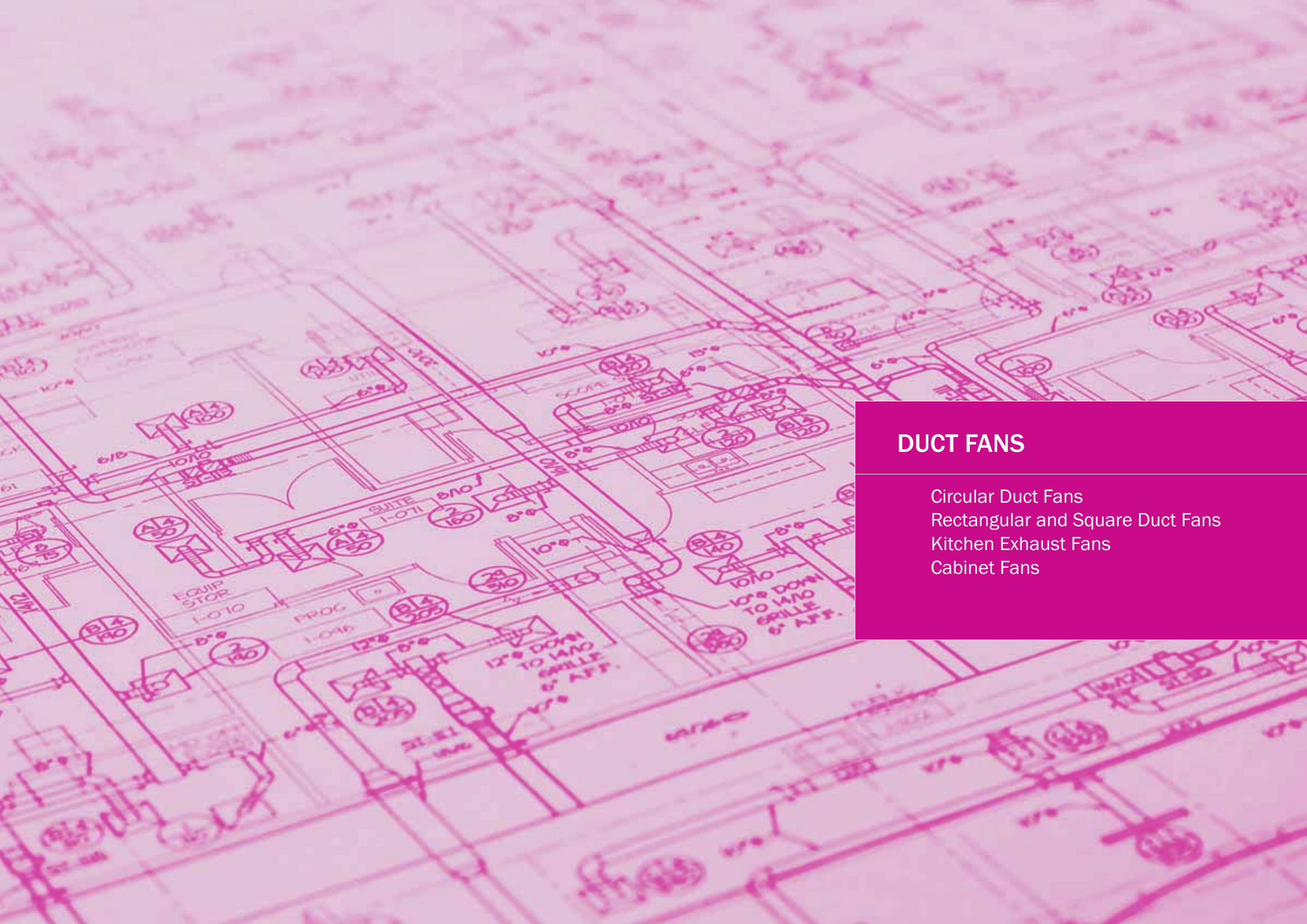

DUCT FANS

- Circular Duct Fans
- Rectangular and Square Duct Fans
- Kitchen Exhaust Fans
- Cabinet Fans

DUCT FANS

They are designed specially to connect ventilation ducts. Can be used in wide performance ranges. It is the most used fan type for different applications with its comprehensive product variety.

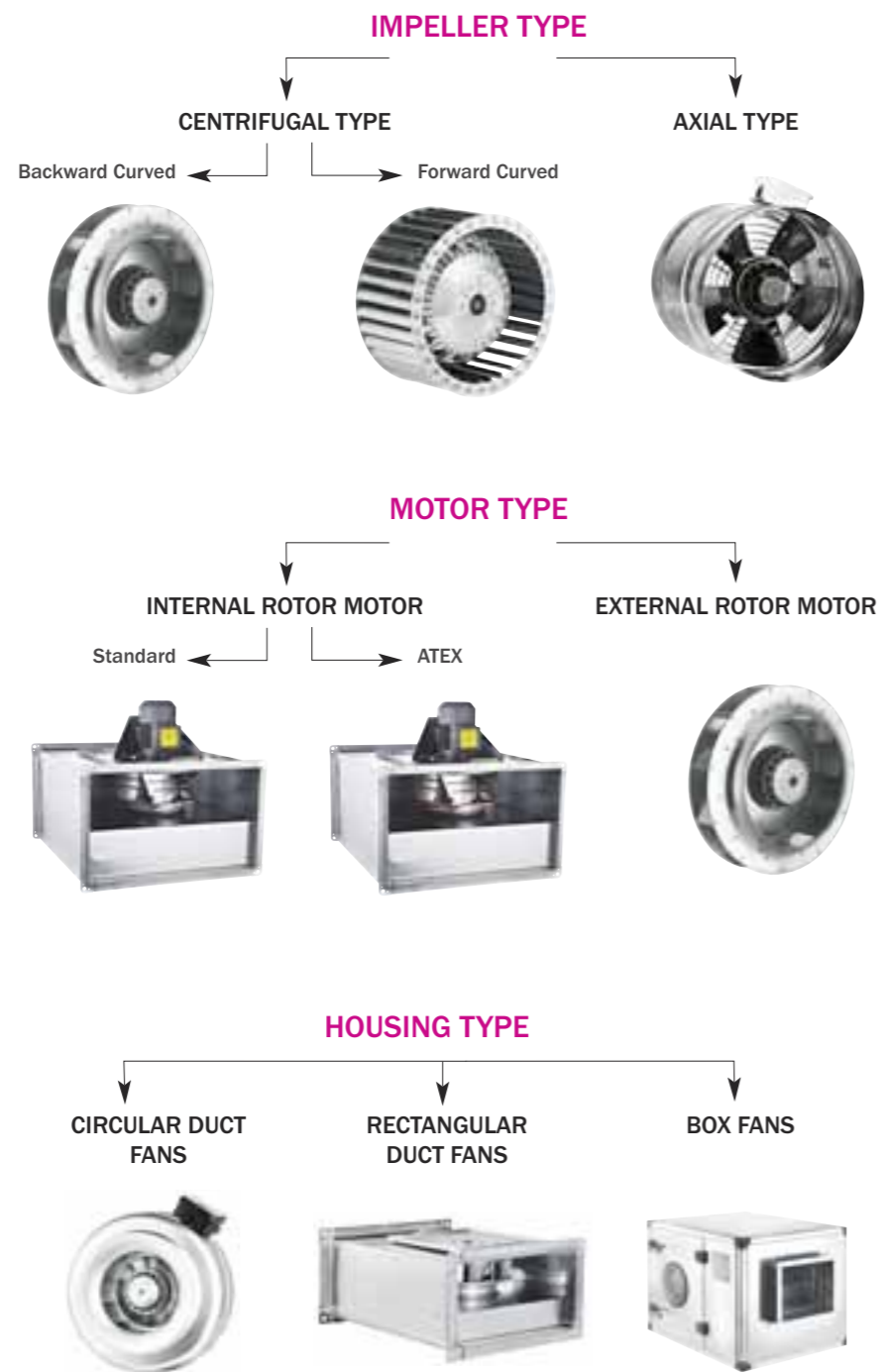



BDTX

ROUND DUCT TYPE FANS / Backward Curved

Device Components and Material Properties
The case and fan are made of high quality galvanized sheet metal which is pressed against corrosion. All models have an external rotor motor with a closed structure and have air transport at max.40°C. On request, the motor can be produced as thermally protected against high temperature. The terminal box and mounting legs are supplied with the product as standard. Suction and discharge nozzles are compatible with duct diameters and can be connected by clamp.

Fan Structure
Designed to work between round ducts. The fan blades are aerodynamically curved and provide regular flow. The fans are composed of backward sloping and infrequently arranged fins.

Benefits
The rotation of the fan on the motor housing saves efficiency and space. It works at optimum sound levels while providing strong air suction. It can be operated in any position. If necessary, it can be mounted on the wall thanks to the mounting legs. Speed can be adjusted with speed control devices.

Speed Control
Optional control devices can be provided.
* Linear voltage regulator speed control can be done. (see BSC accessory)

Usage Areas
Round duct fans are used in low and medium volume ventilation requirements in duct systems where the application area is limited. It should be used with oil holding filter in oily environments.

Technical Drawing and Tables

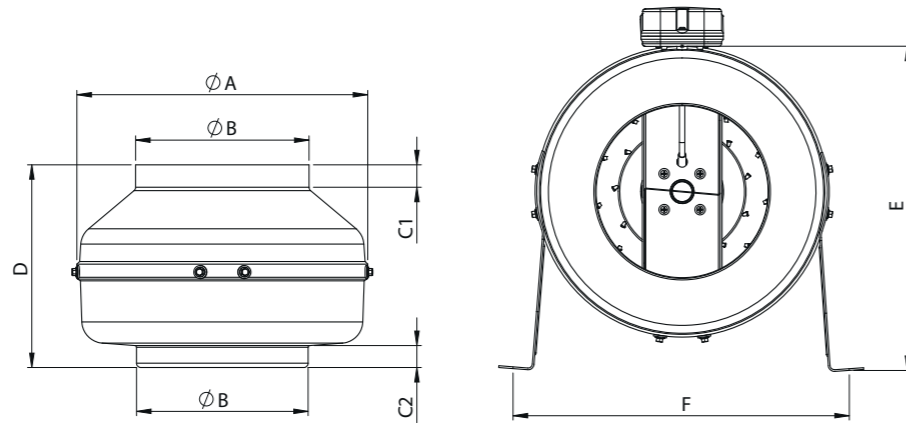

Accessories



TYPE	A	B	C1	C2	D	E	F
BDTX 100	245	97	20	20	197	273	268
BDTX 125	245	122	20	20	188	273	268
BDTX 150	272	147	23	25	192	286	295
BDTX 160	272	157	23	25	192	286	295
BDTX 200	330	196	30	28	230	380	352
BDTX 250	330	247	30	28	227	380	352
BDTX 315	400	313	30	30	285	415	422
BDTX 355	400	352	30	30	378	415	422

Dimensions are in (mm)

TYPE	VOLTAGE	FREQUENCY	POWER	CURRENT	CAPACITOR	SPEED	AIR FLOW	SOUND PRESSURE	INSULATION CLASS	PROTECTION CLASS	WEIGHT
TYPE	V	Hz	W	(A)	(µF)	r.p.m	m³/h	dB(A)	Ins.cl.	IP	kg
BDTX 100	230	50/60	60	0,3	2	2610/2960	240/275	44	B	44	2,6
BDTX 125	230	50/60	80	0,4	2,5	2325	315	43	B	44	2,7
BDTX 150	230	50/60	78	0,4	2,5	2450	420	46	B	44	3
BDTX 160	230	50/60	85	0,4	2,5	2550	440	45	B	44	3,2
BDTX 200-A	230	50/60	90	0,43	2,5	2300	735	46	B	44	4,4
BDTX 200-B	230	50/60	100/130	0,51/0,68	4	2530/2720	870/935	48	B	44	4,8
BDTX 250-A	230	50/60	140	0,69	4	2400	1010	45	B	44	4,9
BDTX 250-B	230	50/60	145/200	0,74/1,04	6	2650	1150	47	B	44	5,3
BDTX 315-A	230	50/60	160/210	0,8/1,1	6	2400	1450	48	B	44	6,8
BDTX 315-B	230	50/60	180/245	0,87/1,23	7	2500/2700	1750/1890	49	B	44	6,9
BDTX 355-A	230	50/60	160/175	1/0,85	4	1450/1700	1300/1525	45	F	44	9
BDTX 355-B	230	50	445	1,94	8	2450	2620	54	F	44	10

Sound Level Measured from 3m distance in room condition.

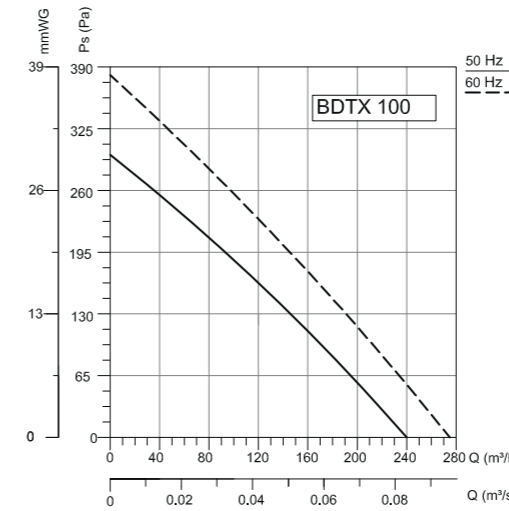

Frequency	Tot	63	125	250	500	1000	2000	4000	8000	Hz
L _{wa} Inlet	71	53	65	62	65	64	60	52	42	dB(A)
L _{wa} Outlet	68	54	64	58	62	61	58	50	40	dB(A)
L _{wa} Surrounding	51	29	17	30	47	46	45	39	27	dB(A)

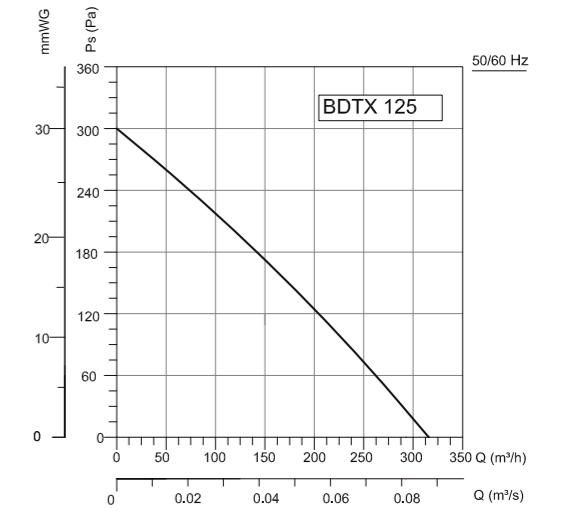

Frequency	Tot	63	125	250	500	1000	2000	4000	8000	Hz
L _{wa} Inlet	70	47	63	64	65	63	60	55	45	dB(A)
L _{wa} Outlet	68	49	62	59	62	61	58	52	43	dB(A)
L _{wa} Surrounding	50	20	20	39	45	44	43	36	30	dB(A)

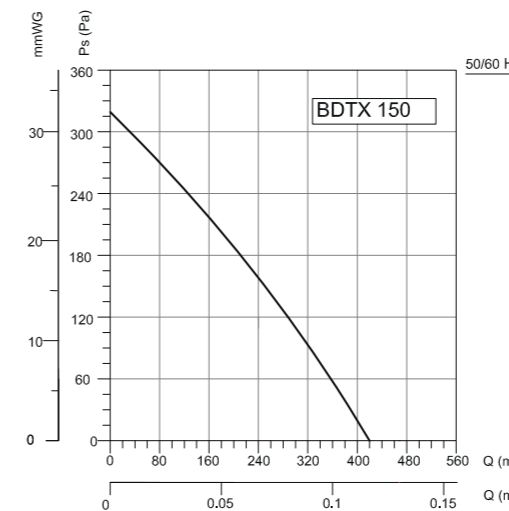

Frequency	Tot	63	125	250	500	1000	2000	4000	8000	Hz
L _{wa} Inlet	76	52	73	65	69	67	62	60	50	dB(A)
L _{wa} Outlet	74	55	71	62	68	64	62	55	50	dB(A)
L _{wa} Surrounding	53	20	35	37	50	45	46	44	32	dB(A)

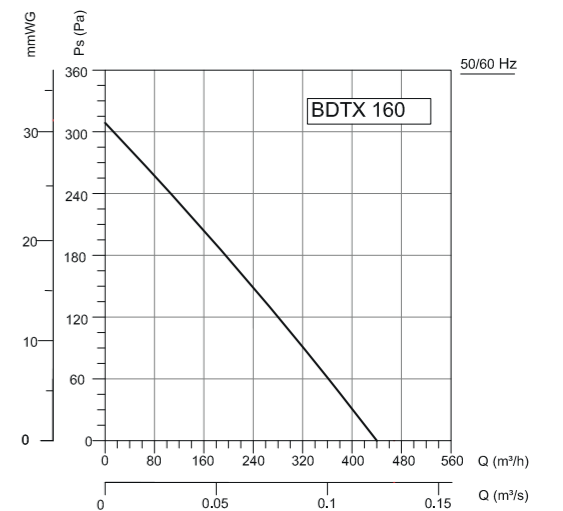

Frequency	Tot	63	125	250	500	1000	2000	4000	8000	Hz
L _{wa} Inlet	75	50	70	66	71	68	45	58	48	dB(A)
L _{wa} Outlet	76	56	74	61	69	66	62	56	48	dB(A)
L _{wa} Surrounding	52	10	32	36	48	46	45	42	28	dB(A)

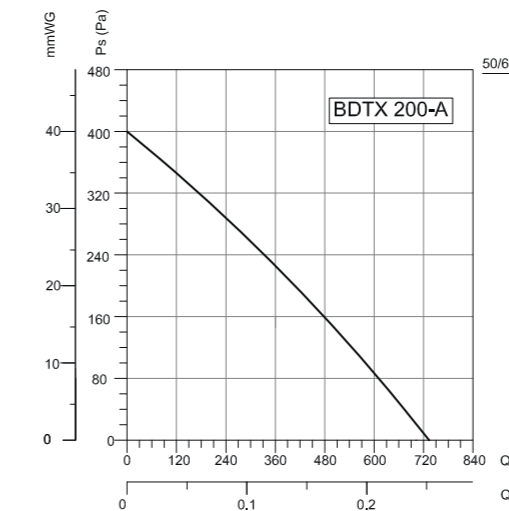

Frequency	Tot	63	125	250	500	1000	2000	4000	8000	Hz
L _{wa} Inlet	70	42	61	64	63	64	63	56	54	dB(A)
L _{wa} Outlet	71	49	59	62	65	64	64	58	53	dB(A)
L _{wa} Surrounding	53	8	25	32	45	49	47	42	38	dB(A)

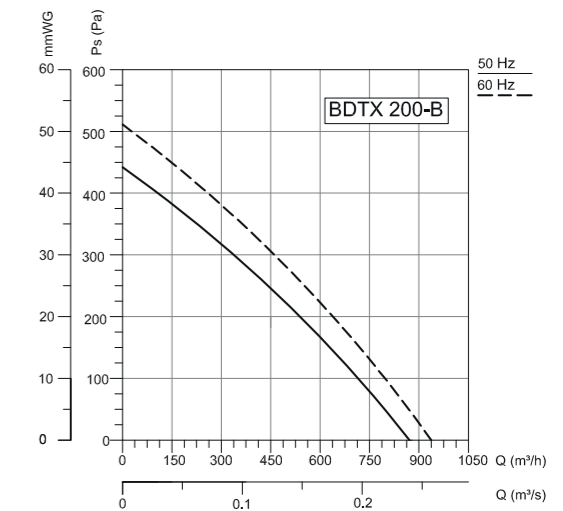

Frequency	Tot	63	125	250	500	1000	2000	4000	8000	Hz
L _{wa} Inlet	71	42	61	64	64	64	63	56	54	dB(A)
L _{wa} Outlet	72	49	60	63	66	64	66	58	53	dB(A)
L _{wa} Surrounding	54	8	35	40	47	50	47	45	40	dB(A)

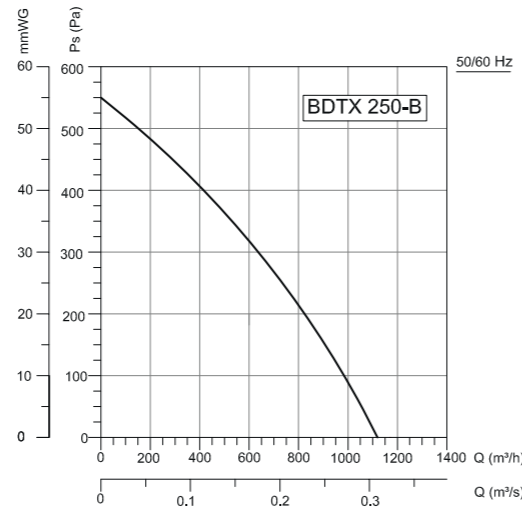
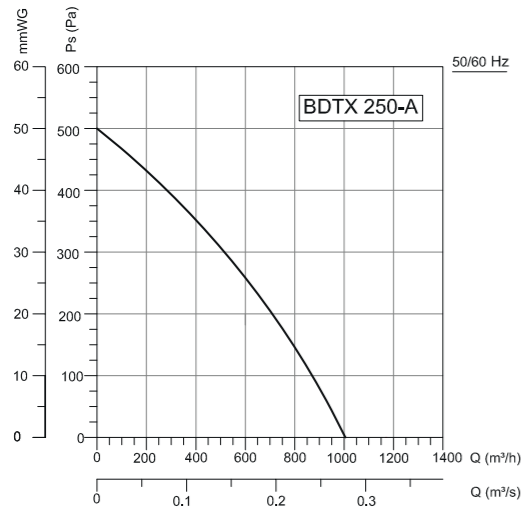

Frequency	Tot	63	125	250	500	1000	2000	4000	8000	Hz
L _{wa} Inlet	70	49	59	65	61	64	61	60	50	dB(A)
L _{wa} Outlet	71	48	60	65	61	65	63	61	51	dB(A)
L _{wa} Surrounding	52	27	28	46	45	47	45	42	30	dB(A)

Frequency	Tot	63	125	250	500	1000	2000	4000	8000	Hz
L _{wa} Inlet	70	49	59	65	62	65	61	60	50	dB(A)
L _{wa} Outlet	71	48	60	65	61	65	63	61	51	dB(A)
L _{wa} Surrounding	54	28	29	47	47	49	45	43	30	dB(A)

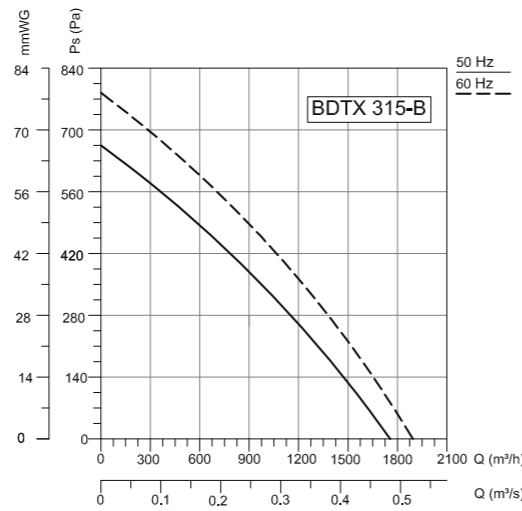
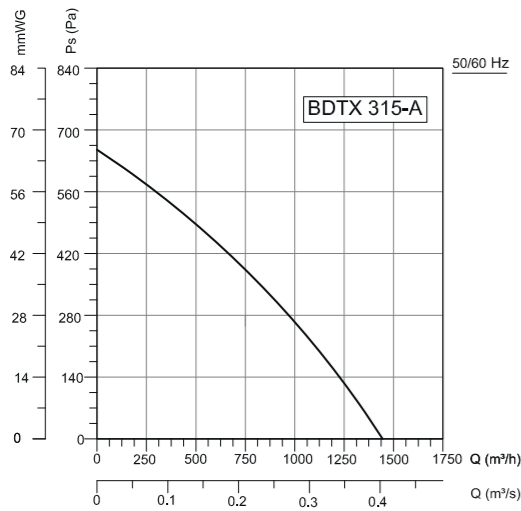

Frequency	Tot	63	125	250	500	1000	2000	4000	8000	Hz
L _{wa} Inlet	72	46	60	65	64	66	63	64	53	dB(A)
L _{wa} Outlet	73	52	60	64	63	66	67	65	55	dB(A)
L _{wa} Surrounding	54	18	25	43	47	47	50	46	34	dB(A)

Frequency	Tot	63	125	250	500	1000	2000	4000	8000	Hz
L _{wa} Inlet	75	55	66	68	70	68	66	63	58	dB(A)
L _{wa} Outlet	76	62	67	71	69	68	69	63	57	dB(A)
L _{wa} Surrounding	56	22	35	45	51	47	50	46	45	dB(A)

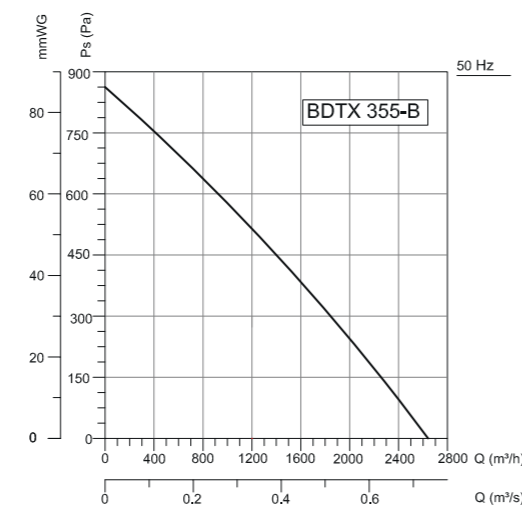
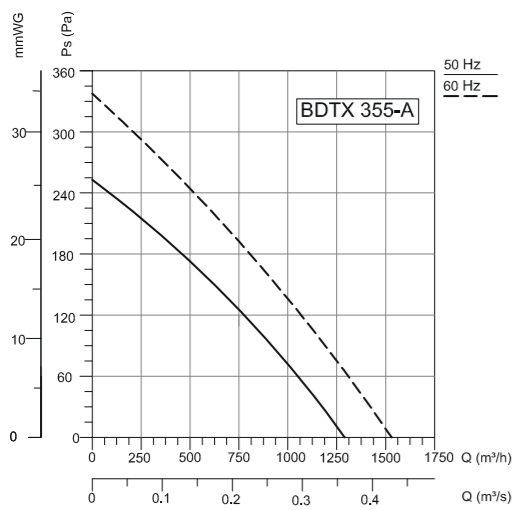

Frequency	Tot	63	125	250	500	1000	2000	4000	8000	Hz
L _{wa} Inlet	70	49	59	65	61	64	61	60	50	dB(A)
L _{wa} Outlet	71	48	60	65	61	65	63	61	51	dB(A)
L _{wa} Surrounding	52	27	28	46	45	47	45	42	30	dB(A)

Frequency	Tot	63	125	250	500	1000	2000	4000	8000	Hz
L _{wa} Inlet	75	55	66	68	70	68	66	63	58	dB(A)
L _{wa} Outlet	76	62	67	71	69	68	69	63	57	dB(A)
L _{wa} Surrounding	60	25	35	51	56	54	50	46	45	dB(A)



BDTX-EC

ROUND DUCT TYPE FANS / Backward Curved

Device Components and Material Properties
The case and fan are made of high quality galvanized sheet metal which is pressed against corrosion. All models are equipped with EC motor with integrated speed control. The terminal box and mounting legs are supplied with the product as standard. Suction and discharge nozzles are compatible with duct diameters and can be connected by clamp.

Fan Structure
Designed to work between round channels. The fan blades are aerodynamically curved and provide regular flow. The fans are composed of backward sloping and infrequently arranged fins.

Benefits
The rotation of the fan on the motor housing saves efficiency and space. It works at optimum sound levels while providing strong air suction. It can be operated in any position. If necessary, it can be mounted on the wall thanks to the mounting legs. With a more efficient motor, system efficiency is increased and lower operating costs are ensured.

Speed Control
With EC motor integrated speed control, the desired speed can be achieved.

Usage Areas
Round duct fans are used in low and medium volume ventilation requirements in duct systems where the application area is limited. It should be used with oil holding filter in oily environments.

Technical Drawing and Tables

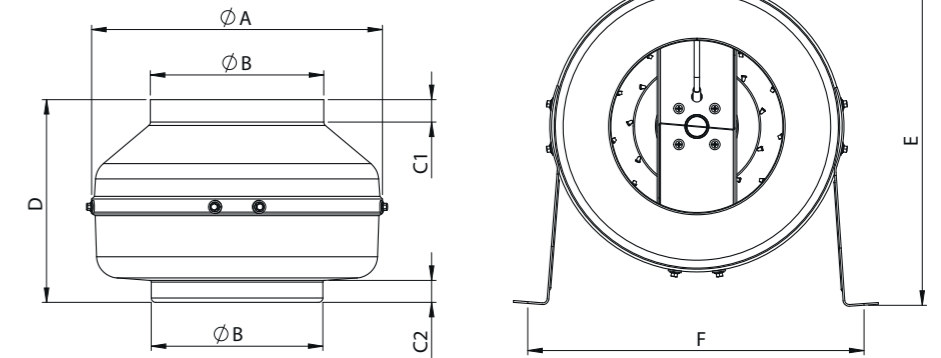

TYPE	A	B	C1	C2	D	E	F
BDTX-EC 100	245	97	20	20	197	273	268
BDTX-EC 125	245	122	20	20	188	273	268
BDTX-EC 150	272	147	23	25	192	286	295
BDTX-EC 160	272	157	23	25	192	286	295
BDTX-EC 200	330	196	30	28	230	380	352
BDTX-EC 250	330	247	30	28	227	380	352
BDTX-EC 315	400	313	30	30	285	415	422
BDTX-EC 355	400	352	30	30	378	415	422

Dimensions are in (mm)

TYPE	VOLTAGE	FREQUENCY	POWER	CURRENT	SPEED	AIR FLOW	MAX. PRESSURE	SOUND PRESSURE
	V	Hz	W	(A)	r.p.m	m ³ /h	Pa	dB(A)
BDTX-EC 100	220	50/60	90	0,7	3500	350	750	44
BDTX-EC 125	220	50/60	92	0,71	3450	500	690	43
BDTX-EC 150	220	50/60	94	0,72	3350	600	630	46
BDTX-EC 160	220	50/60	96	0,73	3345	650	650	45
BDTX-EC 200	220	50/60	130	0,87	3000	1100	600	46
BDTX-EC 250	220	50/60	135	0,85	3000	1300	700	46
BDTX-EC 315	220	50/60	150	1,2	2500	1700	750	48
BDTX-EC 355	220	50/60	350	1,5	2000	2200	500	45

Sound Level Measured from 3m distance in room condition.

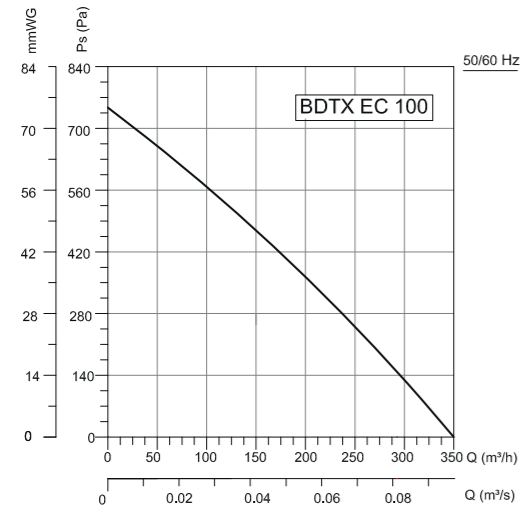

Frequency	Tot	63	125	250	500	1000	2000	4000	8000	Hz
L _{WA} Inlet	71	53	65	62	65	64	60	52	42	dB(A)
L _{WA} Outlet	68	54	64	58	62	61	58	50	40	dB(A)
L _{WA} Surrounding	51	29	17	30	47	46	45	39	27	dB(A)

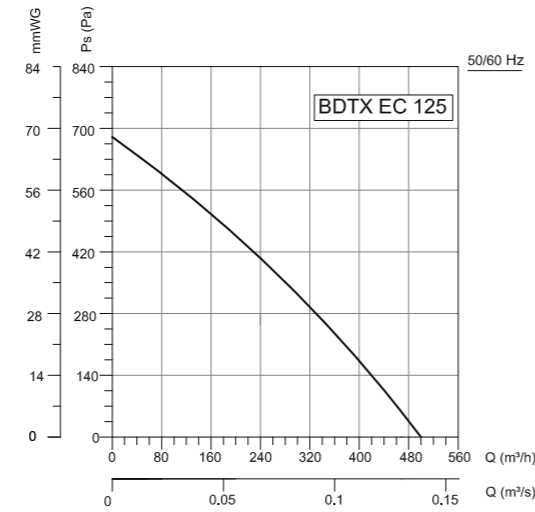

Frequency	Tot	63	125	250	500	1000	2000	4000	8000	Hz
L _{WA} Inlet	70	47	63	64	65	63	60	55	45	dB(A)
L _{WA} Outlet	68	49	62	59	62	61	58	52	43	dB(A)
L _{WA} Surrounding	50	20	20	39	45	44	43	36	30	dB(A)

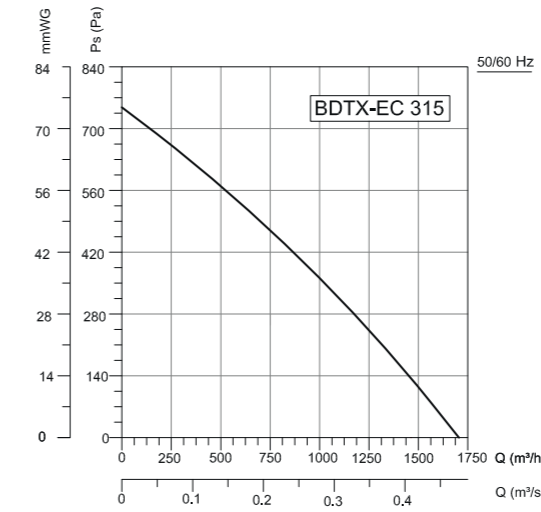

Frequency	Tot	63	125	250	500	1000	2000	4000	8000	Hz
L _{WA} Inlet	70	49	59	65	61	64	61	60	50	dB(A)
L _{WA} Outlet	71	48	60	65	61	65	63	61	51	dB(A)
L _{WA} Surrounding	52	27	28	46	45	47	45	42	30	dB(A)

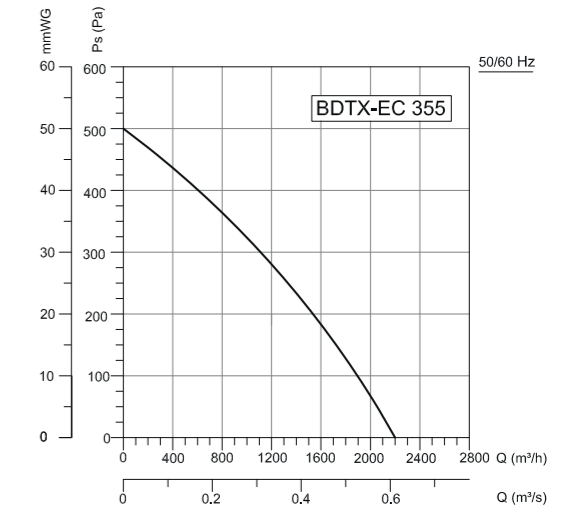

Frequency	Tot	63	125	250	500	1000	2000	4000	8000	Hz
L _{WA} Inlet	70	49	59	65	62	65	61	60	50	dB(A)
L _{WA} Outlet	71	48	60	65	61	65	63	61	51	dB(A)
L _{WA} Surrounding	54	28	29	47	47	49	45	43	30	dB(A)

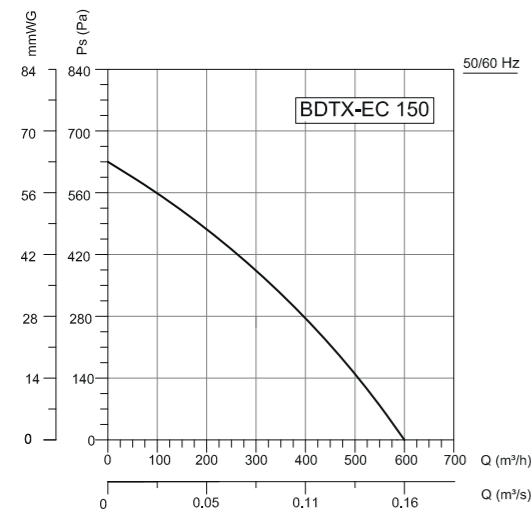

Frequency	Tot	63	125	250	500	1000	2000	4000	8000	Hz
L _{WA} Inlet	76	52	73	65	69	67	62	60	50	dB(A)
L _{WA} Outlet	74	55	71	62	68	64	62	55	50	dB(A)
L _{WA} Surrounding	53	20	35	37	50	45	46	44	32	dB(A)

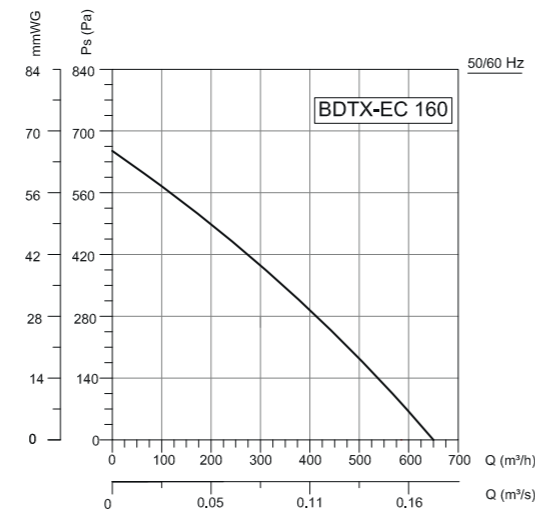

Frequency	Tot	63	125	250	500	1000	2000	4000	8000	Hz
L _{WA} Inlet	75	50	70	66	71	68	45	58	48	dB(A)
L _{WA} Outlet	76	56	74	61	69	66	62	56	48	dB(A)
L _{WA} Surrounding	52	10	32	36	48	46	45	42	28	dB(A)

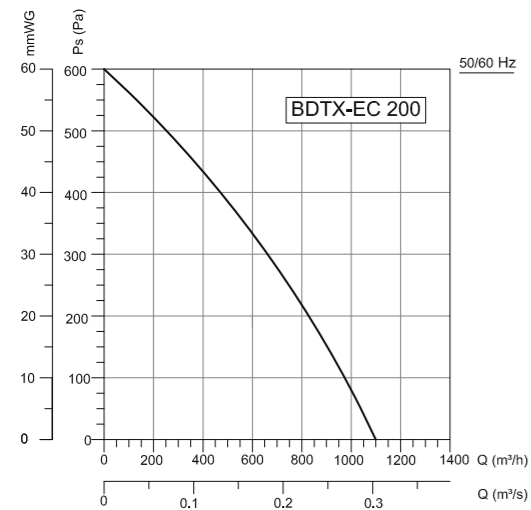

Frequency	Tot	63	125	250	500	1000	2000	4000	8000	Hz
L _{WA} Inlet	70	42	61	64	63	64	63	56	54	dB(A)
L _{WA} Outlet	71	49	59	62	65	64	64	58	53	dB(A)
L _{WA} Surrounding	53	8	25	32	45	49	47	42	38	dB(A)

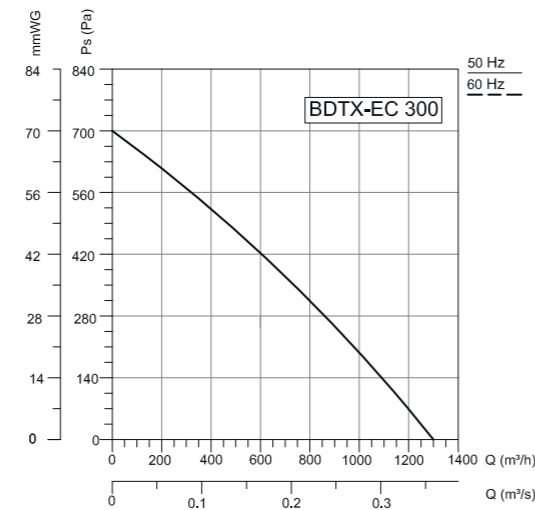

Frequency	Tot	63	125	250	500	1000	2000	4000	8000	Hz
L _{WA} Inlet	71	42	61	64	64	64	63	56	54	dB(A)
L _{WA} Outlet	72	49	60	63	66	64	66	58	53	dB(A)
L _{WA} Surrounding	54	8	35	40	47	50	47	45	40	dB(A)

Accessories





BMFX

ROUND DUCT TYPE FANS / Mixed Flow

Device Components and Material Properties

Duct type mixed flow fans, ST extension models are standard and SL extension models are silent versions. Body and fan made of plastic. In SL models, the inner wall has a special perforated design that directs the sound waves towards the sound absorbing material. BMFX 250 and 315 models are also available with electrostatic painted sheet version. Thanks to the body design, it is possible to disassemble and install the fan and motor without being disassembled.

Fan Structure

Mixed flow fans consist of a combination of working principles of axial and casing centrifugal fans. These fans draw air in and out more linearly. This makes the system more efficient and reduces motor power.

Benefits

They are highly efficient due to the mixed flow propeller. They work pretty quietly. When the fan is connected to the duct, the motor part can be easily removed and installed. They can work in double cycle. SL versions sound much quieter with sound insulation. The suction and discharge nozzles are compatible with the duct diameters and can be connected by clamp.

Speed Control

Optional control devices can be provided.
* Double speed motor * Speed control with linear voltage regulator (see BSC accessory)

Usage Areas

It is used for return air, supply air or general ventilation applications where low noise level and high efficiency are important. It should be used with oil holding filter in oily environments.

Technical Drawing and Tables

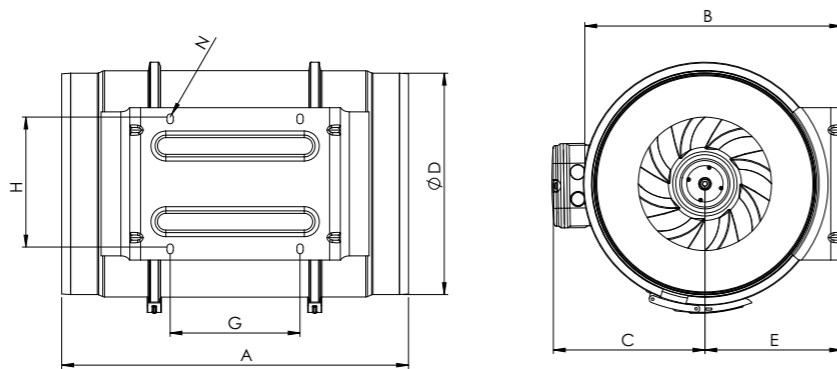

TYPE	A	B	C	D	E	G	H	N
BMFX-100	303	188	115	97	100	80	60	5,5
BMFX-125	258	188	115	123	100	80	60	5,5
BMFX-150	320	212	127	147	112	80	60	5,5
BMFX-200	302	232,5	141	197	124	100	94	5,5
BMFX-250	386	291	192	248	155	145	140	7X4
BMFX-315	450	356	224	312	188	182	178	7X4
BMFX-250-P	383	286	173	247	151	150	173	7X4
BMFX-315-P	446	357	216	312	187	181	216	7X4

Dimensions are in (mm)

TYPE	A	ØB	ØD	E	F	G	X	C	ØH
BMFX-ST100	460	204	23	81	248	333	222	93	98
BMFX-ST125	460	204	23	81	248	333	222		
BMFX-SL150	485	223	148	94	251	355	246		
BMFX-SL200	570	265	198	127	340	440	297		

Dimensions are in (mm)

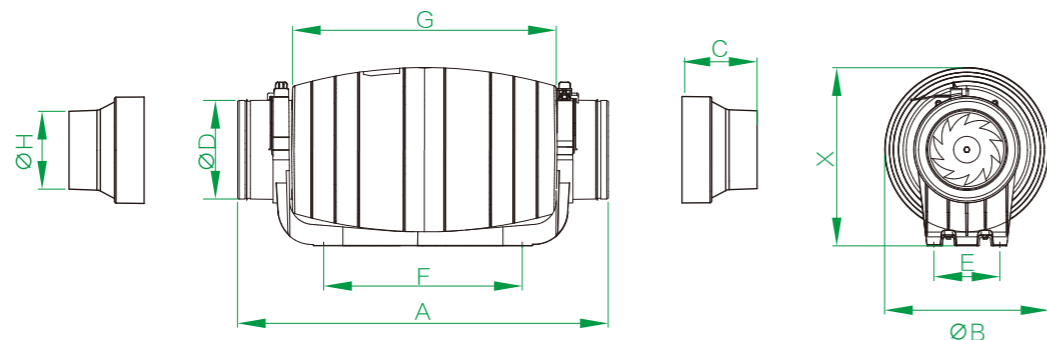

TYPE	VOLTAGE	FREQUENCY	POWER	CURRENT	CAPACITOR	SPEED	AIR FLOW	SOUND PRESSURE	INSULATION CLASS	PROTECTION CLASS	WEIGHT	SPEED
	V	Hz	W	(A)	(µF)	r.p.m	m³/h	dB(A)	Ins.cl.	IP	kg	
BMFX 100/2V	230	50/60	20	0,11	1	2200	198	31	B	44	1,8	H
			18	0,10		1850	165	26				L
BMFX 125/2V	230	50/60	27	0,14	1	2250	284	31	B	44	2	H
			23	0,12		1950	248	26				L
BMFX 150/2V	230	50/60	44	0,22	1,2	2550	530	33	B	44	2,7	H
			35	0,19		1950	410	29				L
BMFX 200/2V	230	50/60	100	0,52	3	2350	840	36	B	44	4,8	H
			90	0,48		2050	690	32				L
BMFX 250/2V	230	50/60	140	0,7	5	2500	1100	40	F	44	9,4	H
			110	0,6		2050	990	37				L
BMFX 315/2V	230	50/60	190	1,1	10	2680	2000	45	F	44	14	H
			145	0,74		2150	1500	40				L
BMFX 250-P/2V	230	50/60	225	1,2	8	2450	1405	38	B	44	7,5	H
			165	0,75		1850	1064	34				L
BMFX 315-P/2V	230	50/60	390	1,9	16	2350	2206	42	B	44	11	H
			275	1,4		1650	1750	38				L
BMFX-ST 100/2V	230	50/60	35	0,26	1	2600	177	25	B	44	3	H
			20	0,15		2100	133	23				L
BMFX-ST 125/2V	230	50/60	35	0,28	1	2600	218	31	B	44	3,5	H
			20	0,17		2100	181	26				L
BMFX-SL 150/2V	230	50/60	50	0,25	1,2	2550	530	33	B	44	4	H
			43	0,2		1850	410	26				L
BMFX-SL 200/2V	230	50/60	128	0,57	3	2450	840	35	B	44	4,8	H
			123	0,52		1950	690	29				L

Sound Level Measured from 3m distance in room condition.

Accessories

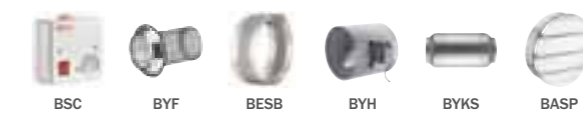

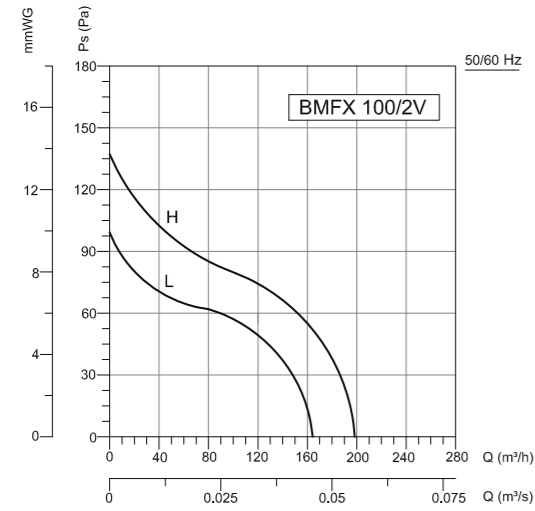

Frequency	Tot	63	125	250	500	1000	2000	4000	8000	Hz
L_{WA} Inlet	58	29	48	46	54	53	48	40	34	dB(A)
L_{WA} Surrounding	52	28	47	46	45	44	44	33	26	dB(A)

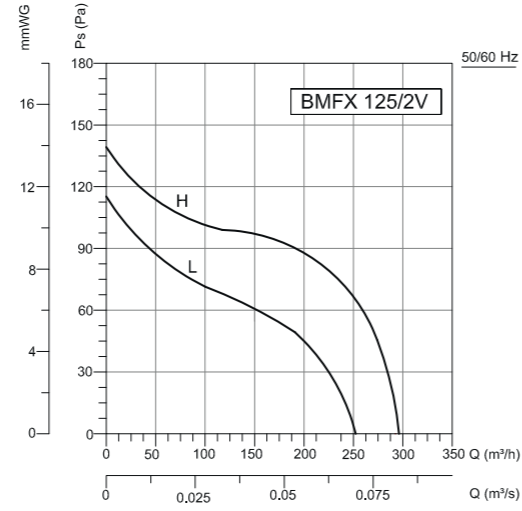

Frequency	Tot	63	125	250	500	1000	2000	4000	8000	Hz
L_{WA} Inlet	56	33	45	44	51	52	48	39	31	dB(A)
L_{WA} Surrounding	51	31	44	44	45	45	43	31	22	dB(A)

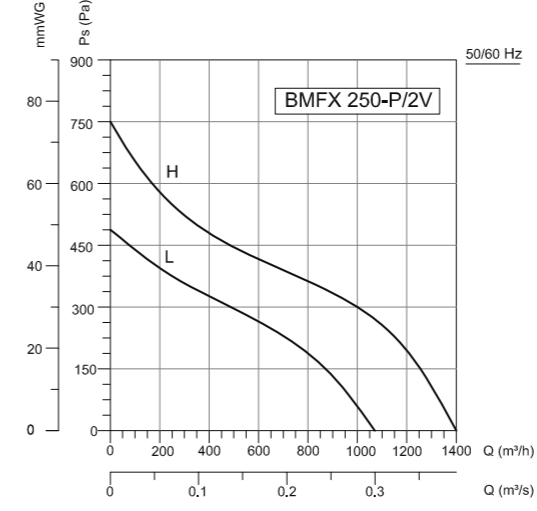

Frequency	Tot	63	125	250	500	1000	2000	4000	8000	Hz
L_{WA} Inlet	73	31	44	56	64	70	67	60	53	dB(A)
L_{WA} Surrounding	59	23	33	43	44	56	55	45	41	dB(A)

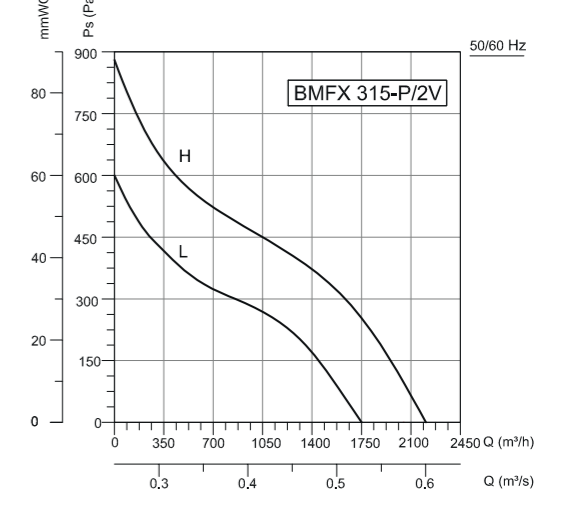

Frequency	Tot	63	125	250	500	1000	2000	4000	8000	Hz
L_{WA} Inlet	74	36	52	61	68	72	39	52	57	dB(A)
L_{WA} Surrounding	63	24	36	47	50	59	58	52	48	dB(A)

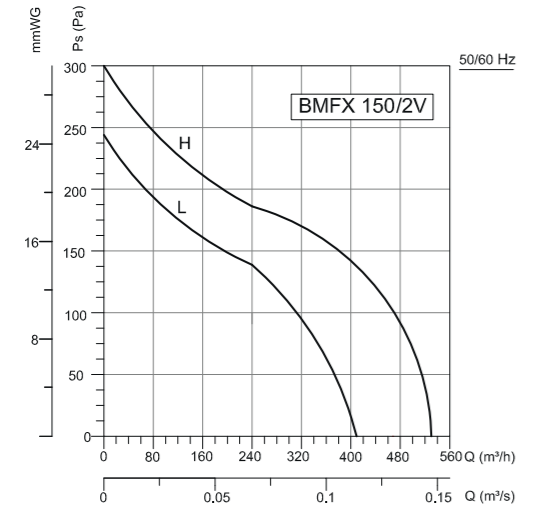

Frequency	Tot	63	125	250	500	1000	2000	4000	8000	Hz
L_{WA} Inlet	65	33	35	55	56	59	60	56	47	dB(A)
L_{WA} Surrounding	54	25	32	43	39	44	53	42	29	dB(A)

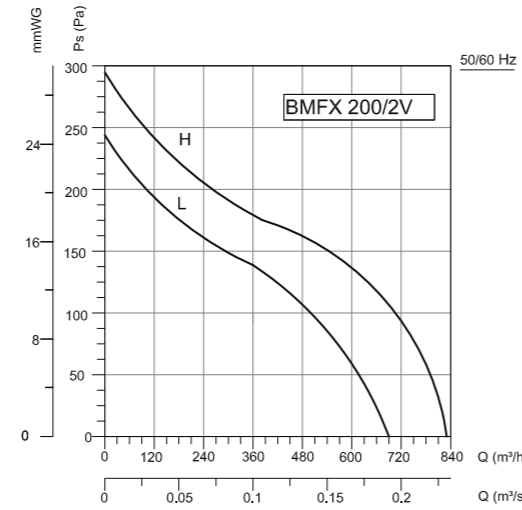

Frequency	Tot	63	125	250	500	1000	2000	4000	8000	Hz
L_{WA} Inlet	69	34	44	58	60	65	64	61	51	dB(A)
L_{WA} Surrounding	57	26	33	44	43	51	54	45	30	dB(A)

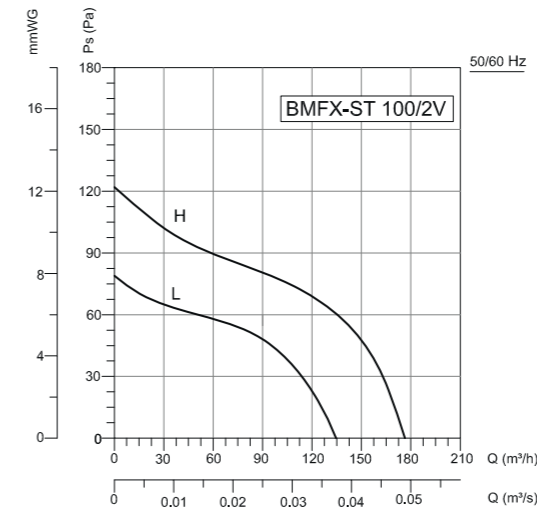

Frequency	Tot	63	125	250	500	1000	2000	4000	8000	Hz
L_{WA} Inlet	56	33	45	44	51	52	48	39	31	dB(A)
L_{WA} Surrounding	51	31	44	44	45	45	43	31	22	dB(A)

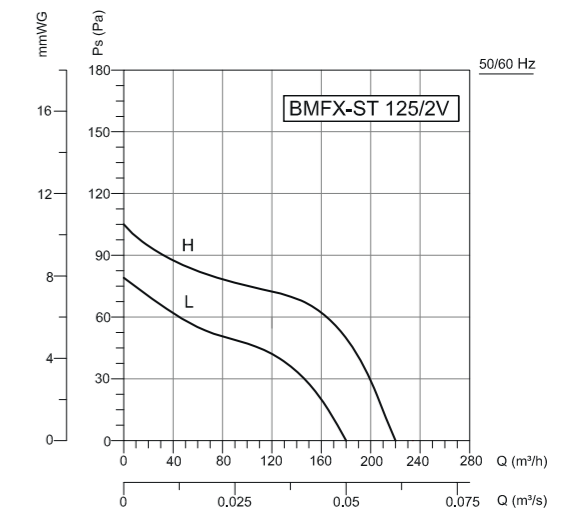

Frequency	Tot	63	125	250	500	1000	2000	4000	8000	Hz
L_{WA} Inlet	56	33	45	44	51	52	48	39	31	dB(A)
L_{WA} Surrounding	51	31	44	44	45	45	43	31	22	dB(A)

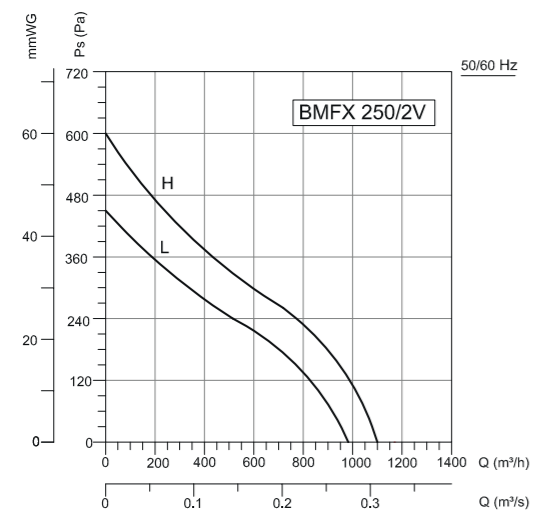

Frequency	Tot	63	125	250	500	1000	2000	4000	8000	Hz
L_{WA} Inlet	75	33	46	58	66	72	69	62	55	dB(A)
L_{WA} Surrounding	61	25	35	45	46	58	57	47	43	dB(A)

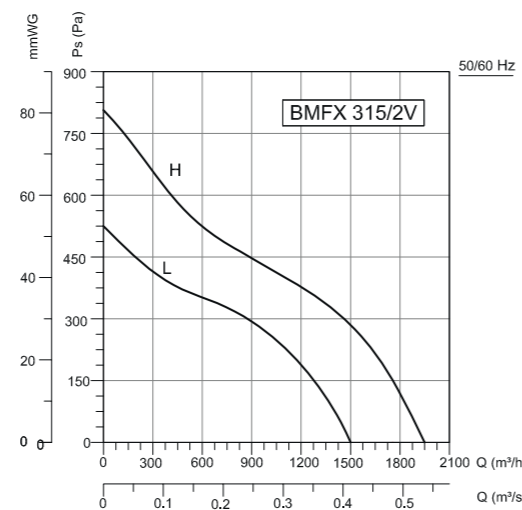

Frequency	Tot	63	125	250	500	1000	2000	4000	8000	Hz
L_{WA} Inlet	75	38	54	63	68	74	41	54	59	dB(A)
L_{WA} Surrounding	65	26	38	49	52	61	60	54	50	dB(A)

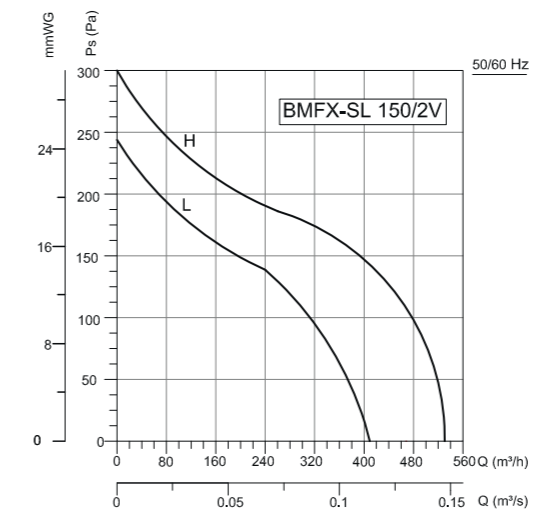

Frequency	Tot	63	125	250	500	1000	2000	4000	8000	Hz
L_{WA} Inlet	62	30	32	52	53	56	57	53	44	dB(A)
L_{WA} Surrounding	51	23	29	40	36	41	50	39	26	dB(A)

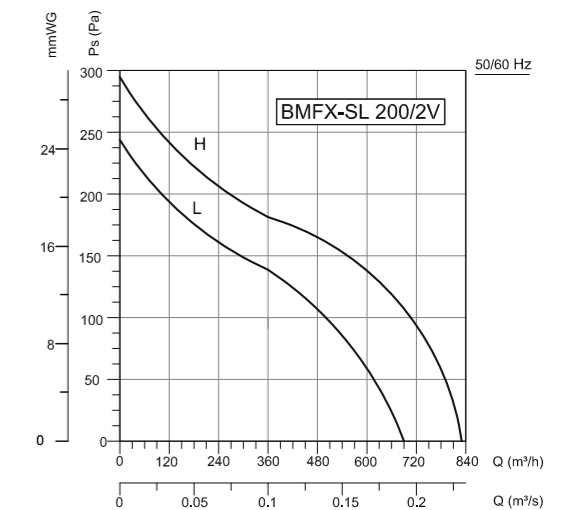

Frequency	Tot	63	125	250	500	1000	2000	4000	8000	Hz
L_{WA} Inlet	68	33	43	57	59	64	63	60	50	dB(A)
L_{WA} Surrounding	56	25	32	43	42	50	53	44	29	dB(A)



BORAX

ROUND DUCT TYPE FANS / Axial

Fan Components and Material Properties

The frame and propeller are made of electrostatic powder coated sheet metal and electrostatic powder coated from protective wire mesh. The motor and fan impeller are connected to the main body by steel carriers. It has an external rotor motor with closed structure.

Benefits

Thanks to their ideal wing angles, they achieve high air flow at minimum sound levels despite their small size. It can be easily mounted to the round duct.

Speed Control

Optional control devices can be provided.
* Linear voltage regulator speed control can be done. (see BSC accessory)

Usage Areas

BORAX axial duct fans are ideal for applications where ventilation and ventilation are required in air and industrial areas. It is also used for air circulation by machine manufacturers.

Technical Drawing and Tables

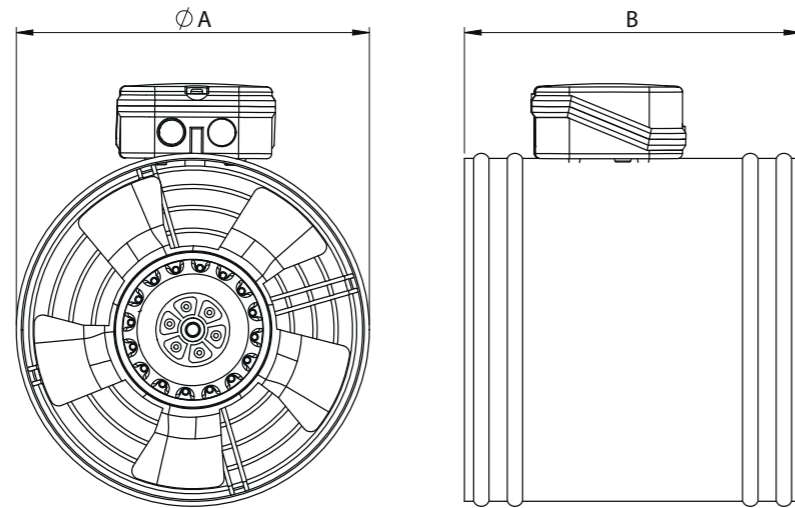

TYPE	A	B
BORAX 200-2K	200	200
BORAX 250-2K	250	250
BORAX 300-2K	300	250
BORAX 350-2K	355	250

Dimensions are in (mm)

TYPE	VOLTAGE	FREQUENCY	POWER	CURRENT	CAPACITOR	SPEED	AIR FLOW	SOUND PRESSURE	INSULATION CLASS	PROTECTION CLASS	WEIGHT
	V	Hz	W	(A)	(µF)	r.p.m	m ³ /h	dB(A)	Ins.cl.	IP	kg
BORAX 200-2K	230	50/60	63	0,28	2	2750/3200	680/790	50	B	44	2,7
BORAX 250-2K	230	50/60	100	0,5	4	2700/3100	1500/1700	55	B	44	3,6
BORAX 300-2K	230	50/60	140/190	0,6/0,85	5	2600/2800	2020/2175	57	B	44	4,6
BORAX 350-2K	230	50/60	200	0,9	5	2050	3110	62	B	44	5,6

The sound level is measured at a distance of 3 m in open field condition.

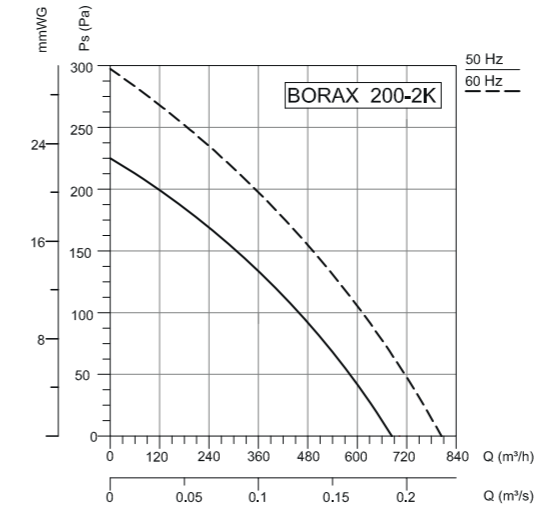

Frequency	Tot	63	125	250	500	1000	2000	4000	8000 Hz
L _{WA} Surrounding	71	38	43	64	64	65	64	58	50 dB(A)

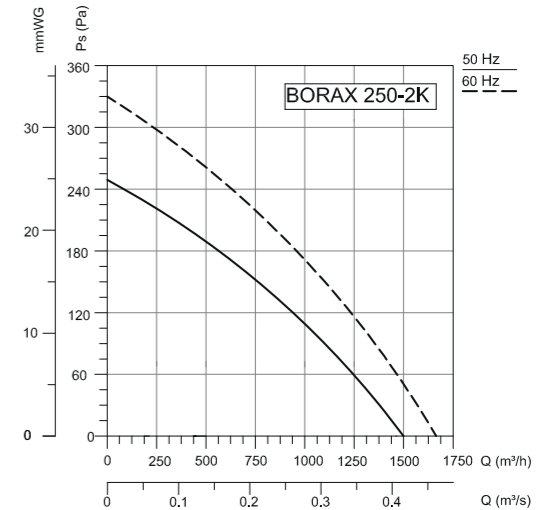

Frequency	Tot	63	125	250	500	1000	2000	4000	8000 Hz
L _{WA} Surrounding	76	44	51	66	66	70	71	67	62 dB(A)

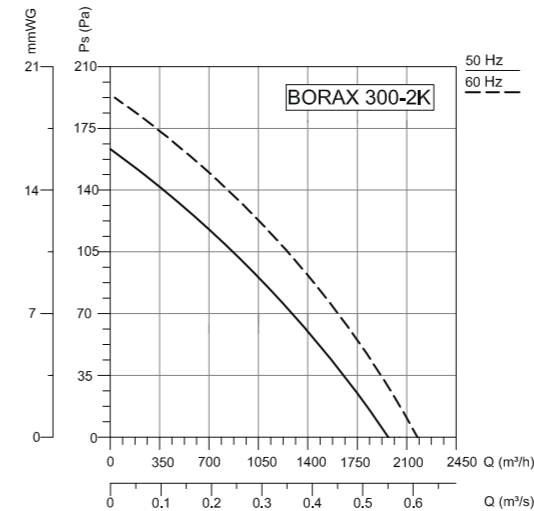

Frequency	Tot	63	125	250	500	1000	2000	4000	8000 Hz
L _{WA} Surrounding	78	46	53	68	68	72	73	69	64 dB(A)

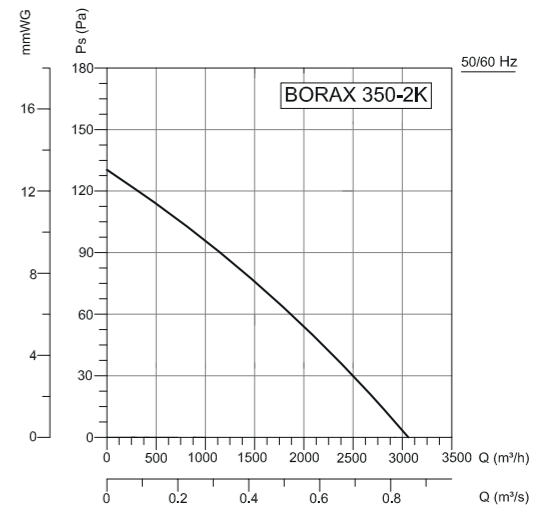

Frequency	Tot	63	125	250	500	1000	2000	4000	8000 Hz
L _{WA} Surrounding	83	48	64	68	74	80	78	73	60 dB(A)

Accessories





BPX

ROUND DUCT TYPE FANS / Plastic Housing

Fan Components and Material Properties

The case is made of plastic material. The fan is made of high quality galvanized sheet metal which is pressed against corrosion. It has an external rotor motor with closed structure. Mounting legs are supplied with the product as standard. Max.40°C air transport feature.

Fan Structure

Designed to work between round channels. The fan blades are aerodynamically curved and provide regular flow. The fans are composed of backward sloping and infrequently arranged fins.

Benefits

The rotation of the fan on the motor housing saves efficiency and space. It works at optimum

sound levels while providing strong air suction. It can be operated in any position. If necessary, it can be mounted on the wall thanks to the mounting legs. Speed can be adjusted with speed control devices.

Speed Control

Optional control devices can be provided.
* Speed control with linear voltage regulator (see BSC accessory)

Usage Areas

Round duct fans are used in low and medium volume ventilation requirements in duct systems where the application area is limited. It should be used with oil holding filter in oily environments.

Technical Drawing and Tables

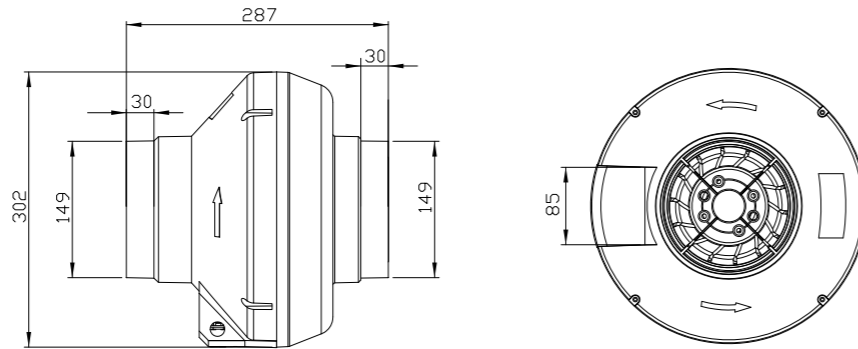

TYPE	VOLTAGE V	FREQUENCY Hz	POWER W	CURRENT (A)	CAPACITOR (µF)	SPEED r.p.m	AIR FLOW m³/h	SOUND PRESSURE dB(A)	INSULATION CLASS Ins.cl.	PROTECTION CLASS IP	WEIGHT kg
BPX 150	230	50/60	85/110	0,38/0,48	2,5	2450/2600	410/435	46	B	44	2,7

Sound Level Measured from 3m distance in room condition.

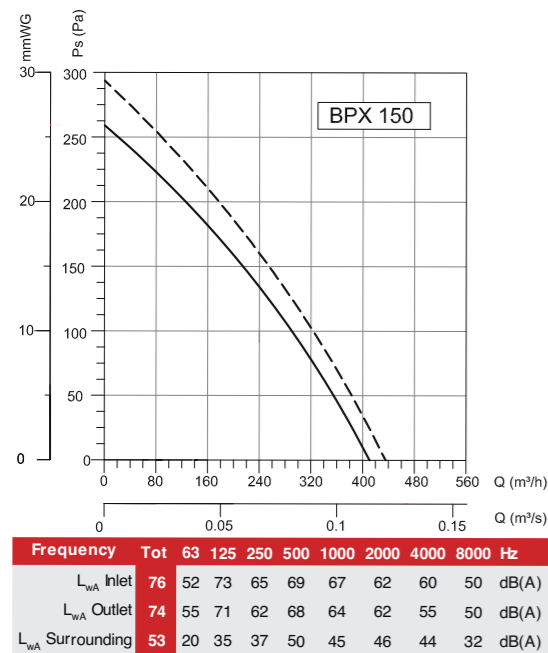

Accessories



BFTX

ROUND WALL MOUNTED FANS / Backward Curved

Fan Components and Material Properties

Square frame is electrostatic painted. The impeller is made of high quality galvanized sheet metal which is pressed against corrosion. All models have an external rotor motor with a closed structure and have air transport at max.40°C. Designed to work on the wall. It can be operated in any position. On request, the motor can be produced as thermally protected against high temperature. The terminal box is supplied with the product as standard. Suction nozzle is compatible with duct diameters and can be connected by clamp.

Fan Structure

Designed to work between round channels. The fan blades are aerodynamically curved and provide regular flow. The fans are composed of backward sloping and infrequently arranged fins.

Benefits

It can be easily mounted to the desired surface from the holes on the frame. It has a strong air flow. Speed can be adjusted with speed control devices.

Speed Control

Optional control devices can be provided.
* Linear voltage regulator speed control can be done. (see BSC accessory)

Usage Areas

Round duct fans are used in low and medium volume ventilation requirements in duct systems where the application area is limited. It should be used with oil holding filter in oily environments.

Technical Drawing and Tables

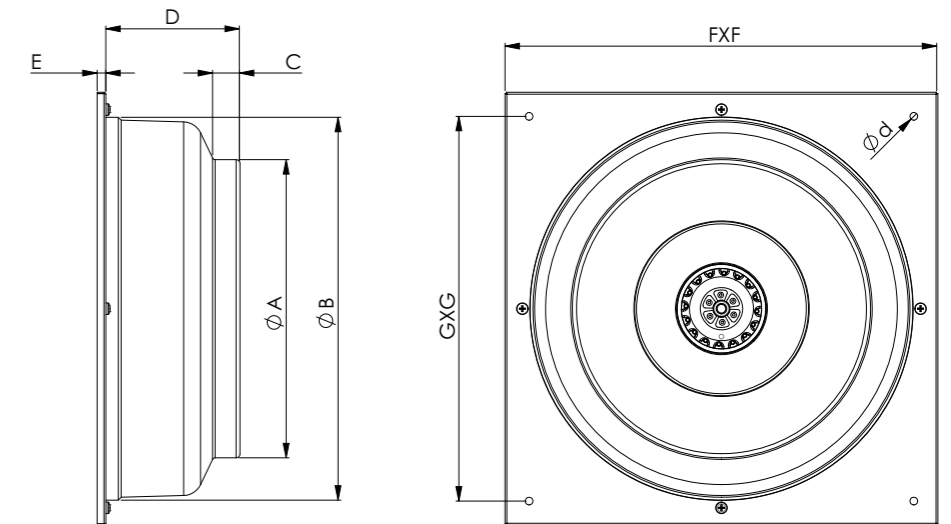

TYPE	ØA	ØB	C	D	E	F	G	d
BFTX 100	97	244	20	100	9	315	265	8
BFTX 150-B	147	270	24	105	9	400	350	8
BFTX 200-B	196	330	24	113	9	400	350	8
BFTX 250-B	246	330	24	116	9	400	350	8
BFTX 315-B	310	398	26	140	9	500	400	8

Dimensions are in (mm)

TYPE	VOLTAGE V	FREQUENCY Hz	POWER W	CURRENT (A)	CAPACITOR (µF)	SPEED r.p.m	AIR FLOW m³/h	SOUND PRESSURE dB(A)	INSULATION CLASS Ins.cl.	PROTECTION CLASS IP	WEIGHT kg
BFTX 100	230	50/60	70	0,3	2	2600/2900	240/270	44	B	44	2,7
BFTX 150-B	230	50/60	85/100	0,37/0,45	2,5	2430/2530	420/440	46	B	44	3,6
BFTX 200-B	230	50/60	110/140	0,48/0,63	4	2650/2950	870/970	48	B	44	4,8
BFTX 250-B	230	50/60	160/225	0,73/1,02	6	2550/2675	1150/1200	47	B	44	5,3
BFTX 315-B	230	50/60	200/280	0,88/0,97	7	2550/2700	1750/1890	49	B	44	6,6

Sound Level Measured from 3m distance in room condition.

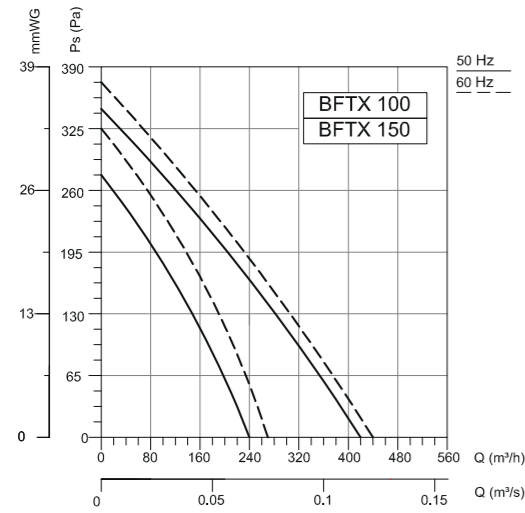

Frequency	Tot	63	125	250	500	1000	2000	4000	8000	Hz
L_{WA} Inlet	71	54	65	62	65	64	60	52	40	dB(A)
L_{WA} Outlet	68	54	64	58	62	61	58	50	37	dB(A)
L_{WA} Surrounding	51	29	17	30	48	46	44	39	27	dB(A)

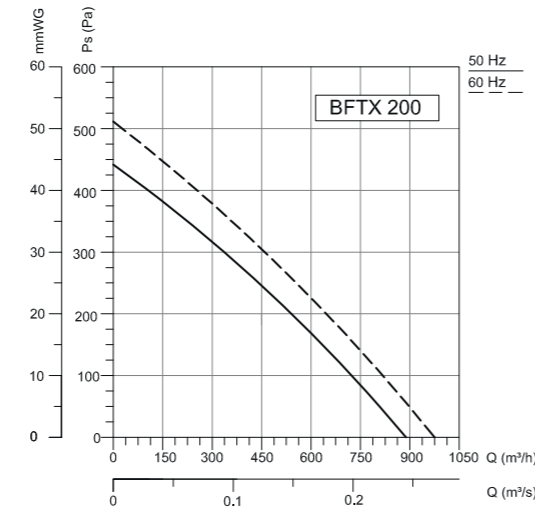

Frequency	Tot	63	125	250	500	1000	2000	4000	8000	Hz
L_{WA} Inlet	72	42	61	65	66	67	63	56	54	dB(A)
L_{WA} Outlet	71	49	59	62	65	67	64	58	53	dB(A)
L_{WA} Surrounding	54	10	25	35	45	50	49	43	39	dB(A)

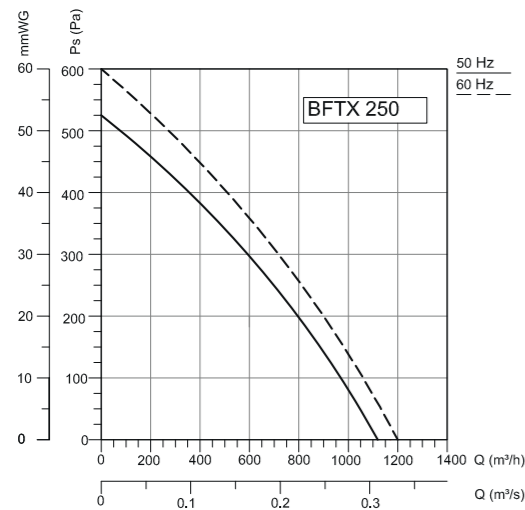

Frequency	Tot	63	125	250	500	1000	2000	4000	8000	Hz
L_{WA} Inlet	71	42	61	64	65	66	62	56	54	dB(A)
L_{WA} Outlet	70	49	58	60	64	66	63	58	53	dB(A)
L_{WA} Surrounding	53	10	25	35	44	49	48	43	39	dB(A)

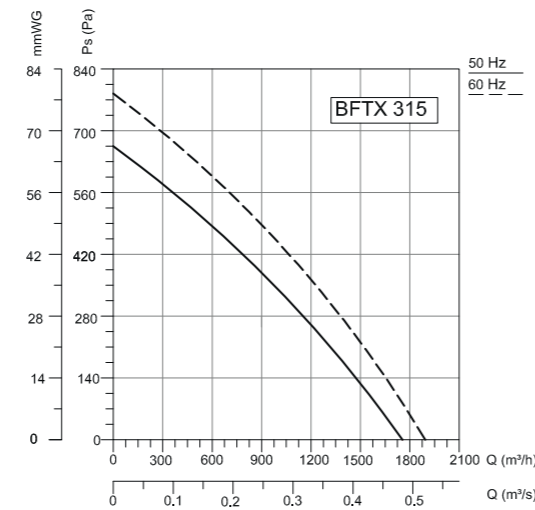

Frequency	Tot	63	125	250	500	1000	2000	4000	8000	Hz
L_{WA} Inlet	74	54	64	68	68	66	64	61	56	dB(A)
L_{WA} Outlet	75	59	65	69	67	68	68	61	55	dB(A)
L_{WA} Surrounding	56	24	37	44	51	48	50	45	46	dB(A)

Accessories



BSC BYF BESB BYH BYKS BASP

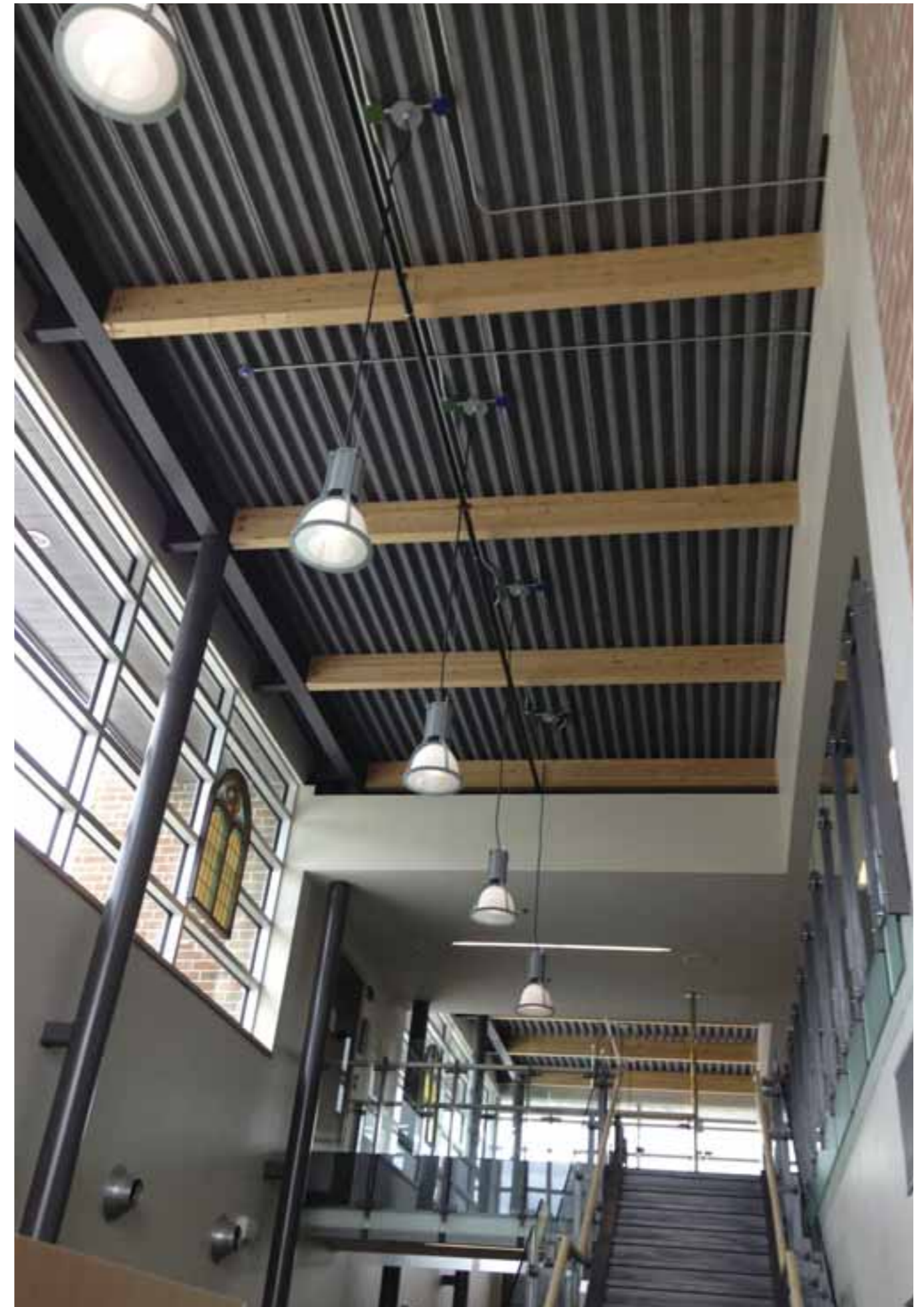



BDKF

RECTANGULAR DUCT FANS / Backward Curved

Fan Components and Material Properties

Rectangular body is manufactured from galvanized steel sheet. The models of Bdkf 30-15 / 70-40A are made of high quality galvanized steel which is resistant to corrosion. Bdkf 70-40B / 80-50 / 100-50 models are made of aluminum sheet. All models have an external rotor motor with a closed structure and have air transport at max.40°C.

Fan Structure

It is designed to work between the rectangular channel. The fan blades are aerodynamically curved and provide regular flow. The fans are composed of backward sloping and infrequently arranged fins.

Benefits

The swing-out lid allows the product to be maintained effortlessly without removing the fan. Thanks to the aerodynamic wing structure, they work quietly. Speed can be adjusted with speed control devices.

Speed Control

Optional control devices can be provided. Speed control can be done with linear voltage regulator in 1~ phase products (see BSC accessory). Speed control with frequency inverter can be done in 3~ phase products (see BSC-F accessory)

Usage Areas

It is designed to meet medium and high volume ventilation requirements in rectangular duct systems where the application area is limited.

Technical Drawing and Tables

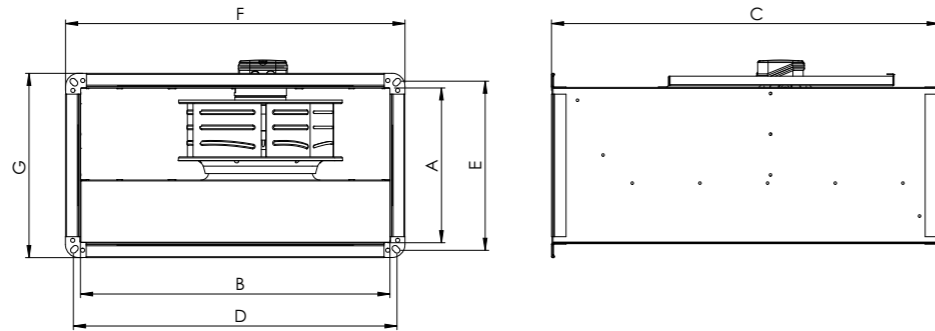

TYPE	A	B	C	D	E	F	G
BDKF 30-15	150	300	400	320	170	350	200
BDKF 40-20A	200	400	500	420	220	450	250
BDKF 40-20B	200	400	500	420	220	450	250
BDKF 50-25	250	500	565	520	270	550	300
BDKF 60-30	300	600	750	620	320	650	350
BDKF 60-35A	350	600	750	620	370	650	400
BDKF 60-35B	350	600	750	620	370	650	400
BDKF 70-40A	400	700	800	720	420	750	450
BDKF 70-40B	400	700	800	720	420	750	450
BDKF 80-50	500	800	920	820	520	850	560
BDKF 100-50	500	1000	1050	1030	530	1060	560

Dimensions are in (mm)

TYPE	VOLTAGE	FREQUENCY	POWER	CURRENT	CAPACITOR	SPEED	AIR FLOW	SOUND PRESSURE	INSULATION CLASS	PROTECTION CLASS	WEIGHT
	V	Hz	W	(A)	(µF)	r.p.m	m³/h	dB(A)	Ins.cl.	IP	kg
BDKF 30-15	230	50/60	75/95	0,37/0,47	2,5	2450	450	43	B	44	7
BDKF 40-20A	230	50/60	100/135	0,49/0,68	4	2650/2870	950/1030	48	B	44	10,5
BDKF 40-20B	230	50/60	130/180	0,64/0,9	5	2650	1150	54	B	44	11
BDKF 50-25	230	50/60	180/240	0,82/1,17	6	2600/2750	1610/1700	58	B	44	15
BDKF 60-30	230	50/60	160	0,9	6	1440/1730	1850/2220	50	F	44	29
BDKF 60-35A	230	50/60	140/160	0,86/0,82	6	1440/1725	2500/3000	53	F	44	31
BDKF 60-35B	230	50/60	200/270	1/1,4	8	1400/1680	3300/3900	58	F	44	32
BDKF 70-40A	230	50/60	310/440	1,55/2,2	10	1350/1550	4000/4600	56	F	44	44
BDKF 70-40B	230	50/60	500/775	2,5/3,7	10	1350/1450	5400/5800	58	F	44	46
BDKF 80-50M	230	50/60	880/1160	3,83/5,11	16	1250/1150	7000/6440	64	F	44	72
BDKF 100-50M	230	50	1550	7,3	25	1250	9600	66	F	44	84
BDKF 80-50	380 Δ/λ	50	960/530	2/1,1	-	1335/1050	7550/5950	64	F	44	66
BDKF 100-50	380Δ/λ	50	1400/900	2,7/1,7	-	1250/950	9600/7300	66	F	44	84

Sound Level Measured from 3m distance in room condition.

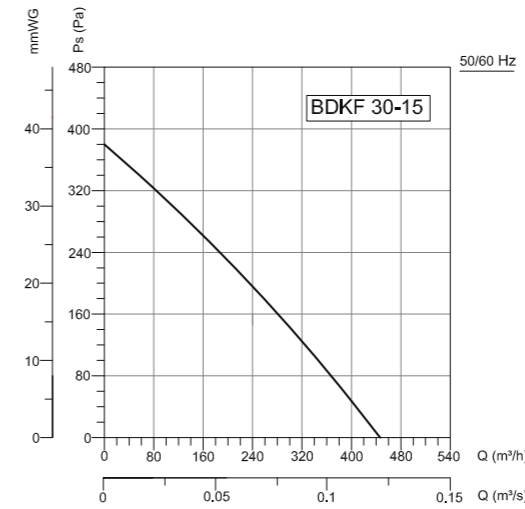

Frequency	Tot	63	125	250	500	1000	2000	4000	8000	Hz
L _{WA} Inlet	66	44	56	64	56	55	53	47	38	dB(A)
L _{WA} Outlet	69	48	53	66	63	61	58	51	43	dB(A)
L _{WA} Surrounding	50	26	33	47	44	42	41	35	27	dB(A)

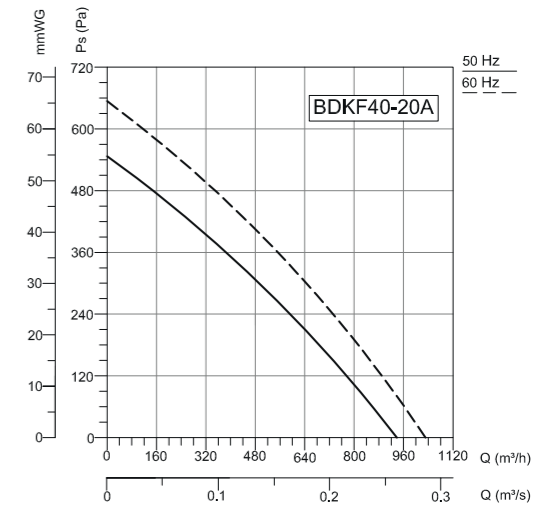

Frequency	Tot	63	125	250	500	1000	2000	4000	8000	Hz
L _{WA} Inlet	69	44	54	66	58	61	59	55	47	dB(A)
L _{WA} Outlet	72	44	53	67	64	63	66	61	58	dB(A)
L _{WA} Surrounding	55	20	34	53	45	44	44	38	35	dB(A)

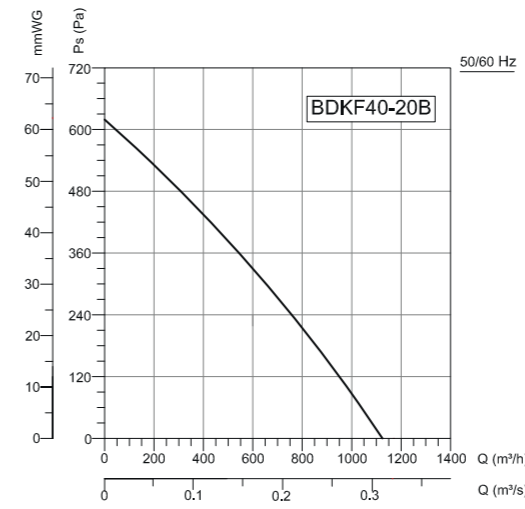

Frequency	Tot	63	125	250	500	1000	2000	4000	8000	Hz
L _{WA} Inlet	74	50	61	69	63	67	65	63	60	dB(A)
L _{WA} Outlet	78	51	61	70	69	70	73	67	69	dB(A)
L _{WA} Surrounding	61	31	35	55	54	54	55	47	45	dB(A)

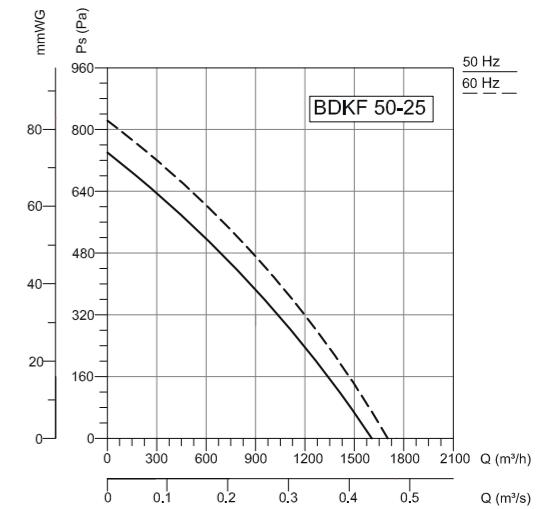

Frequency	Tot	63	125	250	500	1000	2000	4000	8000	Hz
L _{WA} Inlet	74	50	61	67	65	68	66	63	60	dB(A)
L _{WA} Outlet	78	51	61	69	71	71	73	67	70	dB(A)
L _{WA} Surrounding	65	33	40	59	57	59	58	50	47	dB(A)

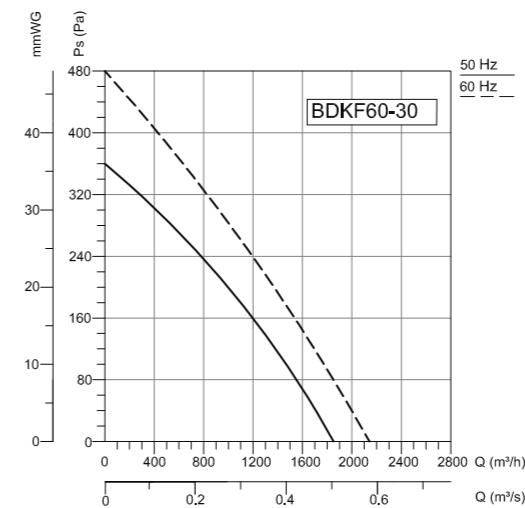

Frequency	Tot	63	125	250	500	1000	2000	4000	8000	Hz
L _{WA} Inlet	69	50	62	64	61	62	57	52	44	dB(A)
L _{WA} Outlet	72	49	60	65	68	65	63	58	46	dB(A)
L _{WA} Surrounding	57	35	47	54	52	47	44	39	32	dB(A)

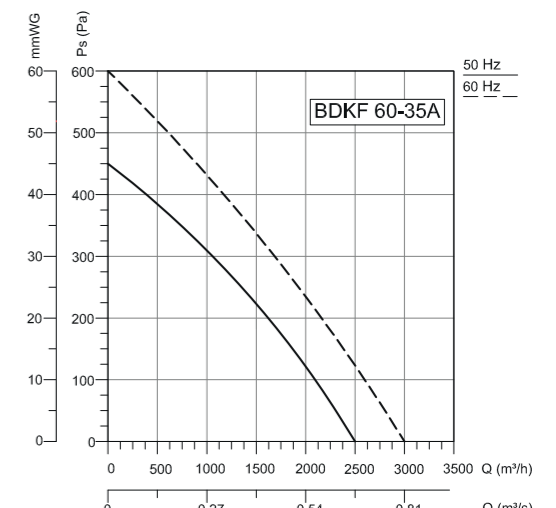

Frequency	Tot	63	125	250	500	1000	2000	4000	8000	Hz
L _{WA} Inlet	70	50	65	61	63	60	61	56	48	dB(A)
L _{WA} Outlet	76	54	72	68	69	68	67	62	54	dB(A)
L _{WA} Surrounding	60	27	57	53	50	49	48	49	37	dB(A)

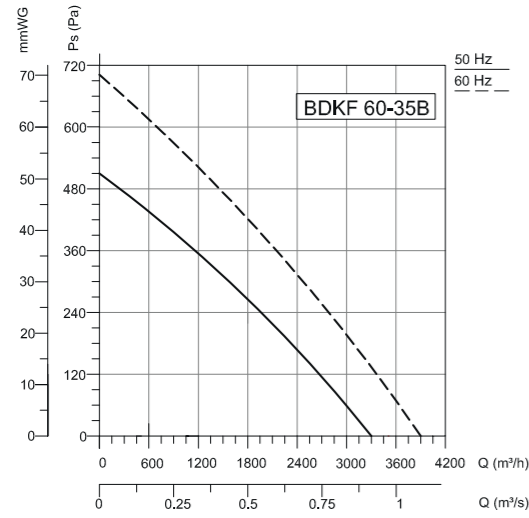

Frequency	Tot	63	125	250	500	1000	2000	4000	8000	Hz
L_{WA} Inlet	75	60	70	66	68	66	65	62	53	dB(A)
L_{WA} Outlet	80	60	71	72	74	73	71	67	58	dB(A)
L_{WA} Surrounding	65	41	63	59	54	53	48	41	35	dB(A)

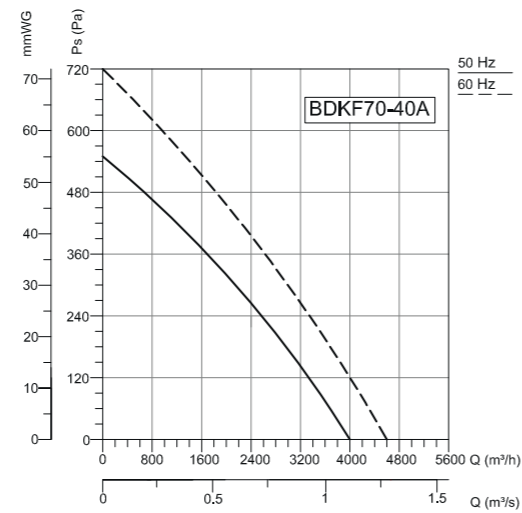

Frequency	Tot	63	125	250	500	1000	2000	4000	8000	Hz
L_{WA} Inlet	73	58	68	64	66	66	62	56	50	dB(A)
L_{WA} Outlet	77	62	68	70	71	71	69	61	55	dB(A)
L_{WA} Surrounding	63	40	60	57	52	51	46	38	35	dB(A)

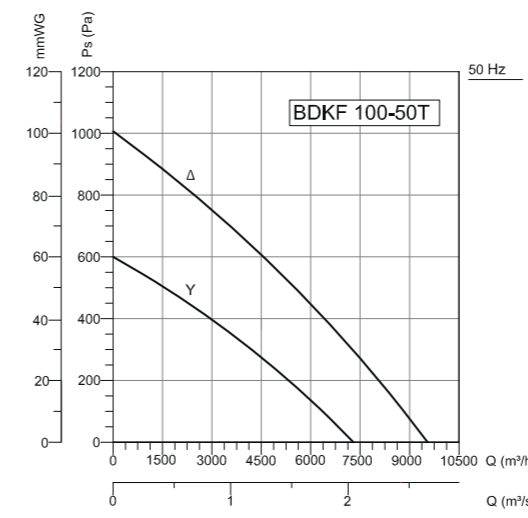

Frequency	Tot	63	125	250	500	1000	2000	4000	8000	Hz
L_{WA} Inlet	84	70	77	76	78	78	75	71	65	dB(A)
L_{WA} Outlet	89	71	80	81	82	83	80	74	65	dB(A)
L_{WA} Surrounding	72	58	69	64	62	60	56	52	50	dB(A)

Accessories

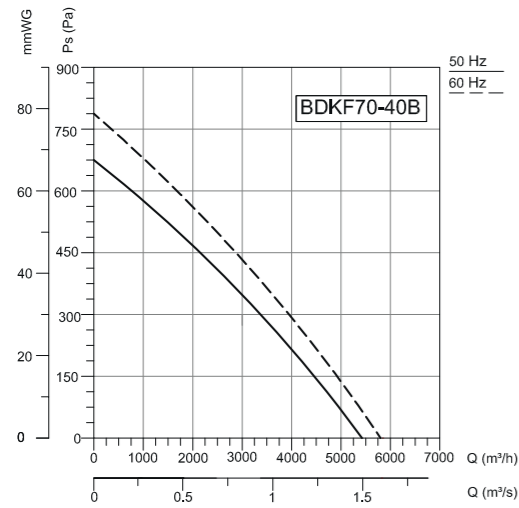

Frequency	Tot	63	125	250	500	1000	2000	4000	8000	Hz
L_{WA} Inlet	75	60	70	68	69	66	66	62	52	dB(A)
L_{WA} Outlet	79	60	71	71	73	74	71	38	55	dB(A)
L_{WA} Surrounding	65	41	62	58	56	56	49	42	36	dB(A)

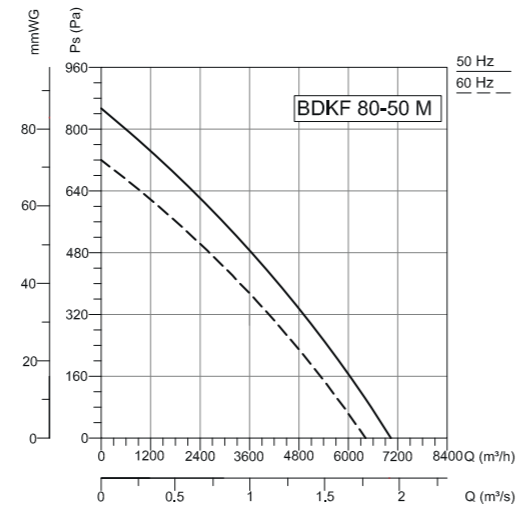

Frequency	Tot	63	125	250	500	1000	2000	4000	8000	Hz
L_{WA} Inlet	79	61	72	71	73	71	71	66	58	dB(A)
L_{WA} Outlet	84	66	75	76	77	79	75	70	61	dB(A)
L_{WA} Surrounding	71	45	68	64	61	61	60	54	43	dB(A)

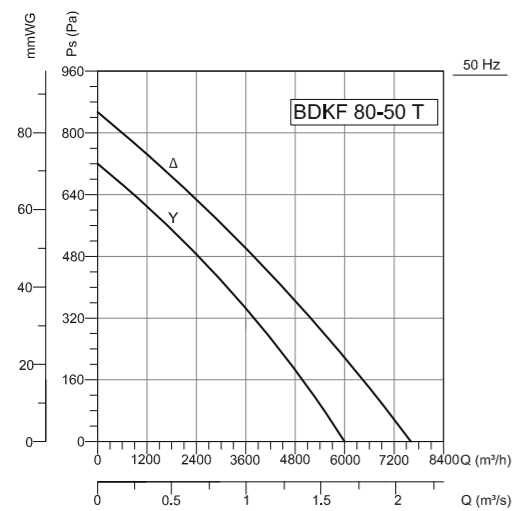

Frequency	Tot	63	125	250	500	1000	2000	4000	8000	Hz
L_{WA} Inlet	79	61	72	71	73	71	71	66	58	dB(A)
L_{WA} Outlet	84	66	75	76	77	79	75	70	61	dB(A)
L_{WA} Surrounding	71	45	68	64	61	61	60	54	43	dB(A)

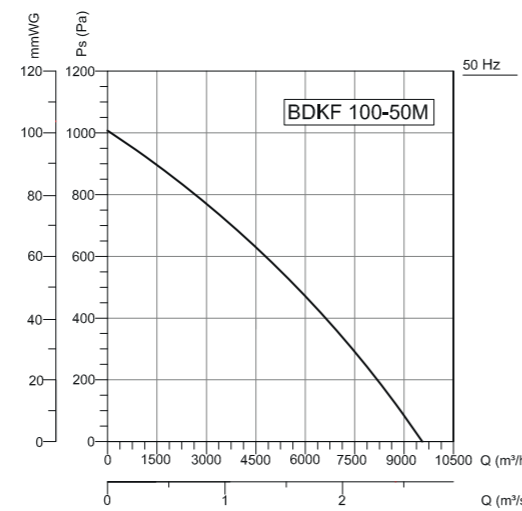

Frequency	Tot	63	125	250	500	1000	2000	4000	8000	Hz
L_{WA} Inlet	84	70	77	76	78	78	75	71	65	dB(A)
L_{WA} Outlet	89	71	80	81	82	83	80	74	65	dB(A)
L_{WA} Surrounding	72	58	69	64	62	60	56	52	50	dB(A)





BDKF-EC

RECTANGULAR DUCT FANS / Backward Curved

Fan Components and Material Properties

Rectangular body is manufactured from galvanized steel sheet. The models of Bdkf 30-15 / 70-40A are made of high quality galvanized steel which is resistant to corrosion. Bdkf 70-40B / 80-50 / 100-50 models are made of aluminum sheet. All models are equipped with EC motor with integrated speed control.

Fan Structure

It is designed to work between the rectangular channel. The fan blades are aerodynamically curved and provide regular flow. The fans are composed of backward sloping and infrequently arranged fins.

Benefits

The swing-out lid allows the product to be maintained effortlessly without removing the fan. Thanks to the aerodynamic wing structure, they work quietly. With a more efficient motor, system efficiency is increased and lower operating costs are ensured.

Speed Control

With EC motor integrated speed control, the desired speed can be achieved.

Usage Areas

It is designed to meet medium and high volume ventilation requirements in rectangular duct systems where the application area is limited.

Technical Drawing and Tables

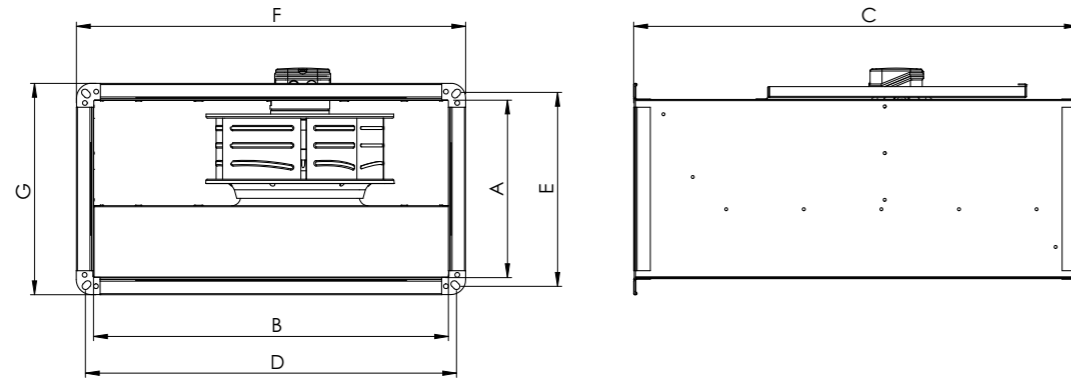

TYPE	A	B	C	D	E	F	G
BDKF-EC 30-15	150	300	400	320	170	350	200
BDKF-EC 40-20	200	400	500	420	220	450	250
BDKF-EC 50-25	250	500	565	520	270	550	300
BDKF-EC 60-30	300	600	750	620	320	650	350
BDKF-EC 60-35	350	600	750	620	370	650	400
BDKF-EC 70-40	400	700	800	720	420	750	450
BDKF-EC 80-50	500	800	920	820	520	850	560
BDKF-EC 100-50	500	1000	1050	1030	530	1060	560

Dimensions are in (mm)

TYPE	VOLTAGE	FREQUENCY	POWER	CURRENT	SPEED	AIR FLOW	MAX. PRESSURE	SOUND PRESSURE
	V	Hz	W	(A)	r.p.m	m ³ /h	Pa	dB(A)
BDKF-EC 30-15	220	50/60	98	0,74	3200	650	750	43
BDKF-EC 40-20	220	50/60	150	0,98	2945	1300	750	48
BDKF-EC 50-25	220	50/60	140	1,1	2400	1600	750	58
BDKF-EC 60-30	220	50/60	355	1,56	2050	2150	550	50
BDKF-EC 60-35	220	50/60	400	2,2	1900	3550	850	53
BDKF-EC 70-40	380	50/60	1000	1,5	1500	6500	650	56
BDKF-EC 80-50	380	50/60	870	1,46	1100	7000	450	64
BDKF-EC 100-50	380	50/60	770	1,3	850	8500	320	66

Sound Level Measured from 3m distance in room condition.

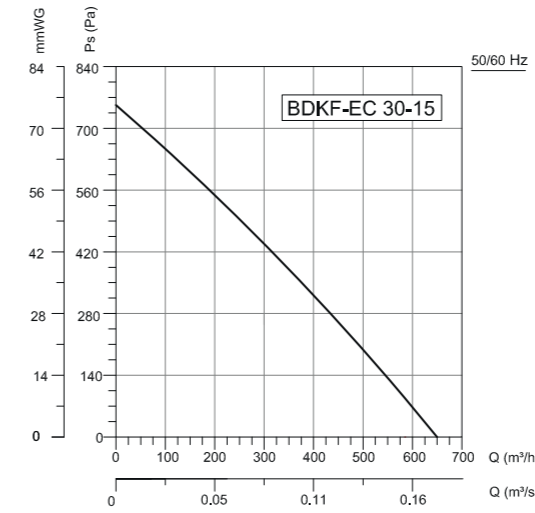

Frequency	Tot	63	125	250	500	1000	2000	4000	8000 Hz
L _{wa} Inlet	66	44	56	64	56	55	53	47	38 dB(A)
L _{wa} Outlet	69	48	53	66	63	61	58	51	43 dB(A)
L _{wa} Surrounding	50	26	33	47	44	42	41	35	27 dB(A)

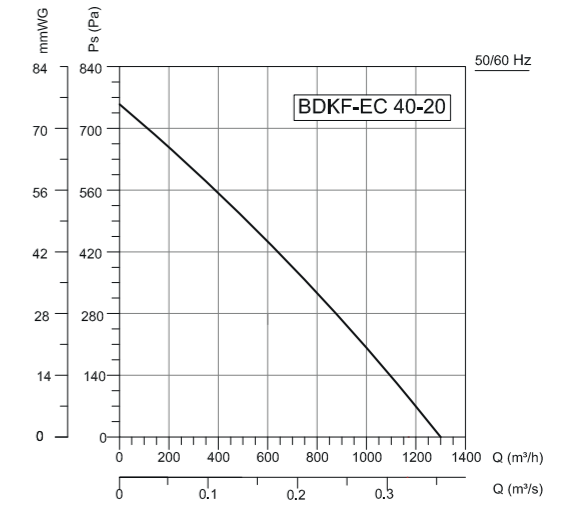

Frequency	Tot	63	125	250	500	1000	2000	4000	8000 Hz
L _{wa} Inlet	69	44	54	66	58	61	59	55	47 dB(A)
L _{wa} Outlet	72	44	53	67	64	63	66	61	58 dB(A)
L _{wa} Surrounding	55	20	34	53	45	44	44	38	35 dB(A)

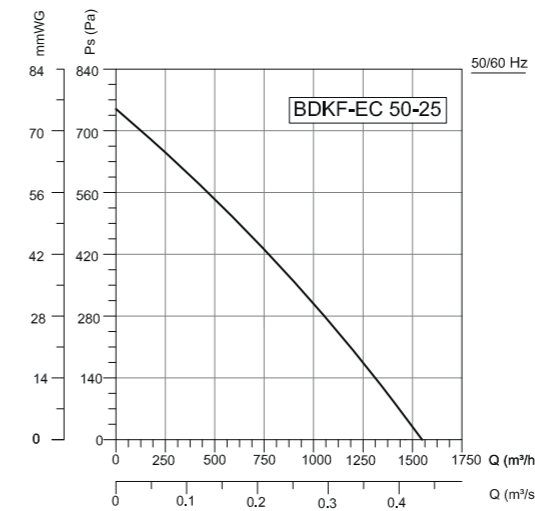

Frequency	Tot	63	125	250	500	1000	2000	4000	8000 Hz
L _{wa} Inlet	74	50	61	67	65	68	66	63	60 dB(A)
L _{wa} Outlet	78	51	61	69	71	71	73	67	70 dB(A)
L _{wa} Surrounding	65	33	40	59	57	59	58	50	47 dB(A)

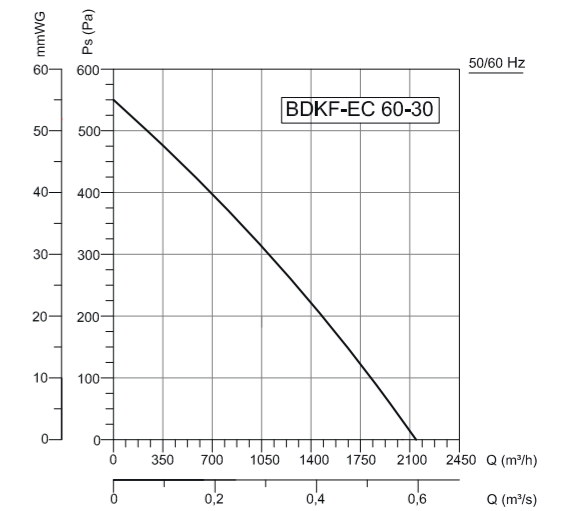

Frequency	Tot	63	125	250	500	1000	2000	4000	8000 Hz
L _{wa} Inlet	69	50	62	64	61	62	57	52	44 dB(A)
L _{wa} Outlet	72	49	60	65	68	65	63	58	46 dB(A)
L _{wa} Surrounding	57	35	47	54	52	47	44	39	32 dB(A)

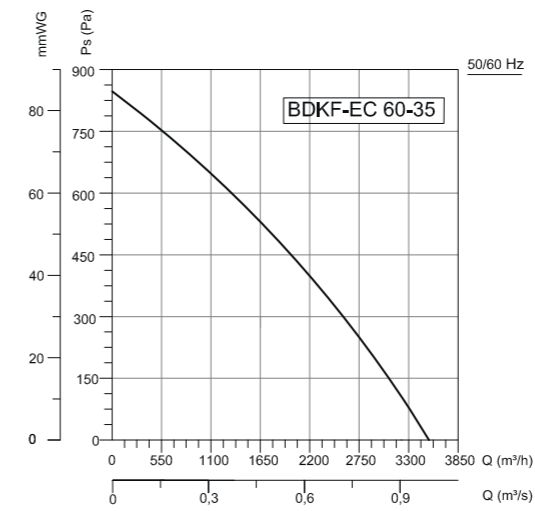

Frequency	Tot	63	125	250	500	1000	2000	4000	8000 Hz
L _{wa} Inlet	70	50	65	61	63	60	61	56	48 dB(A)
L _{wa} Outlet	76	54	72	68	69	68	67	62	54 dB(A)
L _{wa} Surrounding	60	27	57	53	50	49	48	49	37 dB(A)

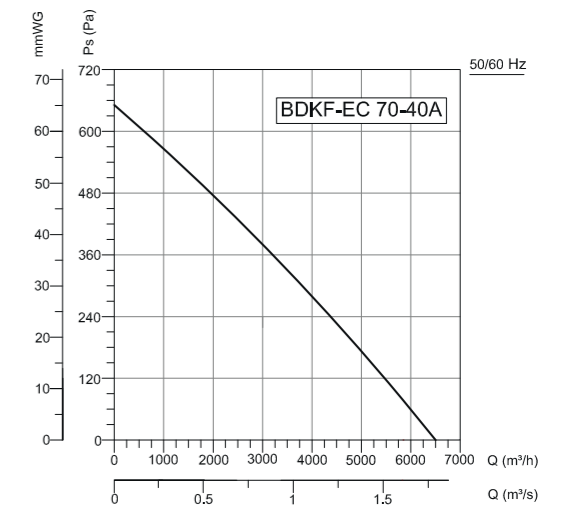

Frequency	Tot	63	125	250	500	1000	2000	4000	8000 Hz
L _{wa} Inlet	75	60	70	68	69	66	66	62	52 dB(A)
L _{wa} Outlet	79	60	71	71	73	74	71	38	55 dB(A)
L _{wa} Surrounding	65	41	62	58	56	56	49	42	36 dB(A)

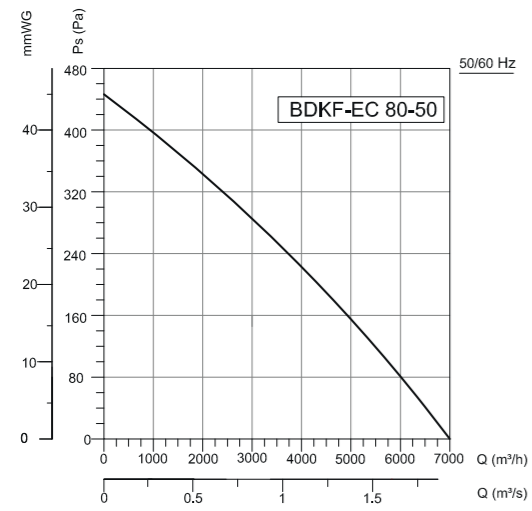

Frequency	Tot	63	125	250	500	1000	2000	4000	8000	Hz
L _{wa} Inlet	79	61	72	71	73	71	71	66	58	dB(A)
L _{wa} Outlet	84	66	75	76	77	79	75	70	61	dB(A)
L _{wa} Surrounding	71	45	68	64	61	61	60	54	43	dB(A)

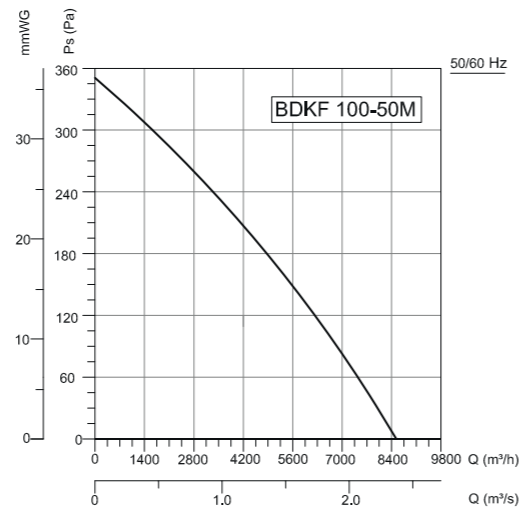

Frequency	Tot	63	125	250	500	1000	2000	4000	8000	Hz
L _{wa} Inlet	84	70	77	76	78	78	75	71	65	dB(A)
L _{wa} Outlet	89	71	80	81	82	83	80	74	65	dB(A)
L _{wa} Surrounding	72	58	69	64	62	60	56	52	50	dB(A)

Accessories

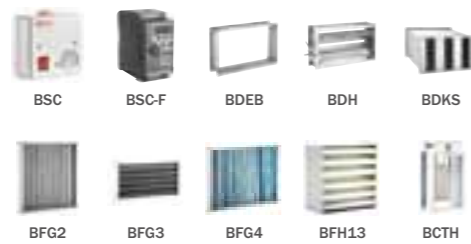

BKKF
SQUARE DUCT FANS / Backward Curved

Fan Components and Material Properties

The double-walled body with heat and sound insulation is manufactured from galvanized sheet metal. The fan of the Bkkf 400 is made of high quality galvanized steel which is resistant to corrosion. The fans of the Bkkf 450-500-560 models are made of aluminum sheet. All models have an external rotor motor with closed structure. The device is capable of handling air at max.40°C.

Fan Structure

The fan blades are aerodynamically curved and provide regular flow. The fans are composed of backward sloping and infrequently arranged fins.

Benefits

The swing-out lid allows the product to be maintained effortlessly without removing the fan.

They work quietly thanks to isolation. Thanks to the removable panels, the air can be easily steered in the desired way. Speed can be adjusted with speed control devices.

Speed Control

Optional control devices can be provided. Speed control can be done with linear voltage regulator in 1 ~ phase products (see BSC accessory). Speed control with frequency inverter can be done in 3 ~ phase products (see BSC-F accessory)

Usage Areas

It is designed to meet medium and high volume ventilation requirements in channel systems where the application area is limited.

Technical Drawing and Tables

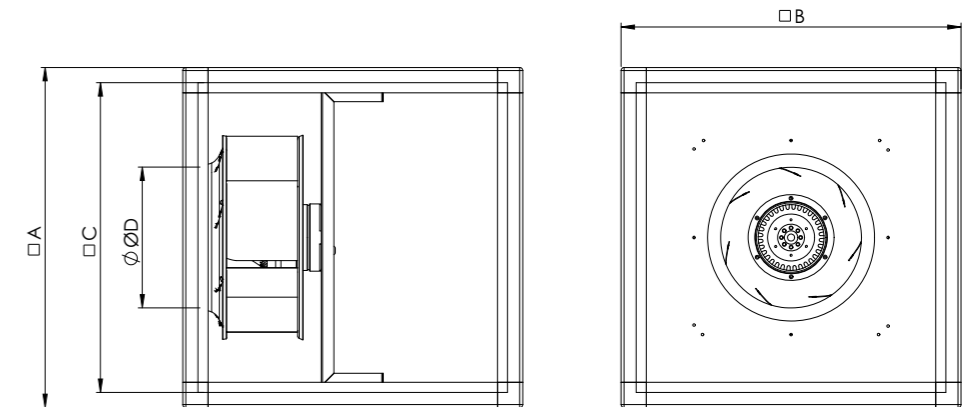

TYPE	A	B	C	D
BKKF 400 M	670	670	610	270
BKKF 450 M	670	670	610	283
BKKF 500 T	670	670	610	344
BKKF 560 T	800	800	740	382

Dimensions are in (mm)

TYPE	VOLTAGE	FREQUENCY	POWER	CURRENT	CAPACITOR	SPEED	AIR FLOW	SOUND PRESSURE	INSULATION CLASS	PROTECTION CLASS	WEIGHT
	V	Hz	W	(A)	(µF)	r.p.m	m³/h	dB(A)	Ins.cl.	IP	kg
BKKF 400 M	230	50/60	310/460	1,4/2	10	1400/1600	4200/4800	45	F	44	36
BKKF 450 M	230	50/60	480/745	2,5/3,5	10	1400/1550	5500/6000	48	F	44	40
BKKF 500 T	380 Δ/λ	50	960/530	2/1,1	-	1335/1050	7800/6100	52	F	44	51
BKKF 560 T	380 Δ/λ	50	1400/900	2,7/1,7	-	1250/950	9800/7450	55	F	44	65

Sound Level Measured from 3m distance in room condition.

BSKF

RECTANGULAR DUCT FANS / Forward Curved



Fan Components and Material Properties

Rectangular body is manufactured from galvanized steel sheet. All models have an external rotor motor with a closed structure and have air transport at max.40°C.

Fan Structure

The fan blades are produced in an aerodynamic structure to provide forward flow and forward flow. It is designed to work between the rectangular channel.

Benefits

The swing-out lid allows the product to be maintained effortlessly without removing the fan. Thanks to the aerodynamic wing structure, they work quietly. Speed can be adjusted with speed control devices.

Speed Control

Optional control devices can be provided. 1 ~ Phase products can be controlled with linear voltage regulator (see BSC accessory). 3 ~ phase products can be controlled by frequency inverter (see BSC-F accessory).

Usage Areas

It is designed to meet medium and high volume ventilation requirements in rectangular duct systems where the application area is limited. It is recommended to use barber with filter in dirty environments.

Technical Drawing and Tables

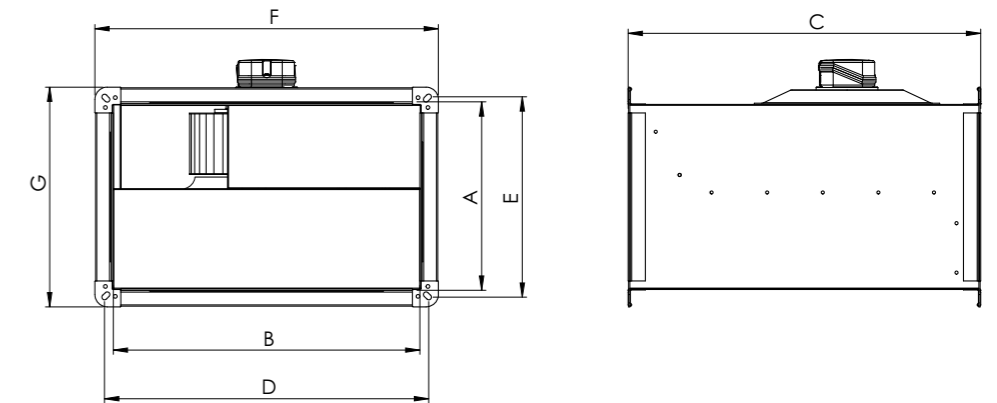

TYPE	A	B	C	D	E	F	G
BSKF 40-20	198	398	502	420	220	440	240
BSKF 50-25	248	498	532	520	270	540	290
BSKF 50-30	298	498	562	520	320	540	340
BSKF 60-30	298	598	642	620	320	640	340
BSKF 60-35	348	600	720	620	370	650	390

Dimensions are in (mm)

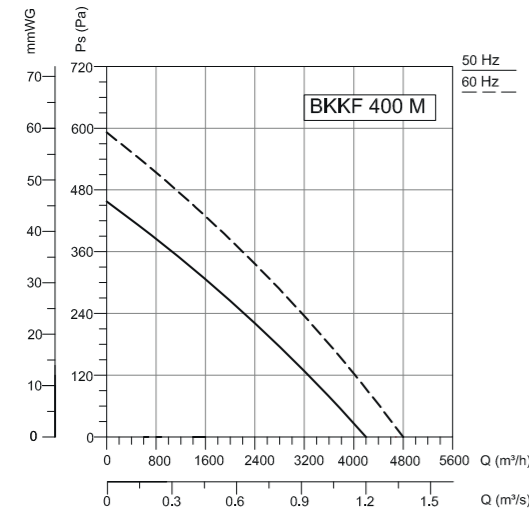

Frequency	Tot	63	125	250	500	1000	2000	4000	8000	Hz
L _{wa} Inlet	67	37	55	53	59	63	61	54	49	dB(A)
L _{wa} Outlet	68	38	56	55	60	64	62	56	51	dB(A)
L _{wa} Surrounding	52	18	43	44	43	48	46	38	33	dB(A)

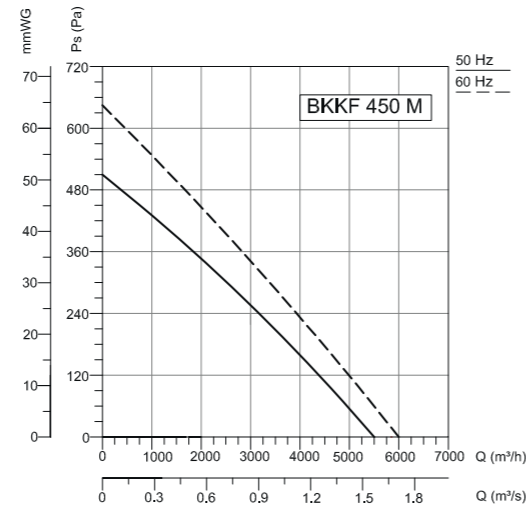

Frequency	Tot	63	125	250	500	1000	2000	4000	8000	Hz
L _{wa} Inlet	72	42	57	58	64	66	67	61	54	dB(A)
L _{wa} Outlet	74	46	58	59	65	70	69	63	55	dB(A)
L _{wa} Surrounding	55	22	46	47	46	51	49	41	38	dB(A)

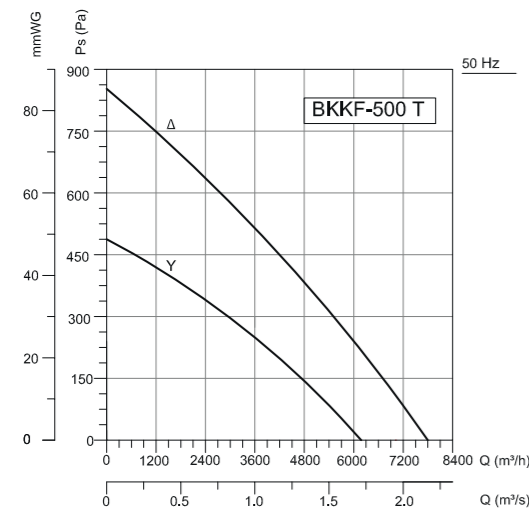

Frequency	Tot	63	125	250	500	1000	2000	4000	8000	Hz
L _{wa} Inlet	79	48	64	64	69	74	75	71	62	dB(A)
L _{wa} Outlet	81	49	65	66	71	76	76	73	64	dB(A)
L _{wa} Surrounding	59	24	50	50	51	54	50	45	39	dB(A)

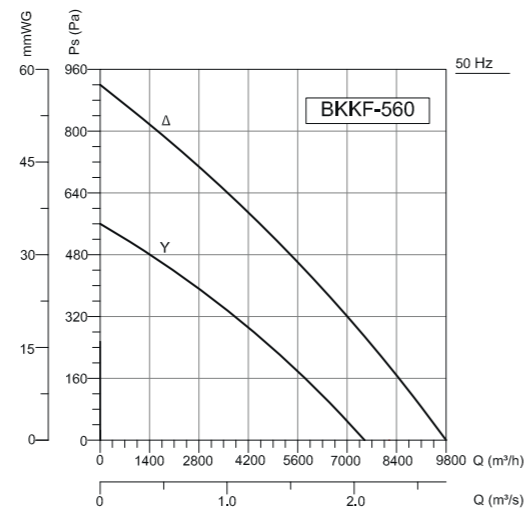

Frequency	Tot	63	125	250	500	1000	2000	4000	8000	Hz
L _{wa} Inlet	78	65	68	71	73	72	69	65	58	dB(A)
L _{wa} Outlet	80	67	68	74	75	74	70	66	60	dB(A)
L _{wa} Surrounding	63	50	52	57	58	56	54	50	40	dB(A)

Accessories



TYPE	VOLTAGE	FREQUENCY	POWER	CURRENT	CAPACITOR	SPEED	AIR FLOW	SOUND PRESSURE	INSULATION CLASS	PROTECTION CLASS	WEIGHT
	V	Hz	W	(A)	(µF)	r.p.m	m ³ /h	dB(A)	Ins.cl.	IP	kg
BSKF 40-20	230	50/60	230/315	1,15/1,41	6	1400/1590	990	53	F	44	14
BSKF 50-25	230	50/60	465/635	2/2,7	10	1300	1750	55	F	44	19
BSKF 50-30	230	50	675	3	10	1300	2100	58	F	44	23
BSKF 60-30	380 Δ/λ	50	1335/720	2,43/1,32	-	1200/850	2950/2090	60	F	44	36
BSKF 60-35	380 Δ/λ	50	1755/880	3,2/1,6	-	1200/800	4250/2830	62	F	44	44

Sound Level Measured from 3m distance in room condition.

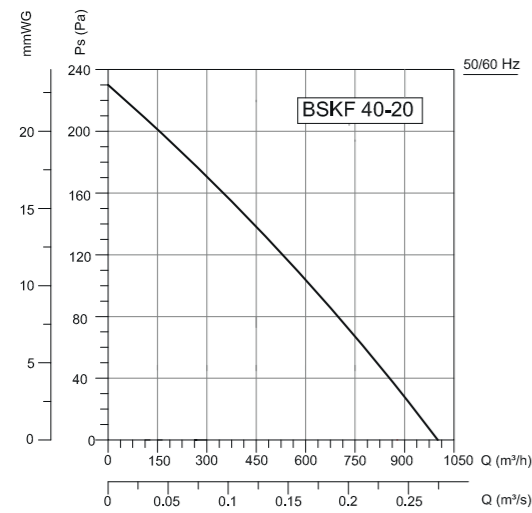

Frequency	Tot	63	125	250	500	1000	2000	4000	8000	Hz
L_{WA} Inlet	71	58	68	65	60	58	56	54	49	dB(A)
L_{WA} Outlet	73	54	65	67	65	66	62	60	55	dB(A)
L_{WA} Surrounding	60	35	47	57	53	52	45	42	38	dB(A)

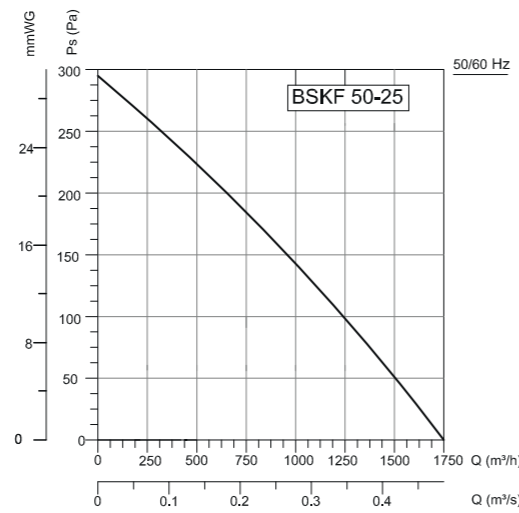

Frequency	Tot	63	125	250	500	1000	2000	4000	8000	Hz
L_{WA} Inlet	73	61	66	65	64	65	63	62	57	dB(A)
L_{WA} Outlet	76	57	63	65	67	71	70	68	66	dB(A)
L_{WA} Surrounding	62	39	50	53	54	56	52	50	55	dB(A)

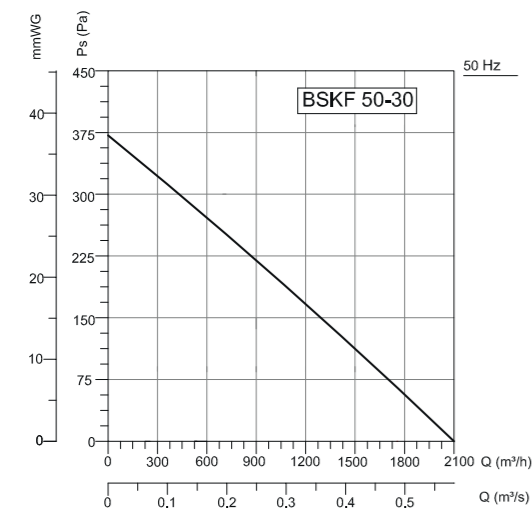

Frequency	Tot	63	125	250	500	1000	2000	4000	8000	Hz
L_{WA} Inlet	76	66	71	65	64	67	67	66	62	dB(A)
L_{WA} Outlet	79	62	68	67	70	74	72	71	66	dB(A)
L_{WA} Surrounding	65	45	55	60	56	59	55	50	49	dB(A)

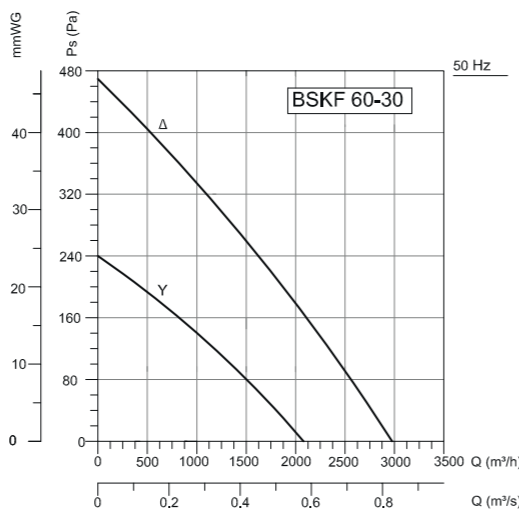

Frequency	Tot	63	125	250	500	1000	2000	4000	8000	Hz
L_{WA} Inlet	78	71	71	67	66	71	71	68	63	dB(A)
L_{WA} Outlet	80	59	70	68	73	75	72	73	68	dB(A)
L_{WA} Surrounding	67	39	60	61	60	58	55	53	49	dB(A)

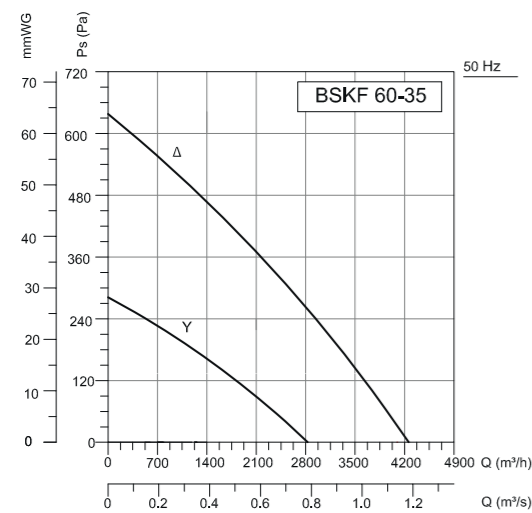

Frequency	Tot	63	125	250	500	1000	2000	4000	8000	Hz
L_{WA} Inlet	80	72	75	67	68	73	72	69	65	dB(A)
L_{WA} Outlet	83	65	72	71	75	79	76	74	70	dB(A)
L_{WA} Surrounding	69	53	63	64	60	61	56	53	48	dB(A)

Accessories



BDKF-R

RECTANGULAR DUCT FANS / Backward Curved

Fan Components and Material Properties

Rectangular body is manufactured from galvanized steel sheet. The fans of the Bdkf-r 315-355-400 are made of high quality galvanized steel which is resistant to corrosion. The fans of the Bdkf-r 450-500-560 models are made of aluminum sheet. All models use an asynchronous motor and the motor is out of airflow. The device is capable of carrying air at max. 120°C.

Fan Structure

It is designed to work between the rectangular channel. The fan blades are aerodynamically curved and provide regular flow. The fans are composed of backward sloping and infrequently arranged fins.

Benefits

Since the motor is out of airflow, it is resistant to high temperature. The swing-out lid allows the product to be maintained effortlessly without removing the fan. Thanks to the aerodynamic wing structure, they work quietly. Speed can be adjusted with speed control devices.

Speed Control

Optional control devices can be provided. Speed control with frequency inverter can be done in 3 ~ phase products (see BSC-F accessory)

Usage Areas

It is designed to meet medium and high volume ventilation requirements in rectangular duct systems where the application area is limited. It is able to carry air at higher temperatures due to the motor being out of airflow.

Technical Drawing and Tables

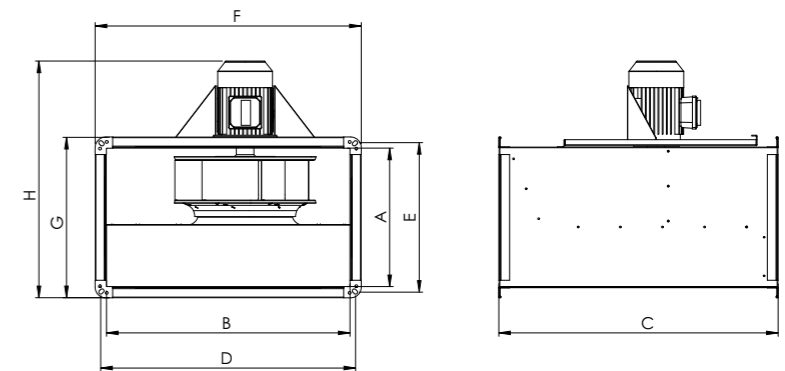

TYPE	A	B	C	D	E	F	G	H
BDKF-R 315	350	600	750	620	370	650	400	550
BDKF-R 355	350	600	750	620	370	650	400	550
BDKF-R 400	400	700	800	720	420	750	450	630
BDKF-R 450	400	700	800	720	420	750	450	630
BDKF-R 500	500	800	920	820	520	850	560	780
BDKF-R 560	500	1000	1050	1030	530	1060	560	780

Dimensions are in (mm)

TYPE	VOLTAGE	FREQUENCY	POWER	CURRENT	CAPACITOR	SPEED	AIR FLOW	SOUND PRESSURE	INSULATION CLASS	PROTECTION CLASS	WEIGHT
	V	Hz	kW	(A)	(µF)	r.p.m	m³/h	dB(A)	Ins.cl.	IP	kg
BDKF-R 315 M	230	50	0,25	2,1	10	1380	2000	53	F	55	35
BDKF-R 355 M	230	50	0,25	2,1	10	1380	3000	58	F	55	36
BDKF-R 400 M	230	50	0,37	3,4	15	1390	4100	56	F	55	49
BDKF-R 450 M	230	50	0,55	4,5	20	1395	5500	58	F	55	52
BDKF-R 500 M	230	50	1,1	7,5	35	1410	8100	64	F	55	74
BDKF-R 560 M	230	50	2,2	14,2	50	1420	10500	66	F	55	91
BDKF-R 315 T	380	50	0,25	0,87	-	1380	2000	53	F	55	35
BDKF-R 355 T	380	50	0,25	0,87	-	1380	3000	58	F	55	36
BDKF-R 400 T	380	50	0,37	1,2	-	1390	4100	56	F	55	49
BDKF-R 450 T	380	50	0,55	1,6	-	1395	5500	58	F	55	52
BDKF-R 500 T	380	50	1,1	2,6	-	1410	8100	64	F	55	74
BDKF-R 560 T	380	50	2,2	4,9	-	1420	10500	66	F	55	91

Sound Level Measured from 3m distance in room condition.

Accessories



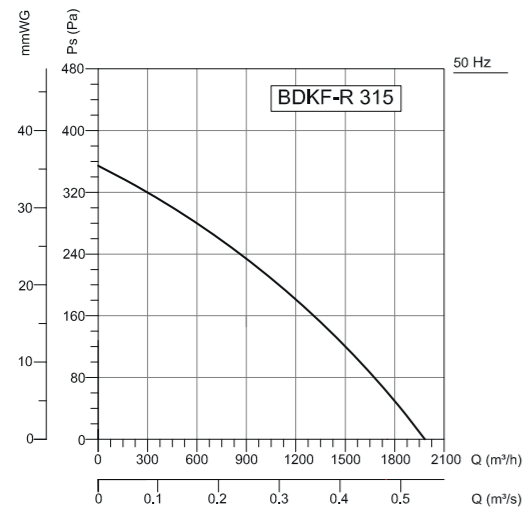

Frequency	Tot	63	125	250	500	1000	2000	4000	8000	Hz
L_{wA} Inlet	70	50	65	61	63	60	61	56	48	dB(A)
L_{wA} Outlet	76	54	72	68	69	68	67	62	54	dB(A)
L_{wA} Surrounding	60	27	57	53	50	49	48	49	37	dB(A)

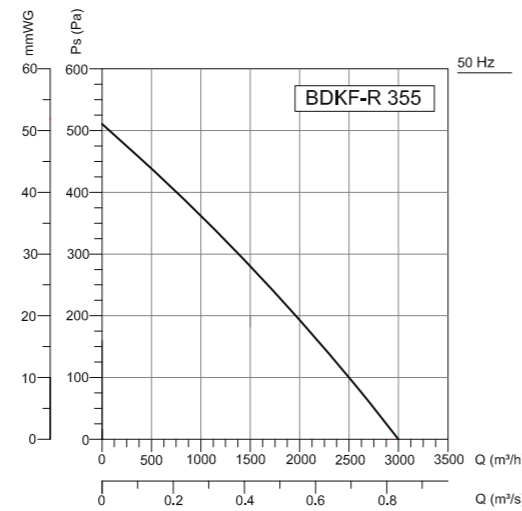

Frequency	Tot	63	125	250	500	1000	2000	4000	8000	Hz
L_{wA} Inlet	74	50	61	67	65	68	66	63	60	dB(A)
L_{wA} Outlet	78	51	61	69	71	71	73	67	70	dB(A)
L_{wA} Surrounding	65	33	40	59	57	59	58	50	47	dB(A)

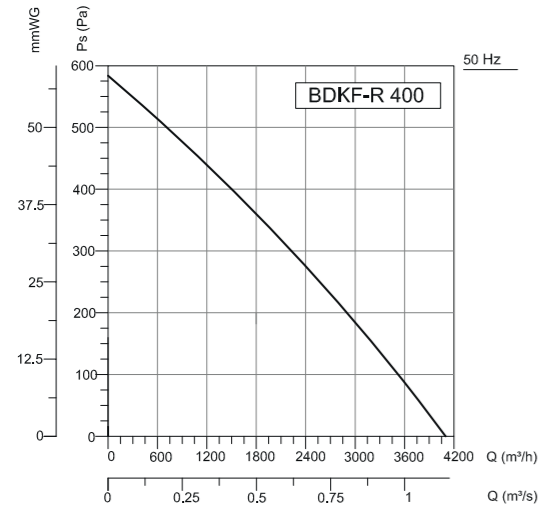

Frequency	Tot	63	125	250	500	1000	2000	4000	8000	Hz
L_{wA} Inlet	73	58	68	64	66	66	62	56	50	dB(A)
L_{wA} Outlet	77	62	68	70	71	71	69	61	55	dB(A)
L_{wA} Surrounding	63	40	60	57	52	51	46	38	35	dB(A)

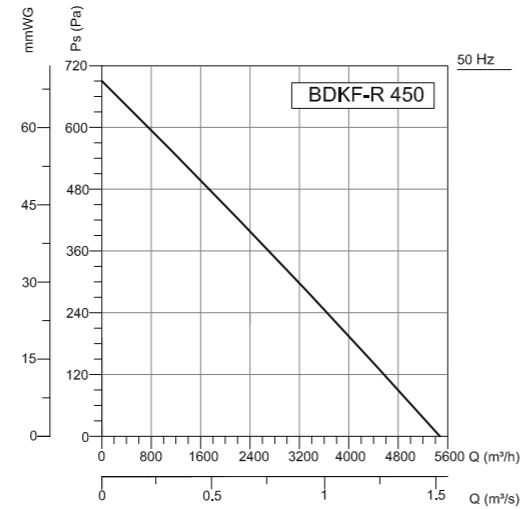

Frequency	Tot	63	125	250	500	1000	2000	4000	8000	Hz
L_{wA} Inlet	70	50	65	61	63	60	61	56	48	dB(A)
L_{wA} Outlet	76	54	72	68	69	68	67	62	54	dB(A)
L_{wA} Surrounding	60	27	57	53	50	49	48	49	37	dB(A)

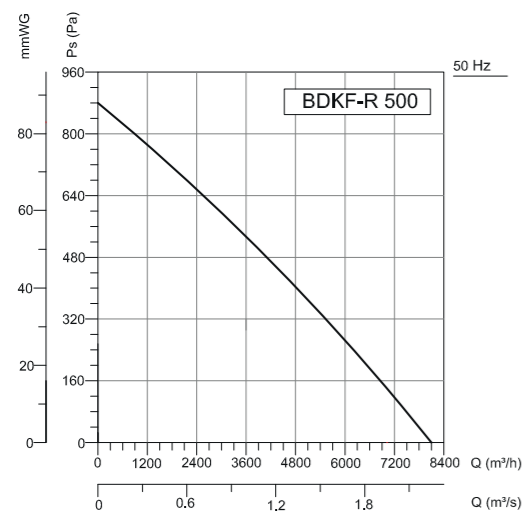

Frequency	Tot	63	125	250	500	1000	2000	4000	8000	Hz
L_{wA} Inlet	79	61	72	71	73	71	71	66	58	dB(A)
L_{wA} Outlet	84	66	75	76	77	79	75	70	61	dB(A)
L_{wA} Surrounding	71	45	68	64	61	61	60	54	43	dB(A)

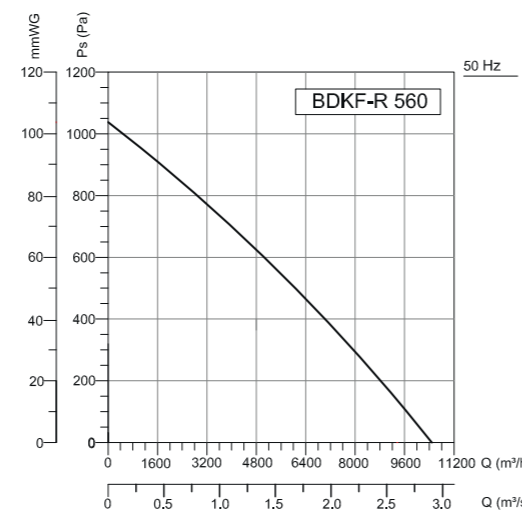

Frequency	Tot	63	125	250	500	1000	2000	4000	8000	Hz
L_{wA} Inlet	84	70	77	76	78	78	75	71	65	dB(A)
L_{wA} Outlet	89	71	80	81	82	83	80	74	65	dB(A)
L_{wA} Surrounding	73	58	70	65	63	61	58	54	50	dB(A)



BSKF-R

RECTANGULAR DUCT FANS / Forward Curved

Fan Components and Material Properties
The rectangular body and the impellers of the fans are made of high quality galvanized steel which is resistant to corrosion. The BSKF-R is equipped with an asynchronous motor outside the air flow. The device is capable of carrying air at max.120°C.

Fan Structure
The fan blades are produced in an aerodynamic structure to provide forward flow and forward flow. It is designed to work between the rectangular channel.

Benefits
Since the motor is out of airflow, it is resistant to high temperature. The swing-out lid allows the product to be maintained effortlessly without removing

the fan. Thanks to the aerodynamic wing structure, they work quietly. Speed can be adjusted with speed control devices.

Speed Control
Optional control devices can be provided. 3 ~ phase products with frequency inverter speed control can be done. (see BSC-F accessory)

Usage Areas
It is designed to meet medium and high volume ventilation requirements in rectangular duct systems where the application area is limited. It is able to carry air at higher temperatures due to the motor being out of airflow. It is recommended to use bar-bar with filter in dirty environments.

Technical Drawing and Tables

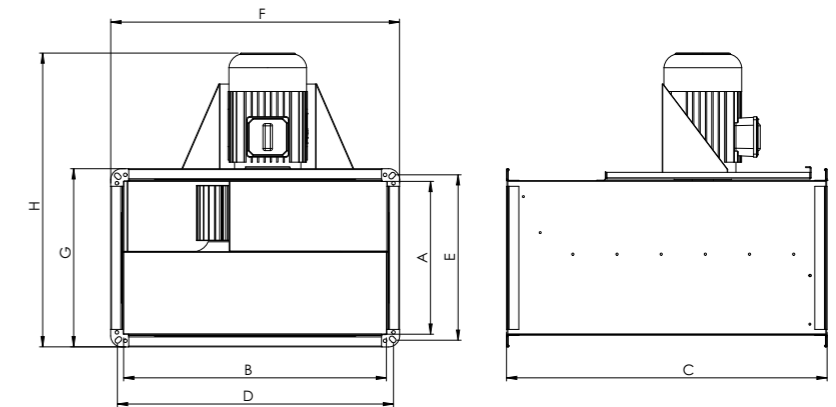

TYPE	A	B	C	D	E	F	G	H
BSKF-R 200	200	400	500	420	220	450	250	469
BSKF-R 225	250	500	560	520	270	550	300	519
BSKF-R 250	300	500	560	520	320	550	350	589
BSKF-R 280	300	600	710	620	320	650	350	589
BSKF-R 315	350	600	710	620	370	650	400	684
BSKF-R 355	400	700	780	720	420	750	450	766
BSKF-R 400	500	800	880	820	520	850	550	866
BSKF-R 450	500	1000	980	1020	520	1050	550	886

Dimensions are in (mm)

TYPE	VOLTAGE	FREQUENCY	POWER	CURRENT	CAPACITOR	SPEED	AIR FLOW	SOUND PRESSURE	INSULATION CLASS	PROTECTION CLASS	WEIGHT
	V	Hz	kW	(A)	(µF)	r.p.m	m³/h	dB(A)	Ins.cl.	IP	kg
BSKF-R 200-4 M	230	50	0,25	2,1	10	1390	1000	53	F	55	22
BSKF-R 225-4 M	230	50	0,37	3,4	15	1400	1673	55	F	55	35
BSKF-R 250-4 M	230	50	0,55	4,5	20	1365	1740	55	F	55	40
BSKF-R 280-4 M	230	50	0,75	4,6	30	1405	2942	60	F	55	43
BSKF-R 315-4 M	230	50	1,5	9,3	50	1410	4050	62	F	55	55
BSKF-R 355-4 M	230	50	2,2	14,2	50	1430	8000	64	F	55	85
BSKF-R 200-4 T	380	50	0,25	0,87	-	1380	1000	53	F	55	22
BSKF-R 225-4 T	380	50	0,37	1,2	-	1390	1673	55	F	55	35
BSKF-R 250-4 T	380	50	0,55	1,6	-	1365	1740	55	F	55	40
BSKF-R 280-4 T	380	50	0,75	2,1	-	1405	2942	60	F	55	43
BSKF-R 315-4 T	380	50	1,5	3,5	-	1410	4050	62	F	55	55
BSKF-R 355-4 T	380	50	2,2	4,9	-	1420	8000	64	F	55	85
BSKF-R 355-6 T	380	50	1,1	2,9	-	930	5200	53	F	55	85
BSKF-R 400-6 T	380	50	1,5	3,6	-	945	6000	55	F	55	92
BSKF-R 450-6 T	380	50	2,2	5,4	-	950	7500	58	F	55	120

Sound Level Measured from 3m distance in room condition.

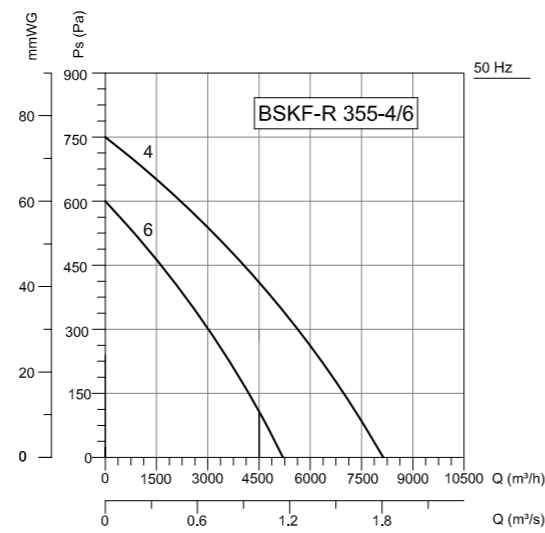
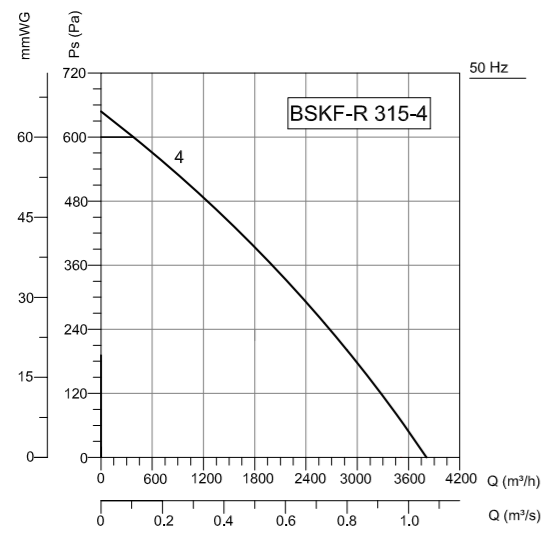
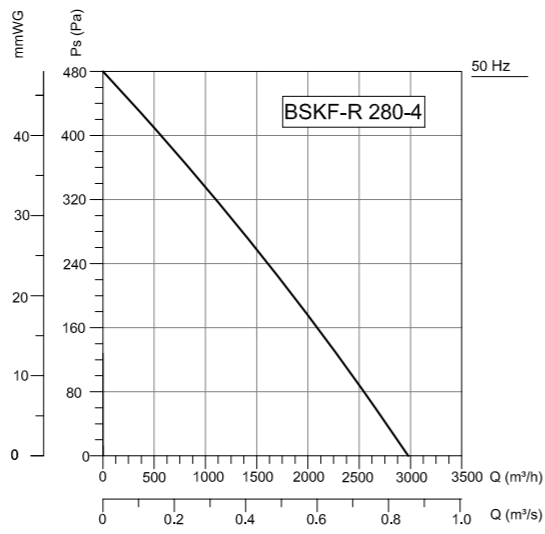
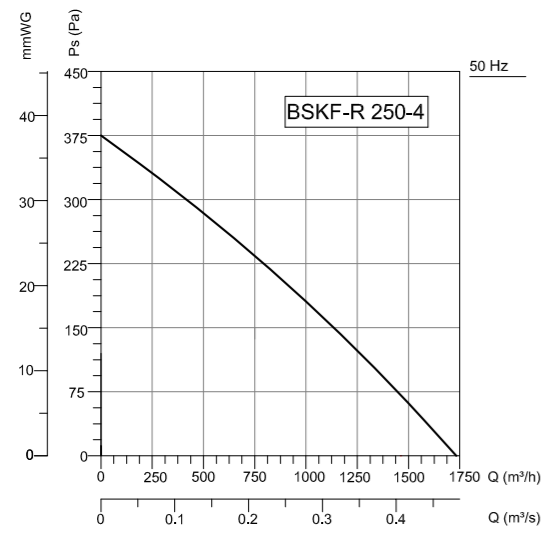
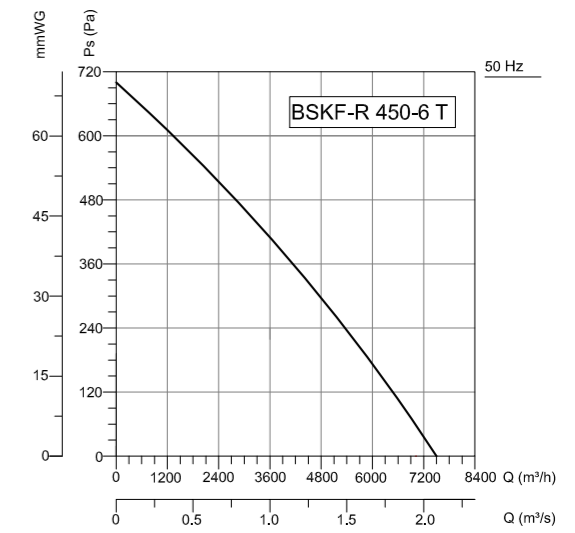
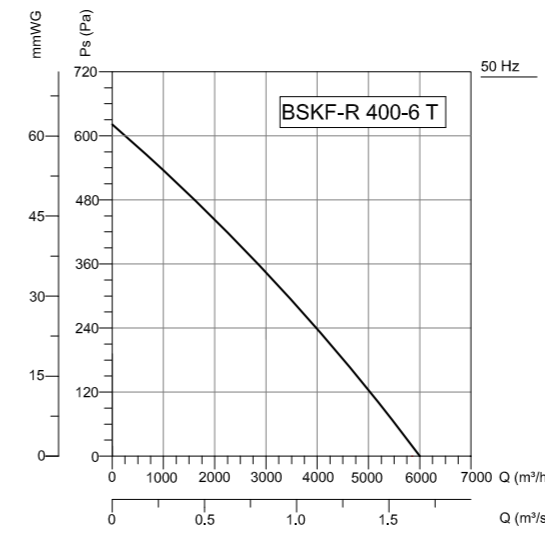
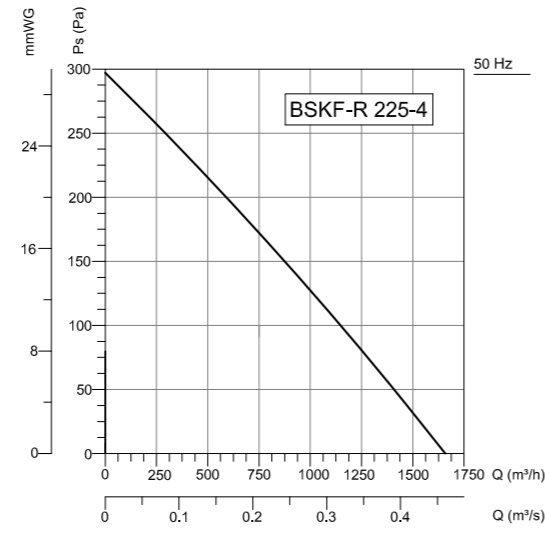
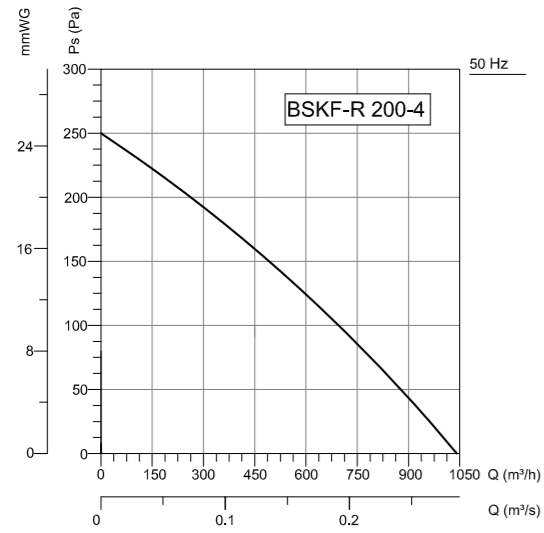

Accessories





BDKF-R EX PROOF

RECTANGULAR DUCT FANS / Backward Curved

Fan Components and Material Properties

Rectangular body is manufactured from galvanized steel sheet. The fans of the Bdkf-r 315-355-400 are made of high quality galvanized steel which is resistant to corrosion. The fans of the Bdkf-r 450-500-560 models are made of aluminum sheet. All models are equipped with Ex Proof asynchronous motor. Suction flange is made of copper material. The motor is out of airflow. The device is capable of carrying air at max.120°C.

Fan Structure

It is designed to work between the rectangular channel. The fan blades are aerodynamically curved and provide regular flow. The fans are composed of backward sloping and infrequently arranged fins.

Benefits

Designed to be non-sparking. Since the motor is out of airflow, it is resistant to high temperature. The swing-out lid allows the product to be maintained effortlessly without removing the fan. Thanks to the aerodynamic wing structure, they work quietly. Speed can be adjusted with speed control devices.

Usage Areas

Ex-proof fans are one of the preferred fan types for the ventilation of high-risk environments. It is designed to be non-sparking. Usage areas are determined according to the degree of Atex directive.

Technical Drawing and Tables

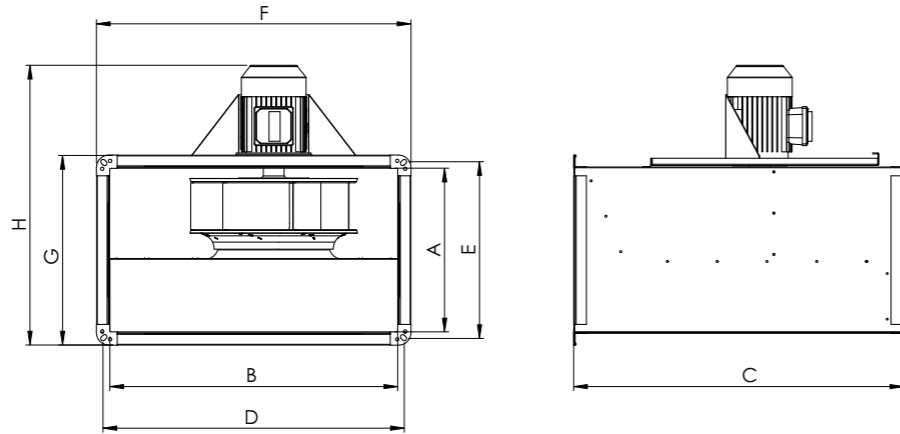

TYPE	A	B	C	D	E	F	G	H
BDKF-R-EX 315 T	350	600	750	620	370	650	400	550
BDKF-R-EX 355 T	350	600	750	620	370	650	400	650
BDKF-R-EX 400 T	400	700	800	720	420	750	450	630
BDKF-R-EX 450 T	400	700	800	720	420	750	450	630
BDKF-R-EX 500 T	500	800	920	820	520	850	560	780
BDKF-R-EX 560 T	500	1000	1050	1030	530	1060	560	780

Dimensions are in (mm)

TYPE	VOLTAGE	FREQUENCY	POWER	CURRENT	CAPACITOR	SPEED	AIR FLOW	SOUND PRESSURE	INSULATION CLASS	PROTECTION CLASS	WEIGHT
	V	Hz	kW	(A)	(µF)	r.p.m	m ³ /h	dB(A)	Ins.cl.	IP	kg
BDKF-R-EX 315 T	380	50	0,25	0,87	-	1380	2000	53	F	55	35
BDKF-R-EX 355 T	380	50	0,25	0,87	-	1380	3000	58	F	55	36
BDKF-R-EX 400 T	380	50	0,37	1,2	-	1390	4100	56	F	55	49
BDKF-R-EX 450 T	380	50	0,55	1,6	-	1395	5500	58	F	55	52
BDKF-R-EX 500 T	380	50	1,1	2,6	-	1410	8100	64	F	55	74
BDKF-R-EX 560 T	380	50	2,2	4,9	-	1420	10500	66	F	55	91

Sound Level Measured from 3m distance in room condition.

Accessories

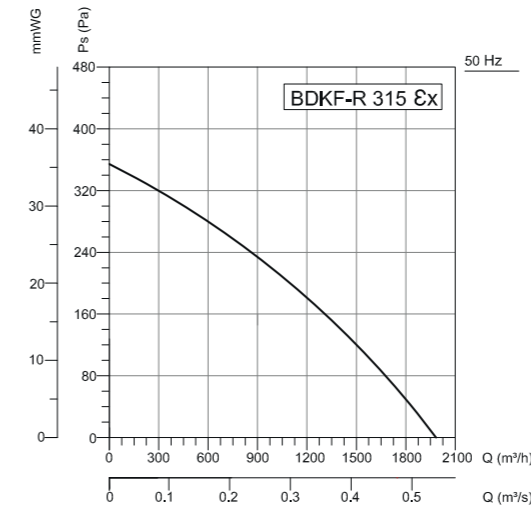

Frequency	Tot	63	125	250	500	1000	2000	4000	8000	Hz
L _{wa} Inlet	70	50	65	61	63	60	61	56	48	dB(A)
L _{wa} Outlet	76	54	72	68	69	68	67	62	54	dB(A)
L _{wa} Surrounding	60	27	57	53	50	49	48	49	37	dB(A)

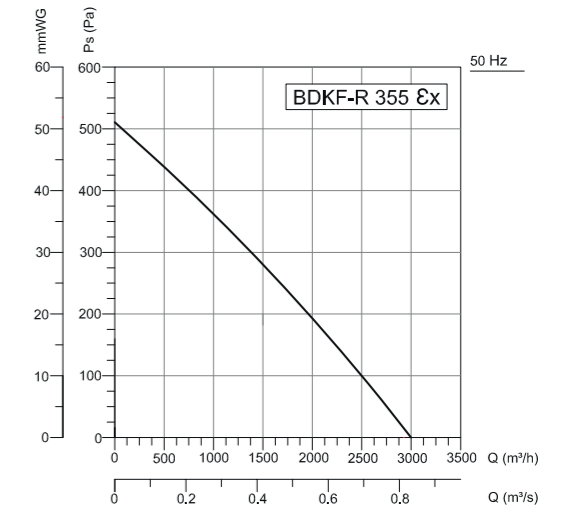

Frequency	Tot	63	125	250	500	1000	2000	4000	8000	Hz
L _{wa} Inlet	74	50	61	67	65	68	66	63	60	dB(A)
L _{wa} Outlet	78	51	61	69	71	71	73	67	70	dB(A)
L _{wa} Surrounding	65	33	40	59	57	59	58	50	47	dB(A)

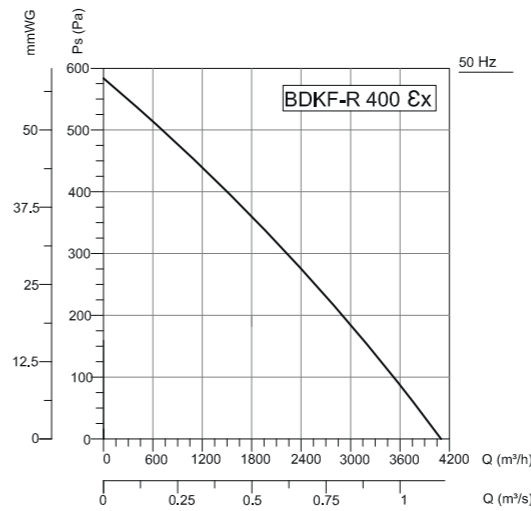

Frequency	Tot	63	125	250	500	1000	2000	4000	8000	Hz
L _{wa} Inlet	73	58	68	64	66	66	62	56	50	dB(A)
L _{wa} Outlet	77	62	68	70	71	71	69	61	55	dB(A)
L _{wa} Surrounding	63	40	60	57	52	51	46	38	35	dB(A)

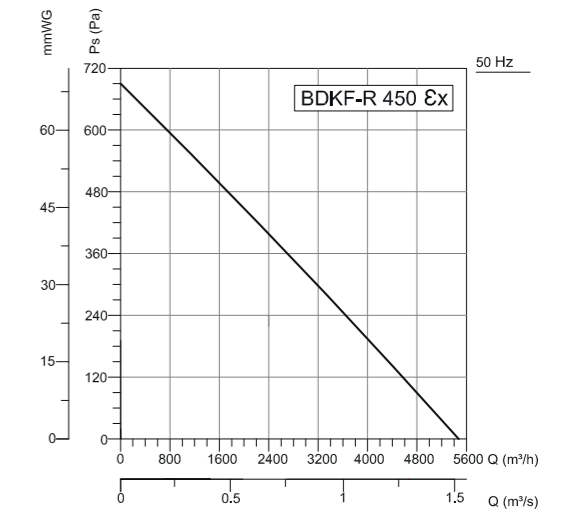

Frequency	Tot	63	125	250	500	1000	2000	4000	8000	Hz
L _{wa} Inlet	70	50	65	61	63	60	61	56	48	dB(A)
L _{wa} Outlet	76	54	72	68	69	68	67	62	54	dB(A)
L _{wa} Surrounding	60	27	57	53	50	49	48	49	37	dB(A)

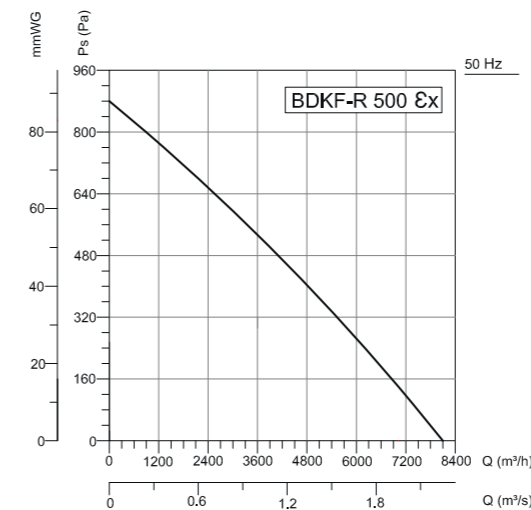

Frequency	Tot	63	125	250	500	1000	2000	4000	8000	Hz
L _{wa} Inlet	79	61	72	71	73	71	71	66	58	dB(A)
L _{wa} Outlet	84	66	75	76	77	79	75	70	61	dB(A)
L _{wa} Surrounding	71	45	68	64	61	61	60	54	43	dB(A)

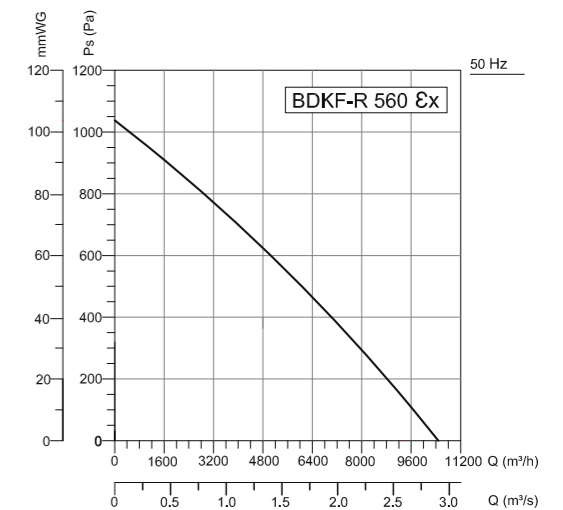

Frequency	Tot	63	125	250	500	1000	2000	4000	8000	Hz
L _{wa} Inlet	84	70	77	76	78	78	75	71	65	dB(A)
L _{wa} Outlet	89	71	80	81	82	83	80	74	65	dB(A)
L _{wa} Surrounding	73	58	70	65	63	61	58	54	50	dB(A)



BKEF-R

KITCHEN EXHAUST FANS / Backward Curved

Fan Components and Material Properties

The double-walled body with heat and sound insulation is manufactured from galvanized sheet metal. The fan of the Bkef-R 400 is made of high quality galvanized steel which is resistant to corrosion. The fans of the Bkef-r 450-500-560 models are made of aluminum sheet. All models use an asynchronous motor and the motor is out of airflow. The device is capable of carrying air at max.120°C.

Fan Structure

The fan blades are aerodynamically curved and provide regular flow. The fans are composed of backward sloping and infrequently arranged fins.

*Filtered applications are optional. Please contact BVN representatives.

Benefits

Since the motor is out of airflow, it is resistant to high temperature. The opening cover allows for effortless maintenance of the product. Right-left-top can be changed in three different ways. Water drainage feature. They work quietly thanks to isolation. Speed can be adjusted with speed control devices.

Speed Control

Optional control devices can be provided. Speed control can be done with frequency inverter in 3 ~ phase products. (see BSC-F accessory)

Usage Areas

They are used for smoke evacuation with grease trap filter in dense oily environments such as restaurant kitchens. It is able to carry air at higher temperatures due to the motor being out of airflow.

Technical Drawing and Tables

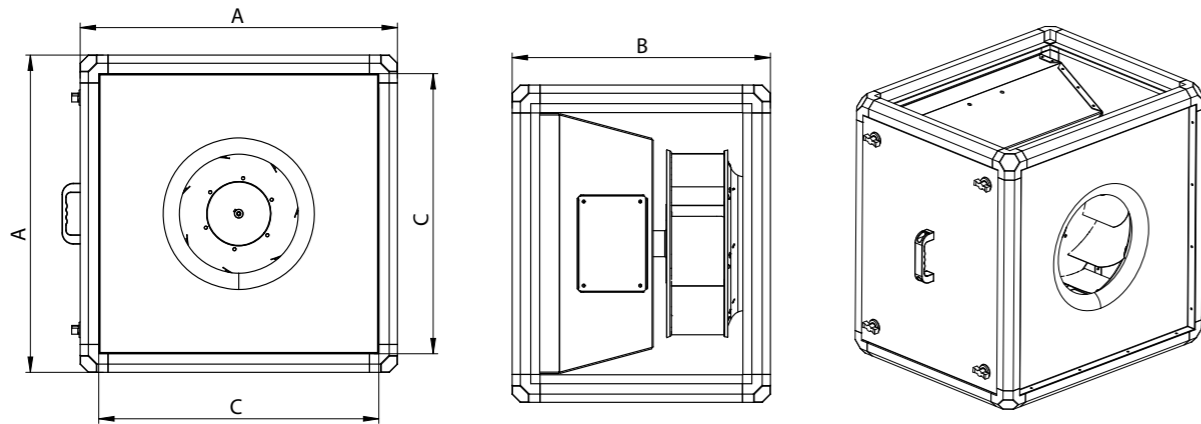

TYPE	A	B	C
BKEF-R 400	683	556	603
BKEF-R 450	683	572	603
BKEF-R 500	683	623	603
BKEF-R 560	813	690	733

Dimensions are in (mm)

TYPE	VOLTAGE	FREQUENCY	POWER	CURRENT	CAPACITOR	SPEED	AIR FLOW	SOUND PRESSURE	INSULATION CLASS	PROTECTION CLASS	WEIGHT
	V	Hz	kW	(A)	(µF)	r.p.m	m ³ /h	dB(A)	Ins.cl.	IP	kg
BKEF-R 400M	230	50	0,37	3,4	15	1390	4100	45	F	55	52
BKEF-R 450M	230	50	0,55	4,5	20	1365	5400	48	F	55	65
BKEF-R 500M	230	50	1,1	7,5	35	1410	8200	52	F	55	77
BKEF-R 560M	230	50	2,2	14,2	50	1420	10800	55	F	55	95
BKEF-R 400T	380	50	0,37	1,2	-	1390	4100	45	F	55	52
BKEF-R 450T	380	50	0,55	1,6	-	1365	5400	48	F	55	65
BKEF-R 500T	380	50	1,1	2,6	-	1410	8200	52	F	55	77
BKEF-R 560T	380	50	2,2	4,9	-	1420	10800	55	F	55	95

Sound Level Measured from 3m distance in room condition.

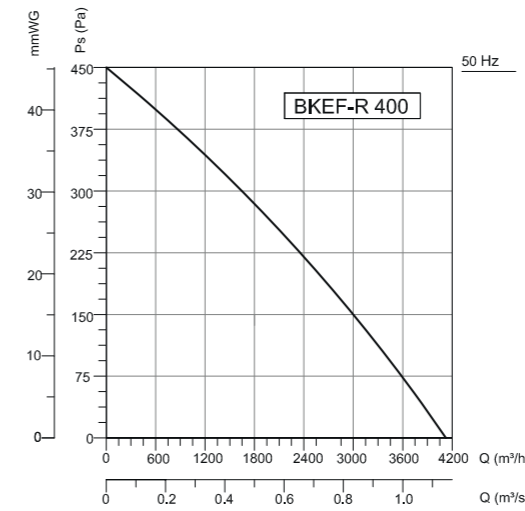

Frequency	Tot	63	125	250	500	1000	2000	4000	8000	Hz
L _{wa} Inlet	68	55	57	61	63	62	59	54	47	dB(A)
L _{wa} Outlet	70	57	59	63	65	64	61	56	49	dB(A)
L _{wa} Surrounding	52	39	41	45	47	46	43	38	31	dB(A)

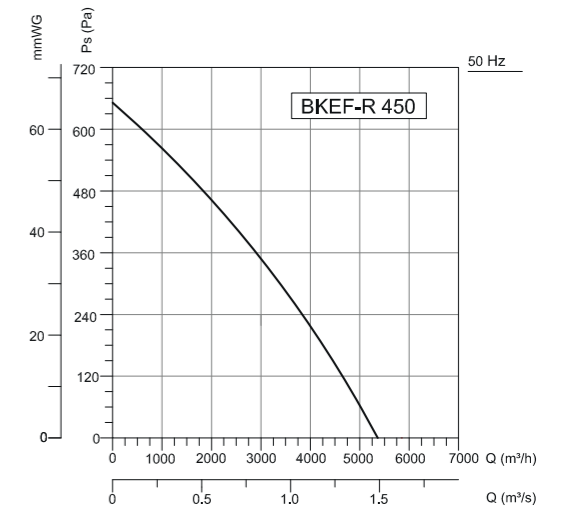

Frequency	Tot	63	125	250	500	1000	2000	4000	8000	Hz
L _{wa} Inlet	70	57	59	63	65	64	61	46	49	dB(A)
L _{wa} Outlet	72	59	61	65	67	66	63	58	51	dB(A)
L _{wa} Surrounding	55	42	44	48	50	49	46	41	34	dB(A)

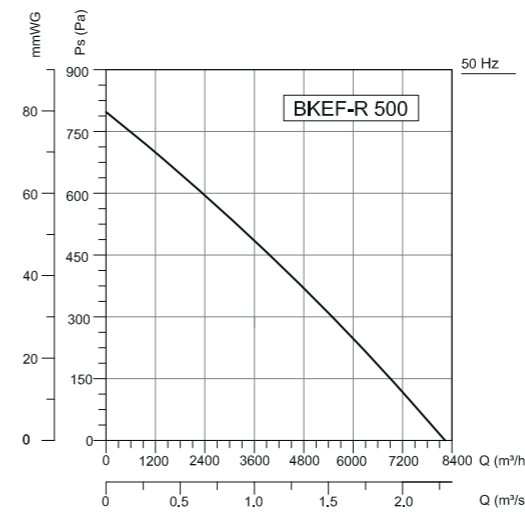

Frequency	Tot	63	125	250	500	1000	2000	4000	8000	Hz
L _{wa} Inlet	74	61	63	67	69	68	65	60	53	dB(A)
L _{wa} Outlet	76	63	65	69	71	70	67	62	55	dB(A)
L _{wa} Surrounding	59	46	48	52	54	53	50	45	38	dB(A)

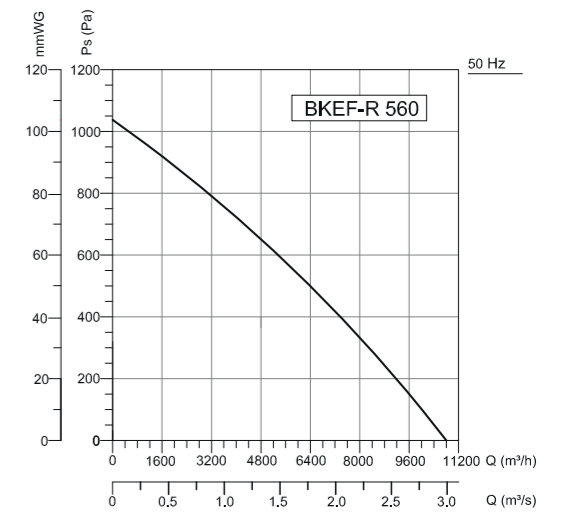

Frequency	Tot	63	125	250	500	1000	2000	4000	8000	Hz
L _{wa} Inlet	76	63	65	69	71	70	67	62	55	dB(A)
L _{wa} Outlet	77	67	66	70	71	71	68	63	56	dB(A)
L _{wa} Surrounding	62	50	52	55	57	56	49	53	42	dB(A)

Accessories





BKEF-RH

KITCHEN EXHAUST FANS / Backward Curved - High Pressure

Fan Components and Material Properties

The double-walled body with heat and sound insulation is manufactured from galvanized sheet metal. 25 mm thick mineral wool was applied for sound and heat insulation. All models of the fan can be removed and installed. All models use asynchronous motor and the motor is out of airflow. The device is capable of carrying air at max.120°C.

Fan Structure

Electrostatic painted and welded plug fan is used. The fan blades are aerodynamically curved and provide regular flow. It is suitable to operate at high speed as it uses a welded plug fan.

*Filtered applications are optional. Please contact BVN representatives.

Benefits

Since the motor is out of airflow, it is resistant to high temperature. It has high performance and high efficiency because it works at high speed. Thanks to the removable panels, smoke can be easily steered. Right-left-top can be changed in three different ways. Water drainage feature. They work quietly thanks to isolation. Occasionally requires wheel cleaning. Speed can be adjusted with speed control devices.

Usage Areas

In restaurants with dense oil like greaseproof environments, it is possible to use commercially available commercial kitchen etc. with smoke trap and long channel distance. Used in environments. It is able to carry air at higher temperatures due to the motor being out of airflow.

Technical Drawing and Tables

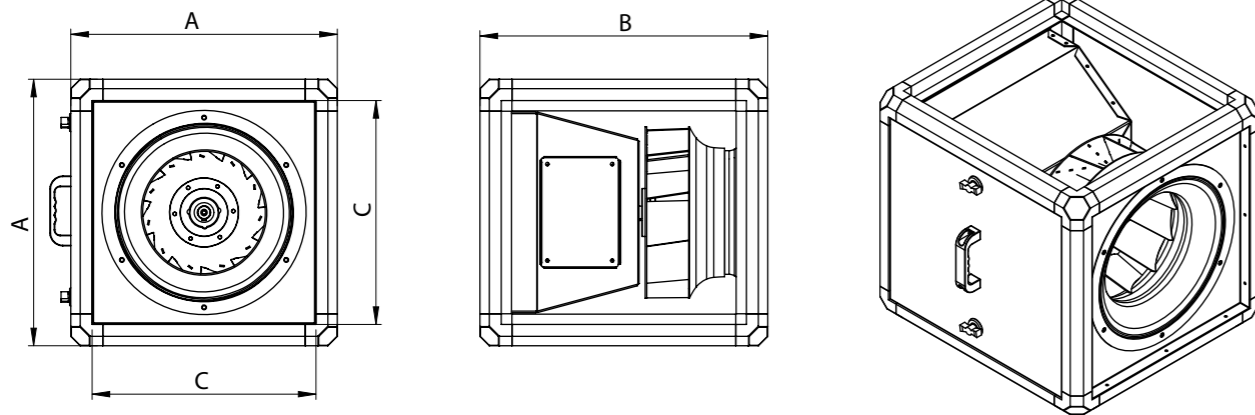

TYPE	A	B	C
BKEF-RH 280	500	500	420
BKEF-RH 315	500	540	420

Dimensions are in (mm)

TYPE	VOLTAGE V	FREQUENCY Hz	POWER kW	CURRENT (A)	CAPACITOR (µF)	SPEED r.p.m	AIR FLOW m³/h	SOUND PRESSURE dB(A)	INSULATION CLASS Ins.cl.	PROTECTION CLASS IP	WEIGHT kg
BKEF-RH 280M	230	50	0,75	5	30	2840	3600	65	F	55	38
BKEF-RH 315M	230	50	1,5	9,8	40	2865	5000	68	F	55	41
BKEF-RH 280T	380	50	0,75	1,8	-	2840	3600	65	F	55	38
BKEF-RH 315T	380	50	1,5	3,3	-	2865	5000	68	F	55	41

Sound Level Measured from 3m distance in room condition.

Accessories

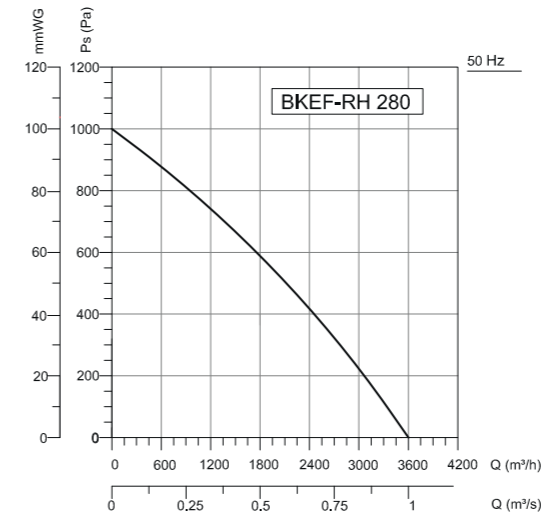

Frequency	Tot	63	125	250	500	1000	2000	4000	8000 Hz
L _{wa} Inlet	86	72	74	78	80	79	76	71	74 dB(A)
L _{wa} Outlet	86	76	75	79	80	80	77	72	65 dB(A)
L _{wa} Surrounding	71	59	61	64	66	65	58	62	51 dB(A)

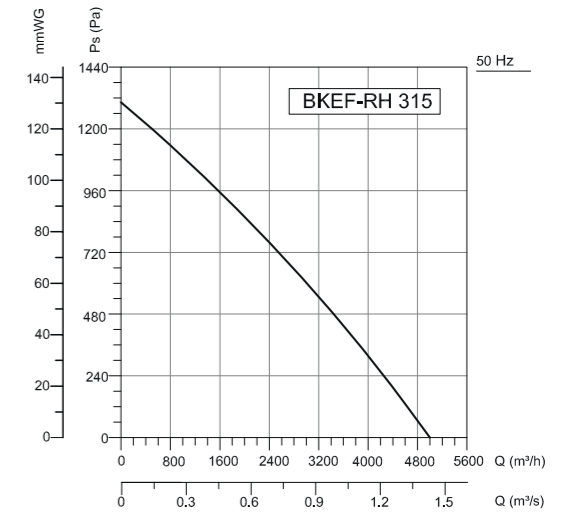

Frequency	Tot	63	125	250	500	1000	2000	4000	8000 Hz
L _{wa} Inlet	90	76	78	82	84	84	80	75	68 dB(A)
L _{wa} Outlet	90	80	79	83	84	84	82	76	69 dB(A)
L _{wa} Surrounding	75	63	65	68	70	69	62	66	55 dB(A)





BKEF

KITCHEN EXHAUST FANS / Backward Curved

Fan Components and Material Properties

The body with heat and sound insulation is manufactured from galvanized sheet metal. The fans of the Bkef 315-355-400 are made of high quality galvanized steel that is resistant to corrosion. The fans of the Bkef 450-500-560 models are made of aluminum sheet. Asynchronous motor is used in all models. The motor is out of airflow. The device is capable of carrying air at max.120°C.

Fan Structure

The fan blades are aerodynamically curved and provide regular flow. The fans are composed of backward sloping and infrequently arranged fins.

Benefits

Since the motor is out of airflow, it is resistant to high temperature. The opening cover allows for effortless maintenance of the product. Water drainage feature. They work quietly thanks to isolation. Speed can be adjusted with speed control devices.

Speed Control

Optional control devices can be provided. Speed control can be done with frequency inverter in 3-phase products. (see BSC-F accessory)

Usage Areas

They are used for smoke evacuation with grease trap filter in dense oily environments such as restaurant kitchens. It is able to carry air at higher temperatures due to the motor being out of airflow.

Technical Drawing and Tables

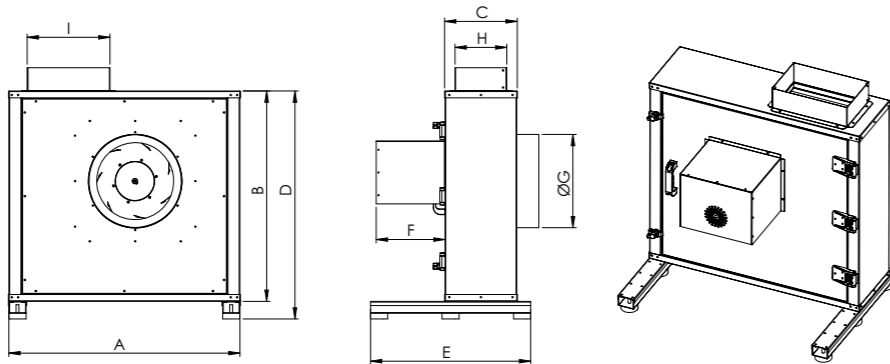

TYPE	A	B	C	D	E	F	G	H	J
BKEF 315	650	605	220	665	480	245	250	160	230
BKEF 355	730	655	230	715	480	245	280	170	260
BKEF 400	815	740	255	800	580	245	330	185	295
BKEF 450	905	810	270	870	580	245	350	210	325
BKEF 500	1005	900	335	990	635	280	400	280	355
BKEF 560	1105	1000	365	1090	715	330	455	310	455

Dimensions are in (mm)

TYPE	VOLTAGE	FREQUENCY	POWER	CURRENT	CAPACITOR	SPEED	AIR FLOW	SOUND PRESSURE	INSULATION CLASS	PROTECTION CLASS	WEIGHT
	V	Hz	kW	(A)	(µF)	r.p.m	m³/h	dB(A)	Ins.cl.	IP	kg
BKEF 315M	230	50	0,25	2,1	10	1390	1800	37-29	F	55	51
BKEF 355M	230	50	0,25	2,1	10	1390	2800	41-33	F	55	63
BKEF 400M	230	50	0,37	3,4	15	1400	4000	42-34	F	55	78
BKEF 450M	230	50	0,55	4,5	20	1410	5200	45-37	F	55	87
BKEF 500M	230	50	1,1	7,5	35	1400	8000	49-42	F	55	120
BKEF 560M	230	50	2,2	14,2	50	1430	10000	52-44	F	55	145
BKEF 315T	380	50	0,25	0,87	-	1380	1800	37-29	F	55	51
BKEF 355T	380	50	0,25	0,87	-	1380	2800	41-33	F	55	63
BKEF 400T	380	50	0,37	1,2	-	1390	4000	42-34	F	55	78
BKEF 450T	380	50	0,55	1,6	-	1365	5200	45-37	F	55	87
BKEF 500T	380	50	1,1	2,6	-	1410	8000	49-42	F	55	120
BKEF 560T	380	50	2,2	4,9	-	1420	10000	52-44	F	55	145

The sound level is measured at a distance of 4-10 m in open field condition.

Accessories

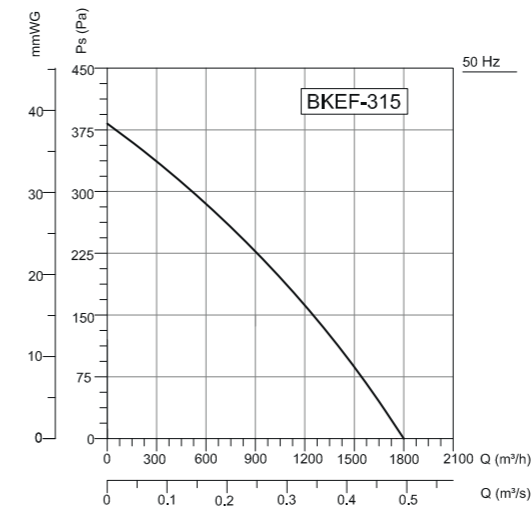
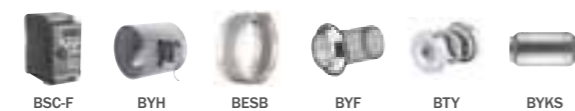

Frequency	Tot	63	125	250	500	1000	2000	4000	8000	Hz
L _{wa} Inlet	78	74	73	68	66	62	56	53	53	dB(A)
L _{wa} Outlet	80	76	75	70	67	64	58	55	55	dB(A)
L _{wa} Surrounding	60	56	55	50	48	44	38	35	35	dB(A)

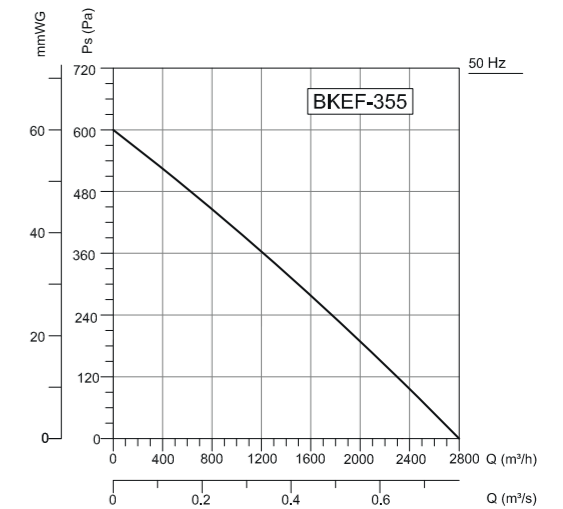

Frequency	Tot	63	125	250	500	1000	2000	4000	8000	Hz
L _{wa} Inlet	82	78	77	72	70	66	60	57	57	dB(A)
L _{wa} Outlet	84	80	79	74	72	68	62	59	59	dB(A)
L _{wa} Surrounding	64	60	59	54	52	48	42	39	39	dB(A)

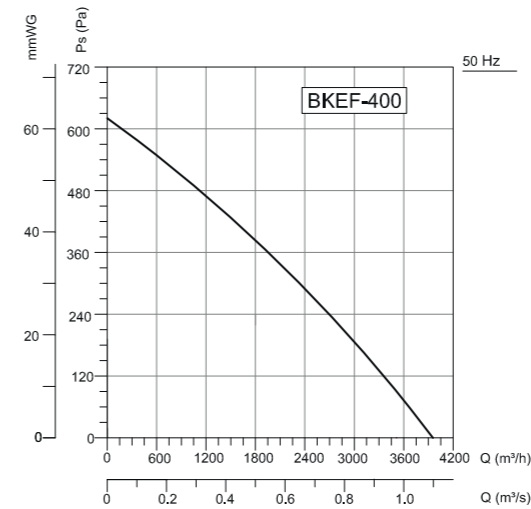

Frequency	Tot	63	125	250	500	1000	2000	4000	8000	Hz
L _{wa} Inlet	83	79	78	73	71	67	61	58	58	dB(A)
L _{wa} Outlet	85	81	80	75	73	69	63	60	60	dB(A)
L _{wa} Surrounding	65	61	60	55	53	49	43	40	40	dB(A)

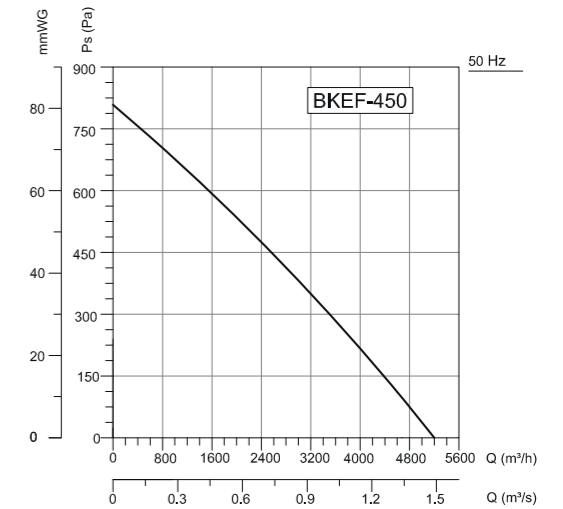

Frequency	Tot	63	125	250	500	1000	2000	4000	8000	Hz
L _{wa} Inlet	86	82	81	76	74	70	64	61	61	dB(A)
L _{wa} Outlet	88	84	83	78	76	75	66	63	63	dB(A)
L _{wa} Surrounding	68	64	63	58	56	52	46	43	43	dB(A)

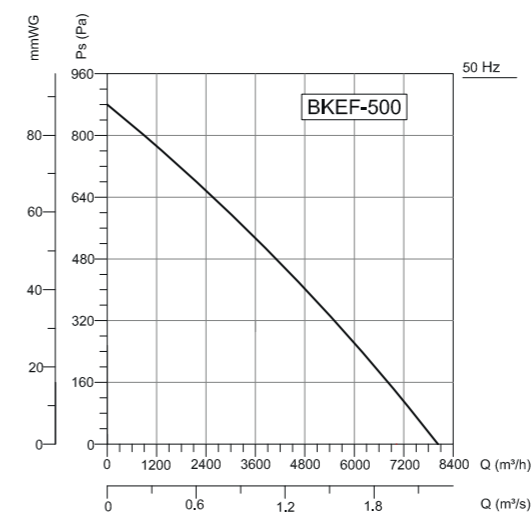

Frequency	Tot	63	125	250	500	1000	2000	4000	8000	Hz
L _{wa} Inlet	88	85	84	79	75	73	67	64	64	dB(A)
L _{wa} Outlet	91	87	86	81	79	78	69	66	66	dB(A)
L _{wa} Surrounding	71	67	66	61	59	55	49	46	46	dB(A)

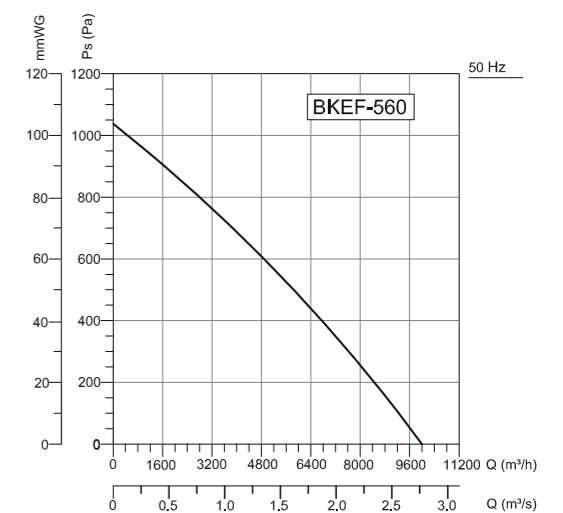

Frequency	Tot	63	125	250	500	1000	2000	4000	8000	Hz
L _{wa} Inlet	91	88	87	82	78	76	70	67	67	dB(A)
L _{wa} Outlet	94	90	89	84	82	81	72	69	69	dB(A)
L _{wa} Surrounding	74	70	69	64	62	58	52	49	49	dB(A)



BKEF-T

KITCHEN FANS / Forward Curved

Fan Components and Material Properties
The rectangular body and the impellers of the fans are made of high quality galvanized steel which is resistant to corrosion. Motor protection cover. The BSKF-R is equipped with an asynchronous motor outside the air flow. The device is capable of carrying air at max.120°C.

Fan Structure
Double-walled galvanized body and galvanized forward inclined fan impeller. The fan blades are forward-curved, combined with the plug-in technique and produced in an aerodynamic manner to ensure regular flow. It is designed to work between the rectangular channel. Opening direction interchangeable cover is available.

Benefits
Since the motor is out of airflow, it is resistant to high temperature. The swing-out lid allows the product to

be maintained effortlessly without removing the fan. The housing with fan connection and anti-vibration mountings are included in the isolated base frame. Thanks to the aerodynamic wing structure, they work quietly. Speed can be adjusted with speed control devices. 50 mm thick mineral wool was applied for sound and heat insulation. Water drainage feature.

Speed Control
Optional control devices can be provided. 3 ~ phase products can be controlled with frequency inverter speed control. (see BSC-F accessory)

Usage Areas
It is able to carry air at higher temperatures due to the motor being out of airflow. It should be used with a filter in kitchens that do not contain oil particles. The kitchen can also be used for ambient air ventilation. In order to achieve long service life, fan blade cleaning should be considered.

Technical Drawing and Tables

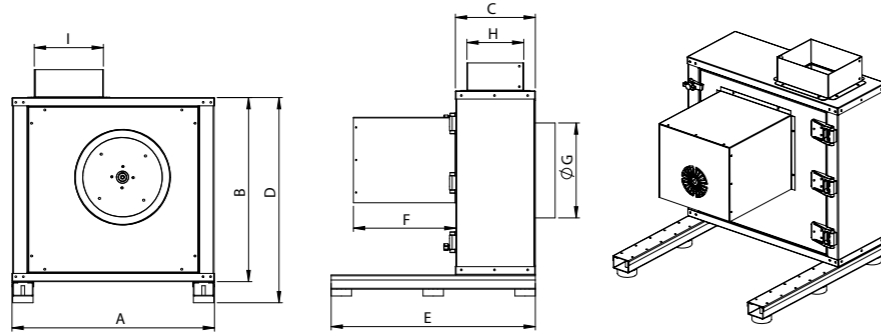

TYPE	A	B	C	D	E	F	G	H	I
BKEF-T 200	460	415	210	475	500	240	200	145	145
BKEF-T 225	495	460	210	520	500	240	210	145	165
BKEF-T 250	535	480	230	545	550	300	250	165	180
BKEF-T 280	595	540	235	605	600	300	280	170	205
BKEF-T 315	650	600	265	660	650	340	335	188	225
BKEF-T 355	730	660	310	820	650	405	340	210	256

Dimensions are in (mm)

TYPE	VOLTAGE	FREQUENCY	POWER	CURRENT	CAPACITOR	SPEED	AIR FLOW	SOUND PRESSURE	INSULATION CLASS	PROTECTION CLASS	WEIGHT
	V	Hz	kW	(A)	(µF)	r.p.m	m ³ /h	dB(A)	Ins.cl.	IP	kg
BKEF-T 200M	230	50	0,55	4,5	20	1365	1750	40	F	55	40
BKEF-T 225M	230	50	0,75	4,6	30	1405	2250	42	F	55	43
BKEF-T 250M	230	50	1,5	9,3	50	1410	3500	45	F	55	52
BKEF-T 280M	230	50	1,5	9,3	50	1410	4200	48	F	55	63
BKEF-T 315M	230	50	3	19	60	1425	5000	50	F	55	78
BKEF-T 200T	380	50	0,55	1,6	-	1365	1750	40	F	55	40
BKEF-T 225T	380	50	0,75	2,1	-	1405	2250	42	F	55	43
BKEF-T 250T	380	50	1,5	3,5	-	1410	3500	45	F	55	52
BKEF-T 280T	380	50	1,5	3,5	-	1410	4200	48	F	55	63
BKEF-T 315T	380	50	3	6,9	-	1425	5000	50	F	55	78
BKEF-T 355T	380	50	3	6,9	-	960	6000	45	F	55	85

The sound level is measured at a distance of 4-10 m in open field condition.

Accessories

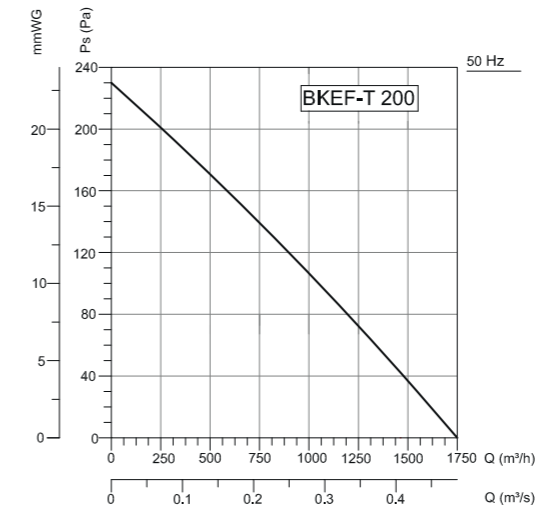
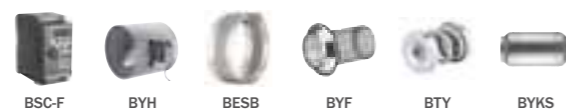

Frequency	Tot	63	125	250	500	1000	2000	4000	8000	Hz
L _{wa} Inlet	81	79	75	72	68	66	62	58	58	dB(A)
L _{wa} Outlet	83	81	77	74	70	68	64	60	60	dB(A)
L _{wa} Surrounding	63	61	57	54	50	48	44	40	40	dB(A)

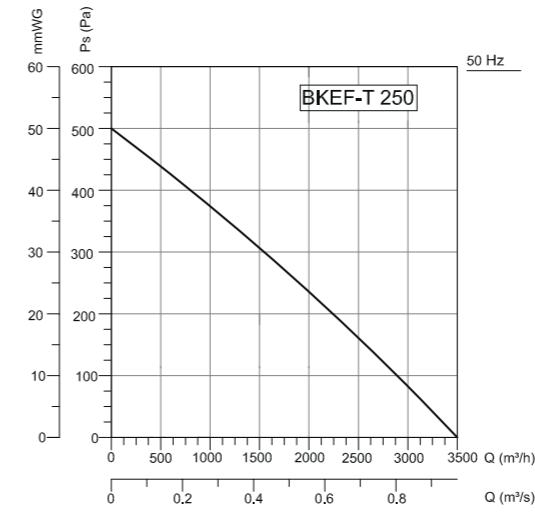

Frequency	Tot	63	125	250	500	1000	2000	4000	8000	Hz
L _{wa} Inlet	89	84	86	75	73	72	68	64	64	dB(A)
L _{wa} Outlet	88	86	81	80	75	74	69	64	64	dB(A)
L _{wa} Surrounding	68	65	61	60	56	54	49	45	45	dB(A)

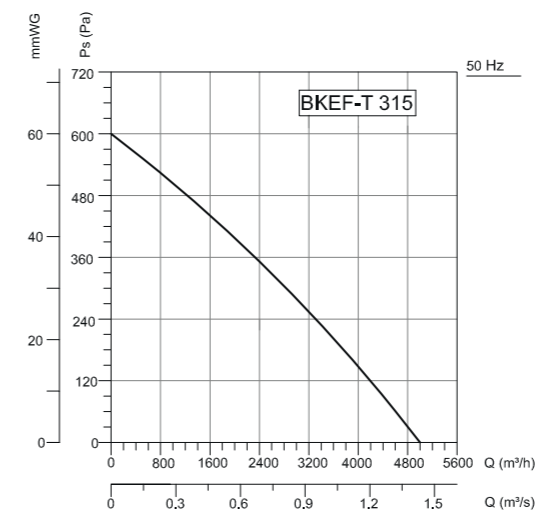

Frequency	Tot	63	125	250	500	1000	2000	4000	8000	Hz
L _{wa} Inlet	91	89	85	82	78	76	72	68	68	dB(A)
L _{wa} Outlet	93	91	87	84	80	78	74	70	70	dB(A)
L _{wa} Surrounding	73	71	67	64	60	58	54	48	48	dB(A)

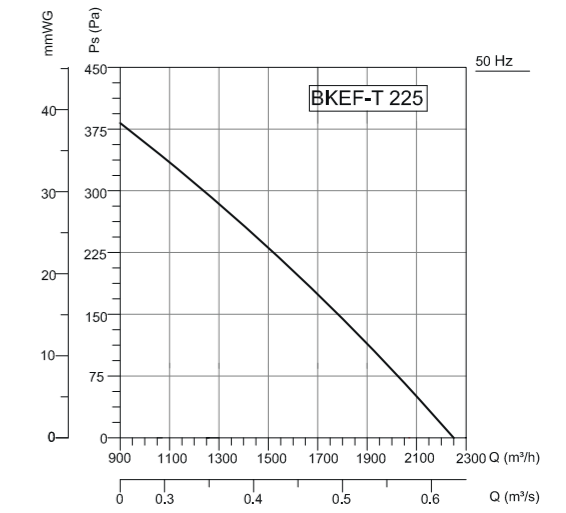

Frequency	Tot	63	125	250	500	1000	2000	4000	8000	Hz
L _{wa} Inlet	83	81	77	74	70	68	64	60	60	dB(A)
L _{wa} Outlet	85	83	79	76	72	70	66	62	62	dB(A)
L _{wa} Surrounding	65	63	59	56	52	50	46	42	42	dB(A)

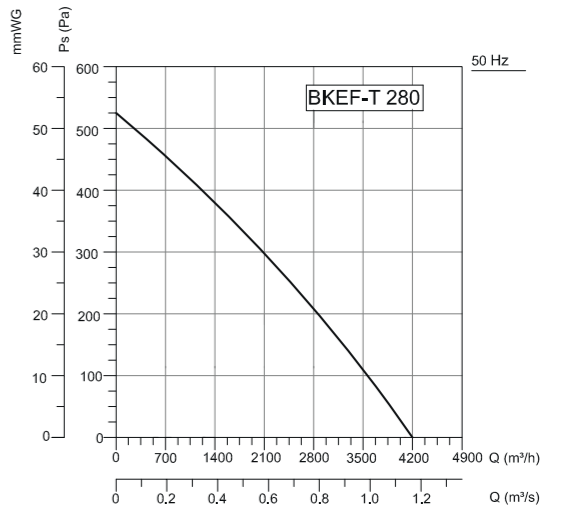

Frequency	Tot	63	125	250	500	1000	2000	4000	8000	Hz
L _{wa} Inlet	89	87	83	80	76	74	70	66	66	dB(A)
L _{wa} Outlet	91	89	85	82	78	76	72	68	68	dB(A)
L _{wa} Surrounding	71	69	65	62	58	56	52	46	46	dB(A)

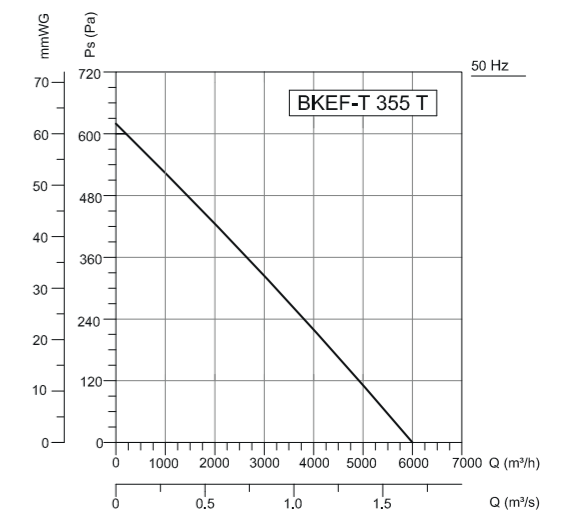

Frequency	Tot	63	125	250	500	1000	2000	4000	8000	Hz
L _{wa} Inlet	88	84	85	76	72	73	68	64	64	dB(A)
L _{wa} Outlet	87	85	80	79	74	73	68	63	63	dB(A)
L _{wa} Surrounding	68	65	61	60	56	54	49	45	45	dB(A)



BHV

CABINET FANS / Forward Curved

Fan Components and Material Properties

The BHV double suction centrifugal box fan housing and fan are made of high quality galvanized steel that is resistant to corrosion. 25 mm stone wool was placed between the panels. Carcass structure is made of aluminum profile. Asynchronous motor belt pulley drive system is used. The device is capable of handling air at max.40°C.

Fan Structure

The fan blades are aerodynamically structured to provide forward flow and regular flow.

Benefits

They provide maximum efficiency with low energy. It is acoustically insulated against sound and it has

*Filtered applications are optional. Please contact BVN representatives.

**Motor outside the airstream options are available.

the feature of vibration-free operation. Thanks to the service cover in the construction, it provides easy intervention to maintenance and faults. Prevents unnecessary pressure losses due to the option of selecting the direction of air blowing and suction nozzles.

Speed Control

Belt pulley system is made by changing the conversion rate.

Usage Areas

Workplaces, offices, factories, hospitals, restaurants etc. used in large quantities where fresh air is required. It must be used with the filter in the exhaust vent.

Technical Drawing and Tables

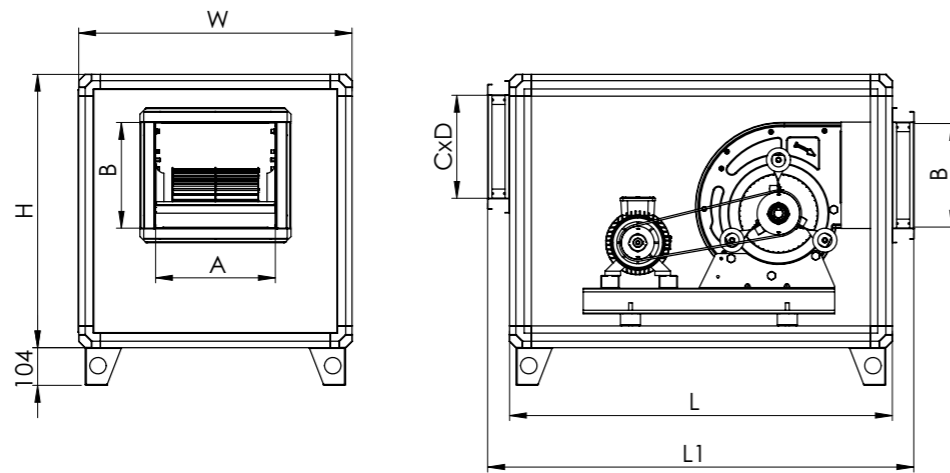

TYPE	L	W	H	L1	A	B	C	D
BHV 7	850	600	600	1050	235	205	520	200
BHV 9	950	700	700	1150	295	260	620	250
BHV 10	1050	750	750	1250	335	290	670	350
BHV 12	1100	850	850	1300	400	335	770	400
BHV 15	1200	900	900	1400	485	408	820	500
BHV 18	1300	1000	1000	1500	560	480	920	600

Dimensions are in (mm)

Accessories



TYPE	VOLTAGE	FREQUENCY	POWER	SPEED	AIR FLOW	PRESSURE	SOUND PRESSURE	WEIGHT
	V	Hz	kW	d/d	m ³ /h	Pa	dB(A)	kg
BHV 7-0,25	220/380	50	0,25	1150	1800	180	49	65
BHV 7-0,37	220/380	50	0,37	1400	2100	220	51	66
BHV 7-0,55	220/380	50	0,55	1520	2350	310	54	68
BHV 7-0,75	220/380	50	0,75	1680	2600	380	57	69
BHV 9-0,37	220/380	50	0,37	990	2500	250	52	75
BHV 9-0,55	220/380	50	0,55	1080	3200	280	53	76
BHV 9-0,75	220/380	50	0,75	1200	3500	300	58	77
BHV 9-1,1	220/380	50	1,1	1300	4000	350	59	80
BHV 10-0,55	220/380	50	0,55	870	3800	200	52	83
BHV 10-0,75	220/380	50	0,75	1000	4200	250	55	84
BHV 10-1,1	220/380	50	1,1	1070	4800	300	58	87
BHV 10-1,5	220/380	50	1,5	1270	5300	400	60	89
BHV 12-0,75	220/380	50	0,75	765	5000	200	53	111
BHV 12-1,1	220/380	50	1,1	920	5500	300	56	114
BHV 12-1,5	220/380	50	1,5	990	6000	350	58	115
BHV 12-2,2	220/380	50	2,2	1080	7000	400	61	120
BHV 15-0,75	220/380	50	0,75	605	6000	190	53	128
BHV 15-1,1	220/380	50	1,1	700	7000	250	55	129
BHV 15-1,5	220/380	50	1,5	765	7800	300	57	131
BHV 15-2,2	220/380	50	2,2	880	9000	400	60	135
BHV 18-1,5	220/380	50	1,5	550	10000	200	57	175
BHV 18-2,2	220/380	50	2,2	610	11000	250	57	176
BHV 18-3	220/380	50	3	690	12000	330	59	177
BHV 18-4	380	50	4	690	13000	300	62	180

Sound Level Measured from 3m distance in room condition.

VENTILATION UNIT INLET-OUTLET DIRECTION

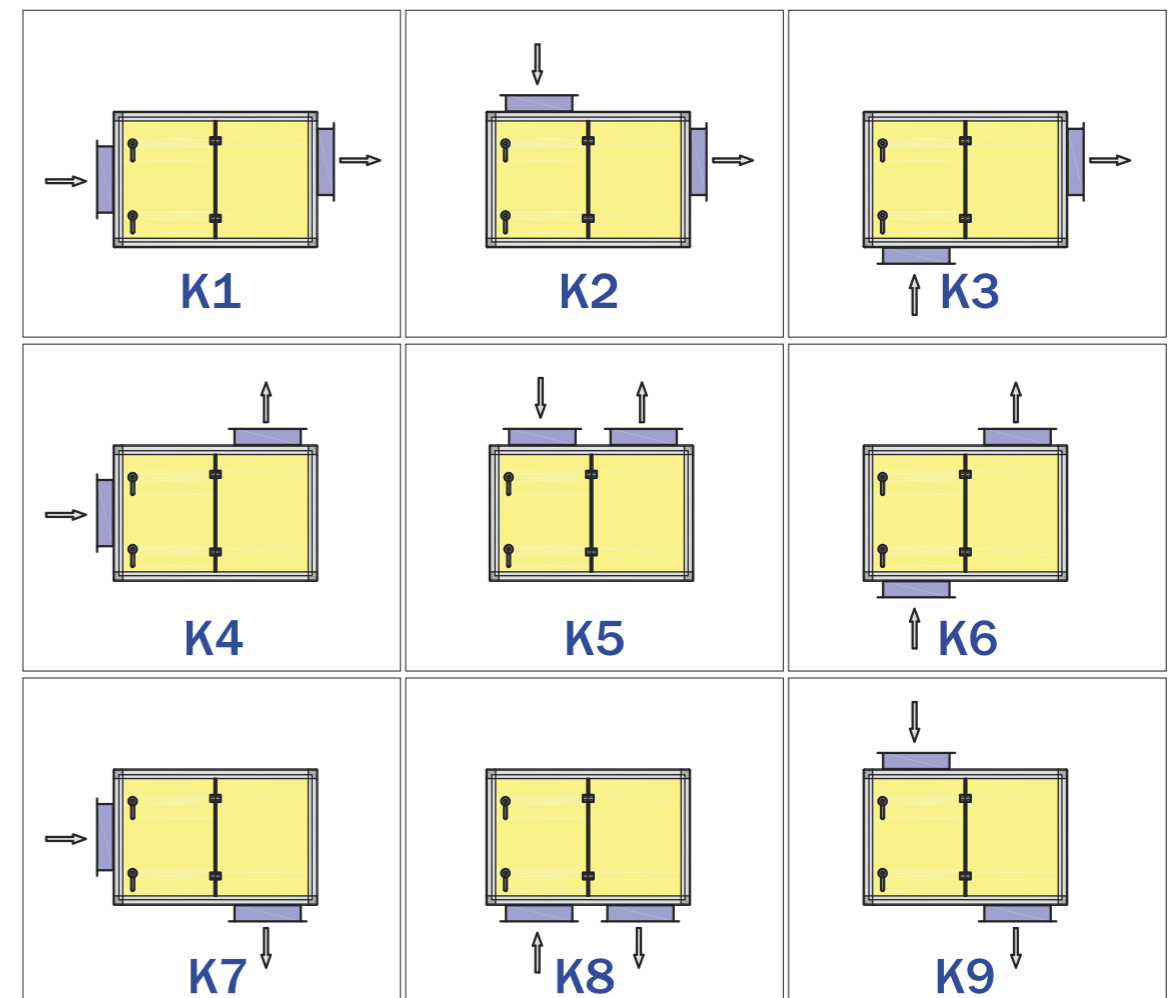

MAINTENANCE DOOR POSITION

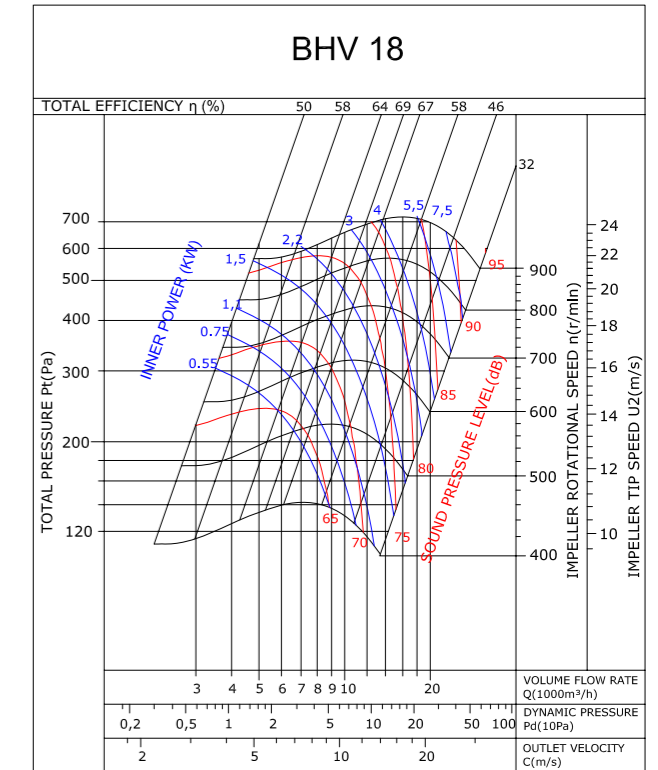
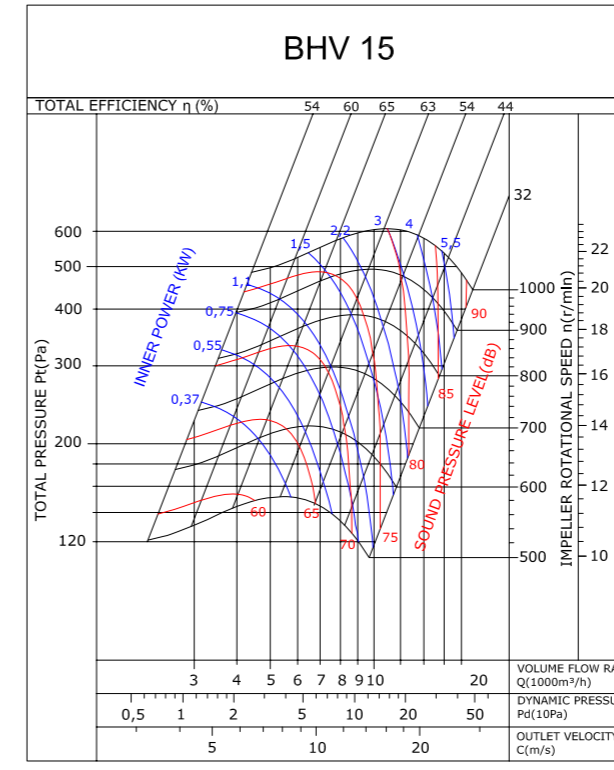
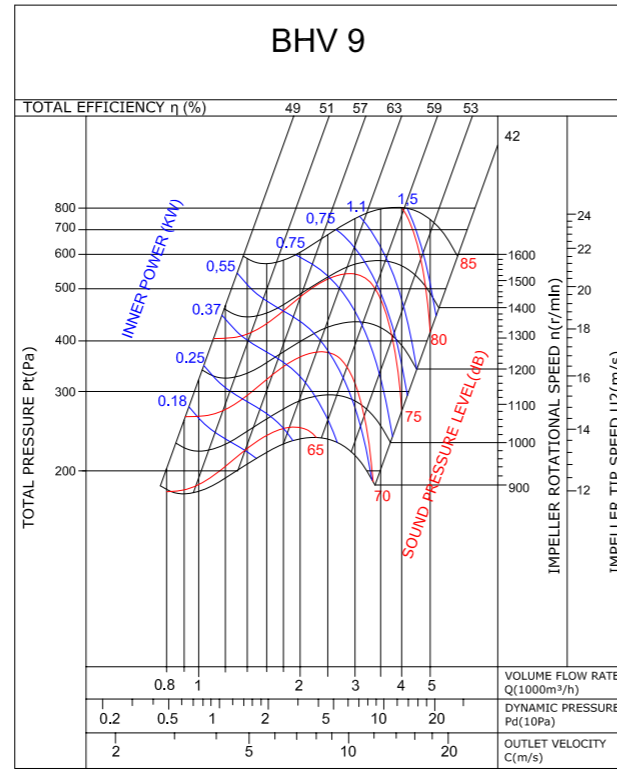
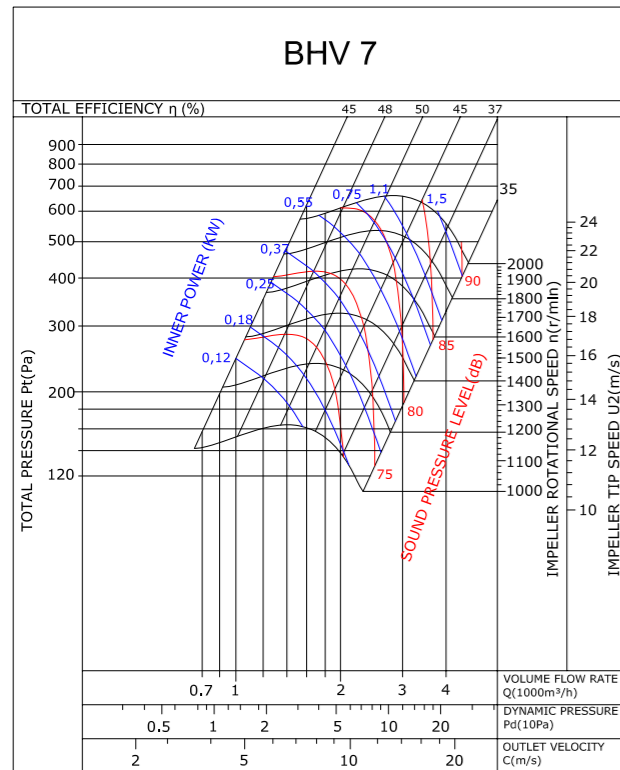
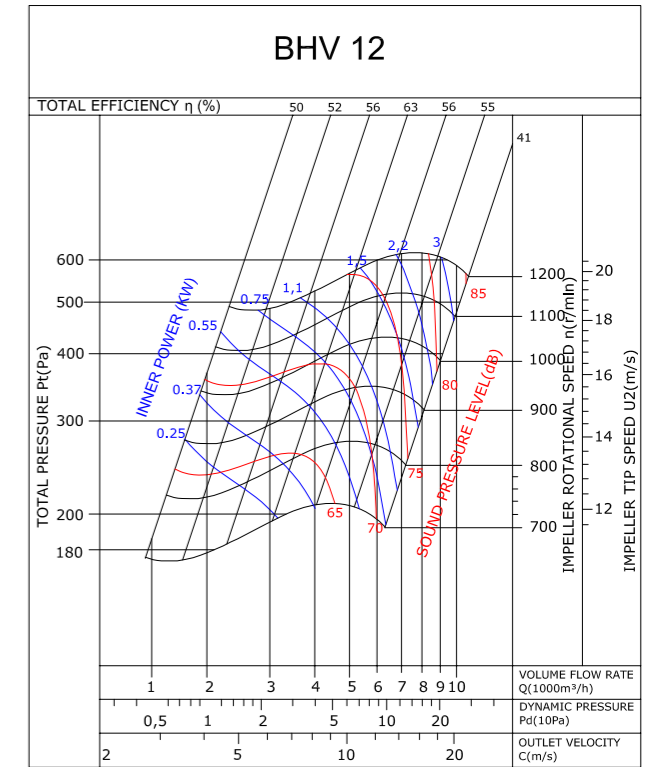
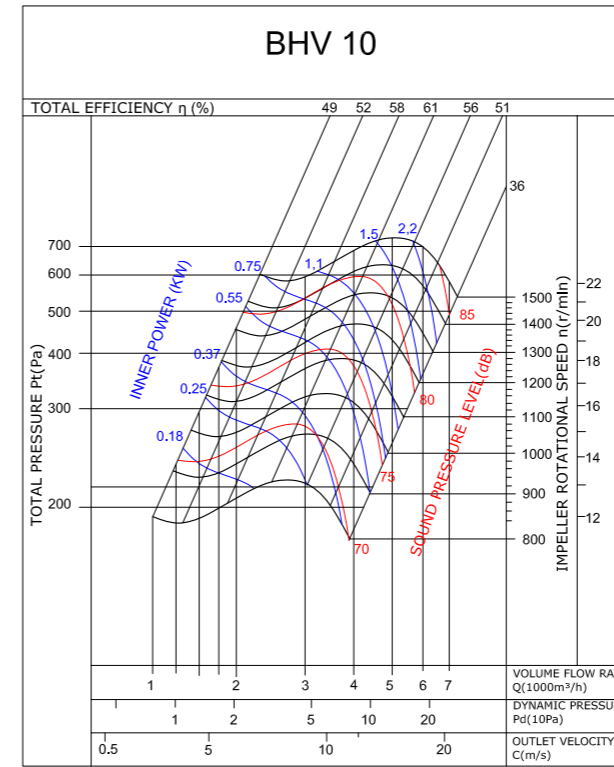
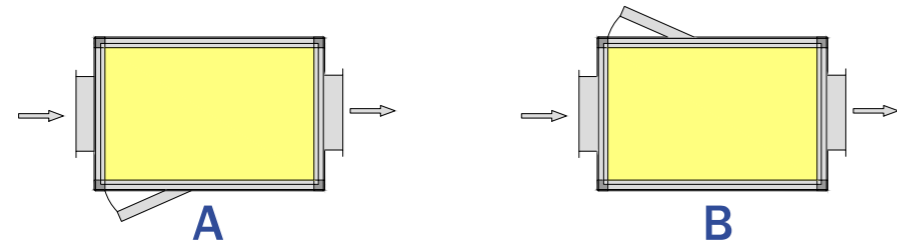



BHV-R

CABINET FANS / Backward Curved

Fan Components and Material Properties

The BHV-R double suction centrifugal box fan housing and fan are made of high-quality galvanized steel that is resistant to corrosion. 25 mm stone wool was placed between the panels. Car-cass structure is made of aluminum profile. Asynchronous motor belt pulley drive system is used. The device is capable of handling air at max.40°C.

Fan Structure

Fan blades are produced in aerodynamic structure to provide backward curved and regular flow. It is fan welded and electrostatic powder coated.

Benefits

It responds to performance and efficiency with high flow rate and pressure channel systems. The stiff body allows the fan rotor to rotate at high speeds to achieve the desired pressure and flow rates. It prevents the accumulation of foreign materials such as dust and dirt on its sparsely wings. They provide maximum efficiency with low energy.

*Filtered applications are optional. Please contact BVN representatives.

**Motor outside the airstream options are available.

It is acoustically insulated against sound and it has the feature of vibration-free operation. Thanks to the service cover in the construction, it provides easy intervention to maintenance and faults. Prevents unnecessary pressure losses due to the option of selecting the direction of air blowing and suction nozzles.

Speed Control

Optional control devices can be provided. In the belt pulley system, speed control can be done by changing the conversion rate or frequency inverter in 3 ~ phase products. (see BSC-F accessory)

Usage Areas

It is used to exhaust fine particulate powders or contaminated air with low oil vapor concentration due to the fact that it is curved with backward curves. It is used as an fan in ducted systems with high pressure losses. It must be used with the filter in the exhaust vent.

Technical Drawing and Tables

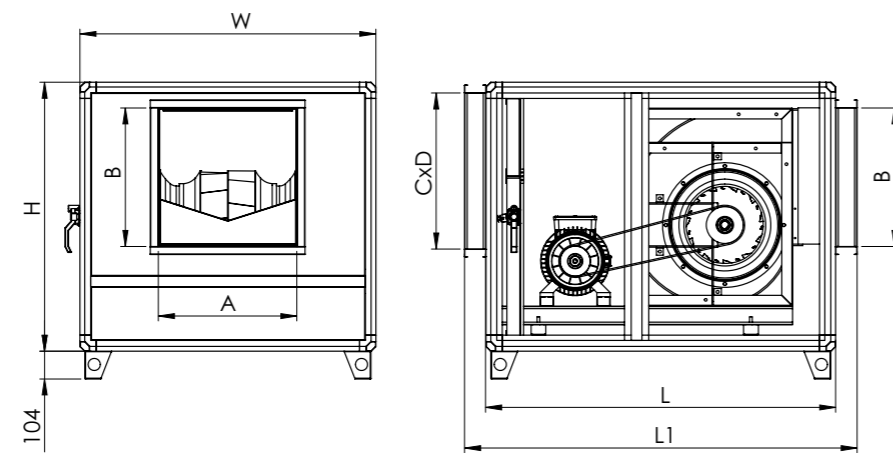

TYPE	L	W	H	L1	A	B	C	D
BHV-R 280	1050	750	750	1250	361	361	670	350
BHV-R 315	1100	850	850	1300	405	405	770	400
BHV-R 355	1200	900	900	1400	455	455	820	500
BHV-R 400	1300	1100	1000	1460	510	510	1020	580
BHV-R 450	1400	1200	1100	1560	570	570	1120	650
BHV-R 500	1600	1350	1200	1720	640	640	1235	680
BHV-R 560	1700	1500	1300	1820	715	715	1385	875
BHV-R 630	1950	1650	1650	2070	843	843	1535	965

Dimensions are in (mm)

TYPE	VOLTAGE	FREQUENCY	POWER	SPEED	AIR FLOW	PRESSURE	SOUND PRESSURE
	V	Hz	kW	d/d	m ³ /h	Pa	dB(A)
BHV-R 280-0,55	220/380	50	0,55	1920	2000	500	65
BHV-R 280-0,75	220/380	50	0,75	2200	2500	620	66
BHV-R 280-1,1	220/380	50	1,1	2400	3000	700	70
BHV-R 315-1,5	220/380	50	1,5	2250	4000	800	68
BHV-R 315-2,2	220/380	50	2,2	2550	5000	1000	70
BHV-R 315-3	220/380	50	3	2680	6000	1000	71
BHV-R 355-2,2	220/380	50	2,2	2100	5000	900	66
BHV-R 355-3	220/380	50	3	2300	6500	1000	70
BHV-R 355-4	220/380	50	4	2450	8000	1000	73
BHV-R 400-3	220/380	50	3	1950	6000	1000	69
BHV-R 400-4	380	50	4	2030	8500	1000	73
BHV-R 400-5,5	380	50	5,5	2250	11500	1000	78
BHV-R 450-3	220/380	50	3	1650	7000	900	69
BHV-R 450-4	380	50	4	1750	9000	1000	71
BHV-R 450-5,5	380	50	5,5	1870	12000	1000	75
BHV-R 500-4	380	50	4	1480	10000	1000	71
BHV-R 500-5,5	380	50	5,5	1610	13000	1000	74
BHV-R 500-7,5	380	50	7,5	1670	15000	1000	76
BHV-R 560-5,5	380	50	5,5	1380	12000	1000	65
BHV-R 560-7,5	380	50	7,5	1400	16000	1000	67
BHV-R 560-11	380	50	11	1550	22000	1000	70
BHV-R 630-11	380	50	11	1340	25000	1000	99
BHV-R 630-15	380	50	15	1450	30000	1000	102
BHV-R 630-18,5	380	50	18,5	1570	35000	1000	105

Sound Level Measured from 3m distance in room condition.

VENTILATION UNIT INLET-OUTLET DIRECTION

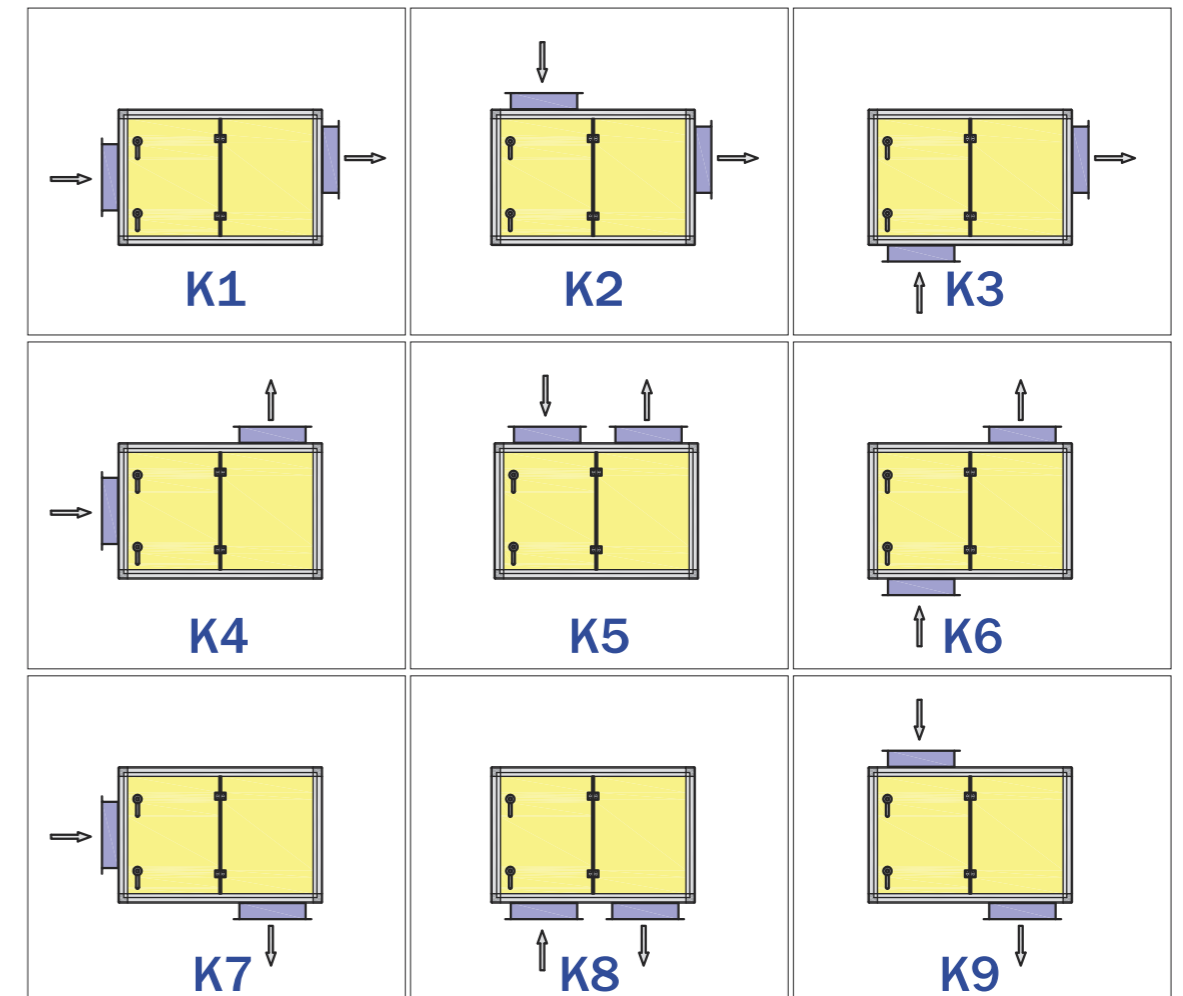

MAINTENANCE DOOR POSITION

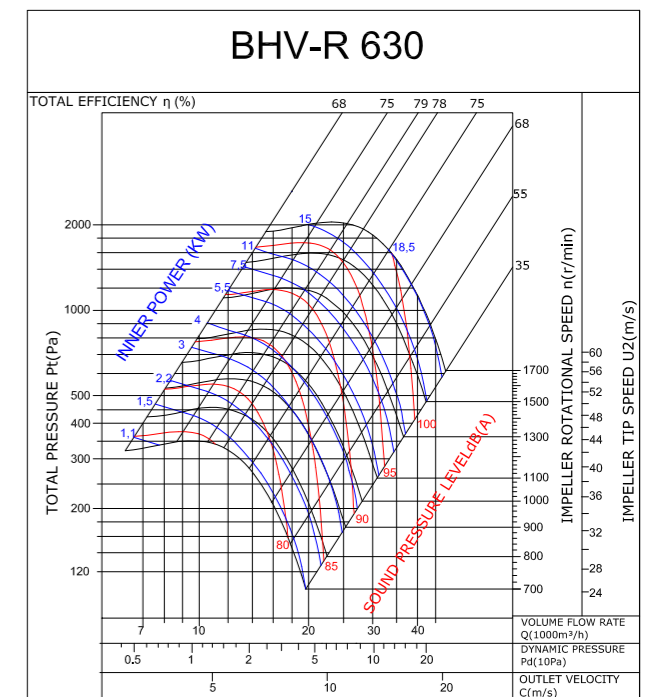
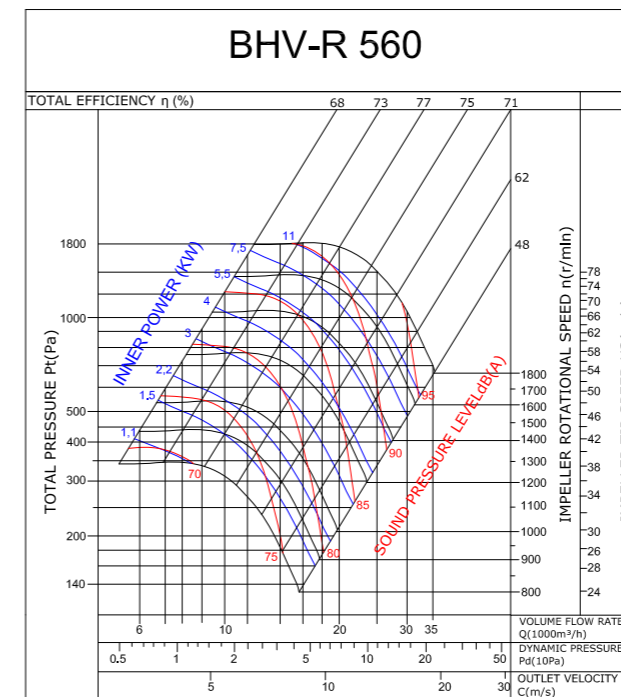
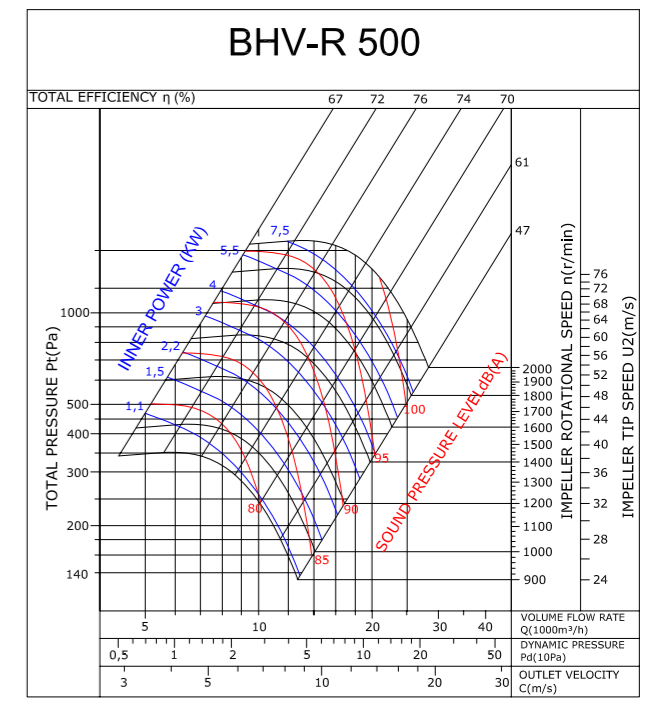
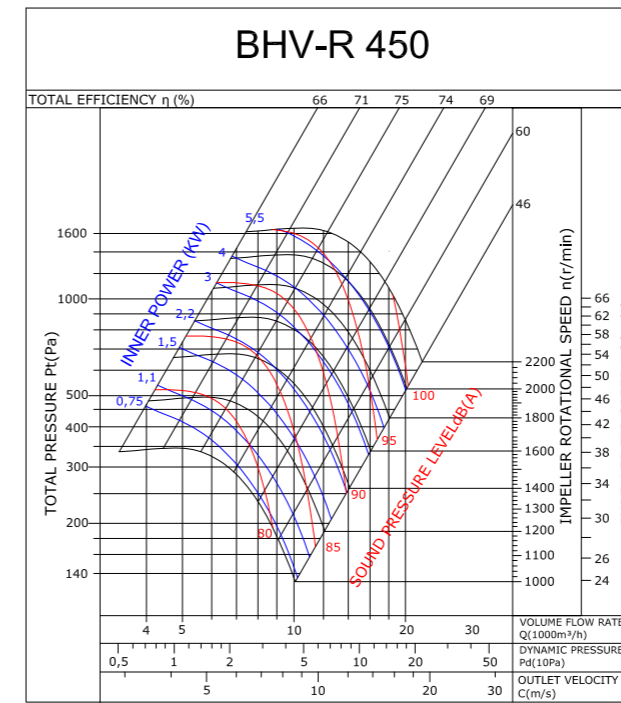
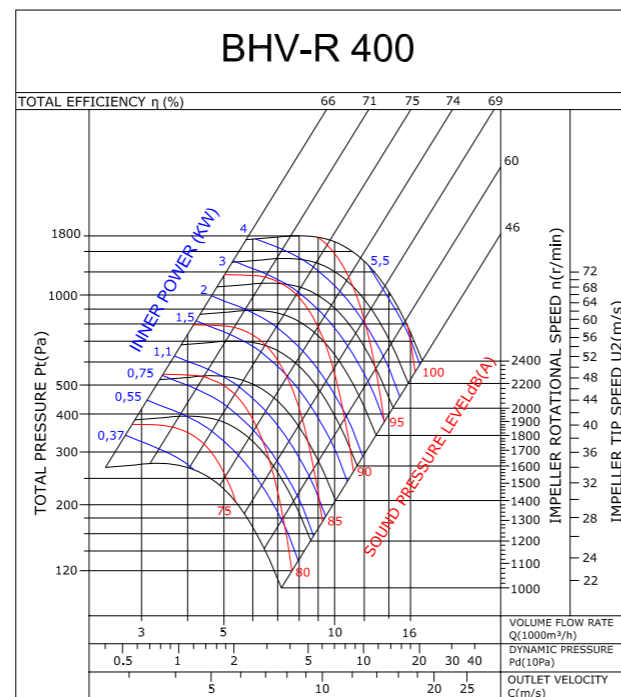
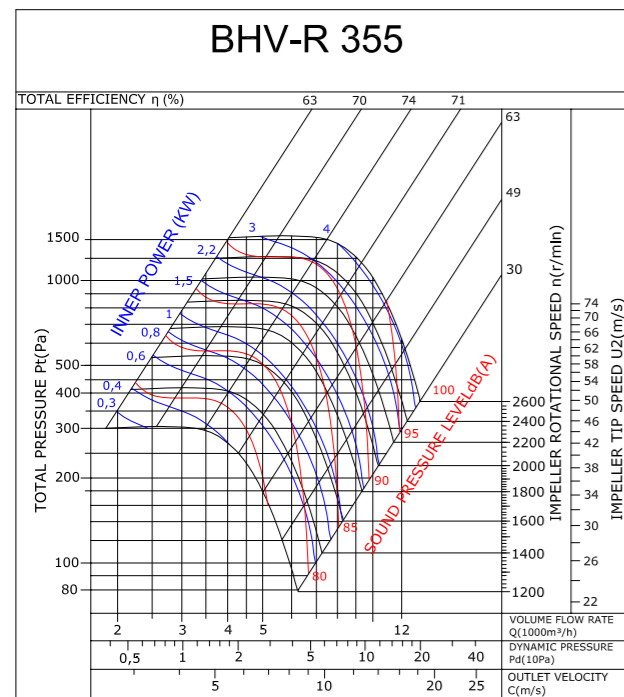
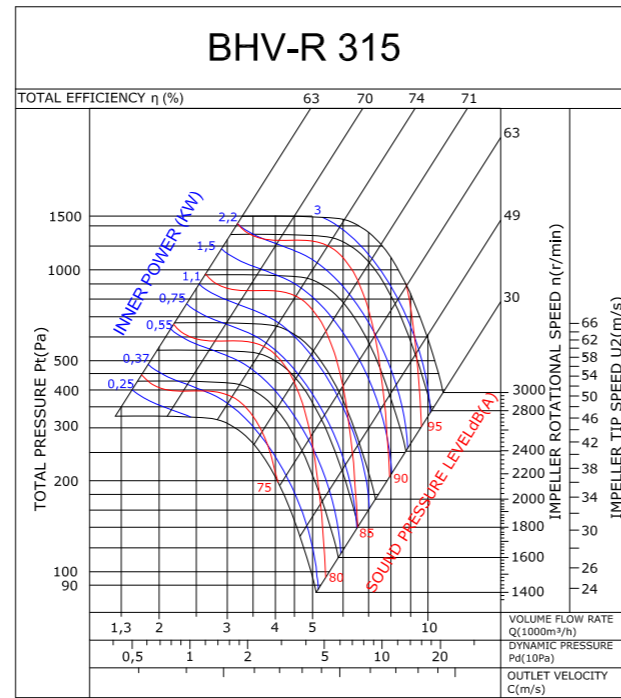
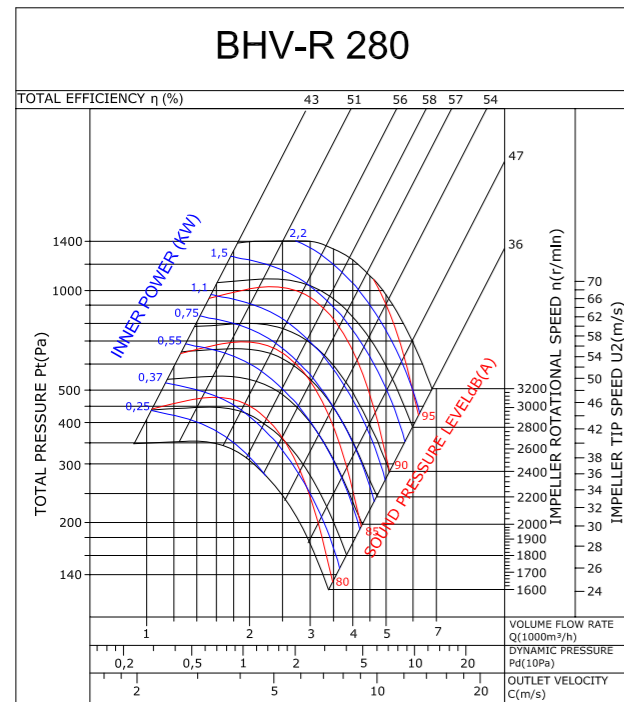
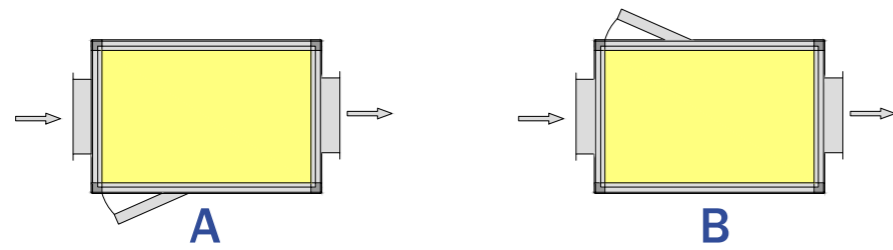



BHV-P

CABINET FANS / METALIC FILTER / Backward Curved - Plug

Fan Components and Material Properties

BHV-P single suction plug fan is made of steel sheet with electrostatic paint against corrosion. 25 mm stone wool was placed between the panels. Carcass structure is made of aluminum profile. Suitable for operation at high temperatures when the motor is out of airflow.

Fan Structure

Fan blades are produced in aerodynamic structure to provide backward curved and regular flow. It is fan welded and electrostatic powder coated.

Benefits

It responds to performance and efficiency with high flow rate and pressure channel systems. The stiff body allows the fan rotor to rotate at high speeds to achieve the desired pressure and flow rates. It prevents the accumulation of foreign materials such as dust and dirt on its sparsely wings.

They provide maximum efficiency with low energy. It is acoustically insulated against sound and it has the feature of vibration-free operation. Thanks to the service cover in the construction, it provides easy intervention to maintenance and faults. It is suitable for use in oily environments due to its standard metal filter.

Speed Control

Optional control devices can be provided. Speed control can be done with frequency inverter in 3 ~ phase products. (see BSC-F accessory)

Usage Areas

It is used for exhausting dirty air with fine particulate powders or high oil mist concentration due to its sloped sparse blades. It is used as an fan in ducted systems with high pressure losses.

Technical Drawing and Tables

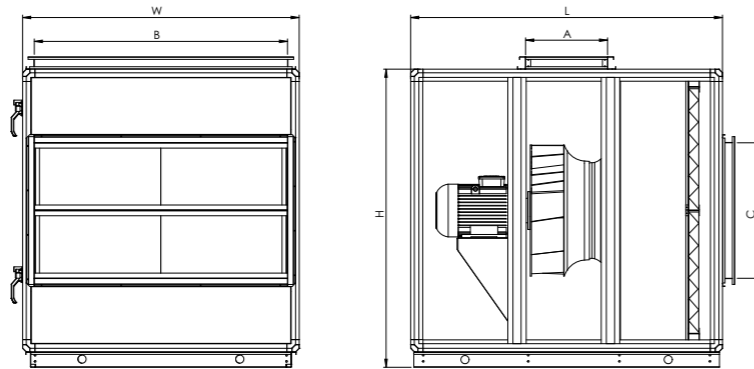

TYPE	H	W	L	A	B	C
BHV-P 315-0,37/4	800	725	1000	250	610	350
BHV-P 315-1,5/2	800	1035	1000	250	920	350
BHV-P 355-0,55/4	800	725	1060	300	610	350
BHV-P 355-3/2	1110	1035	1200	300	920	450
BHV-P 400-0,75/4	800	1035	1120	320	920	350
BHV-P 400-5,5/2	1110	1300	1270	320	1190	450
BHV-P 450-1,1/4	1110	1035	1220	350	920	450
BHV-P 450-7,5/2	1375	1300	1400	350	1190	550
BHV-P 500-3/4	1110	1300	1270	400	1190	450
BHV-P 560-4/4	1375	1300	1400	400	1190	550
BHV-P 630-5,5/4	1375	1610	1600	450	1190	660

Dimensions are in (mm)

TYPE	VOLTAGE	FREQUENCY	POWER	MOTOR SPEED	AIR FLOW	EXTERNAL PRESSURE LOSS
	V	Hz	kW	r.p.m	m ³ /h	Pa
BHV-P 315-0,37/4	230-380	50	0,37	1450	2600	100
BHV-P 315-1,5/2	230-380	50	1,5	2800	5000	400
BHV-P 355-0,55/4	230-380	50	0,55	1450	3400	100
BHV-P 355-3/2	380	50	3	2800	7500	500
BHV-P 400-0,75/4	230-380	50	0,75	1450	6000	100
BHV-P 400-5,5/2	230-380	50	5,5	2800	11000	500
BHV-P 450-1,1/4	230-380	50	1,1	1450	8000	200
BHV-P 450-7,5/2	380	50	7,5	2800	15000	600
BHV-P 500-3/4	380	50	3	1450	11000	200
BHV-P 560-4/4	380	50	4	1450	15000	250
BHV-P 630-5,5/4	380	50	5,5	1450	21000	300

Sound Level Measured from 3m distance in room condition.

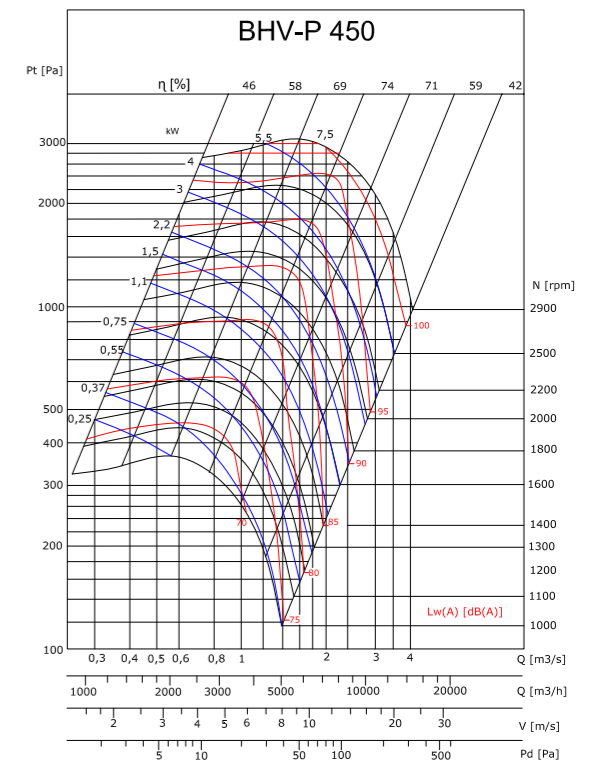
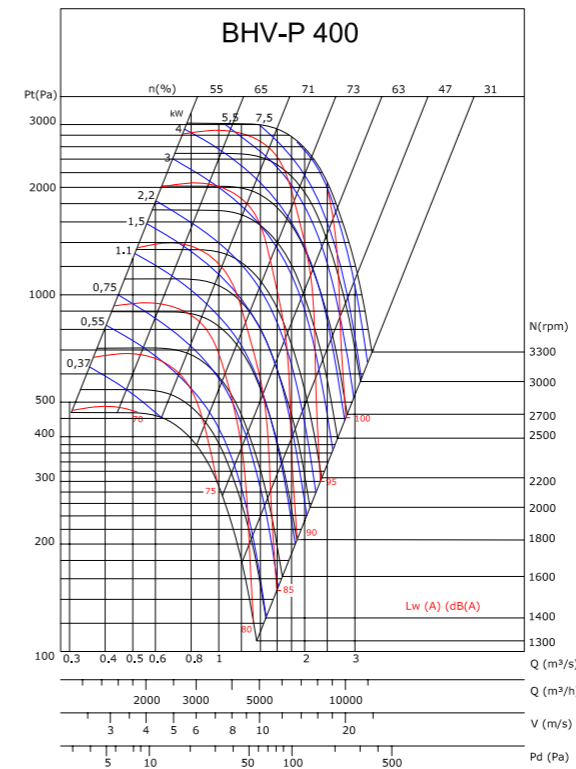
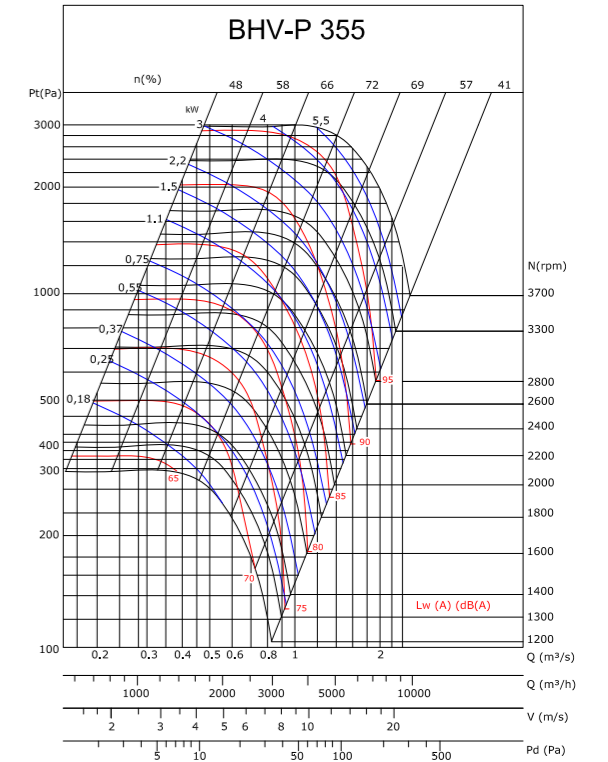
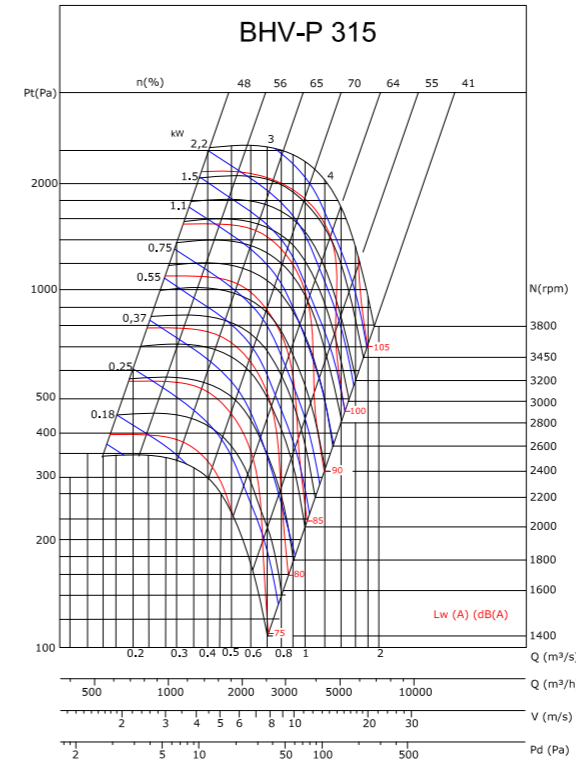

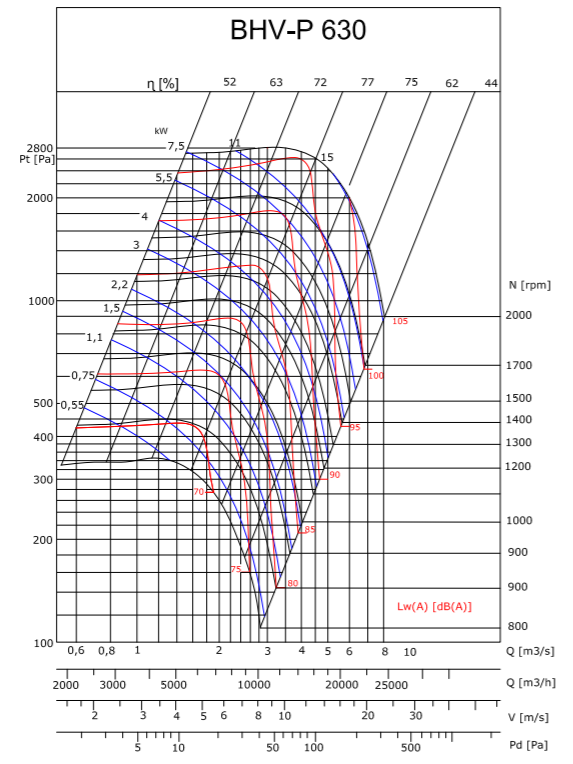
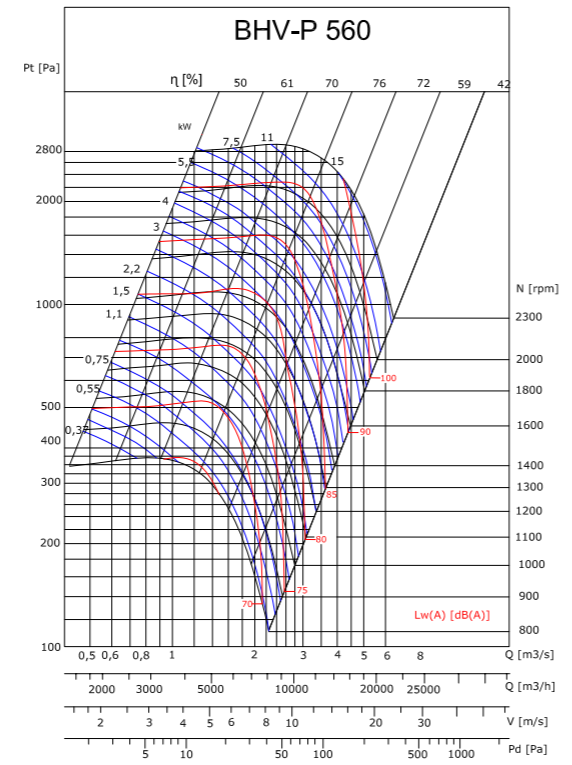
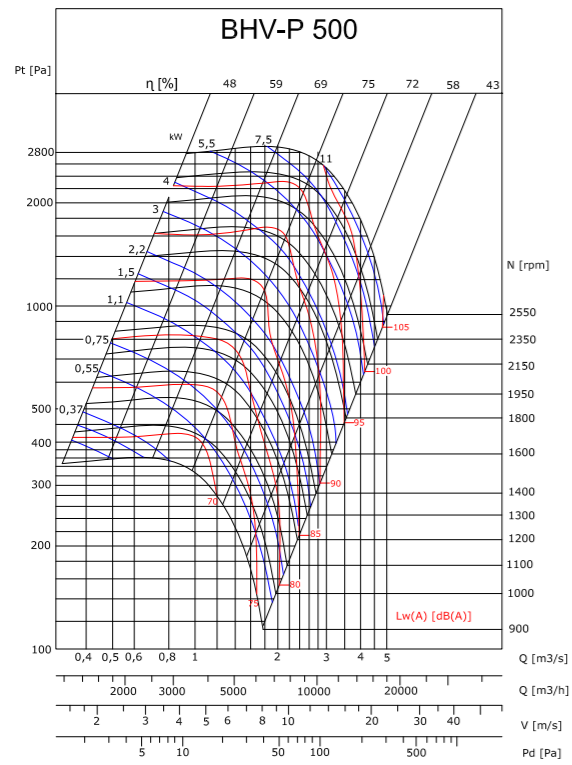

Accessories



ARMO-C

CABINET FANS / Axial

Box Axial fans are used in pressurization fan, fresh air fan and smoke exhaust fan applications. The box is fire resistant and designed according to the noise standard. Smoke evacuation fans are fire resistant.

General Features

- It has EN 12101-3 and Ce certificates. • 2 hours continuous operation at 400 C and 300C • There is a wide product range from 400 mm to 1250 mm.

Rotor Features

- Fire resistant aluminum alloy casting blades and fan hub. • has the ability to work one-way and two-way. The blades are specially designed according to each direction type. • There is no aerodynamic loss in the case of reversible wing type operation. • Wings are airfoil and provide high aerodynamic performance in both unidirectional and bidirectional vanes. • Wing angles are adjustable. In this way, smoke discharge fans can be demanded at different flow rates and pressures.

- The fan part of the fan is dynamically balanced according to ISO 1940 and there is no eccentricity during the operation of the fan.

Body Features

- Fan body is steel sheet. Body is hot dip galvanized and corrosion resistant. • It has short type body and long type body types.

Motor Features

- Offers 2.4 and 6-pole motors
- The motors are IP 55 class and Class-H insulated.
- All electric motor models are approved for continuous operation (S1) and Emergency operation (S2).

Ease of Maintenance

A maintenance cover is provided to ensure easy maintenance.

Usage Areas

Stair pressurization fan, fresh air fan, smoke is used as exhaust fan.

Technical Drawing and Tables

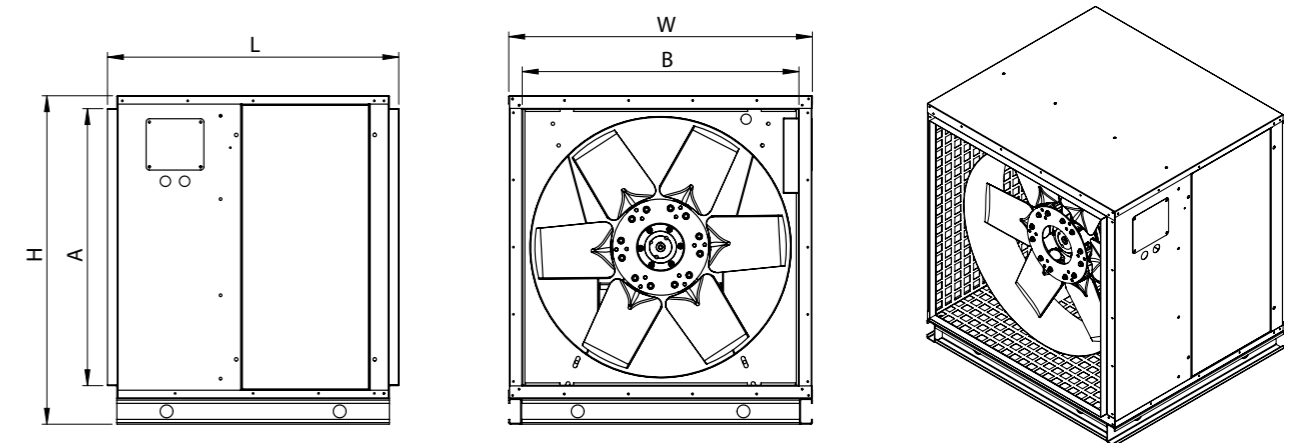

TYPE	L	W	H	A	B
ARMO-C 400	592	568	640	490	490
ARMO-C 450	592	568	640	490	490
ARMO-C 500	592	620	686	536	536
ARMO-C 560	745	707	775	624	624
ARMO-C 630	745	777	845	694	694
ARMO-C 710	910	857	925	774	774
ARMO-C 800	910	950	1025	865	865
ARMO-C 900	1065	1050	1125	965	965
ARMO-C 1000	1065	1150	1250	1069	1069
ARMO-C 1250	1065	1400	1500	1319	1319

Dimensions are in (mm)



2 POLE						
TYPE	SPEED	DIAMETER	POWER	CURRENT	AIR FLOW	WING ANGLE
	r.p.m	mm	kW	A	m ³ /h	
ARMO-C / 400-6 / 0,75 - 2A	2900	400	0,75	1,6	5250	16°
ARMO-C / 400-6 / 1,1 - 2A	2900	400	1,1	2,3	6904	22°
ARMO-C / 400-6 / 1,5 - 2A	2900	400	1,5	3,4	8978	30°
ARMO-C / 400-6 / 2,2 - 2A	2900	400	2,2	4,48	9975	34°
ARMO-C / 450-6 / 1,1 - 2A	2900	450	1,1	2,3	6248	10°
ARMO-C / 450-6 / 1,5 - 2A	2900	450	1,5	3,4	8610	16°
ARMO-C / 450-6 / 2,2 - 2A	2900	450	2,2	4,48	11970	24°
ARMO-C / 450-6 / 3 - 2A	2900	450	3	6	13545	28°
ARMO-C / 500-6 / 2,2 - 2A	2900	500	2,2	4,48	11000	14°
ARMO-C / 500-6 / 3 - 2A	2900	500	3	6	14595	20°
ARMO-C / 500-6 / 4 - 2A	2900	500	4	7,4	17325	26°
ARMO-C / 500-6 / 5,5 - 2A	2900	500	5,5	11	18375	28°
ARMO-C / 560-6 / 4 - 2A	2900	560	4	7,4	17850	14°
ARMO-C / 560-6 / 5,5 - 2A	2900	560	5,5	11	22313	20°
ARMO-C / 560-6 / 7,5 - 2A	2800	560	7,5	13,6	25725	24°
ARMO-C / 630-6 / 5,5 - 2A	2900	630	5,5	11	20475	10°
ARMO-C / 630-6 / 7,5 - 2A	2800	630	7,5	13,6	27300	16°

4 POLE						
TYPE	SPEED	DIAMETER	POWER	CURRENT	AIR FLOW	WING ANGLE
	r.p.m	mm	kW	A	m ³ /h	
ARMO-C / 500-6 / 0,55 - 4A	1415	500	0,55	1,6	8715	26
ARMO-C / 500-6 / 0,75 - 4A	1350	500	0,75	2,1	10290	32
ARMO-C / 500-6 / 1,1 - 4A	1400	500	1,1	2,6	12600	38
ARMO-C / 560-6 / 0,55 - 4A	1415	560	0,55	1,6	9870	16
ARMO-C / 560-6 / 0,75 - 4A	1350	560	0,75	2,1	12075	22
ARMO-C / 560-6 / 1,1 - 4A	1400	560	1,1	2,6	13860	26
ARMO-C / 560-6 / 1,5 - 4A	1405	560	1,5	3,5	15750	32
ARMO-C / 560-6 / 2,2 - 4A	1410	560	2,2	5	17850	38
ARMO-C / 630-6 / 0,75 - 4A	1350	630	0,75	2,1	10605	10
ARMO-C / 630-6 / 1,1 - 4A	1400	630	1,1	2,6	16275	20
ARMO-C / 630-6 / 1,5 - 4A	1405	630	1,5	3,5	18375	24
ARMO-C / 630-6 / 2,2 - 4A	1410	630	2,2	5	21525	30
ARMO-C / 630-6 / 3 - 4A	1410	630	3	6,6	24150	36
ARMO-C / 630-6 / 4 - 4A	1500	630	4	8,2	25200	38
ARMO-C / 710-3 / 0,75 - 4A	1350	710	0,75	2,1	14175	10
ARMO-C / 710-3 / 1,1 - 4A	1400	710	1,1	2,6	18375	16
ARMO-C / 710-3 / 1,5 - 4A	1405	710	1,5	3,5	21000	20
ARMO-C / 710-3 / 2,2 - 4A	1410	710	2,2	5	24413	26
ARMO-C / 710-3 / 3 - 4A	1410	710	3	6,6	27825	32
ARMO-C / 710-6 / 1,1 - 4A	1400	710	1,1	2,6	16275	12
ARMO-C / 710-6 / 1,5 - 4A	1405	710	1,5	3,5	20475	18
ARMO-C / 710-6 / 2,2 - 4A	1410	710	2,2	5	23625	22
ARMO-C / 710-6 / 3 - 4A	1410	710	3	6,6	28350	28
ARMO-C / 710-6 / 4 - 4A	1415	710	4	8,2	31500	32
ARMO-C / 800-6 / 2,2 - 4A	1410	800	2,2	5	24150	14
ARMO-C / 800-6 / 3 - 4A	1410	800	3	6,6	30450	20
ARMO-C / 800-6 / 4 - 4A	1415	800	4	8,2	32550	22
ARMO-C / 800-6 / 5,5 - 4A	1430	800	5,5	11,2	38850	28
ARMO-C / 800-6 / 7,5 - 4A	1440	800	7,5	15,4	42525	32
ARMO-C / 800-9 / 2,2 - 4A	1410	800	2,2	5	16275	10
ARMO-C / 800-9 / 3 - 4A	1410	800	3	6,6	21525	14
ARMO-C / 800-9 / 4 - 4A	1415	800	4	8,2	29400	20
ARMO-C / 800-9 / 5,5 - 4A	1430	800	5,5	11,2	36488	26
ARMO-C / 800-9 / 7,5 - 4A	1440	800	7,5	15,4	40950	30
ARMO-C / 800-9 / 11 - 4A	1450	800	11	21	43050	32
ARMO-C / 900-6 / 4 - 4A	1415	900	4	8,2	31500	12
ARMO-C / 900-6 / 5,5 - 4A	1430	900	5,5	11,2	38850	16
ARMO-C / 900-6 / 7,5 - 4A	1440	900	7,5	15,4	47775	22
ARMO-C / 900-6 / 11 - 4A	1450	900	11	21	56700	28
ARMO-C / 900-6 / 15 - 4A	1450	900	15	29,3	60900	32
ARMO-C / 900-9 / 4 - 4A	1415	900	4	8,2	26775	10
ARMO-C / 900-9 / 5,5 - 4A	1430	900	5,5	11,2	34125	14
ARMO-C / 900-9 / 7,5 - 4A	1440	900	7,5	15,4	41213	18
ARMO-C / 900-9 / 11 - 4A	1450	900	11	21	54600	26
ARMO-C / 900-9 / 15 - 4A	1450	900	15	29,3	63525	32
ARMO-C / 1000-6 / 5,5 - 4A	1430	1000	5,5	11,2	38850	12
ARMO-C / 1000-6 / 7,5 - 4A	1440	1000	7,5	15,4	47775	18
ARMO-C / 1000-6 / 11 - 4A	1450	1000	11	21	56700	22
ARMO-C / 1000-6 / 15 - 4A	1450	1000	15	29,3	60900	28
ARMO-C / 1000-6 / 18,5 - 4A	1455	1000	18,5	34,5	56700	32
ARMO-C / 1000-9 / 7,5 - 4A	1440	1000	7,5	15,4	43050	12
ARMO-C / 1000-9 / 11 - 4A	1450	1000	11	21	55650	18
ARMO-C / 1000-9 / 15 - 4A	1450	1000	15	29,3	69300	24
ARMO-C / 1000-9 / 18,5 - 4A	1455	1000	18,5	34,5	77700	28
ARMO-C / 1000-9 / 22 - 4A	1460	1000	22	42,5	81900	30
ARMO-C / 1000-9 / 30 - 4A	1460	1000	30	55	86100	32
ARMO-C / 1250-6 / 15 - 4A	1450	1250	15	29,3	90300	12
ARMO-C / 1250-6 / 18,5 - 4A	1455	1250	18,5	34,5	103950	16
ARMO-C / 1250-6 / 22 - 4A	1460	1250	22	42,5	109725	18
ARMO-C / 1250-6 / 30 - 4A	1460	1250	30	55	122850	22
ARMO-C / 1250-6 / 37 - 4A	1470	1250	37	67	136500	26
ARMO-C / 1250-6 / 45 - 4A	1475	1250	45	80	155400	32
ARMO-C / 1250-9 / 18,5 - 4A	1455	1250	18,5	34,5	89250	12
ARMO-C / 1250-9 / 22 - 4A	1460	1250	22	42,5	97650	14
ARMO-C / 1250-9 / 30 - 4A	1460	1250	30	55	114975	18
ARMO-C / 1250-9 / 37 - 4A	1470	1250	37	67	131250	22
ARMO-C / 1250-9 / 45 - 4A	1475	1250	45	80	138600	24

6 POLE						
TYPE	SPEED	DIAMETER	POWER	CURRENT	AIR FLOW	WING ANGLE
	r.p.m					
ARMO-C / 500-6 / 0,37 - 6A	900	500	0,37	1,1	8400	38
ARMO-C / 560-6 / 0,37 - 6A	900	560	0,37	1,1	10500	32
ARMO-C / 560-6 / 0,55 - 6A	930	560	0,55	1,5	11760	38
ARMO-C / 630-6 / 0,37 - 6A	900	630	0,37	1,1	11576	22
ARMO-C / 630-6 / 0,55 - 6A	930	630	0,55	1,5	13650	28
ARMO-C / 630-6 / 0,75 - 6A	945	630	0,75	2	14963	32
ARMO-C / 630-6 / 1,1 - 6A	945	630	1,1	2,9	16800	38
ARMO-C / 710-3 / 0,37 - 6A	900	710	0,37	1,1	13125	18
ARMO-C / 710-3 / 0,55 - 6A	930	710	0,55	1,5	16538	26
ARMO-C / 710-3 / 0,75 - 6A	945	710	0,75	2	18900	32
ARMO-C / 710-6 / 1,1 - 6A	945	710	1,1	2,9	11025	12
ARMO-C / 710-6 / 1,5 - 6A	945	710	1,5	3,6	13000	16
ARMO-C / 710-6 / 2,2 - 6A	950	710	2,2	5,4	13750	22
ARMO-C / 710-6 / 3 - 6A	950	710	3	6,9	18900	28
ARMO-C / 710-6 / 4 - 6A	955	710	4	9	21000	32
ARMO-C / 800-6 / 0,55 - 6A	930	800	0,55	1,5	13125	10
ARMO-C / 800-6 / 1,1 - 6A	945	800	1,1	2,9	22050	22
ARMO-C / 800-6 / 1,5 - 6A	945	800	1,5	3,6	25200	26
ARMO-C / 800-6 / 2,2 - 6A	950	800	2,2	5,4	28350	32
ARMO-C / 800-9 / 0,75 - 6A	945	800	0,75	2	14700	14
ARMO-C / 800-9 / 1,1 - 6A	945	800	1,1	2,9	19950	20
ARMO-C / 800-9 / 1,5 - 6A	945	800	1,5	3,6	23100	24
ARMO-C / 800-9 / 2,2 - 6A	950	800	2,2	5,4	27300	30
ARMO-C / 800-9 / 3 - 6A	950	800	3	6,9	28350	32
ARMO-C / 900-6 / 1,1 - 6A	945	900	1,1	2,9	23100	14
ARMO-C / 900-6 / 1,5 - 6A	945	900	1,5	3,6	25200	16
ARMO-C / 900-6 / 2,2 - 6A	950	900	2,2	5,4	31500	22
ARMO-C / 900-6 / 3 - 6A	950	900	3	6,9	36750	28
ARMO-C / 900-6 / 4 - 6A	955	900	4	9	40950	32
ARMO-C / 900-9 / 1,5 - 6A	945	900	1,5	3,6	23100	14
ARMO-C / 900-9 / 2,2 - 6A	950	900	2,2	5,4	27300	20
ARMO-C / 900-9 / 3 - 6A	950	900	3	6,9	35700	24
ARMO-C / 900-9 / 4 - 6A	955	900	4	9	39900	30
ARMO-C / 900-9 / 5,5 - 6A	985	900	5,5	12,3	43050	32
ARMO-C / 1000-6 / 1,5 - 6A	945	1000	1,5	3,6	26250	10
ARMO-C / 1000-6 / 2,2 - 6A	950	1000	2,2	5,4	34650	16
ARMO-C / 1000-6 / 3 - 6A	950	1000	3	6,9	44100	22
ARMO-C / 1000-6 / 4 - 6A	955	1000	4	9	49350	26
ARMO-C / 1000-6 / 5,5 - 6A	985	1000	5,5	12,3	55650	32
ARMO-C / 1000-9 / 2,2 - 6A	950	1000	2,2	5,4	32550	14
ARMO-C / 1000-9 / 3 - 6A	950	1000	3	6,9	39900	20
ARMO-C / 1000-9 / 4 - 6A	955	1000	4	9	43050	22
ARMO-C / 1000-9 / 5,5 - 6A	985	1000	5,5	12,3	52500	28
ARMO-C / 1000-9 / 7,5 - 6A	960	1000	7,5	15	57750	32
ARMO-C / 1250-6 / 4 - 6A	955	1250	4	9	60900	12
ARMO-C / 1250-6 / 5,5 - 6A	985	1250	5,5	12,3	63300	16
ARMO-C / 1250-6 / 7,5 - 6A	960	1250	7,5	15	76650	20
ARMO-C / 1250-6 / 11 - 6A	960	1250	11	22	92400	26
ARMO-C / 1250-6 / 15 - 6A	965	1250	15	29	105000	32
ARMO-C / 1250-9 / 7,5 - 6A	960	1250	7,5	15	73500	16
ARMO-C / 1250-9 / 11 - 6A	960	1250	11	22	88200	22
ARMO-C / 1250-9 / 15 - 6A	965	1250	15	29	105000	28
ARMO-C / 1250-9 / 18,5 - 6A	970	1250	18,5	36,5	115500	32

Accessories

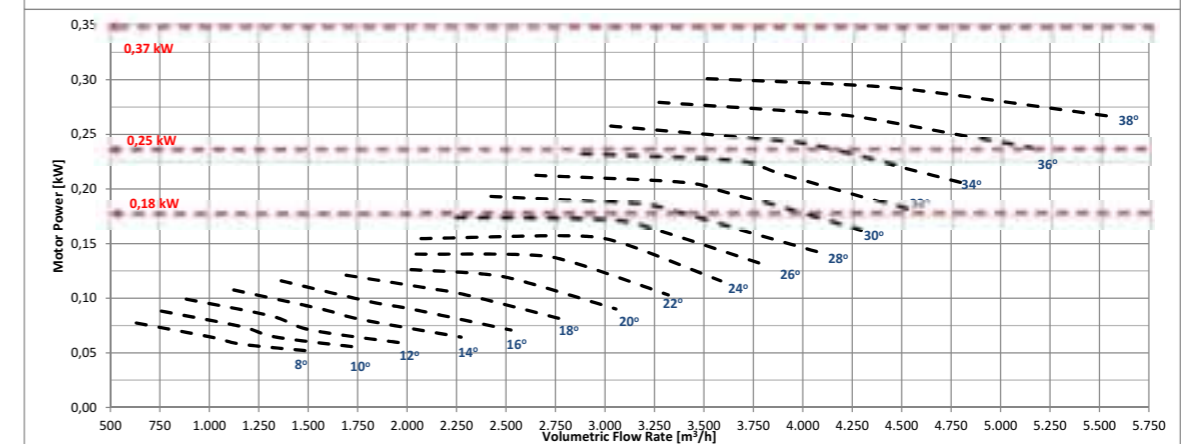
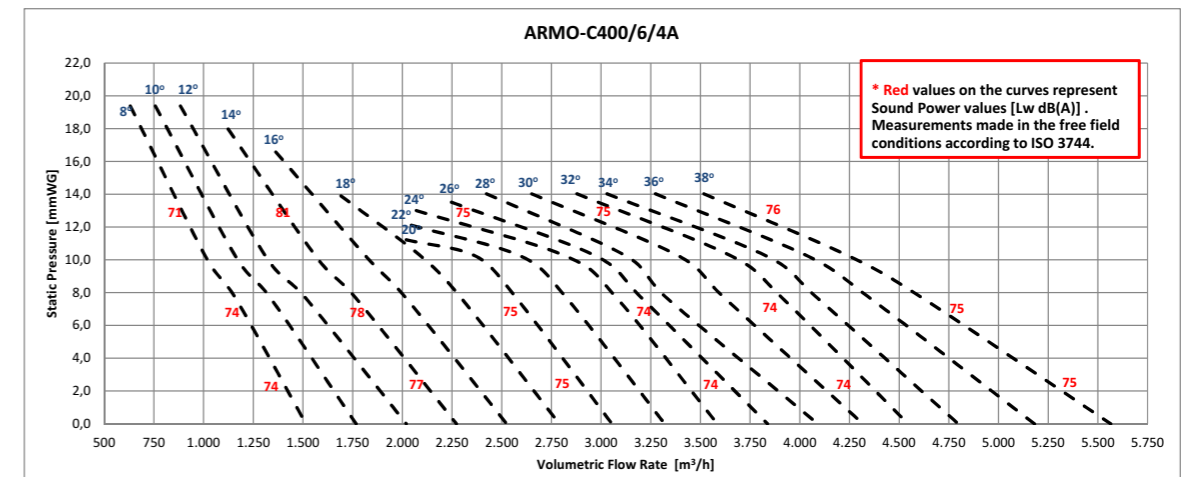
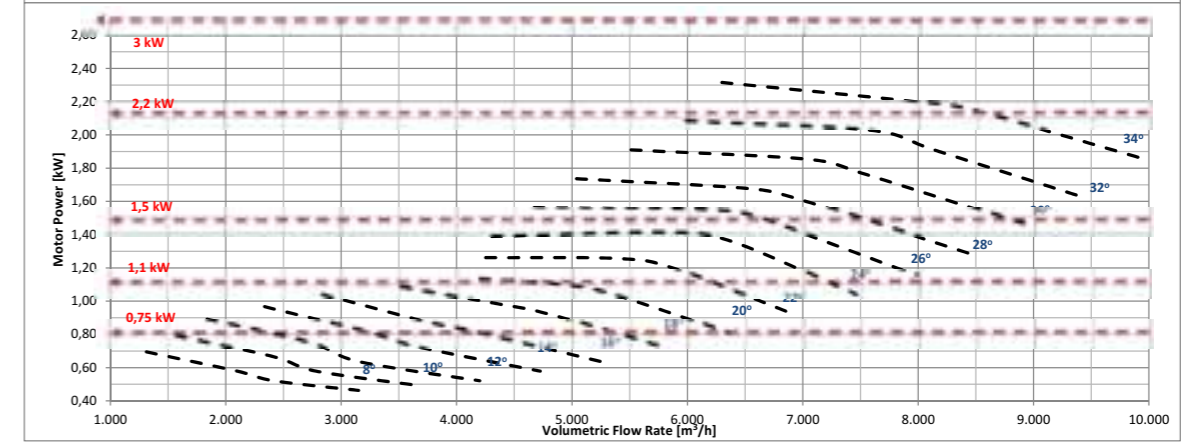
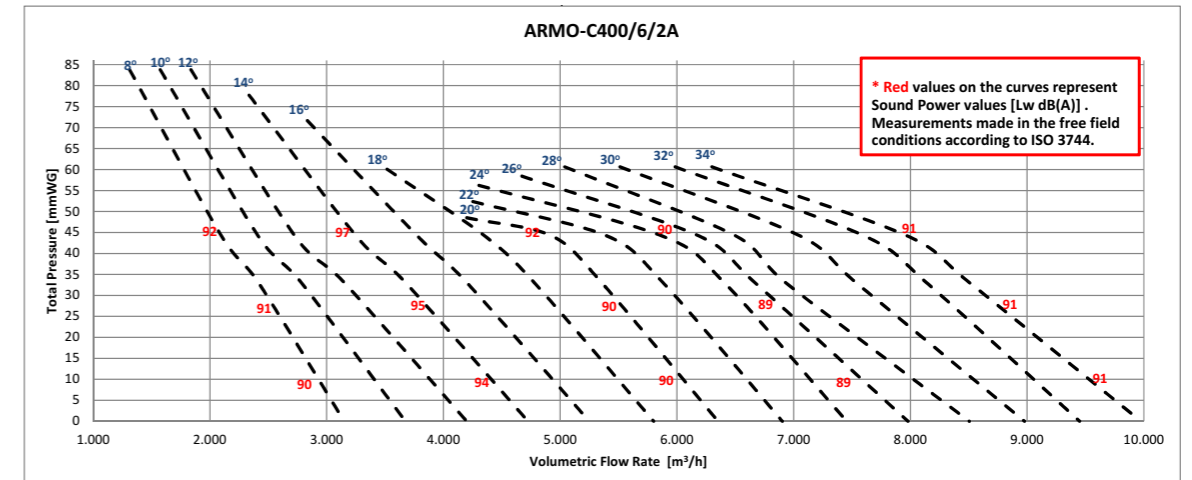

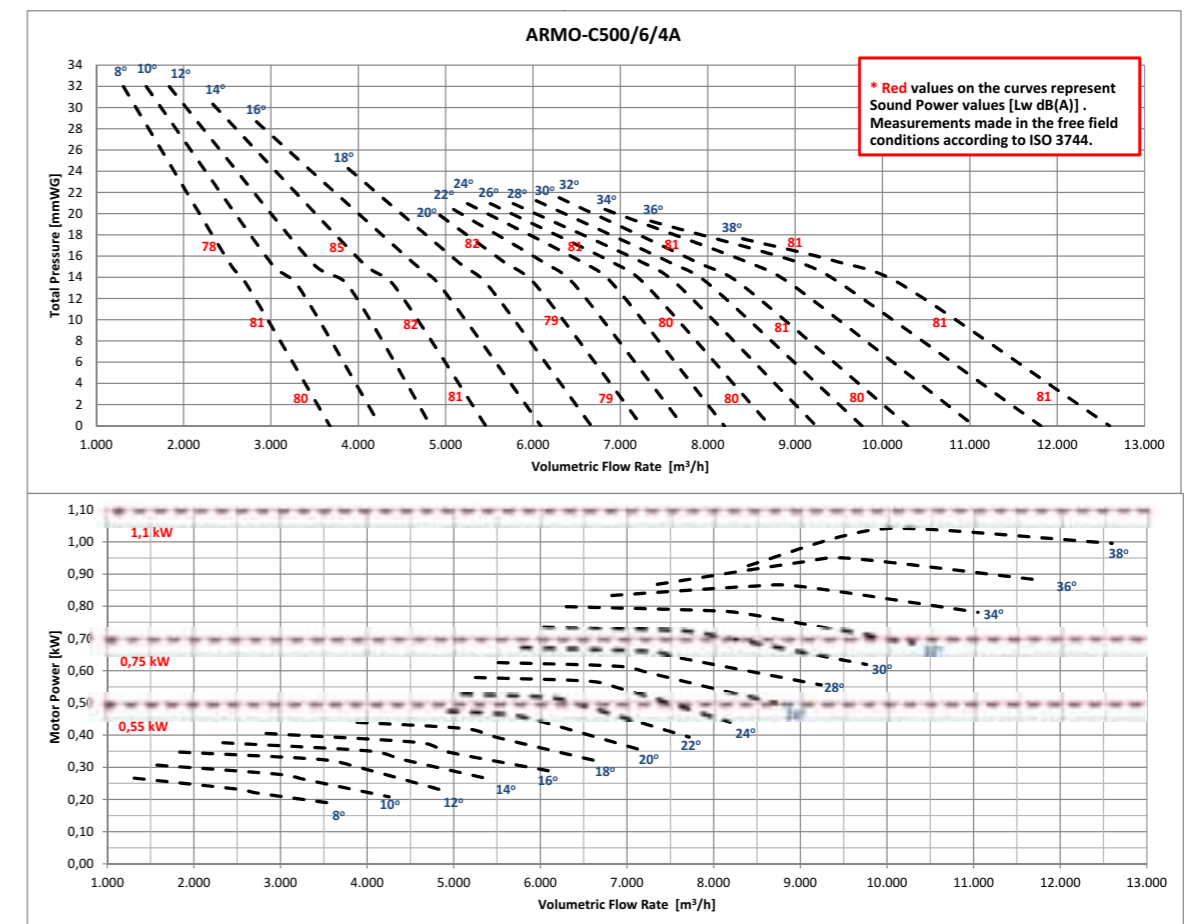
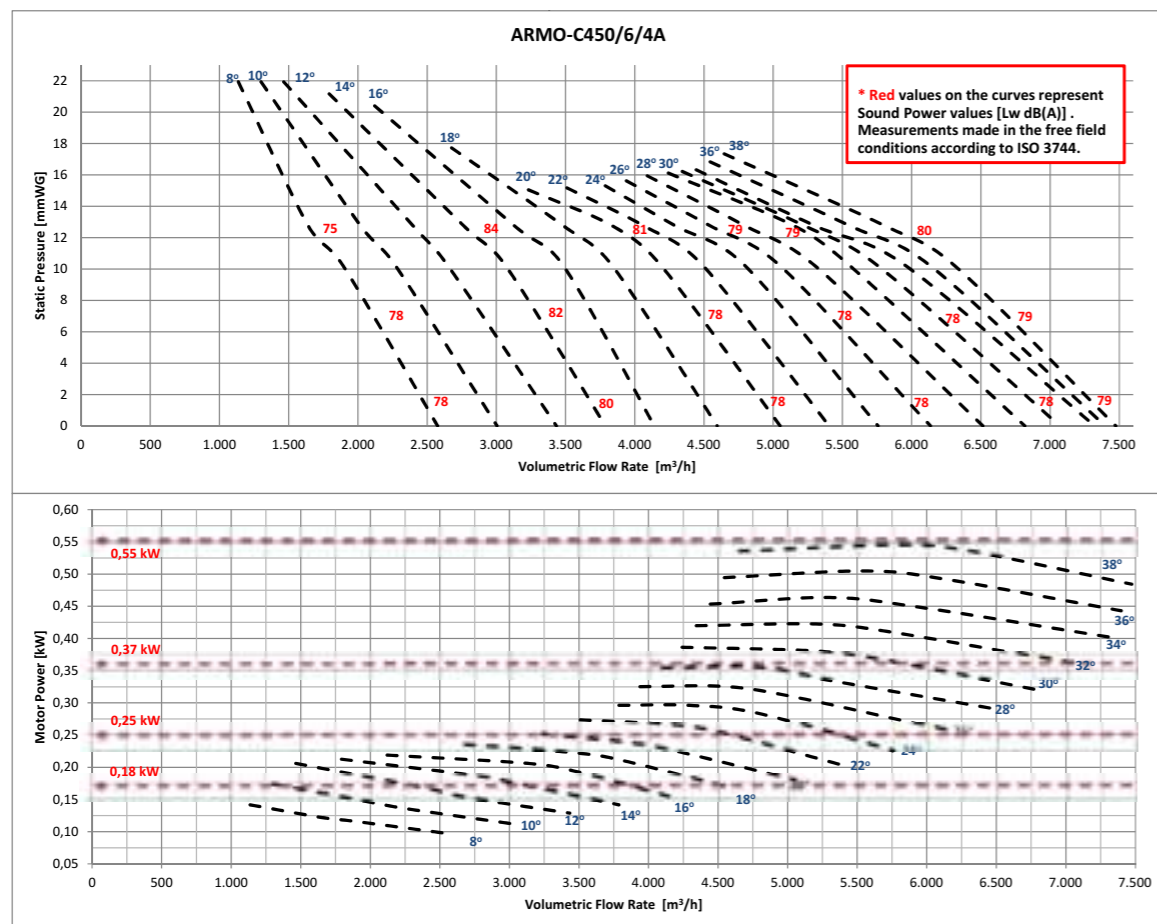
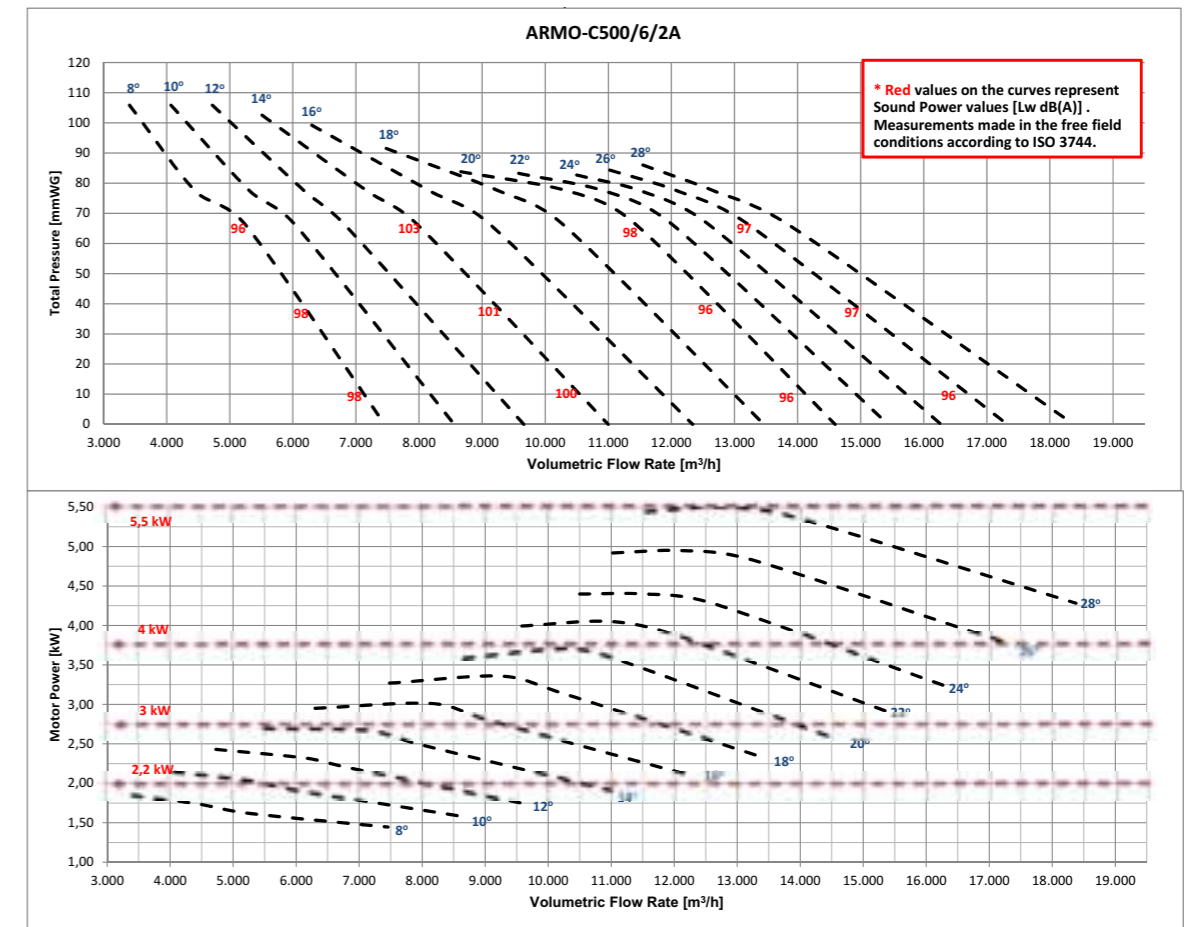
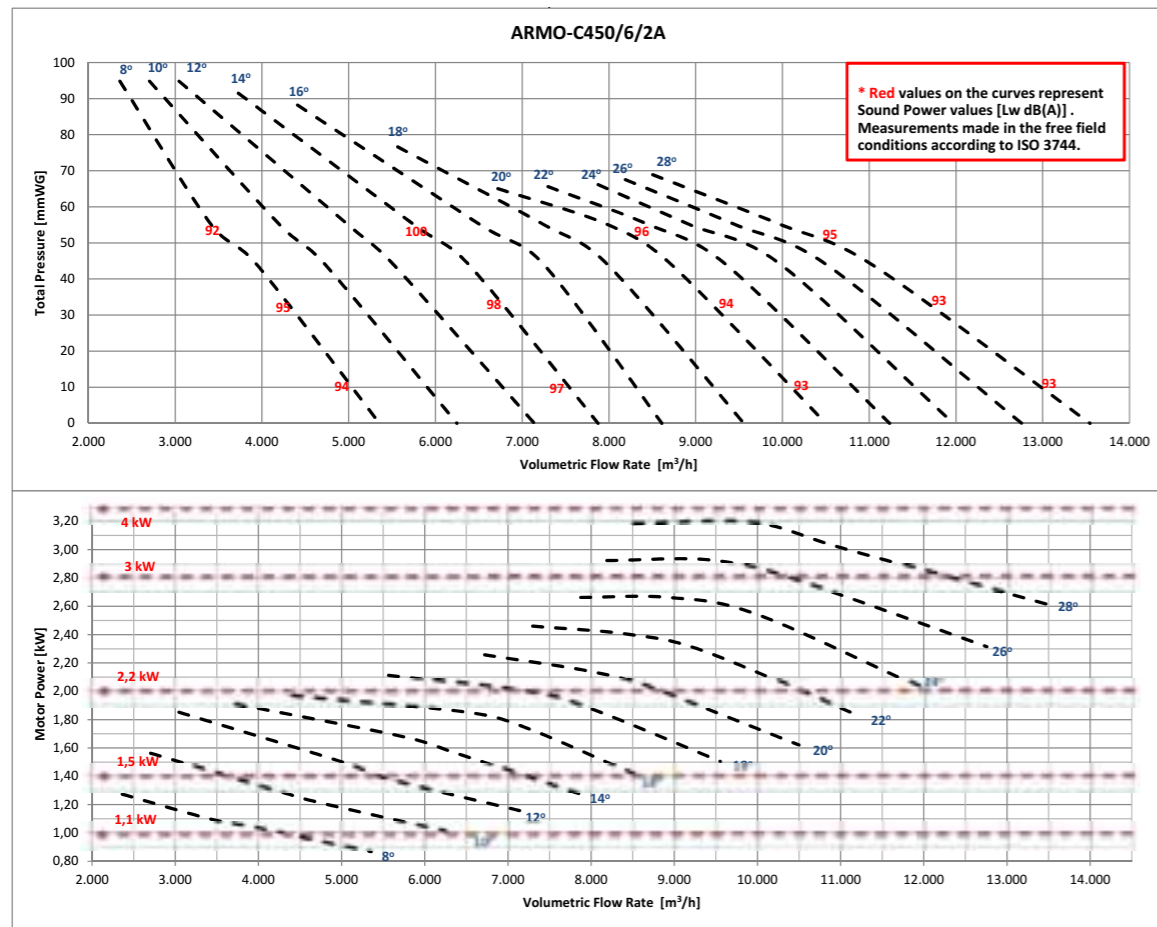

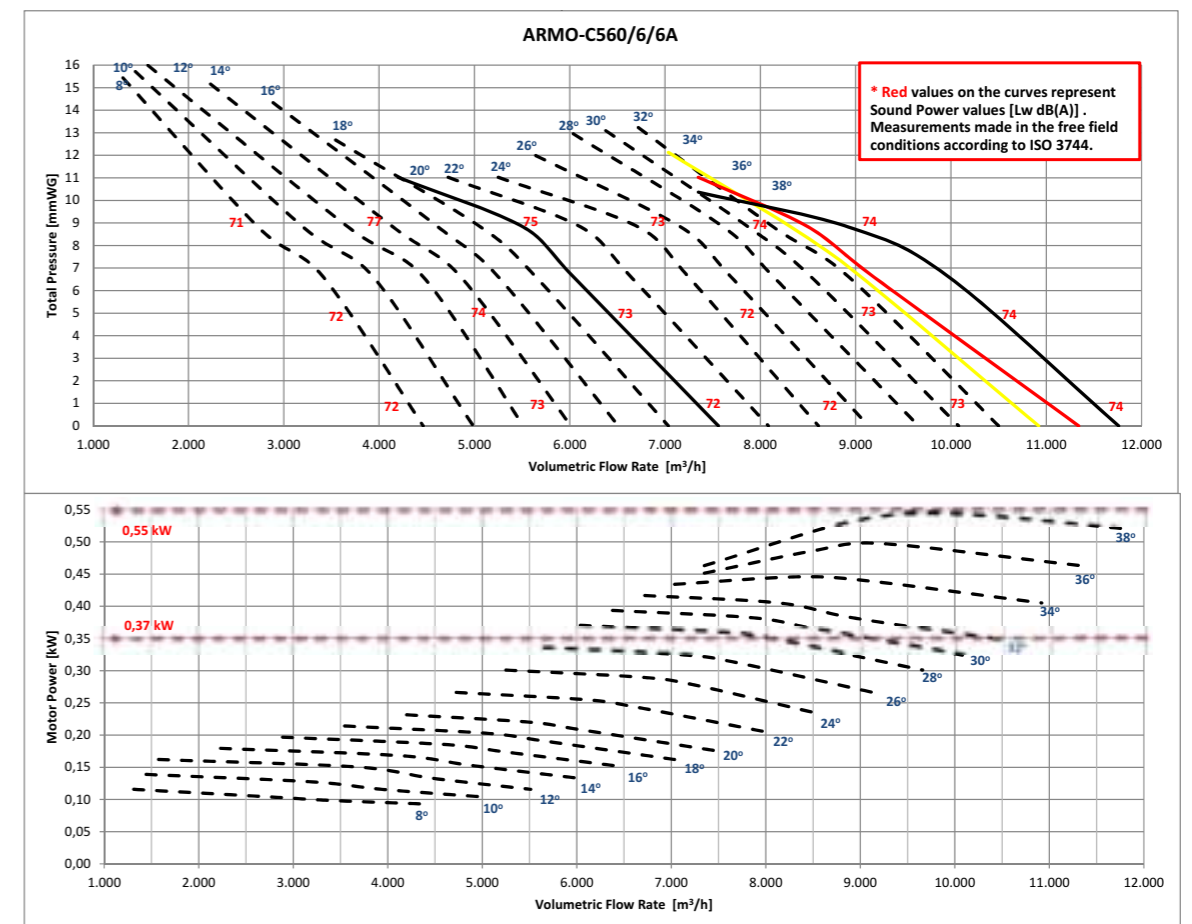
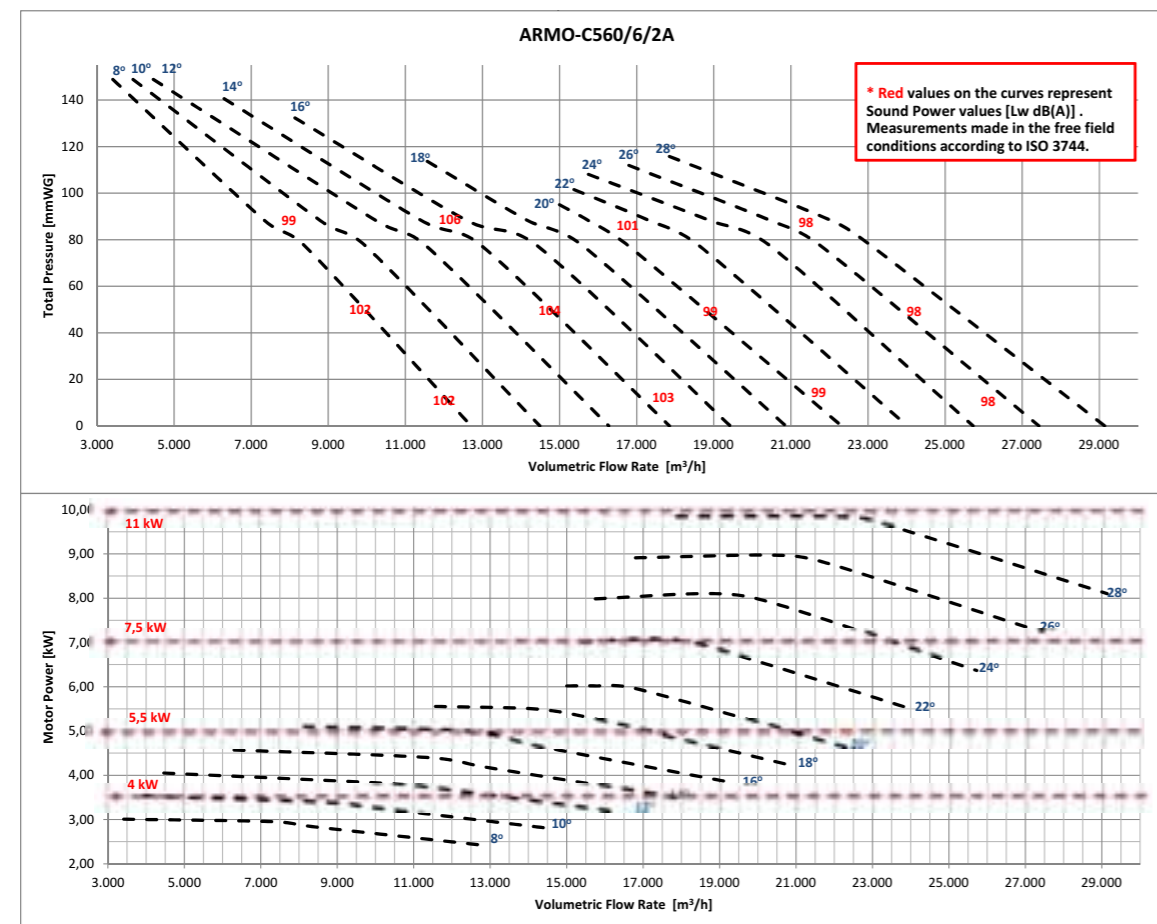
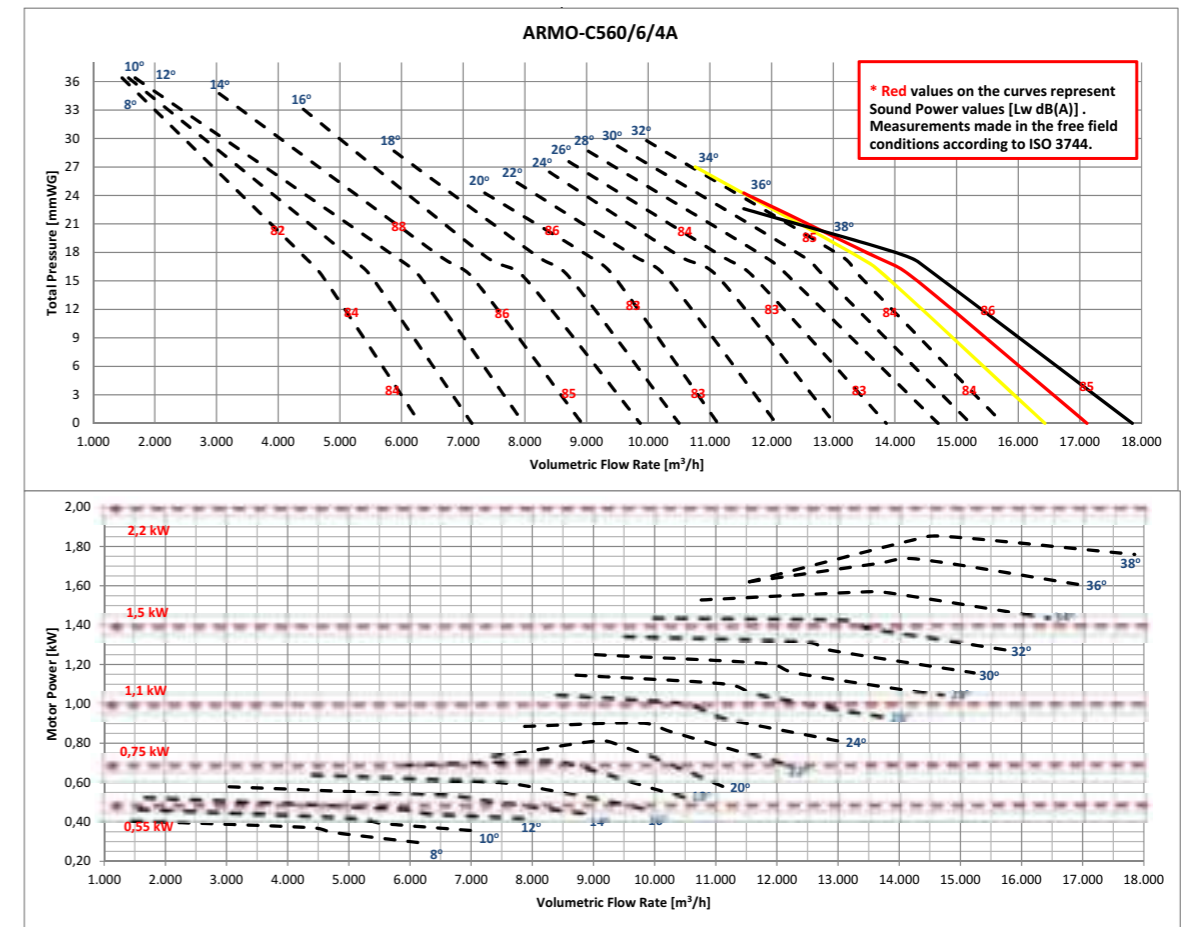
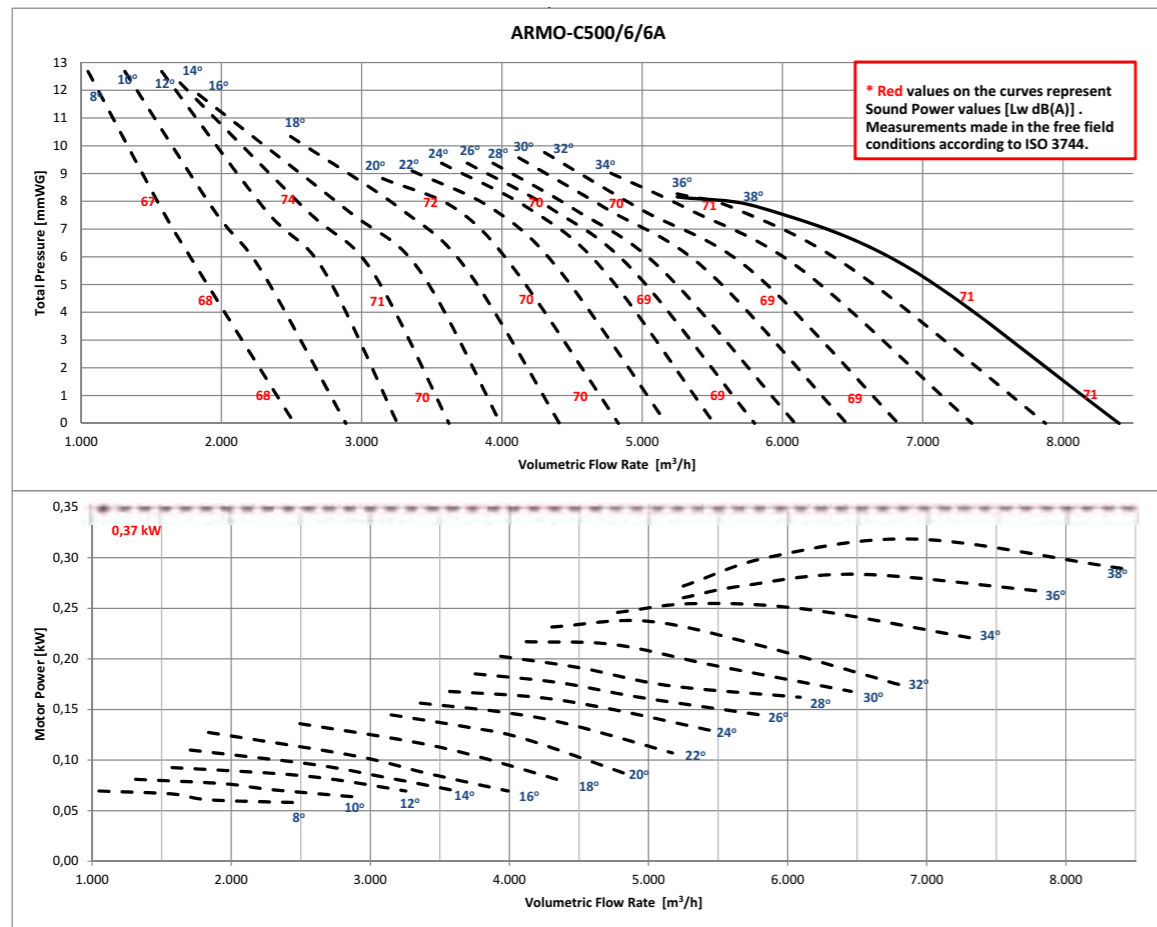

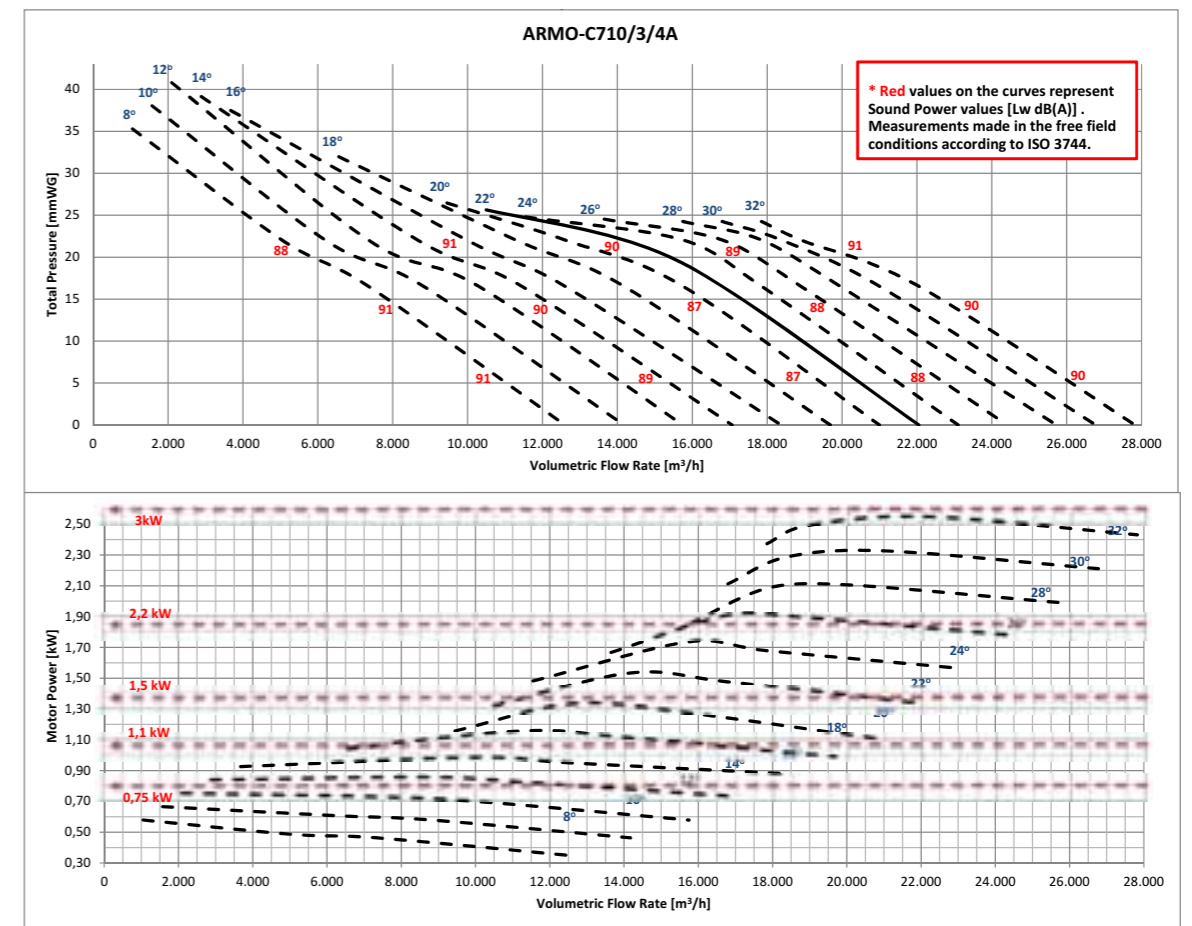
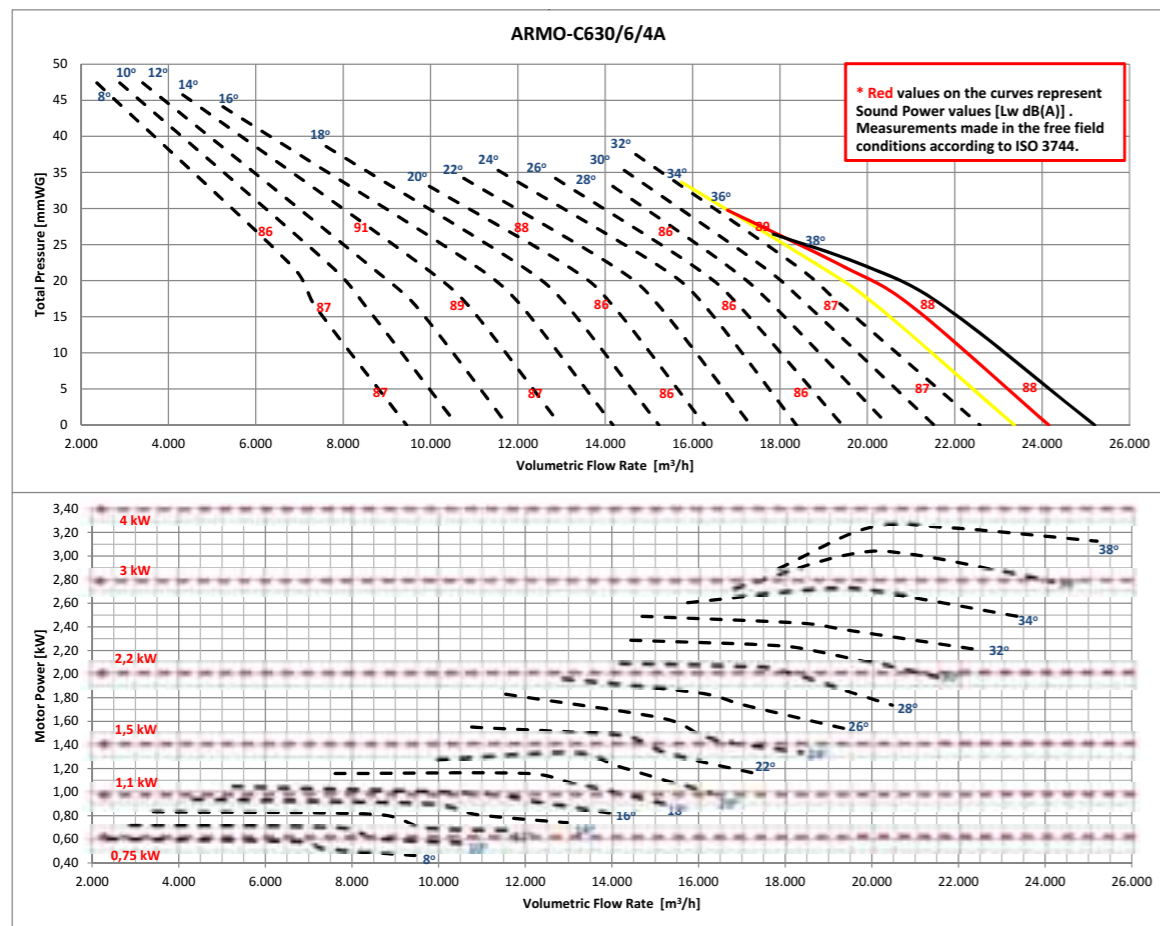
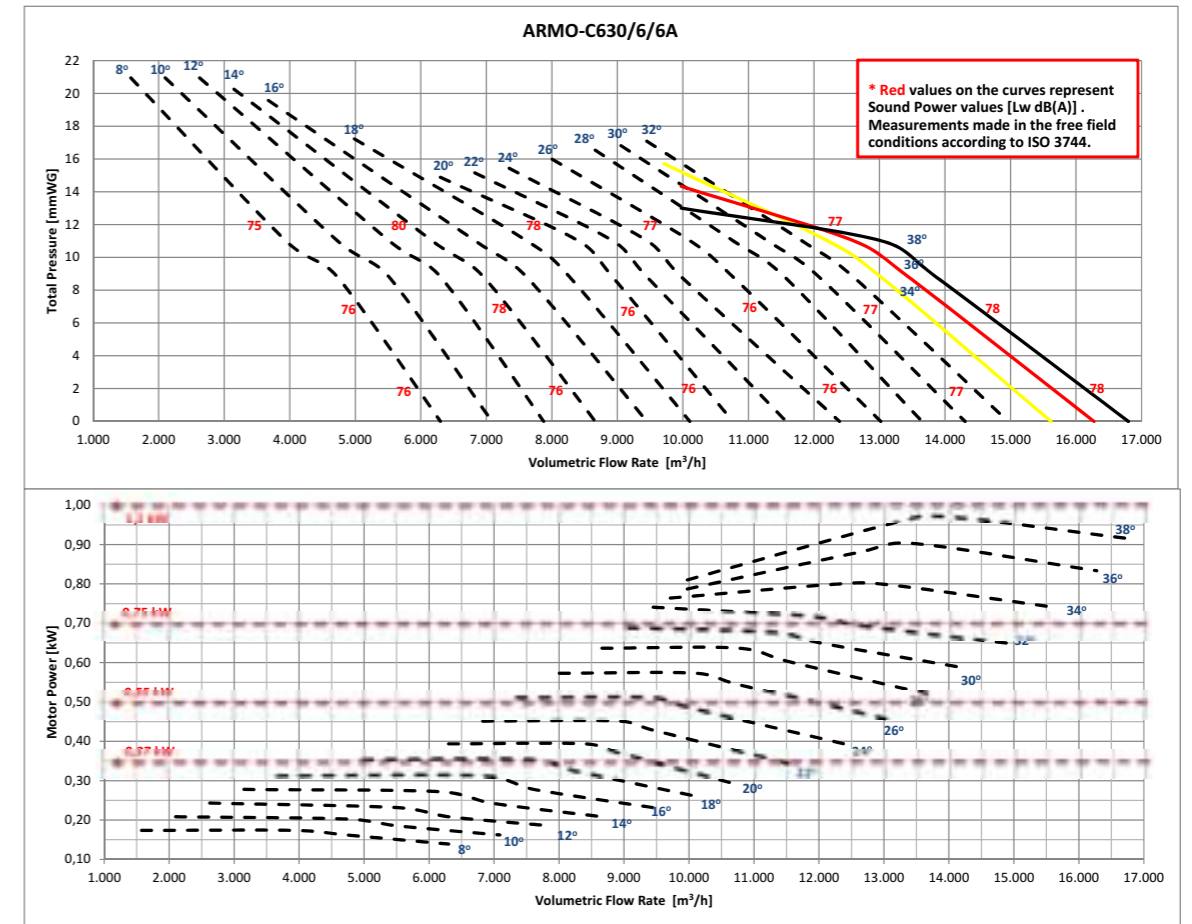
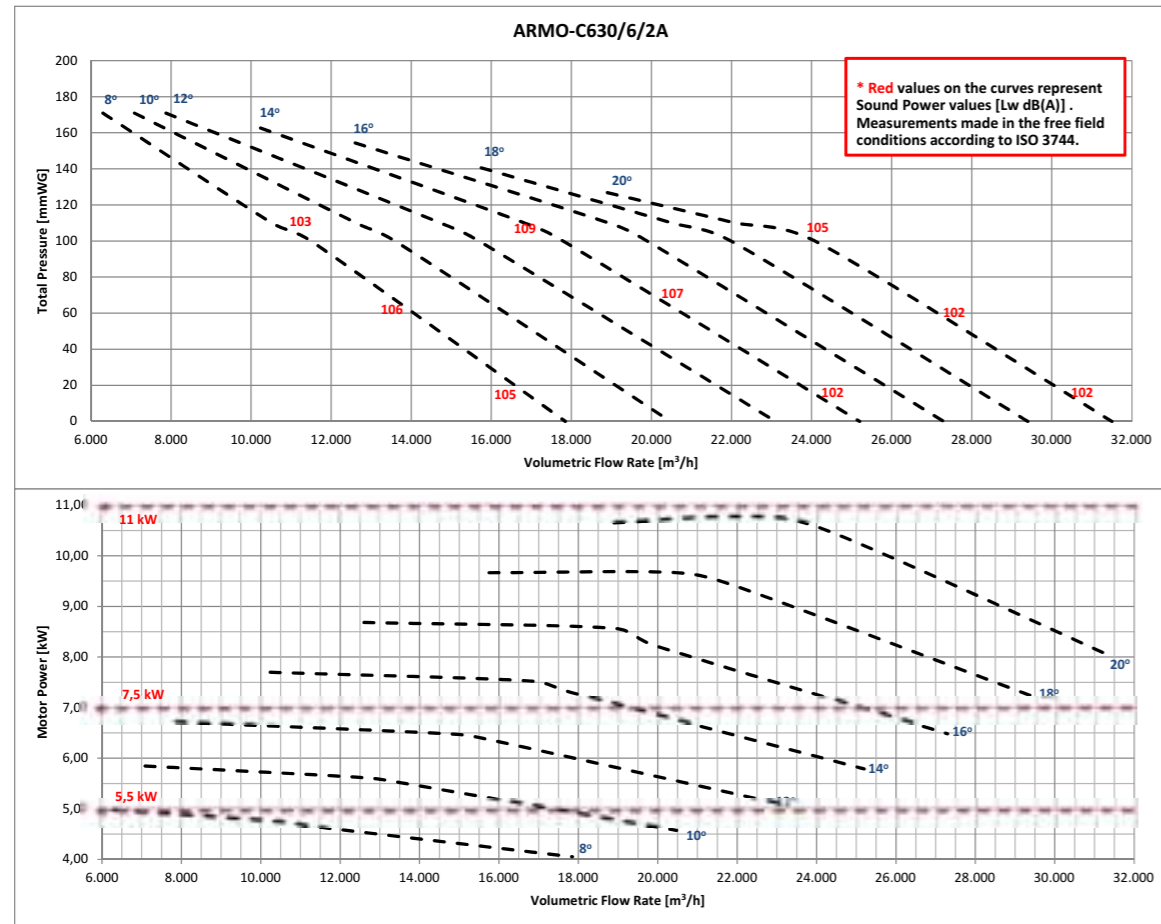

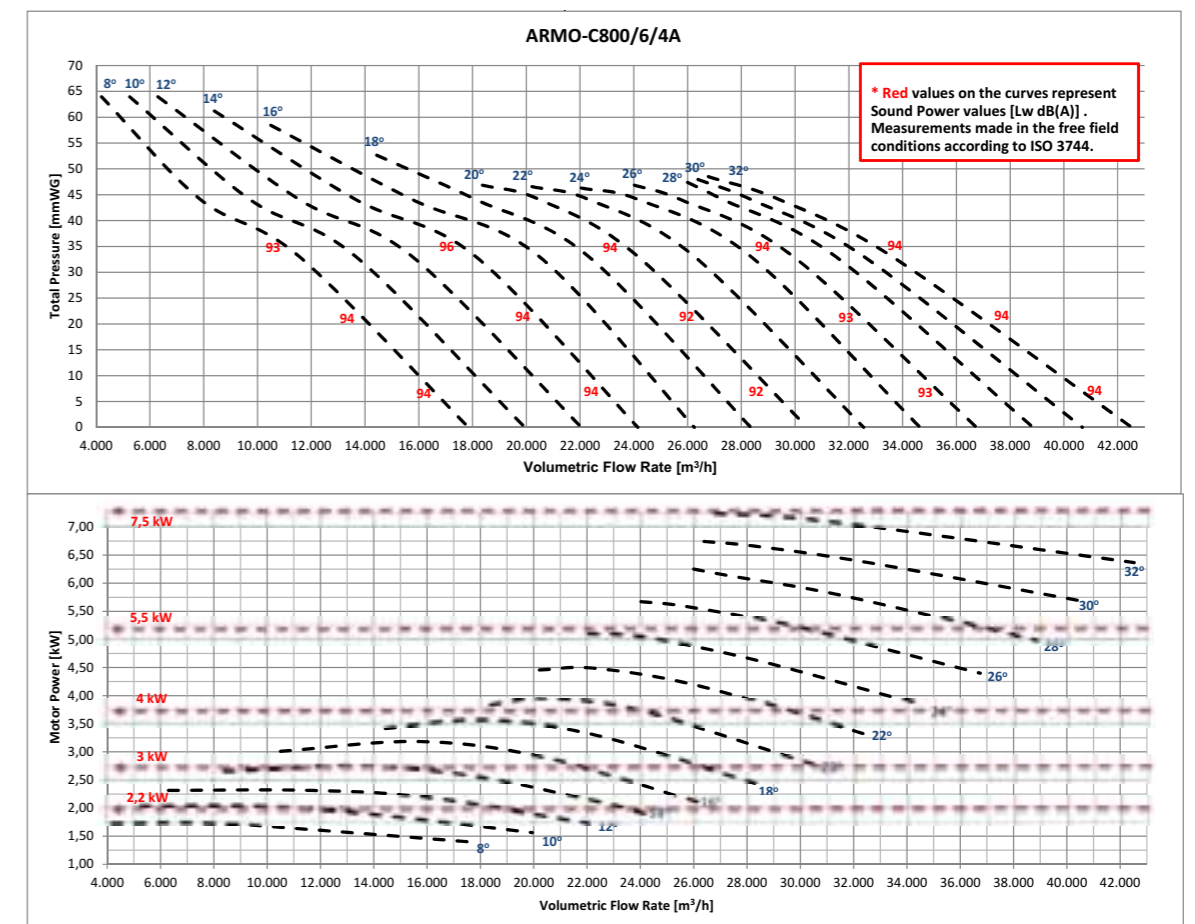
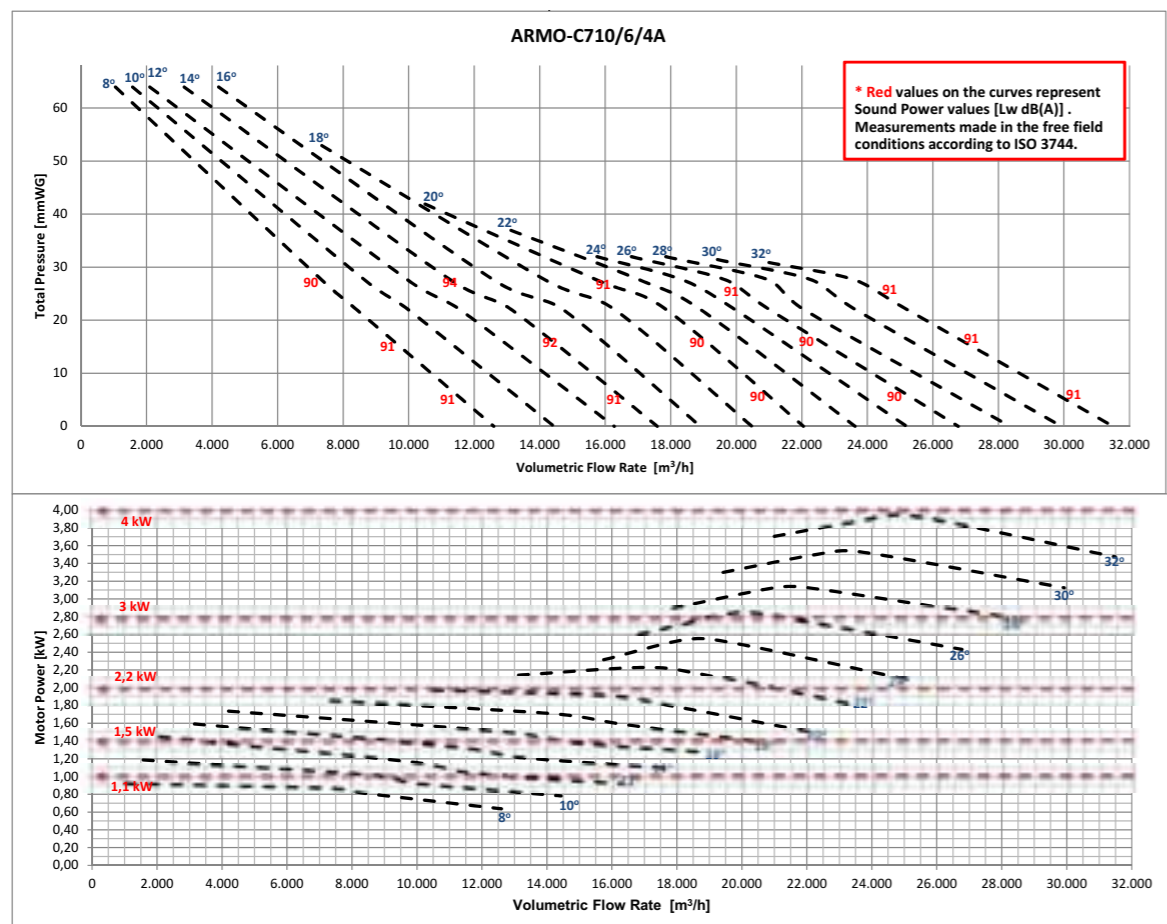
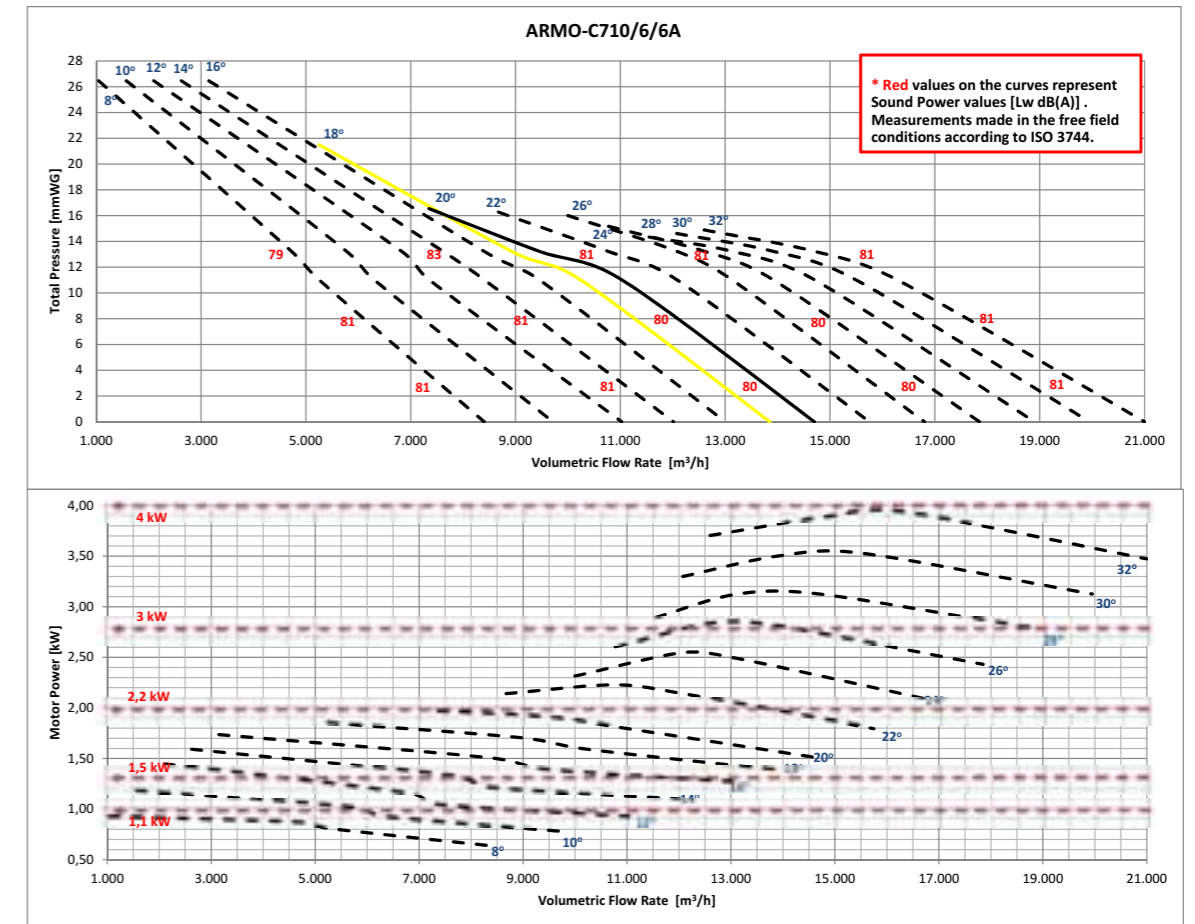
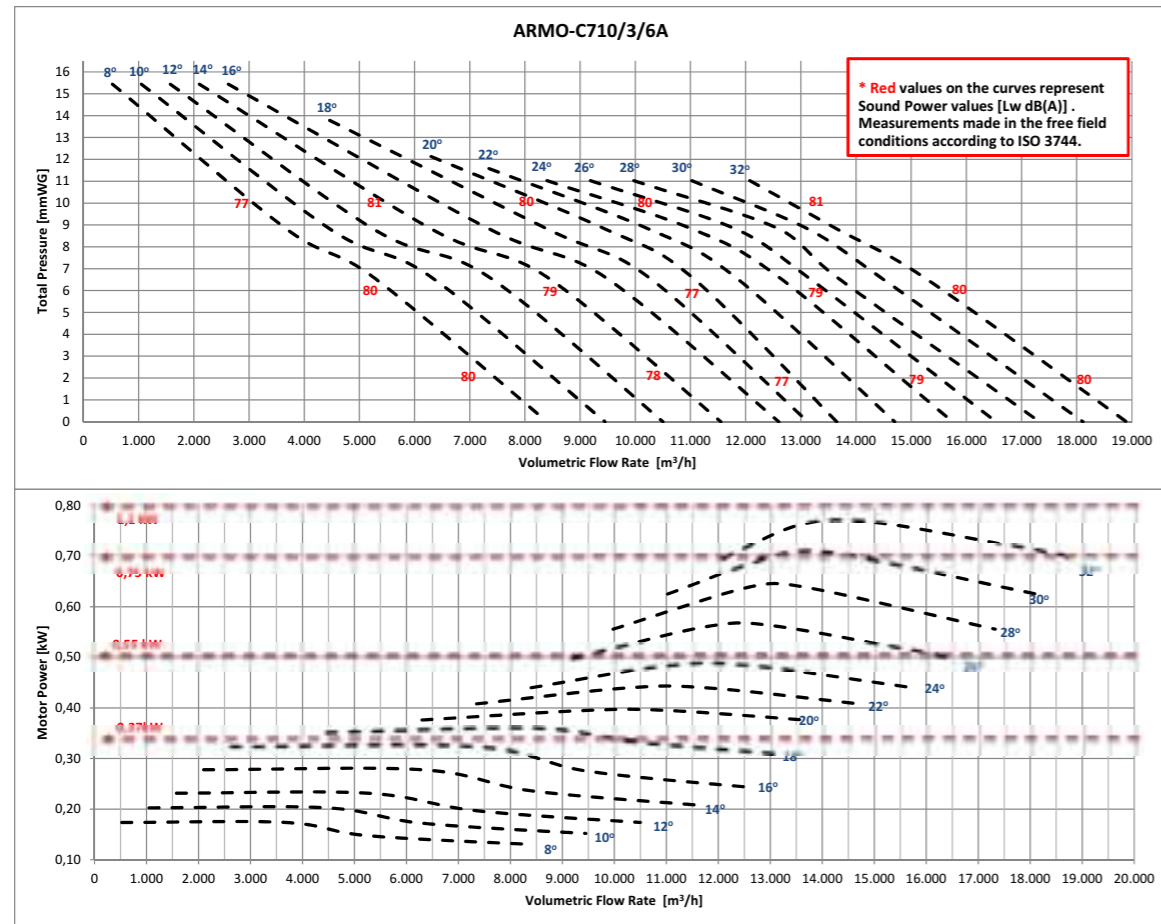

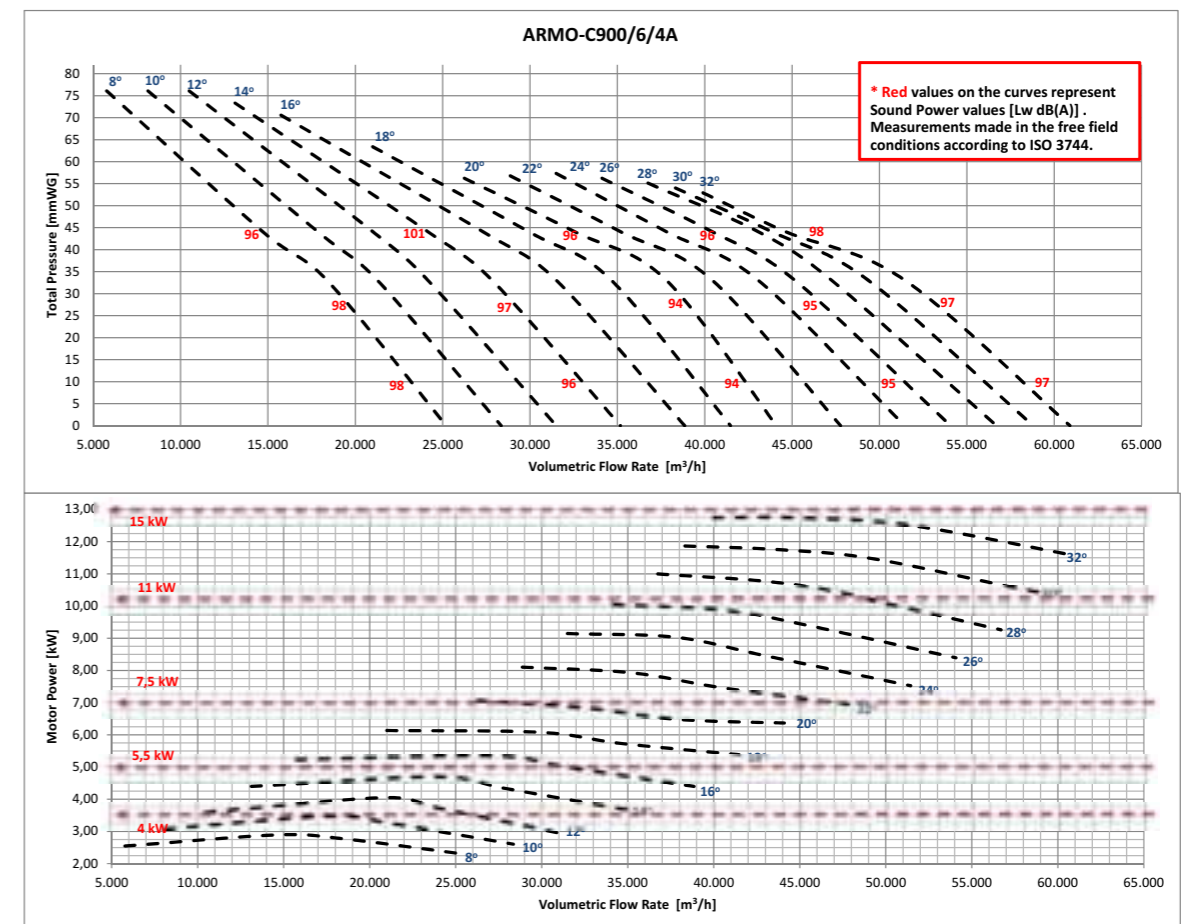
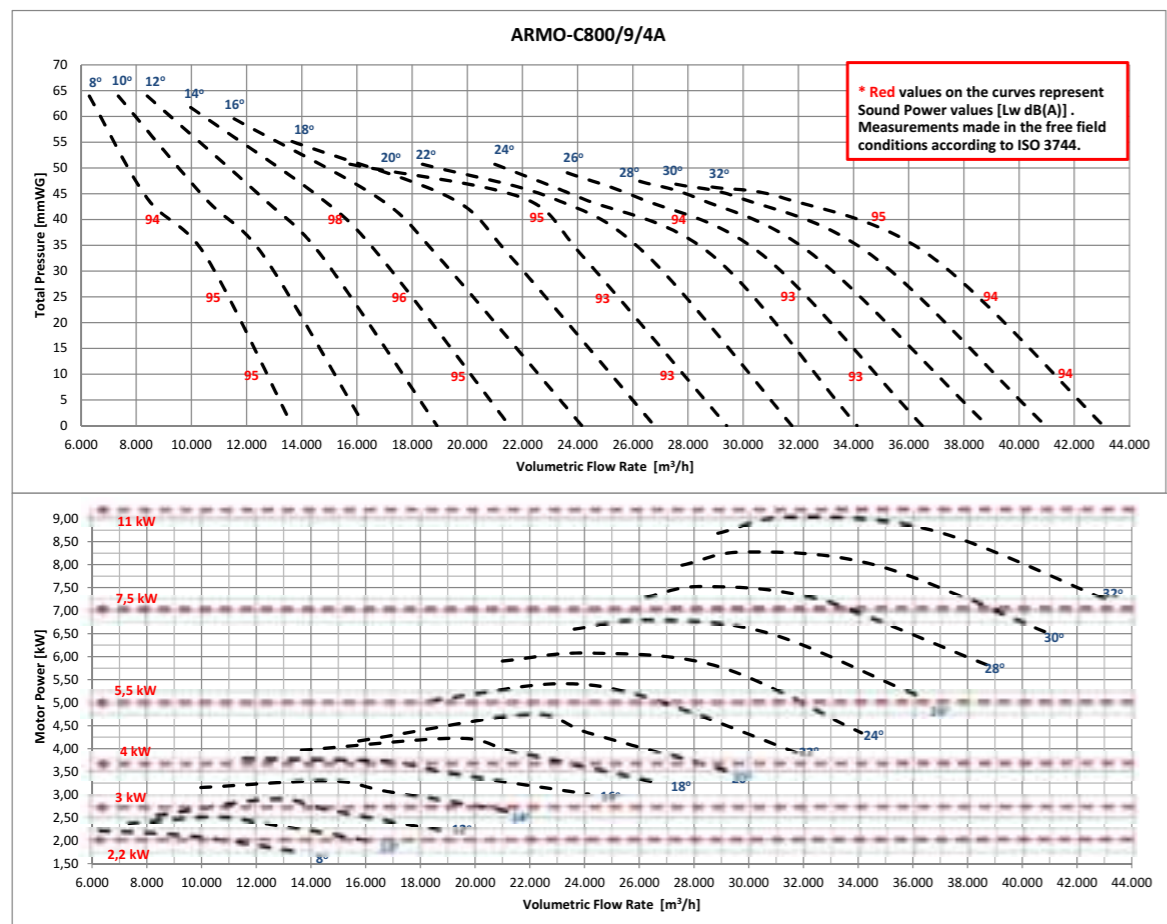
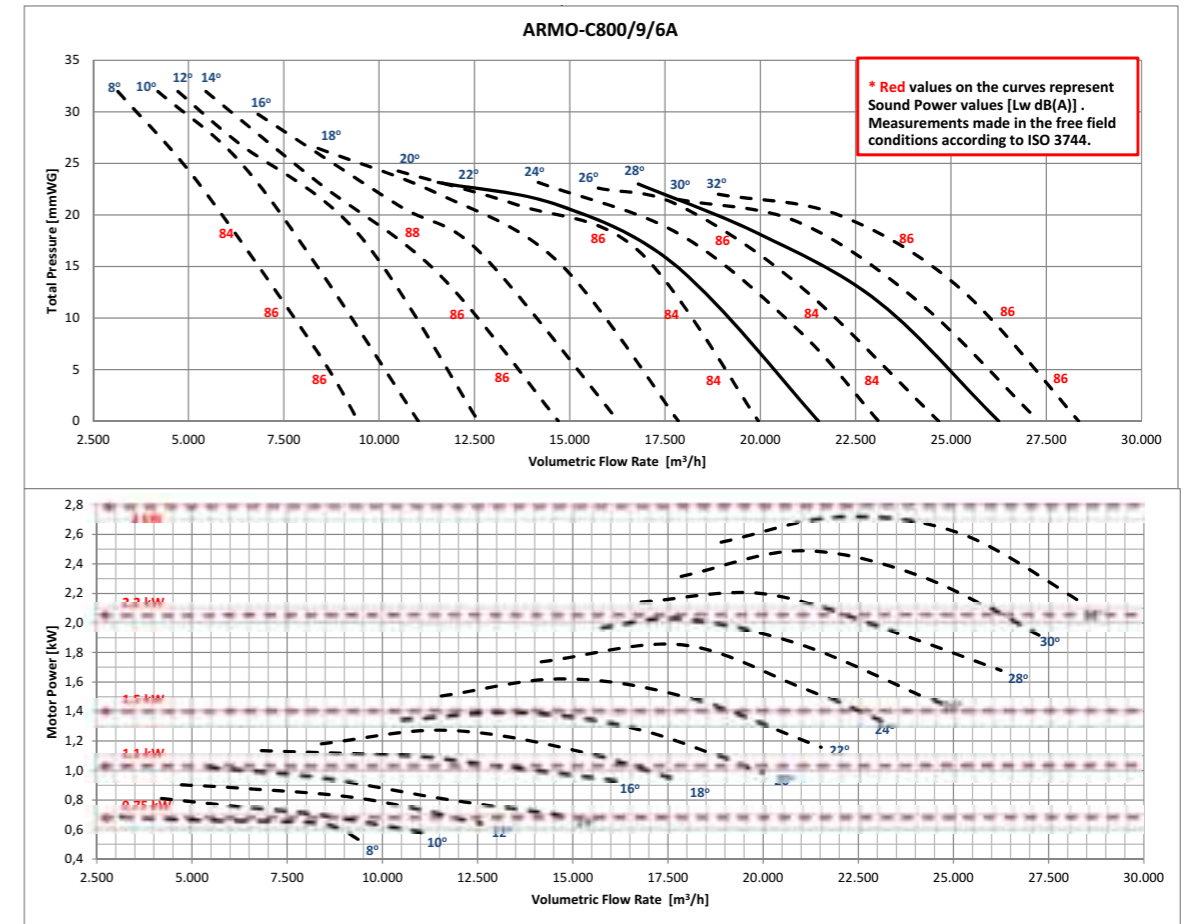
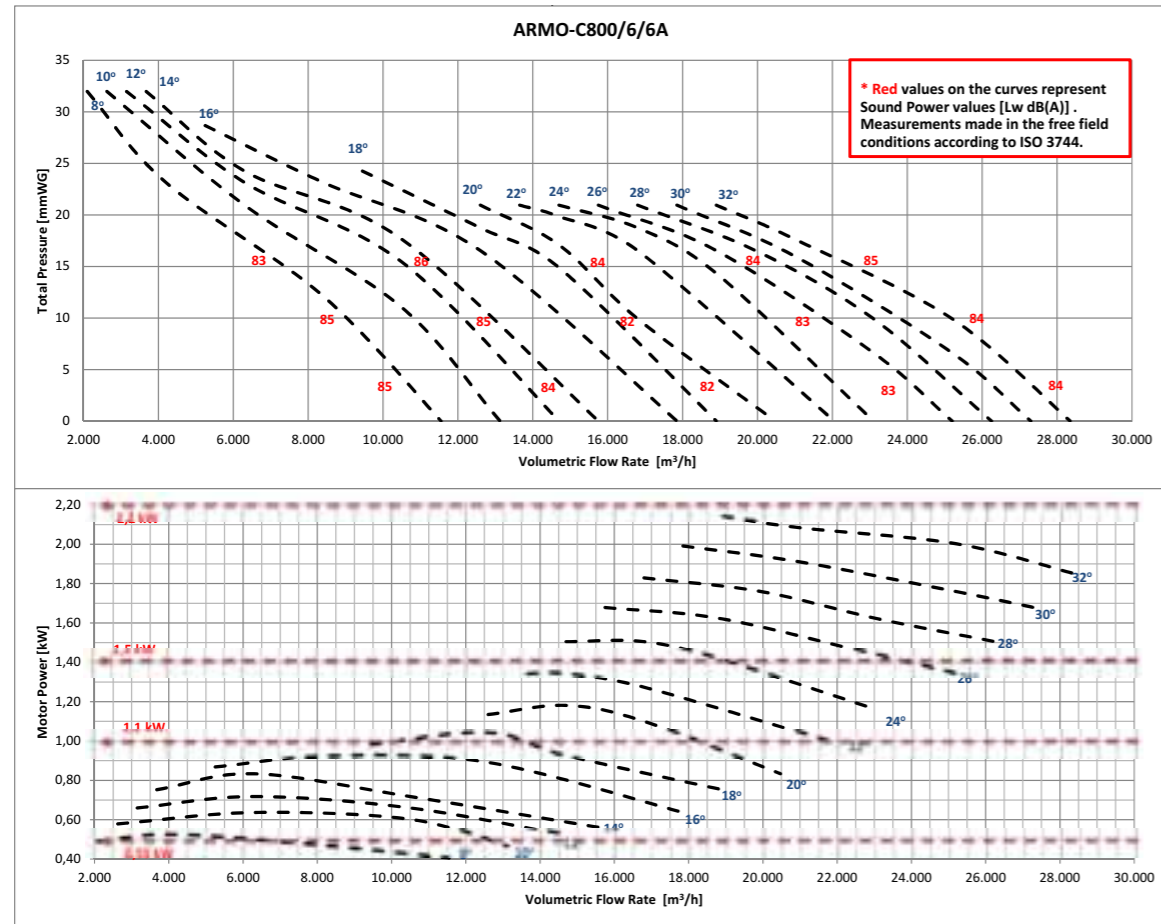

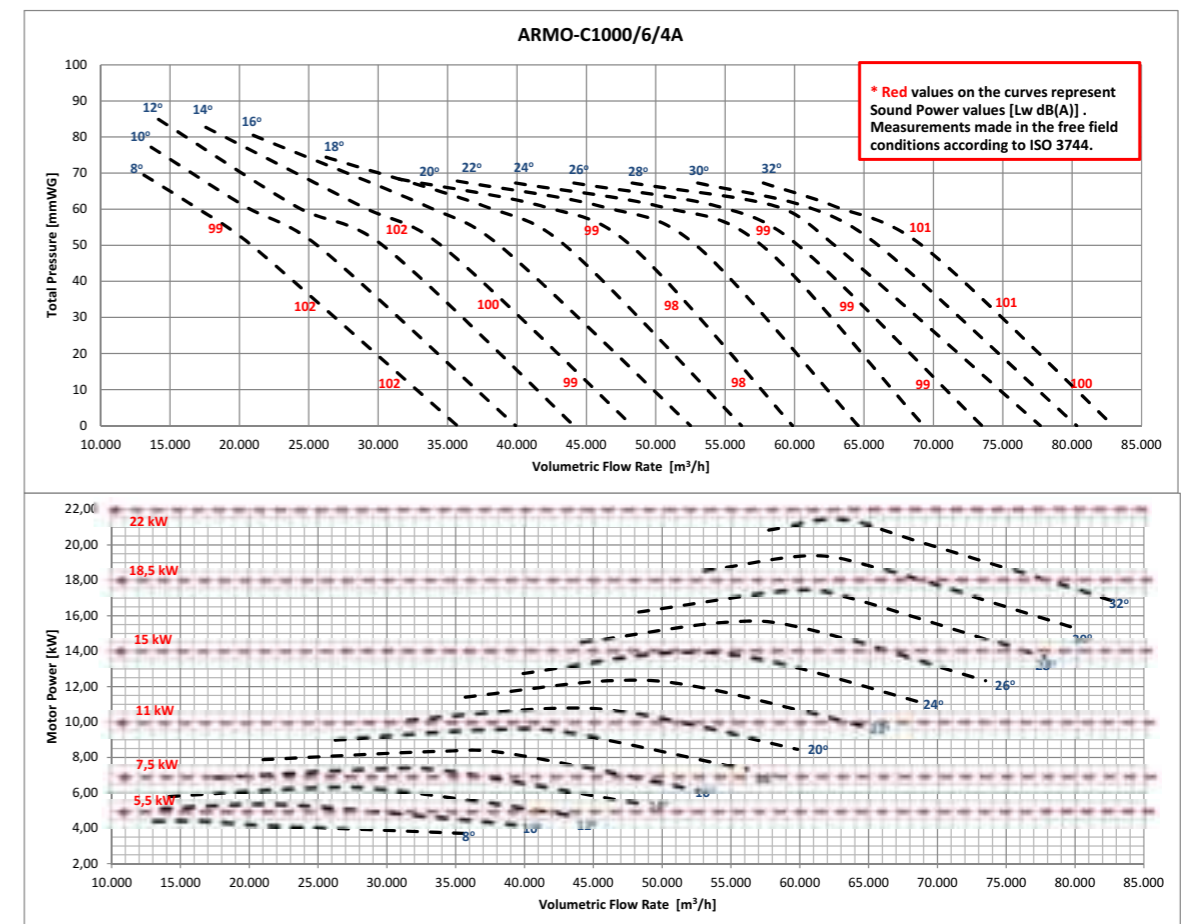
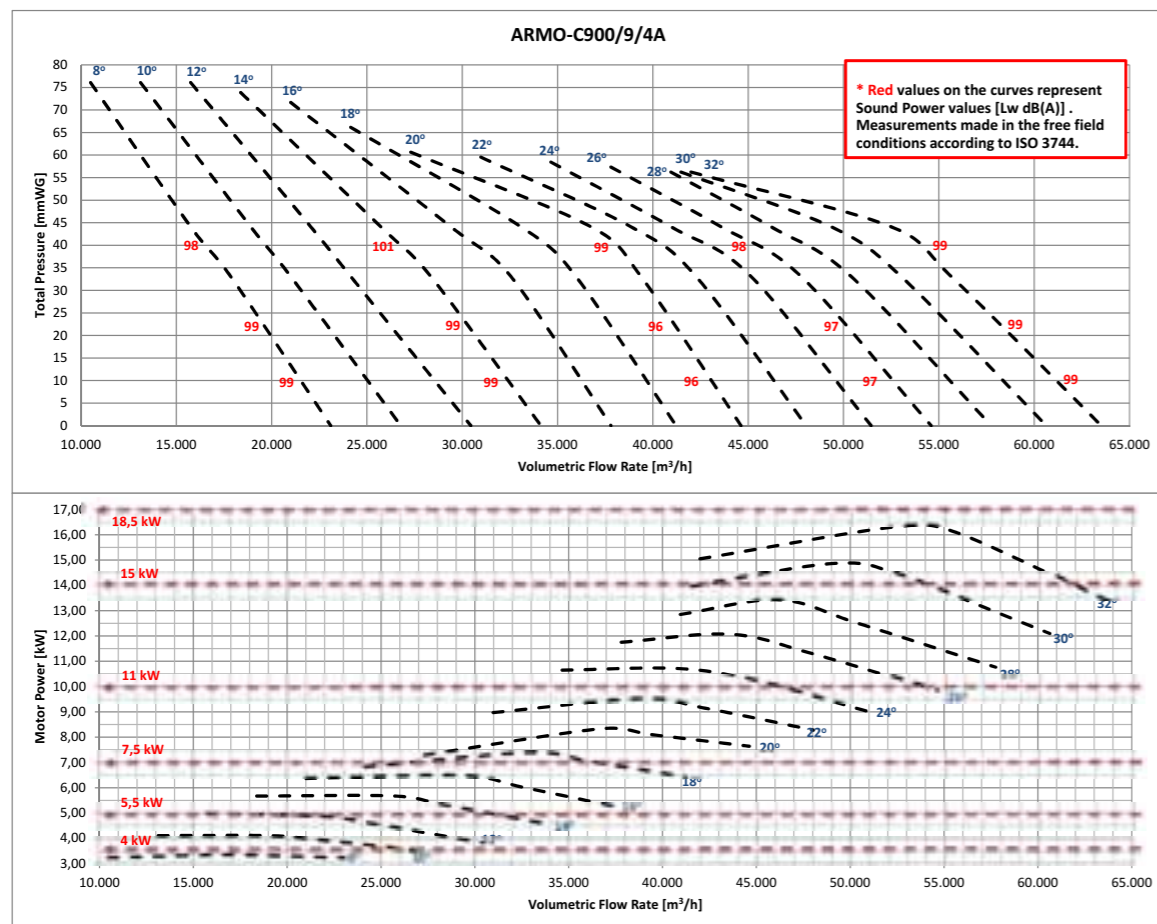
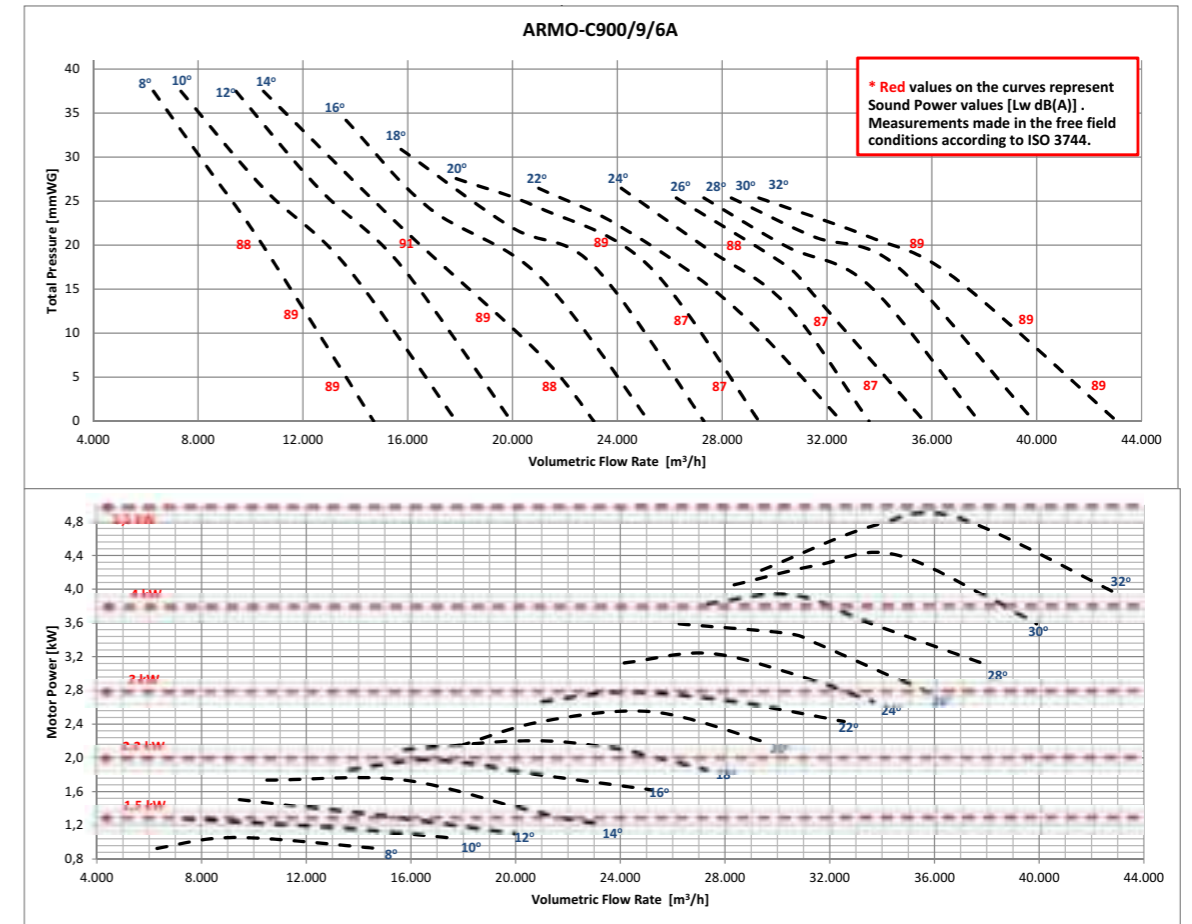
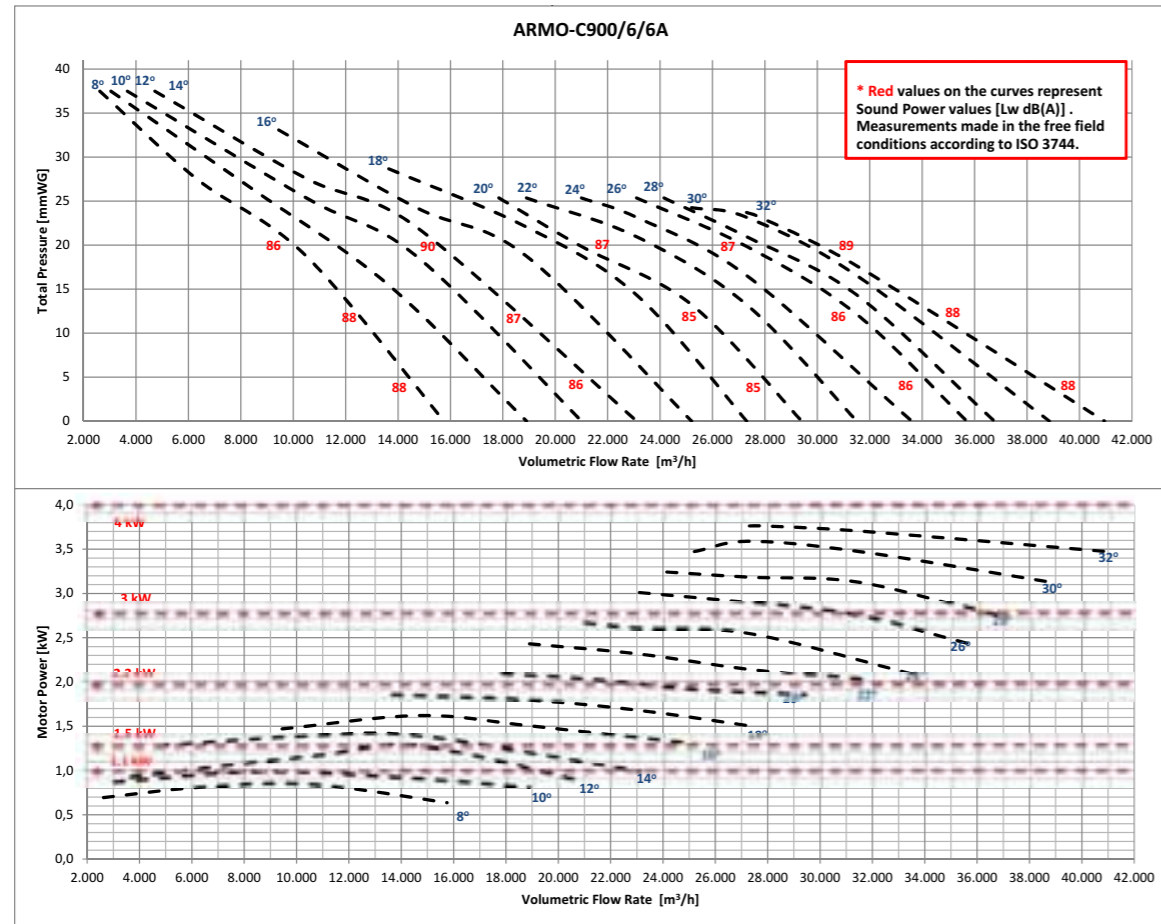

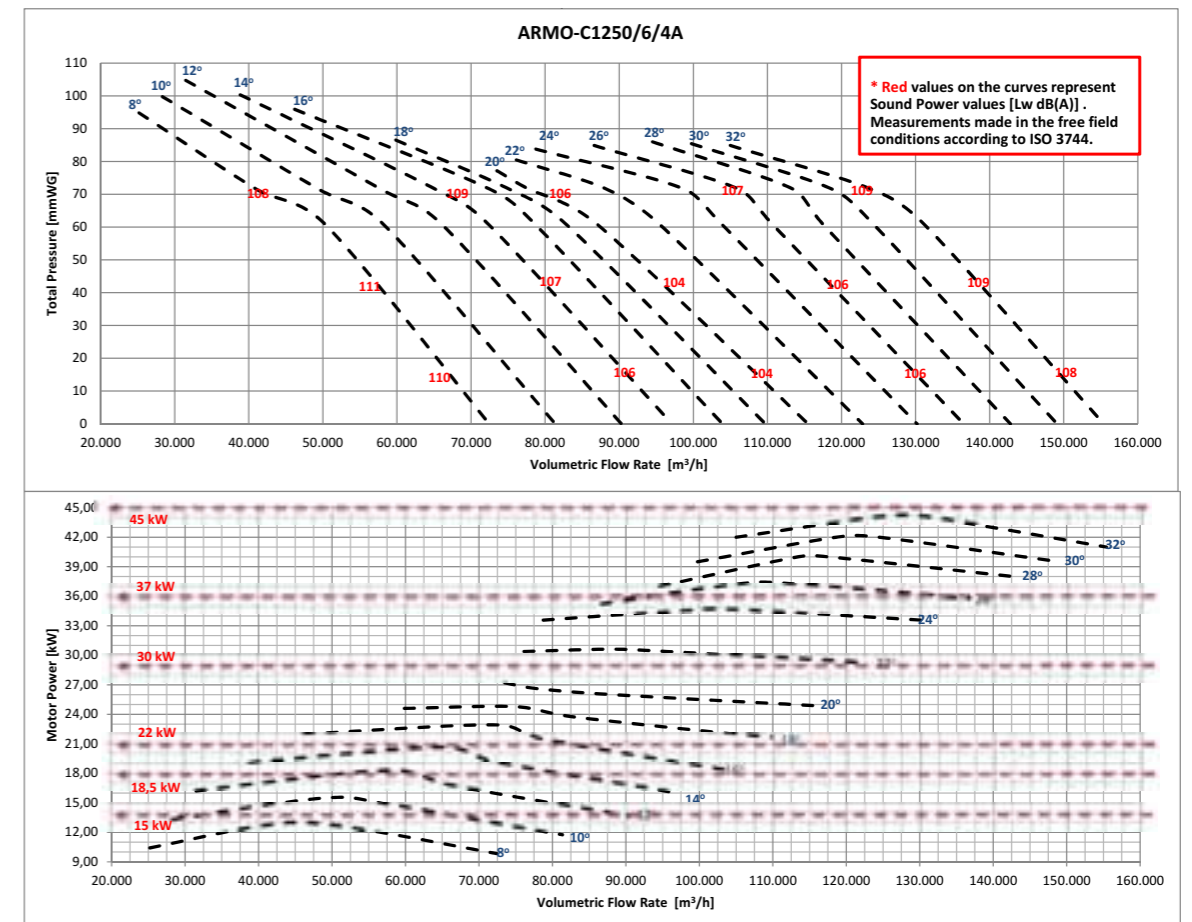
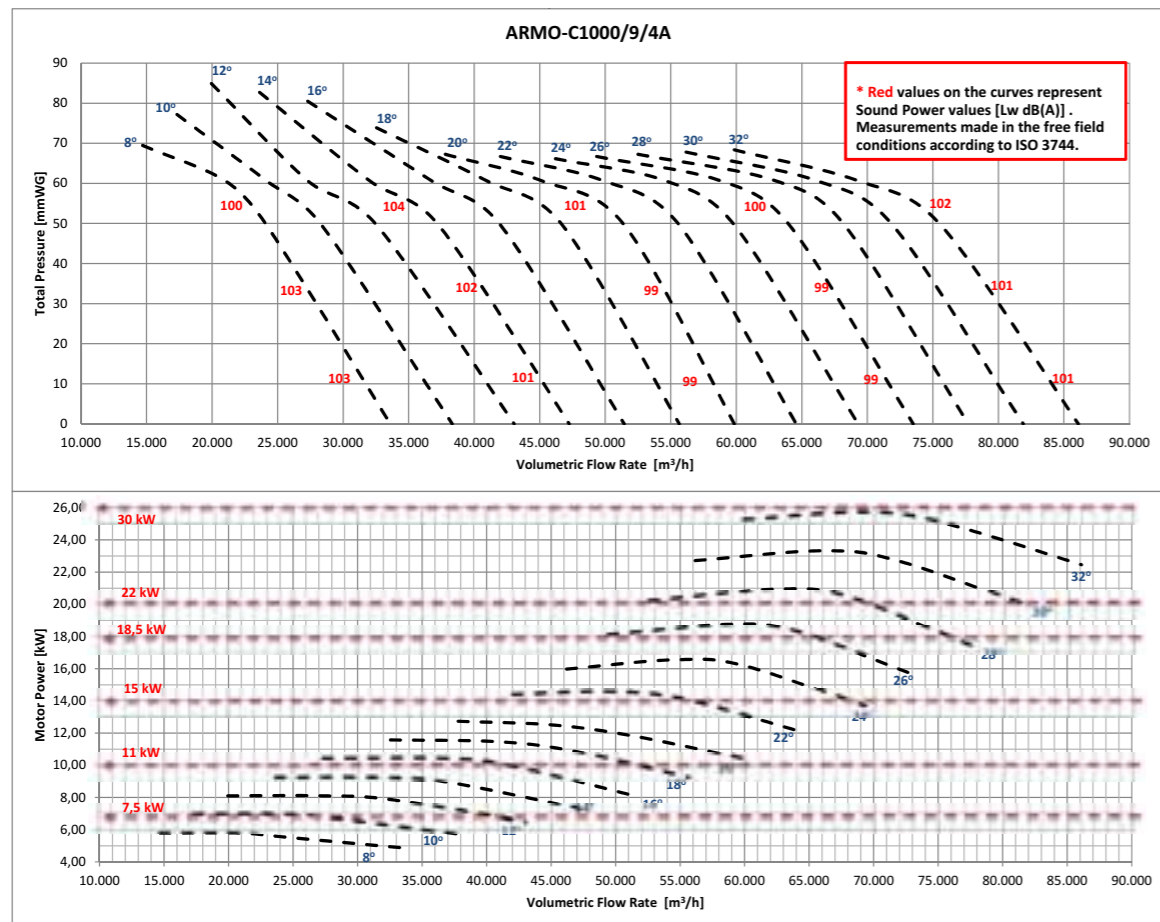
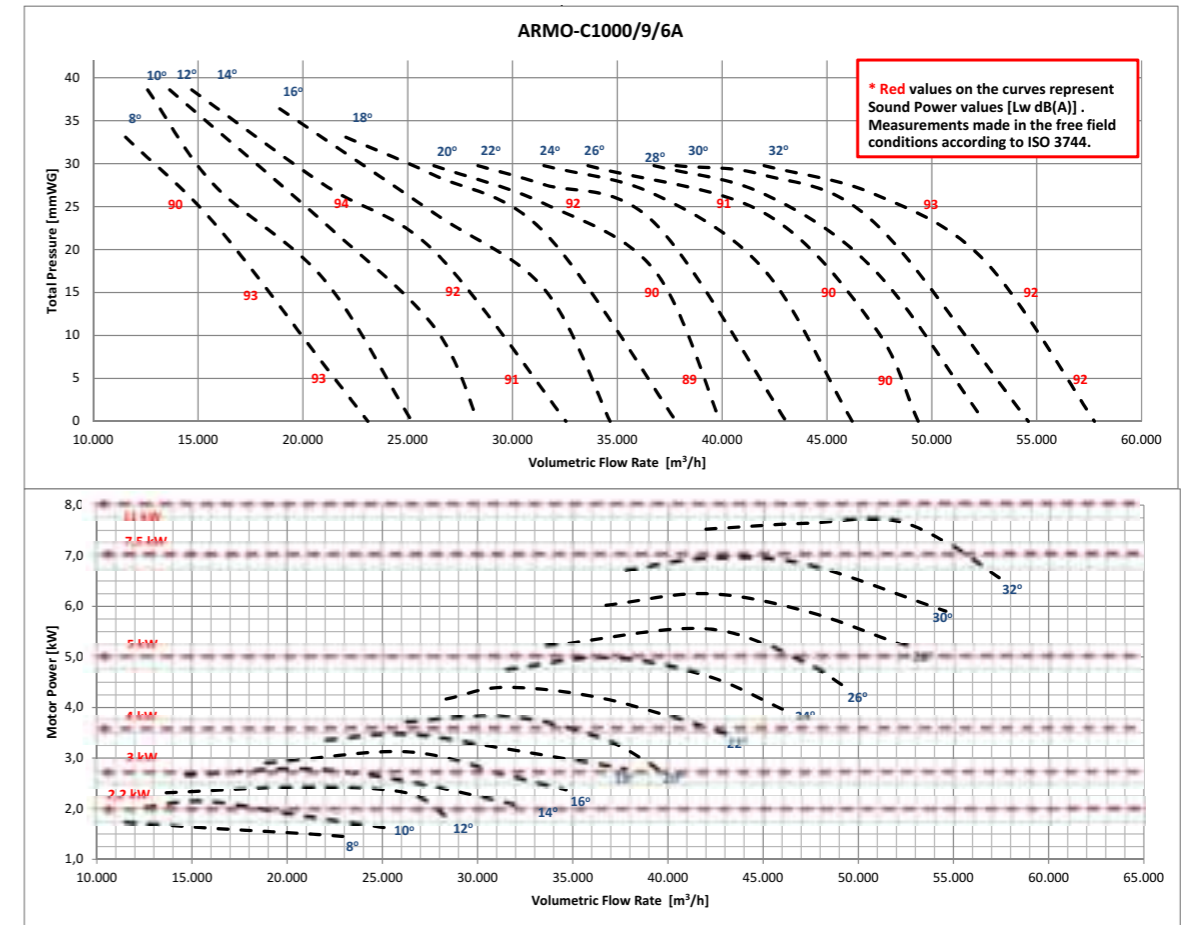
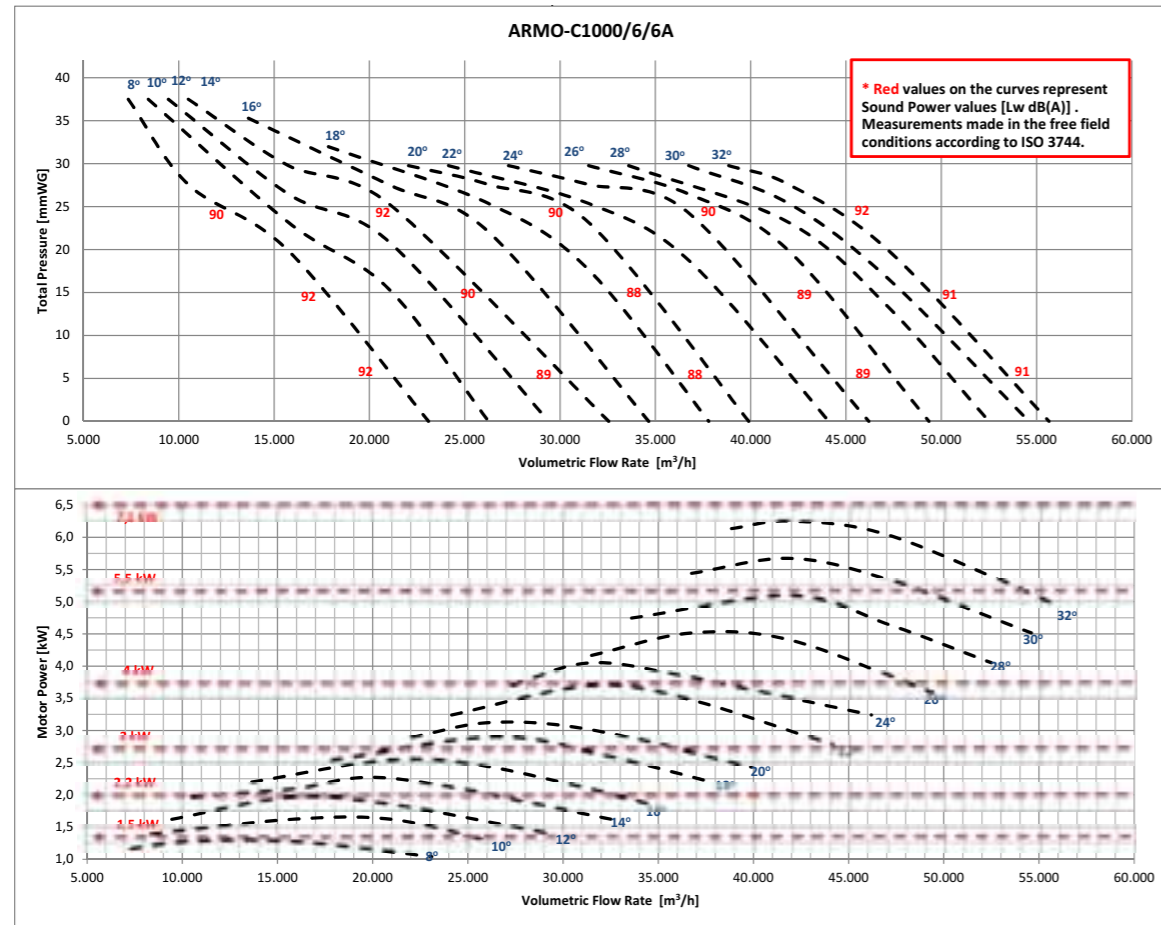

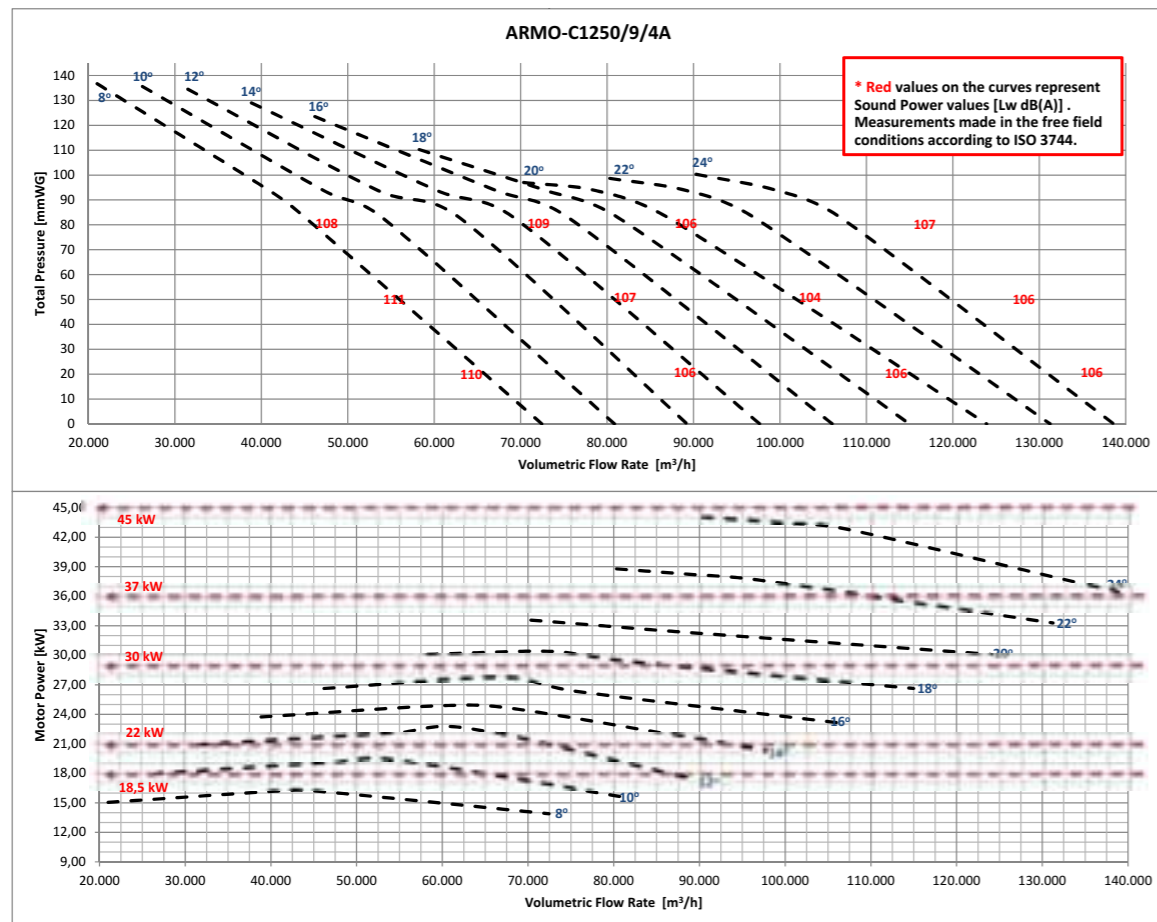
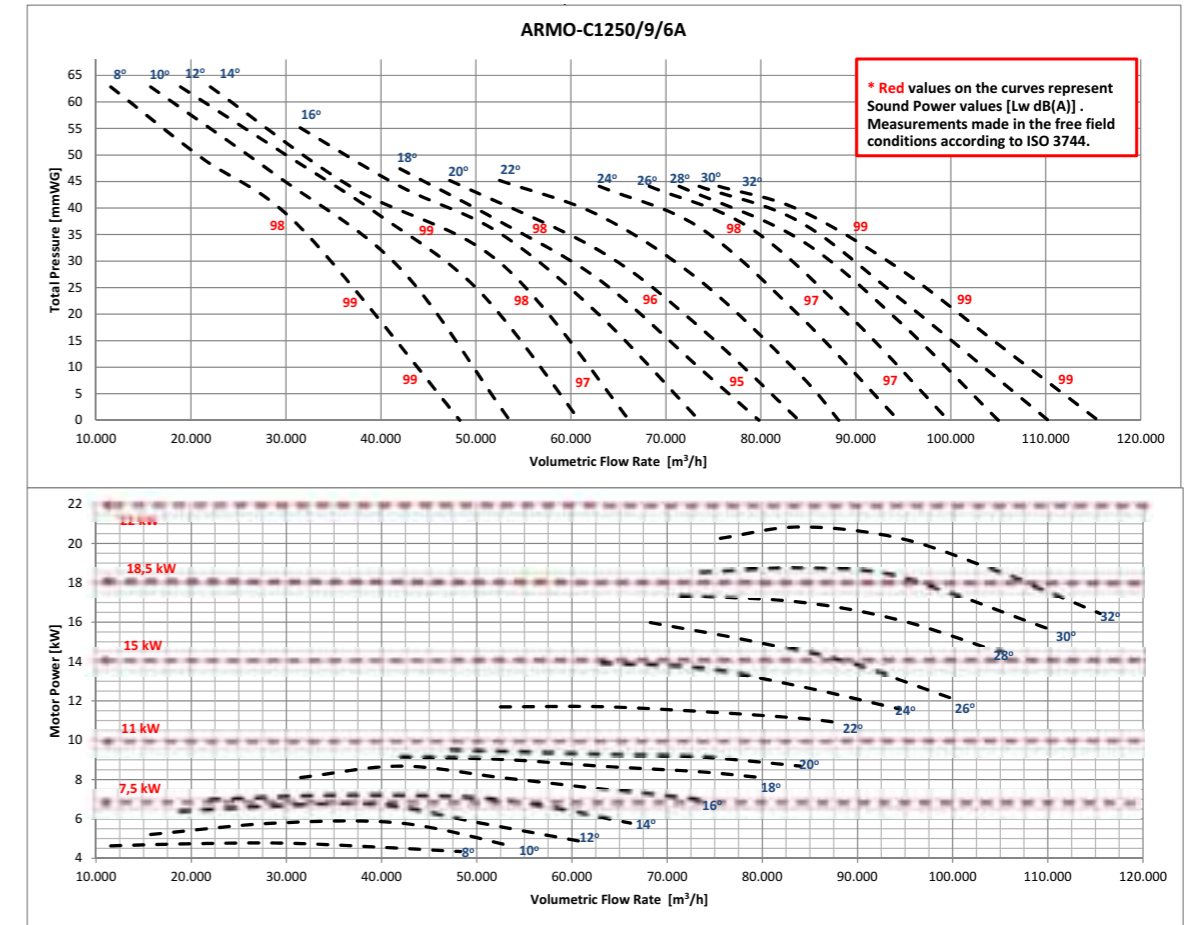
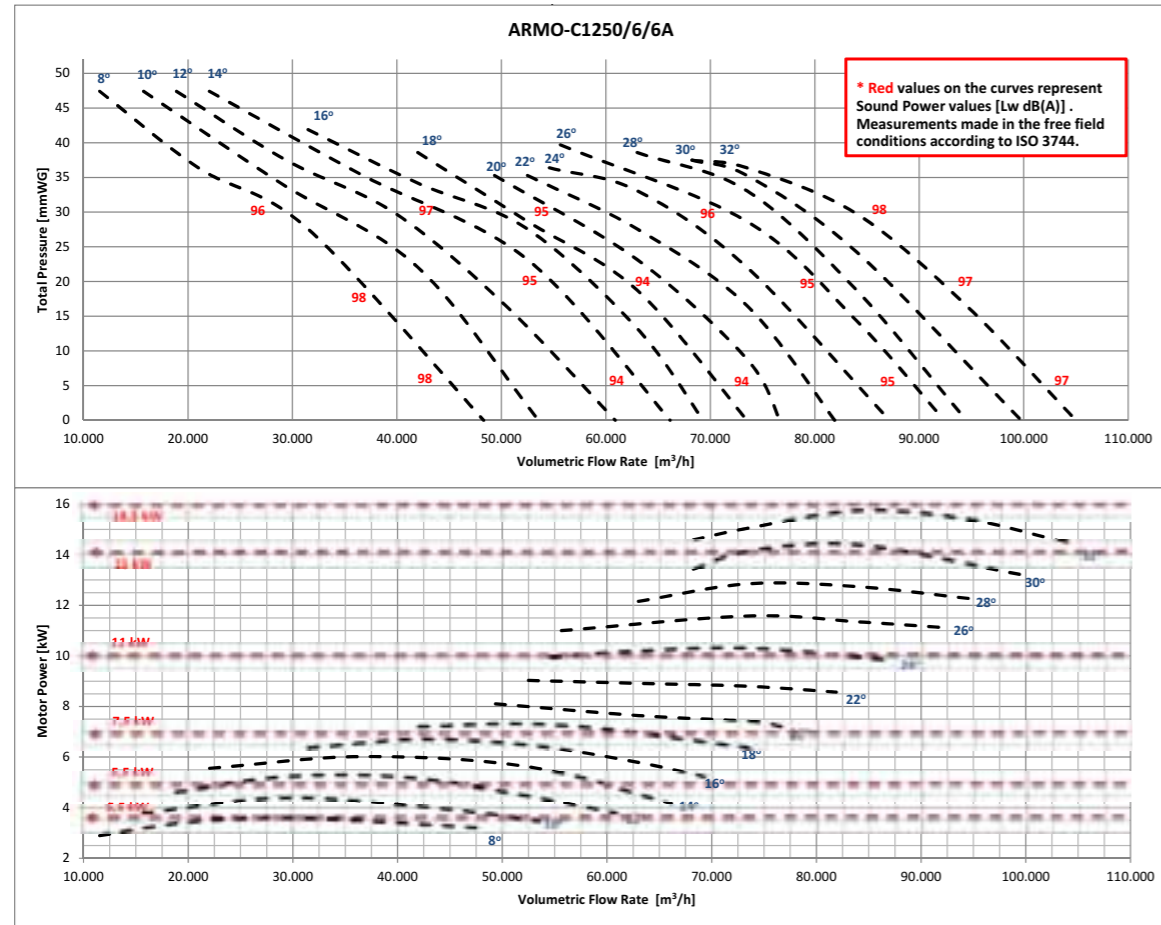

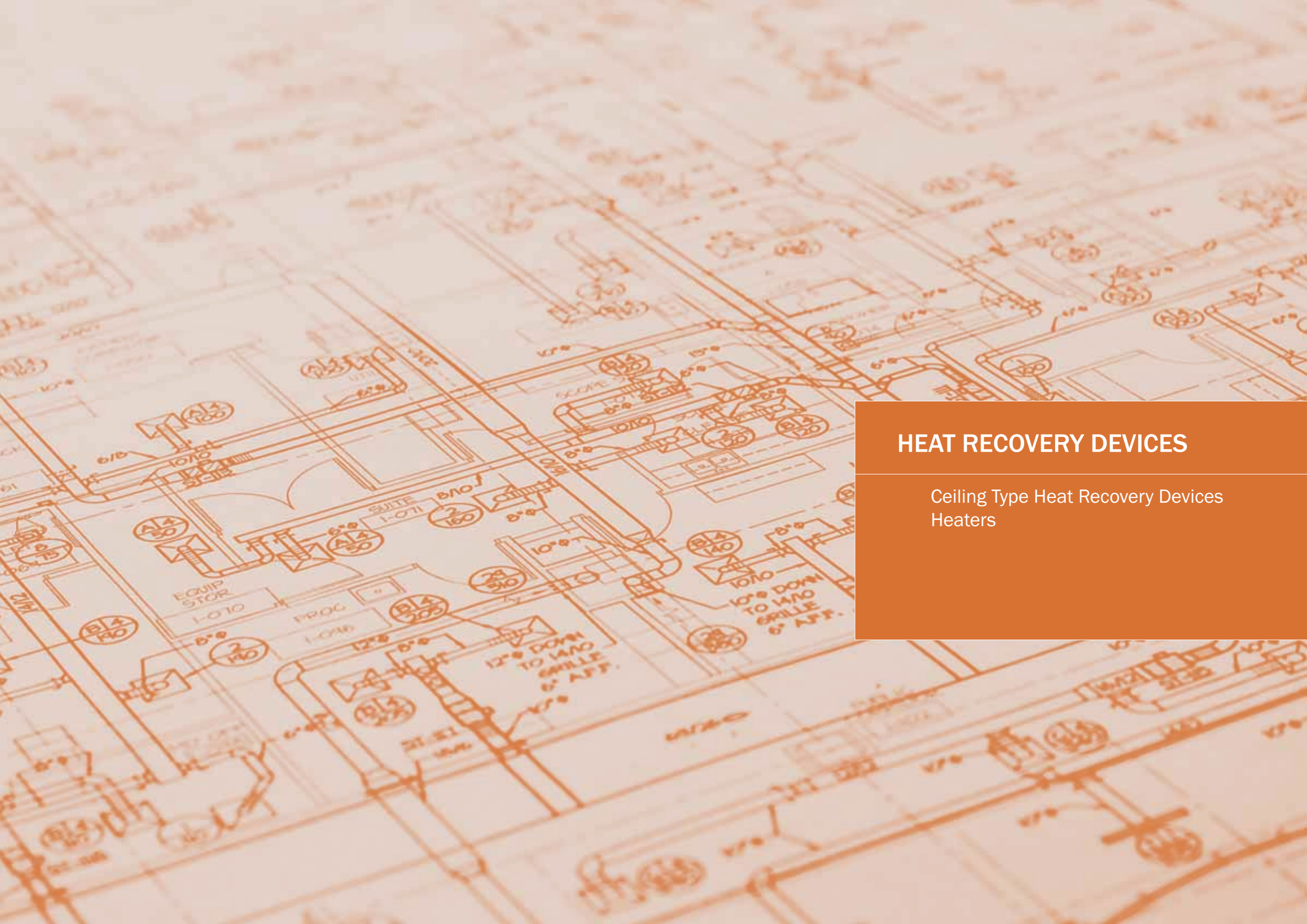

HEAT RECOVERY DEVICES

Ceiling Type Heat Recovery Devices
Heaters

HEAT RECOVERY DEVICES

BGK Devices are used in Hotels, Malls, Business Centers, Hospitals and similar applications to meet the needs of fresh air and removal the wasted air from the place.

Thanks to the high efficiency plate heat exchanger, the exhausted air and fresh air from the outside transfers heat and the process provides preheated air in the winter conditions and precooled air in the summer conditions.

In the meantime, since no additional energy is consumed, energy to be consumed for heating or cooling the fresh air is obtained from the ambient air.

Product Specifications:

- ◆ In the devices, high pressure static and dynamically balanced, motor-driven direct coupled silent operated external rotor motor radial fans are used.
- ◆ The whole body is made of galvanized sheet which can resist to corrosion.
- ◆ The body of the device is insulated with polyethylene insulation material against sound and heat.
- ◆ Electrical Heater Specifications: Resistance electric heater, Limit upper and lower safety temperature thermostat.
- ◆ Easy service for fan, motor and filters.
- ◆ Due to recovery of the exhaust air, it reduces the initial buying investment and sustainable operating costs.

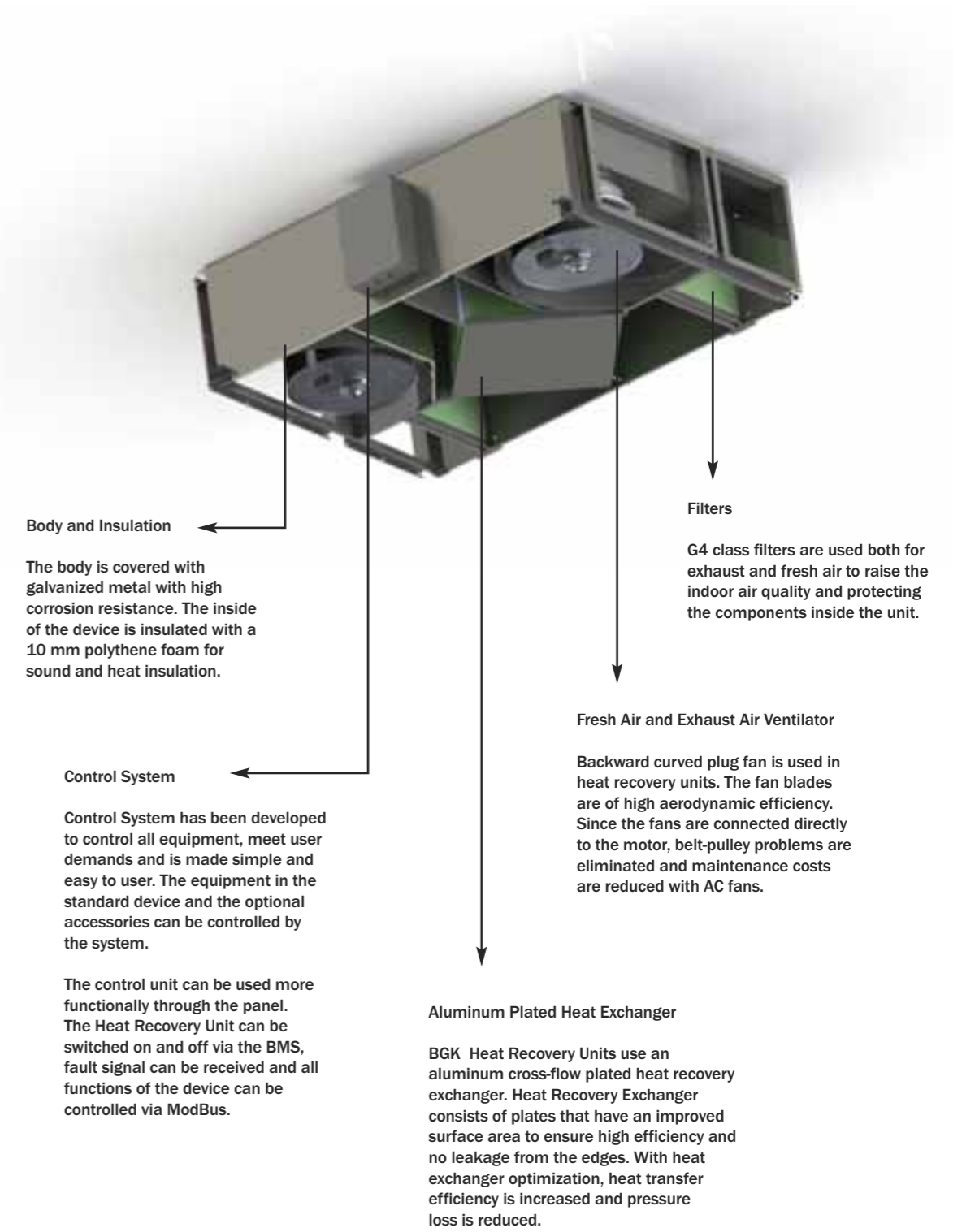



BGK

CEILING TYPE HEAT RECOVERY DEVICES / Plate Heat Exchangers

Device Components and Material Properties

The body is manufactured from galvanized sheet metal. Some of the fans of the BGK are made of high quality galvanized steel which is resistant to corrosion and some models are made of aluminum material to meet their performance requirements. All models have an external rotor motor with closed structure. The device is capable of handling air at max.40°C. It consists of high efficiency plate heat exchanger, external rotor motor plug fan, filters and control panel components. An electric heater is available as an option.

Device Structure

Polyethylene insulation material is used for sound insulation and thermal insulation of the device body. There is a condensation pan designed to drain the condensate on the heat recovery exchanger.

Speed Control

Heated electric heater, low and high limit safety temperature thermostat.

Benefits

By means of the heat exchanger, the heat is transferred by means of heat exchanger without the mixture between the exhausted air and the fresh air taken from the outer space, pre-heating in winter conditions and pre-cooling in summer conditions. Since no extra energy is consumed in the meantime, some of the energy to be consumed for heating or cooling the fresh air is obtained from the indoor or outdoor air. Due to the recovery of exhaust heat, it reduces the initial investment and operating costs of air conditioning systems. The speed can be adjusted via the control panel. Easy access to plug fans and filters.

Usage Areas

School, hotel, shopping center, business centers, villa, hospital etc. structures where high amounts of fresh air are needed; It is used in cases where air freshening and air conditioning is desired to be done in an efficient way.

Technical Drawing and Tables

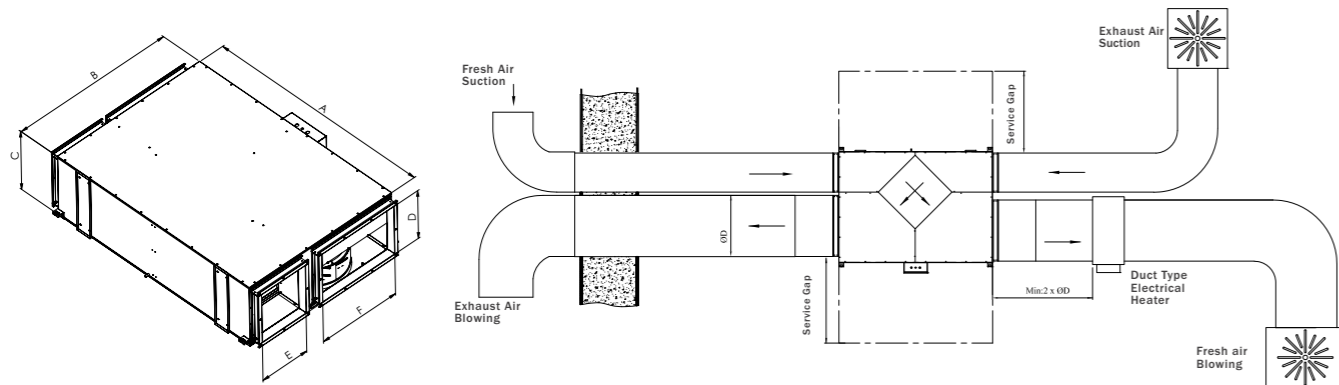

TYPE	A	B	C	D	E	F
BGK 75	1100	900	315	220	200	455
BGK 100	1200	1000	365	270	300	455
BGK 200	1500	1200	415	320	400	555
BGK 300	1700	1200	475	380	400	555
BGK 400	1800	1300	515	420	400	655
BGK 500	2000	1500	615	520	400	855

Dimensions are in (mm)

TYPE	VOLTAGE	FREQUENCY	POWER	CURRENT	CAPACITOR	SPEED	AIR FLOW	SOUND PRESSURE	INSULATION CLASS	PROTECTION CLASS	WEIGHT	ELECTRICAL HEATER	VOLTAGE OF ELECTRICAL HEATER
	V	Hz	W	(A)	(µF)	r.p.m	m³/h	dB(A)	Ins.cl.	IP	kg	kW	V
BGK 75	230	50	140X2	0,86X2	6	1440	750	46	F	44	80	3	380
BGK 100	230	50	200X2	1X2	8	1420	1000	46	F	44	113	3	380
BGK 200	230	50	310X2	1,55X2	10	1430	2000	48	F	44	150	5	380
BGK 300	230	50	500X2	2,5X2	10	1435	3000	49	F	44	180	8	380
BGK 400	230	50	780X2	3,5X2	16	1280	4000	54	F	44	200	10	380
BGK 500	230	50	1550X2	7,3X2	25	1250	5000	57	F	44	230	13	380

Sound Level Measured from 3m distance in room condition.

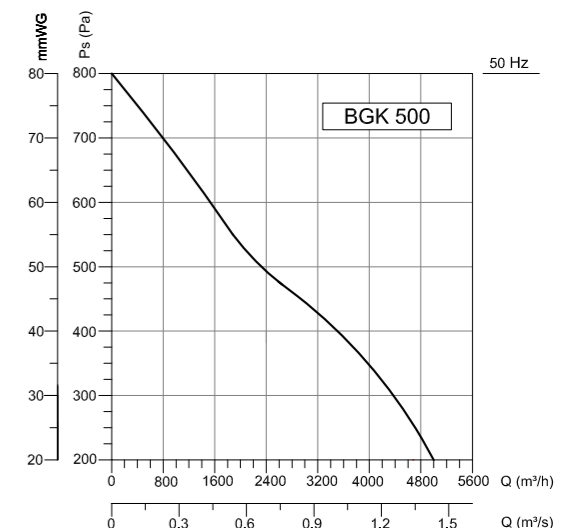
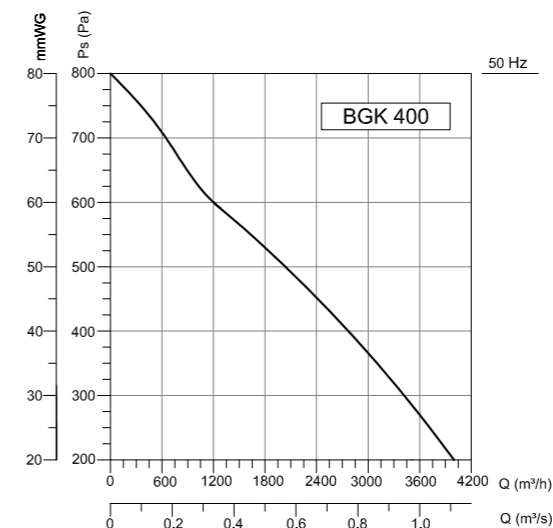
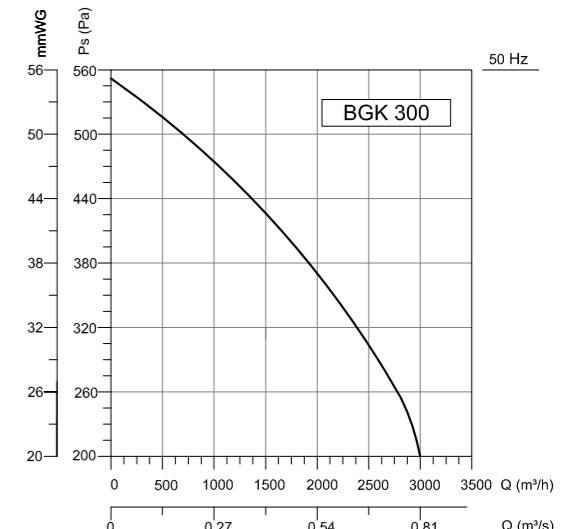
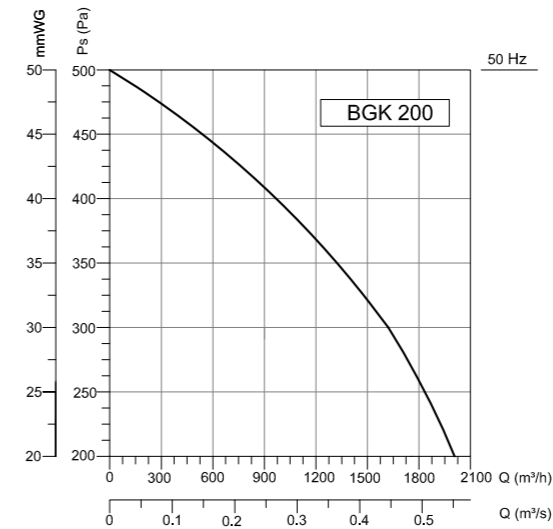
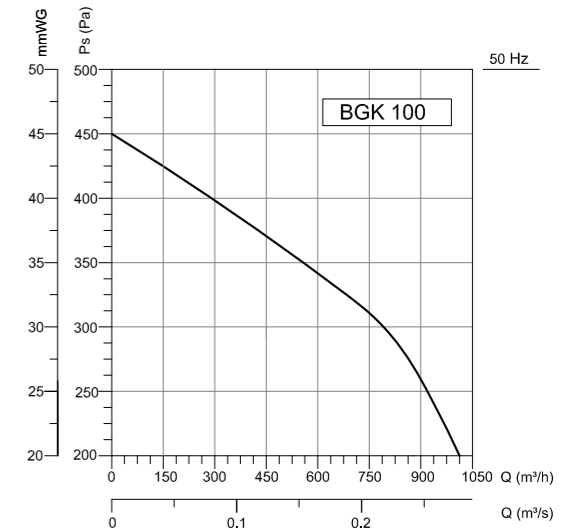
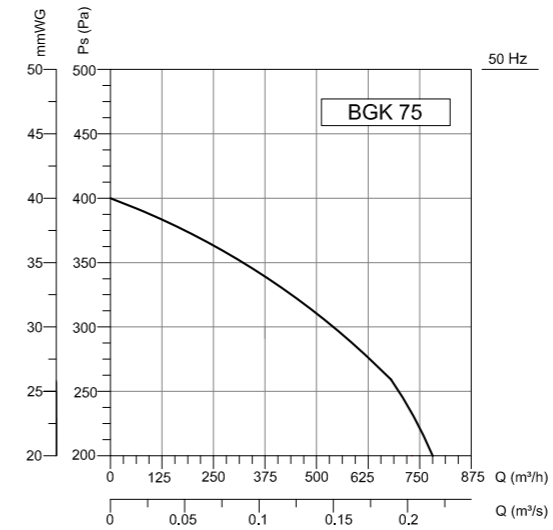

Accessories



BCTH BFG2 BFG3 BFG4 BFH13 BDH BDKS BDEB



BCTH

DUCT TYPE HEATING

Body material of channel type heaters are galvanized sheet or stainless steel sheet. Heating elements of the heaters produced as 304 stainless steel pipe as produced.

General applications are ventilation systems. Different channel types and these devices are produced according to the dimensions of the preheater to heat the outside air, they are used as main or final heaters for heating air or blowing air.

Easy to channel, especially when aqueous system heaters are unavailable they are quite useful devices with mounting possibilities.

* 70 110C and 110 70C (manual reset) safety as standard for all heaters thermostat.

Technical Drawing and Tables

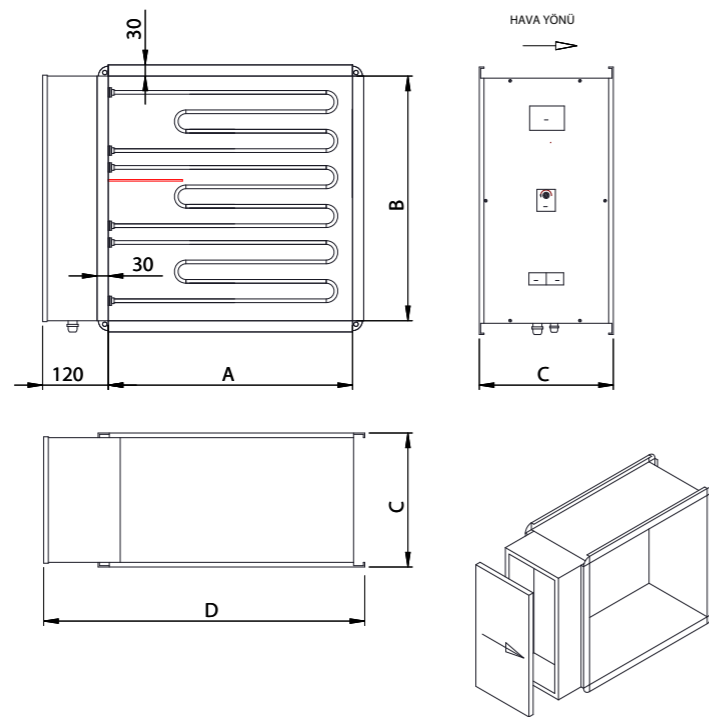

TYPE	A	B	C	D
BCTH 75	455	220	200	605
BCTH 100	455	270	200	605
BCTH 200	555	320	200	705
BCTH 300	555	380	200	705
BCTH 400	655	420	200	805
BCTH 500	855	520	200	1005

Dimensions are in (mm)

TYPE	VOLTAGE V	WEIGHT kg
BCTH 75	380	3
BCTH 100	380	3
BCTH 200	380	5
BCTH 300	380	8
BCTH 400	380	10
BCTH 500	380	13

Sound Level Measured from 3m distance in room condition.



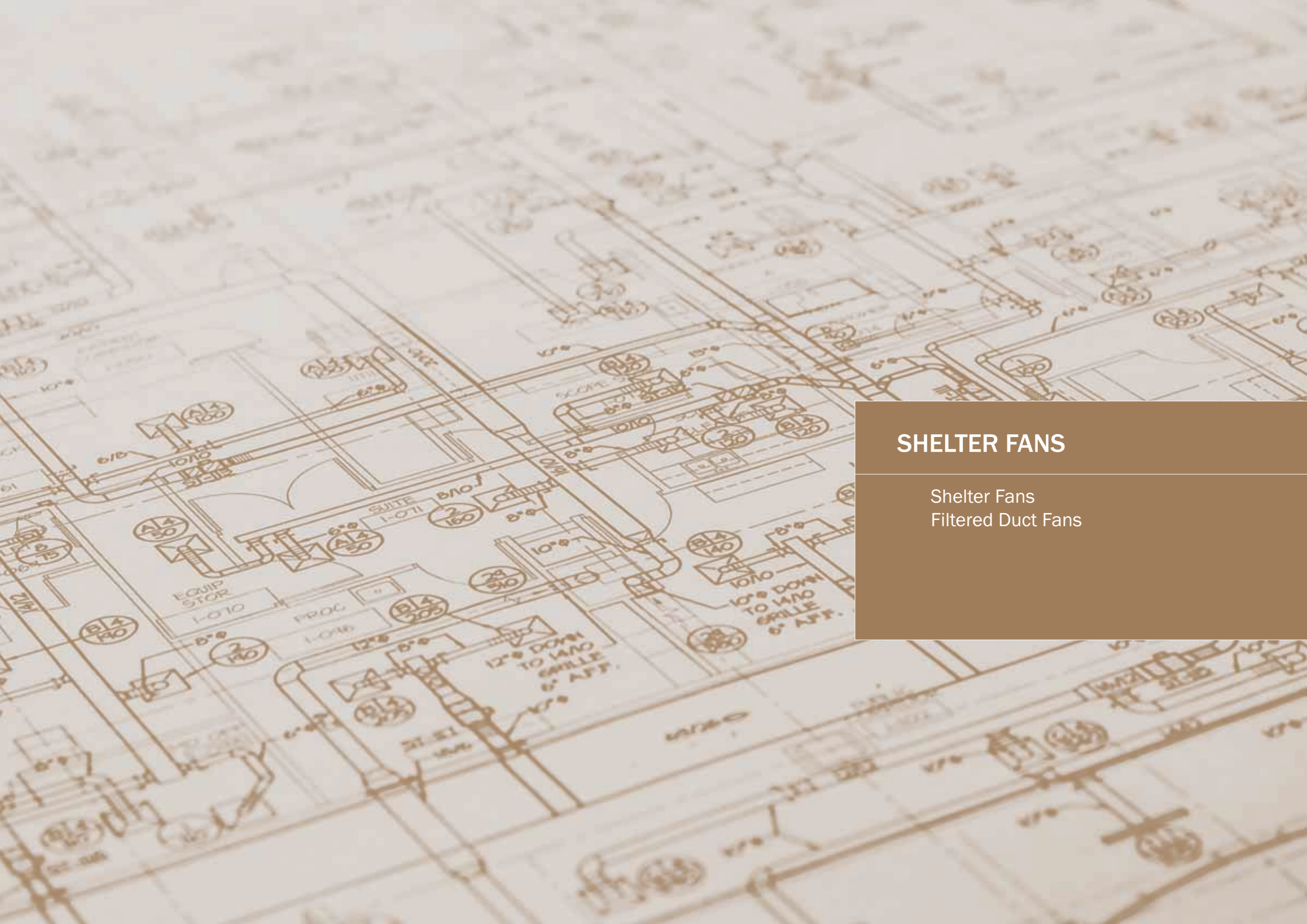

SHELTER FANS

Shelter Fans
Filtered Duct Fans

SHELTER FANS

BVN Shelter Fans are to provide the fresh air needed to indoors. These types can be used in two different positions: normal time and war time.

At normal time, fresh air only passes through G4 Filter and send air to the inner zones. At war time, the fresh air passes through the active carbon filter and nuclear Hepa filter to the inner zones with purifying the most of the possible chemical gases.

Due to our testings; bypass air dampers can not fully be sealed and efficient as much as bypass panels which are used in our devices.

It has been identified that bypass air damper is not fully sealed instead, it was seen that the bypass panel was more efficient in the tests and it was used in our devices.

SHELTER FAN TYPE

DUCT TYPE



CABINET TYPE





BSH

DUCT TYPE SHELTER FANS

Fan Components and Material Properties

The body is manufactured from galvanized sheet metal. Some of the BSH models are made of high quality galvanized steel which is resistant to corrosion and some models are made of aluminum material to meet their performance requirements. All models have an external rotor motor with closed structure. The device is capable of handling air at max.40°C.

Fan Structure

It is designed to work between the rectangular channel. The fan blades are aerodynamically curved and provide regular flow. The fans are composed of backward sloping and infrequently arranged fins.

Benefits

Bypass air dampers have been found not to be fully sealed. Instead, it is seen that the sliding sys-

tem bypass panel is more efficient in the tests and it has been used in our devices. It can be operated in the desired position.

Speed Control

Optional control devices can be provided. Speed control can be done with linear voltage regulator in 1~phase products (see BSC accessory). Speed control with frequency inverter can be done in 3~phase products (see BSC-F accessory)

Usage Areas

It is used for supplying fresh air to the shelters. They can be used in two different positions: normal time and war time. In normal time, the air is passed through the G4filter only to the interior. In the time of war, fresh air; It can be sent to the interior by passing through the activated carbon filter and nuclear hepa filter which can purify the possible chemical (nuclear) gases.

Technical Drawing and Tables

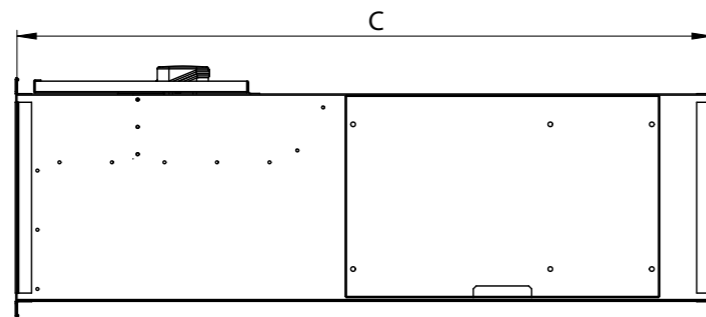
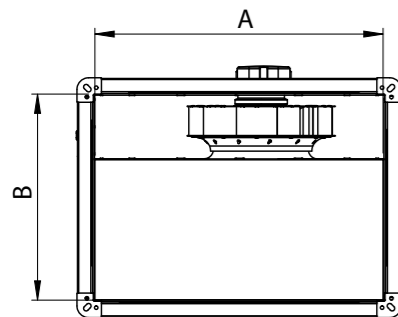

TYPE	A	B	C
BSH 40-25	400	250	1000
BSH 50-35A	500	350	1200
BSH 50-35B	500	350	1200
BSH 80-45A	800	450	1490
BSH 80-45B	800	450	1490
BSH 100-65A	1000	650	1750
BSH 100-65B	1000	650	1750

Dimensions are in (mm)

TYPE	VOLTAGE	FREQUENCY	POWER	CURRENT	CAPACITOR	SPEED	AIR FLOW	SOUND PRESSURE	INSULATION CLASS	PROTECTION CLASS	WEIGHT
TYPE	V	Hz	W	(A)	(µF)	r.p.m	m ³ /h	dB(A)	Ins.cl.	IP	kg
BSH 40-25	230	50	130	0,64	5	2675	400	50	B	44	28
BSH 50-35A	230	50	130	0,64	5	2675	650	52	B	44	53
BSH 50-35B	230	50	180	0,8	6	2635	750	55	B	44	55
BSH 80-45A	230	50	310	1,55	16	1430	1600	60	F	44	108
BSH 80-45B	230	50	500	2,5	18	1435	2200	62	F	44	112
BSH 100-65A	380	50	960	2	-	1350	3750	64	F	44	155
BSH 100-65B	380	50	1670	3	-	1350	4500	66	F	44	165

Sound Level Measured from 3m distance in room condition.

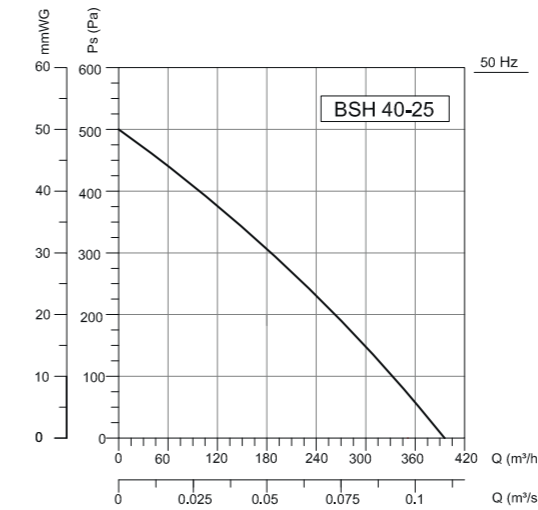

Frequency	Tot	63	125	250	500	1000	2000	4000	8000	Hz
L _{wa} Inlet	71	46	56	68	60	63	61	57	49	dB(A)
L _{wa} Outlet	74	46	55	69	66	65	68	63	60	dB(A)
L _{wa} Surrounding	57	22	36	55	47	46	46	40	37	dB(A)

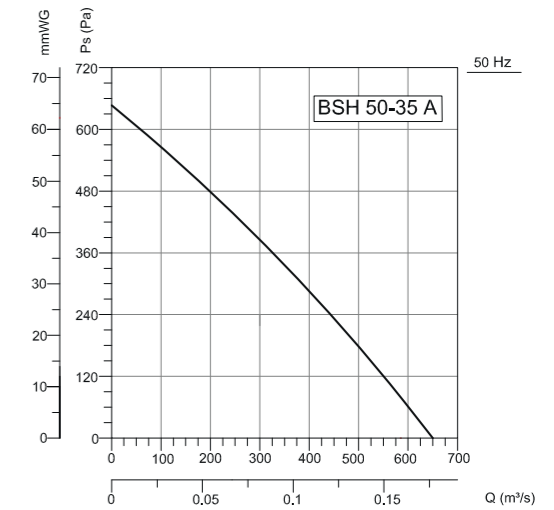

Frequency	Tot	63	125	250	500	1000	2000	4000	8000	Hz
L _{wa} Inlet	72	48	59	67	61	65	63	61	58	dB(A)
L _{wa} Outlet	76	49	59	68	67	68	71	65	67	dB(A)
L _{wa} Surrounding	59	29	33	53	52	52	53	45	43	dB(A)

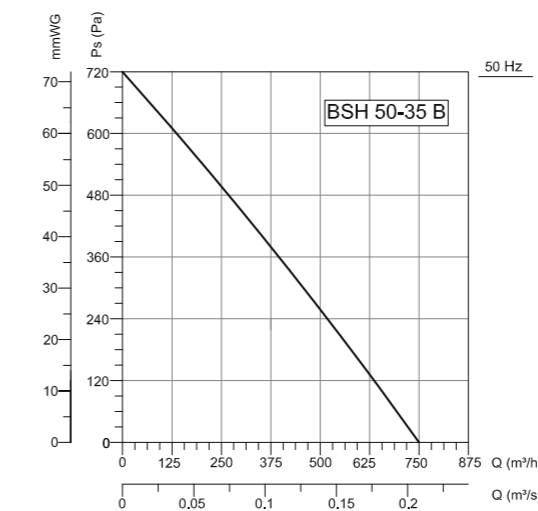

Frequency	Tot	63	125	250	500	1000	2000	4000	8000	Hz
L _{wa} Inlet	71	47	58	64	62	65	63	60	57	dB(A)
L _{wa} Outlet	75	48	58	66	68	68	70	64	67	dB(A)
L _{wa} Surrounding	62	30	37	56	54	56	55	47	44	dB(A)

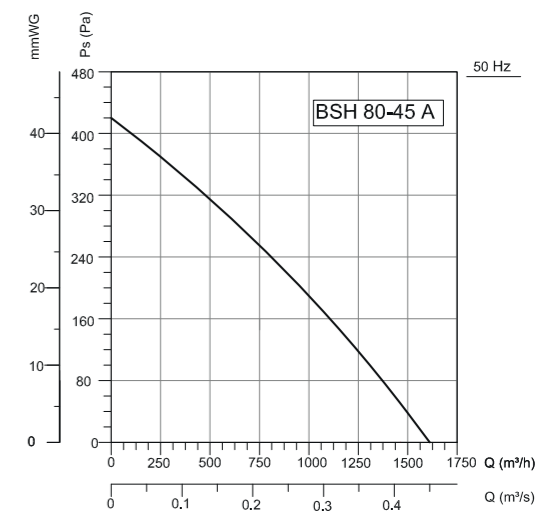

Frequency	Tot	63	125	250	500	1000	2000	4000	8000	Hz
L _{wa} Inlet	79	70	72	74	71	72	67	62	54	dB(A)
L _{wa} Outlet	82	59	70	75	78	75	73	68	56	dB(A)
L _{wa} Surrounding	67	45	57	64	62	57	54	49	42	dB(A)

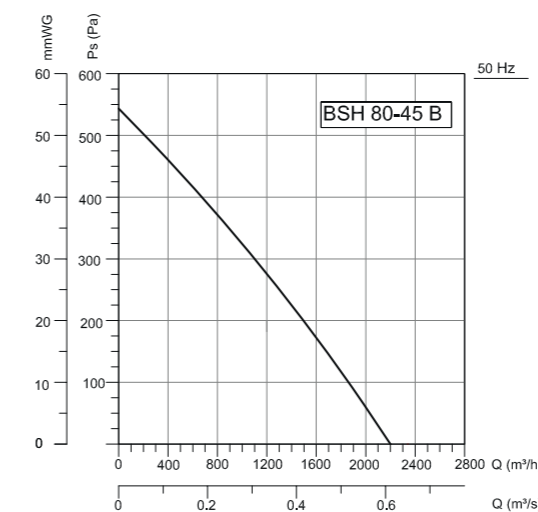

Frequency	Tot	63	125	250	500	1000	2000	4000	8000	Hz
L _{wa} Inlet	81	72	74	76	73	74	69	64	56	dB(A)
L _{wa} Outlet	84	61	72	77	80	77	75	70	58	dB(A)
L _{wa} Surrounding	69	47	59	66	64	59	56	51	44	dB(A)

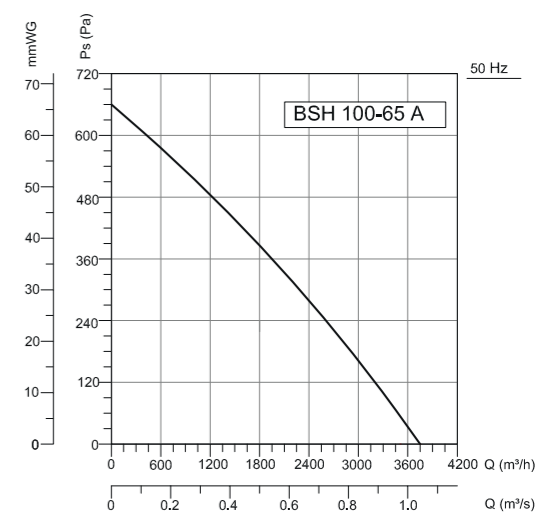

Frequency	Tot	63	125	250	500	1000	2000	4000	8000	Hz
L _{wa} Inlet	81	66	76	72	74	72	71	68	59	dB(A)
L _{wa} Outlet	86	66	77	78	80	79	77	73	54	dB(A)
L _{wa} Surrounding	71	47	69	65	60	59	54	47	41	dB(A)

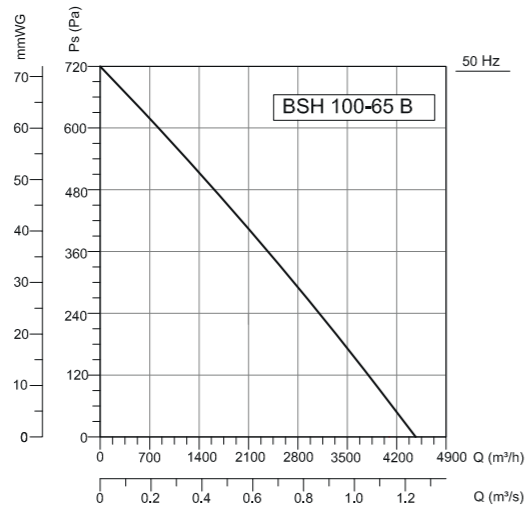

Frequency	Tot	63	125	250	500	1000	2000	4000	8000	Hz
L_{WA} Inlet	83	68	78	74	76	76	72	66	60	dB(A)
L_{WA} Outlet	87	72	78	80	81	81	79	71	65	dB(A)
L_{WA} Surrounding	73	50	70	67	62	61	56	48	45	dB(A)

Accessories

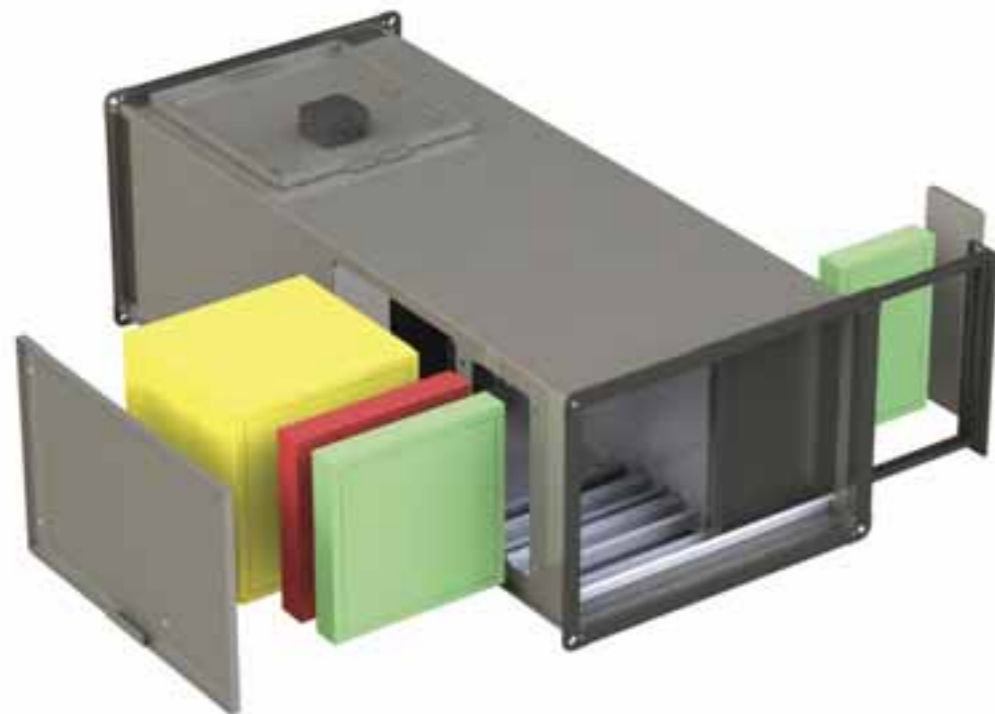

BSH-R

CABINET SHELTER FANS



Fan Components and Material Properties

The BSH-R double suction centrifugal box fan housing and fan are made of high quality galvanized steel that is resistant to corrosion. 25 mm stone wool was placed between the panels. Car-cass structure is made of aluminum profile. Asynchronous motor belt pulley drive system is used. The device is capable of handling air at max.40°C.

Fan Structure

Double suction, backward curved high pressure radial type fan. The fan wheel is manufactured from high strength resistant welded steel and streamlined to provide regular flow. Thanks to the suitable aerodynamic wing structure, it works silently.

Benefits

Rock wool insulation provides silence. The position damper is opened and the other damper is

switched off so that the position of the device is desired and the special damper is not used during normal use times.

Speed Control

Optional control devices can be provided. Speed control can be done with linear voltage regulator in 1~phase products (see BSC accessory). Speed control with frequency inverter can be done in 3~phase products (see BSC-F accessory)

Usage Areas

It is used for supplying fresh air to the shelters. They can be used in two different positions: normal time and war time. In normal time, the air is passed through the G4filter only to the interior. In the time of war, fresh air; It can be sent to the interior by passing through the activated carbon filter and nuclear hepa filter which can purify the possible chemical (nuclear) gases.

Technical Drawing and Tables

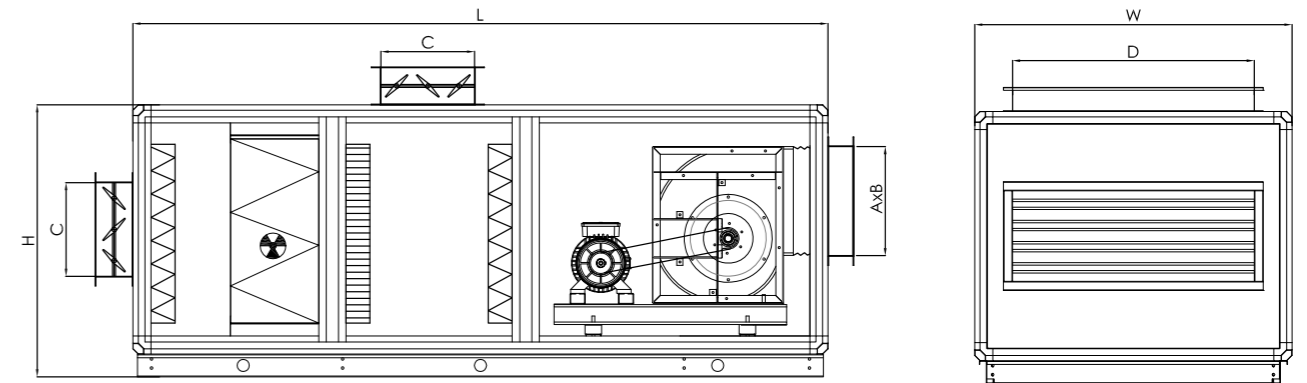

TYPE	H	W	L	A	B	C	D
BSH-R 280	825	750	1850	361	361	210	500
BSH-R 315	900	1050	2300	402	402	310	800
BSH-R 355	975	1340	2500	455	455	310	1090

Dimensions are in (mm)

TYPE	VOLTAGE	FREQUENCY	POWER	SPEED	AIR FLOW	EXTERNAL PRESSURE LOSS	INSULATION CLASS	PROTECTION CLASS
	V	Hz	kW	r.p.m	m³/h	Pa	Ins.cl.	IP
BSH-R 280-1,1	380	50	1,1	2552	2000	400	F	55
BSH-R 280-1,5	380	50	1,5	2613	3000	400	F	55
BSH-R 280-2,2	380	50	2,2	2809	4000	400	F	55
BSH-R 315-2,2	380	50	2,2	2451	5000	400	F	55
BSH-R 315-3	380	50	3	2591	6000	400	F	55
BSH-R 355-3	380	50	3	2251	7000	400	F	55
BSH-R 355-4	380	50	4	2354	8000	400	F	55

Sound Level Measured from 3m distance in room condition.

Accessories

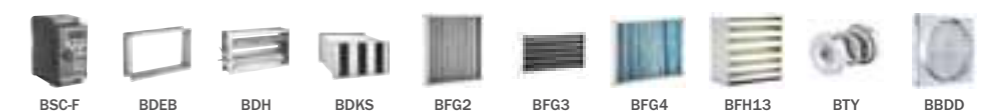



BSH-C

FILTERED DUCT FANS

Fan Components and Material Properties

Rectangular body is manufactured from galvanized steel sheet. The fans are made of high quality galvanized steel which is resistant to corrosion. All models have an external rotor motor with closed structure. The device is capable of handling air at max.40°C.

Fan Structure

The impeller consists of combining backward sloping and infrequently arranged fins.

Benefits

It can be operated in the desired position. Thanks to the bypass cell, it can be used in two

different positions. Bypass air damper is made by sliding system.

Speed Control

Optional control devices can be provided. Speed control can be done with linear voltage regulator in 1~phase products (see BSC accessory).

Usage Areas

It is used to supply fresh air. They can be used in two different positions; in normal time, the air is sent to the interior only through the G4 filter. When we want to clean the air, the G4 cassette filter is sent to the interior by passing through the M6 cassette filter which is more sensitive than the activated carbon cassette filter and coarse filter.

Technical Drawing and Tables

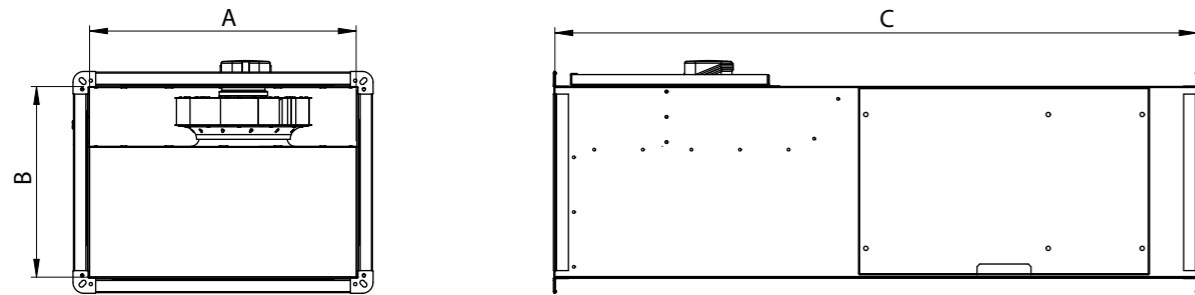
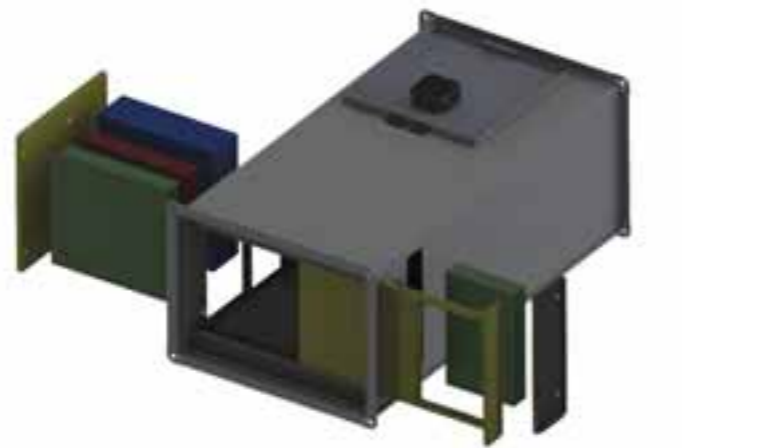

TYPE	A	B	C
BSH-C 40-20	400	200	800
BSH-C 50-25	500	250	1000
BSH-C 60-30	600	300	1100
BSH-C 70-35	700	350	1250

Dimensions are in (mm)

TYPE	VOLTAGE	FREQUENCY	POWER	CURRENT	CAPACITOR	SPEED	AIR FLOW	SOUND PRESSURE	INSULATION CLASS	PROTECTION CLASS	WEIGHT
	V	Hz	W	(A)	(µF)	r.p.m	m³/h	dB(A)	Ins.cl.	IP	kg
BSH-C 40-20	230	50	104	0,4	4	2800	500	48	B	44	24
BSH-C 50-25	230	50	130	0,8	5	2800	1000	50	B	44	35
BSH-C 60-30	230	50	180	0,64	6	2800	2000	53	B	44	45
BSH-C 70-35	230	50	210	0,96	6	1400	3000	45	B	44	63

Sound Level Measured from 3m distance in room condition.

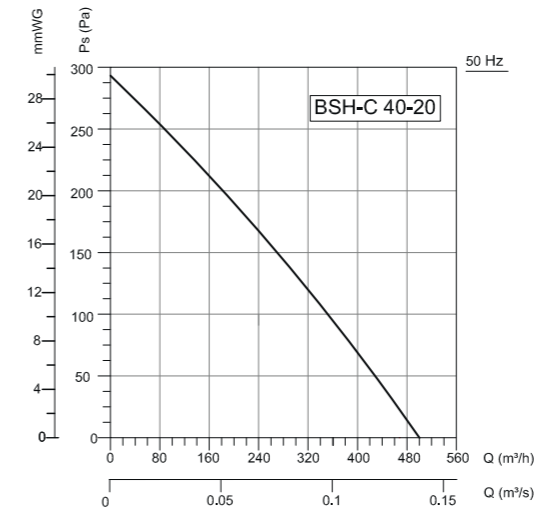

Frequency	Tot	63	125	250	500	1000	2000	4000	8000	Hz
L _{wa} Inlet	69	44	54	66	58	61	59	55	47	dB(A)
L _{wa} Outlet	72	44	53	67	64	63	66	61	58	dB(A)
L _{wa} Surrounding	55	20	34	53	45	44	44	38	35	dB(A)

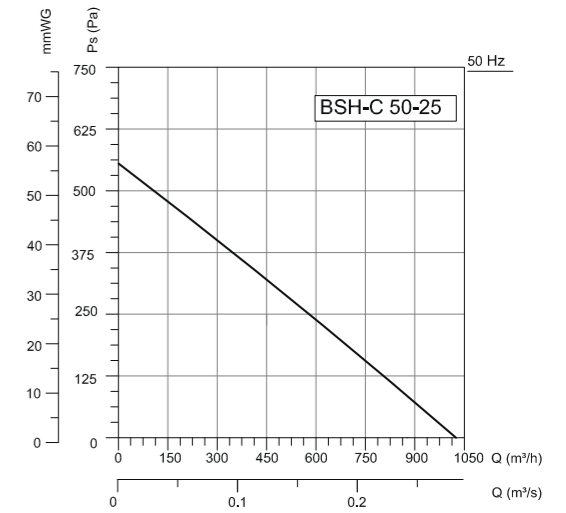

Frequency	Tot	63	125	250	500	1000	2000	4000	8000	Hz
L _{wa} Inlet	67	47	62	60	60	57	58	53	45	dB(A)
L _{wa} Outlet	73	51	69	65	66	65	64	59	51	dB(A)
L _{wa} Surrounding	57	24	54	50	47	46	45	46	34	dB(A)

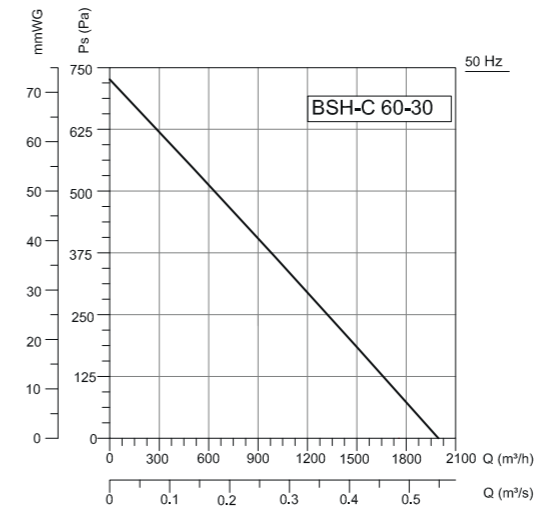

Frequency	Tot	63	125	250	500	1000	2000	4000	8000	Hz
L _{wa} Inlet	70	50	65	63	63	60	61	56	48	dB(A)
L _{wa} Outlet	76	54	72	68	69	68	67	62	54	dB(A)
L _{wa} Surrounding	60	27	57	53	50	49	48	49	37	dB(A)

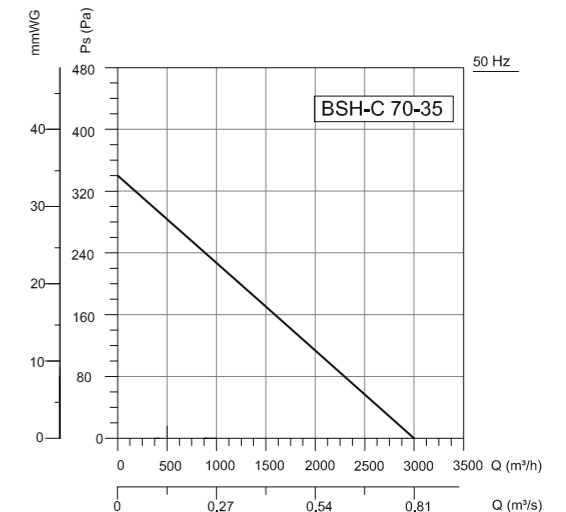

Frequency	Tot	63	125	250	500	1000	2000	4000	8000	Hz
L _{wa} Inlet	62	42	57	55	55	52	53	48	40	dB(A)
L _{wa} Outlet	68	46	64	60	61	60	59	54	46	dB(A)
L _{wa} Surrounding	52	19	49	45	42	41	40	41	29	dB(A)

Accessories



BSC BDEB BDH BDKS BFG2 BFG3 BFG4 BFH13 BCTH

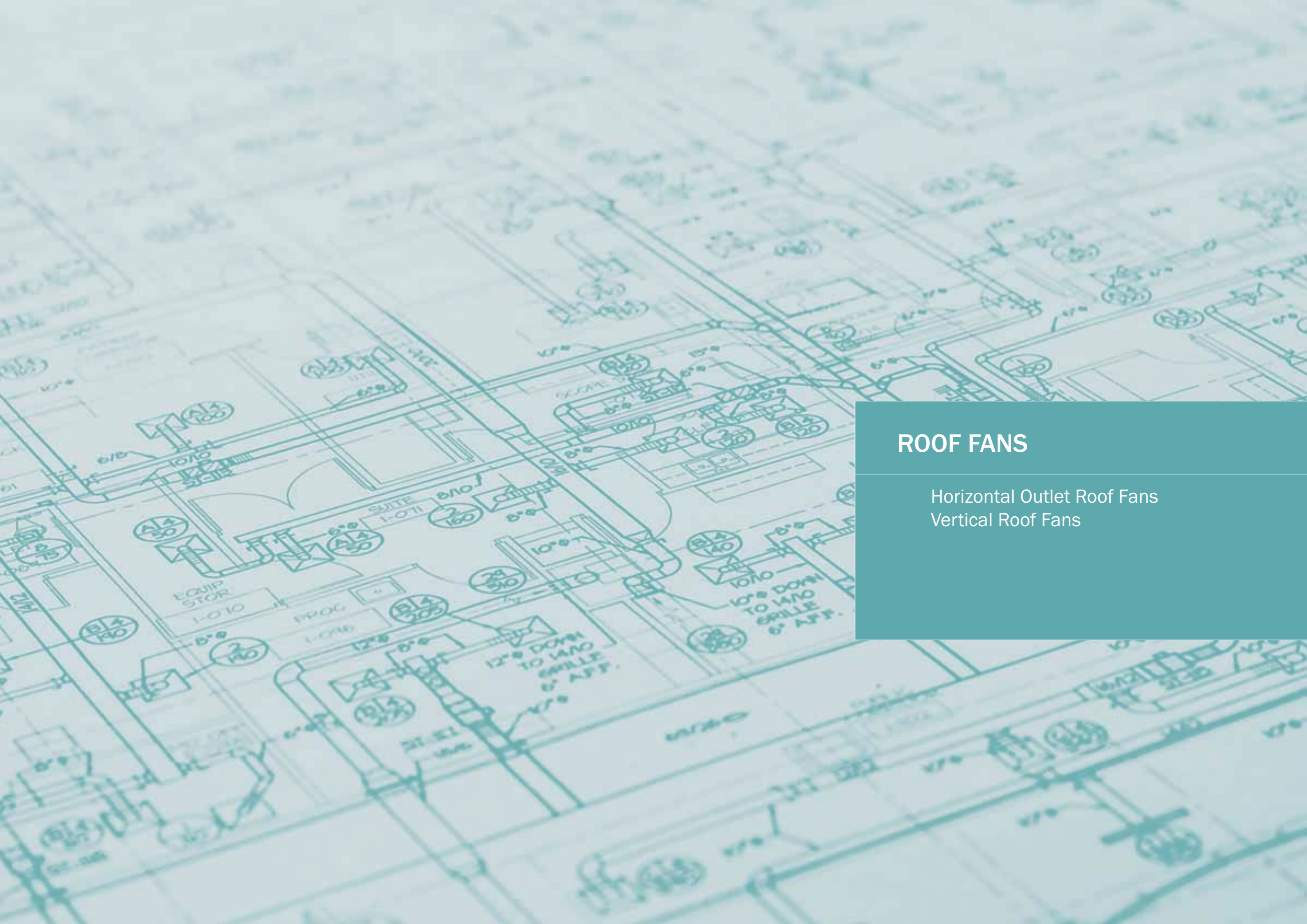

ROOF FANS

Horizontal Outlet Roof Fans
Vertical Roof Fans

ROOF FANS

Roof fans to be used for supplying or exhausting air on the roof based applications. BVN range is enough for different usage areas.

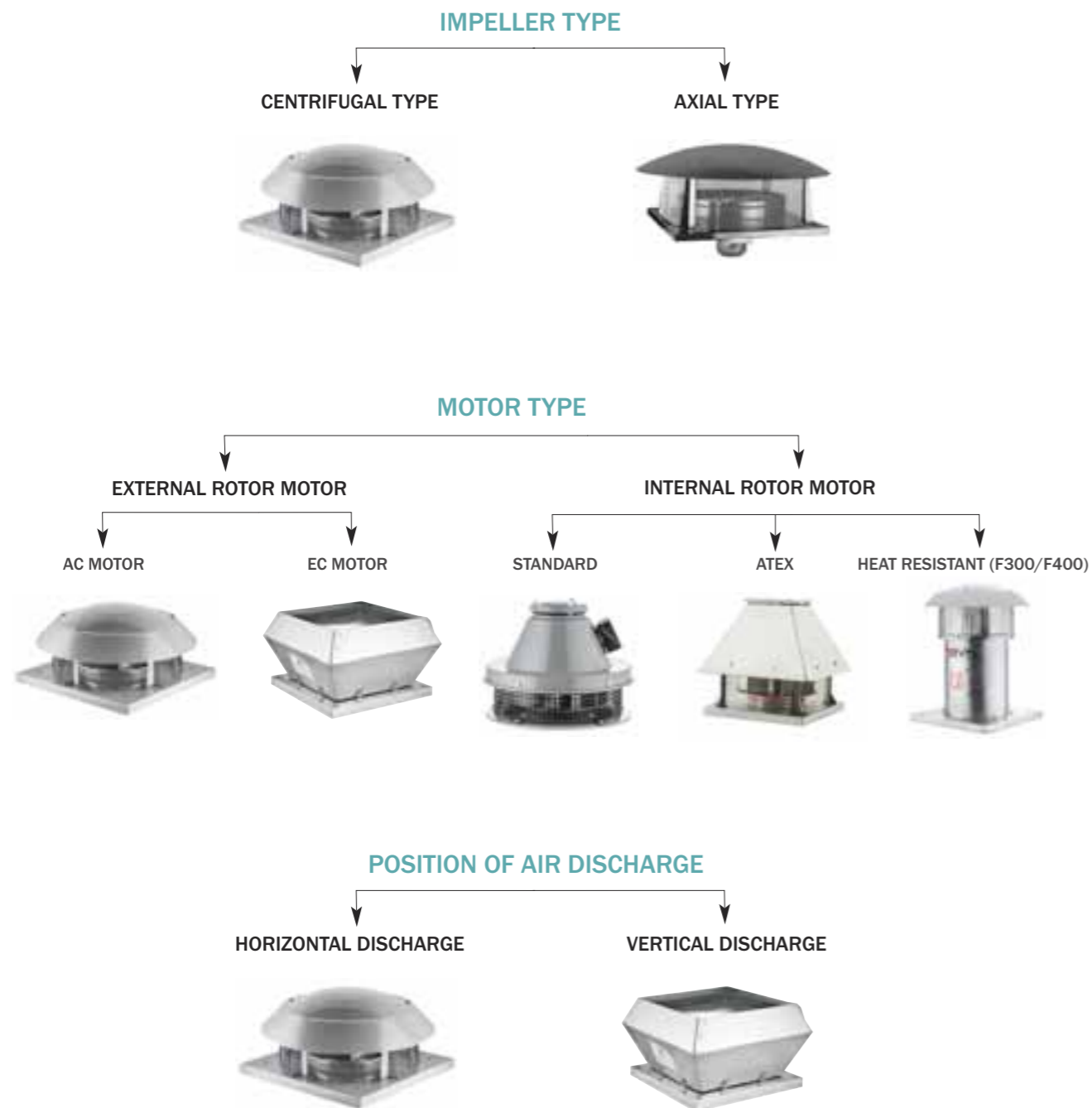



BRF

HORIZONTAL OUTLET ROOF FANS / Backward Curved

Fan Components and Material Properties

The mounting plate and fan cap of the BRF series horizontal discharge centrifugal fans are made of electrostatic powder coated sheet metal. The fan wheels of the models BRF 160-400 are made of high quality galvanized sheet steel which is resistant to corrosion. The fan wheels of the BRF 450-500-560 models are made of aluminum sheet. All models have an external rotor motor with closed structure. The device is capable of handling air at max.40°C.

Fan Structure

The fan blades are aerodynamically curved and provide regular flow. The fans are composed of backward sloping and infrequently arranged fins.

Benefits

Lightweight and compact housing for easy installation. Thanks to the aerodynamic wing structure, they work quietly. Speed can be adjusted with speed control devices.

Speed Control

Optional control devices can be provided. Speed control can be done with linear voltage regulator in 1~phase products (see BSC accessory). Speed control with frequency inverter can be done in 3~phase products (see BSC-F accessory)

Usage Areas

In order to improve the indoor air quality, BRF roof fans operate at low noise level with an external rotor motor. It is used on the roofs of the places where the air is to be refreshed and the chimneys on the roofs of the bathrooms and wc's which are opened to the common shaft of the buildings.

Technical Drawing and Tables

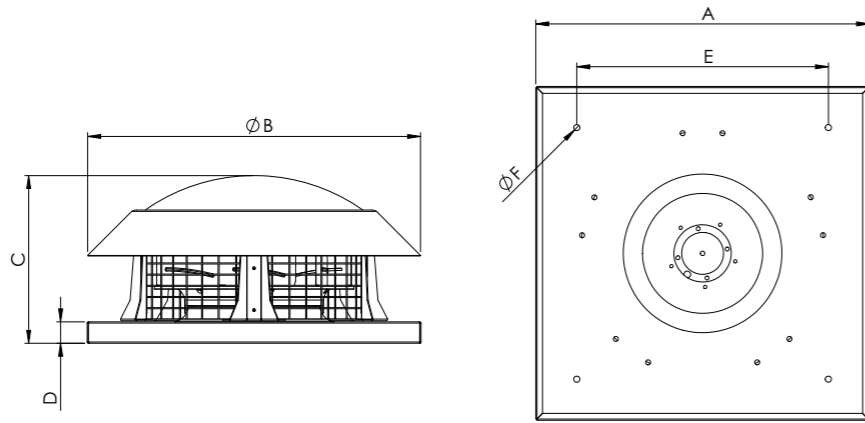

TYPE	A	B	C	D	E	F
BRF 160	252	260	140	25	210	6
BRF 180	252	260	140	25	210	6
BRF 225	336	386	212	35	274	11
BRF 250	370	386	225	35	290	11
BRF 315	454	443	293	40	333	11
BRF 355	595	595	285	40	450	11
BRF 400	595	685	355	40	450	12
BRF 450	664	685	400	40	450	12
BRF 500	798	824	385	40	600	12
BRF 560	798	824	400	40	600	12

Dimensions are in (mm)

TYPE	VOLTAGE	FREQUENCY	POWER	CURRENT	CAPACITOR	SPEED	AIR FLOW	SOUND PRESSURE	INSULATION CLASS	PROTECTION CLASS	WEIGHT
	V	Hz	W	(A)	(µF)	r.p.m	m ³ /h	dB(A)	Ins.cl.	IP	kg
BRF 160	230	50/60	60	0,3	2	2600/3000	346/400	44-36	B	44	3,5
BRF 180	230	50/60	70/90	0,35/0,43	2,5	2500/2750	460/500	49-41	B	44	3,7
BRF 225	230	50/60	80/100	0,40/0,50	3	2750/3100	902/1020	50-42	B	44	7
BRF 250	230	50/60	125/175	0,61/0,91	6	2800/3180	1212/1375	52-44	B	44	8
BRF 315	230	50/60	130/150	0,8	6	1450/1740	2000/2400	47-39	F	44	12,8
BRF 355	230	50/60	200/245	1,05	6	1400/1680	2900/3500	46-38	F	44	18
BRF 400	230	50/60	310/460	1,56/2,27	10	1380/1560	4100/4600	51-43	F	44	22
BRF 450	230	50/60	430/655	2,2/3,2	10	1370/1525	5400/6000	52-44	F	44	28
BRF 500	380 Δ/Y	50	840/580	1,95/1,12	-	1360/1100	7600/6150	54-46	F	44	45,5
BRF 560	380 Δ/Y	50	1440/840	2,8/1,6	-	1300/950	9800/7150	66-58	F	44	48

The sound level is measured at a distance of 4-10 m in open field condition.

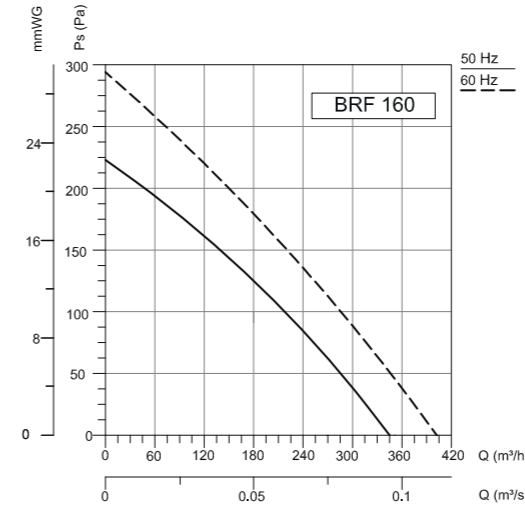

Frequency	Tot	63	125	250	500	1000	2000	4000	8000	Hz
L _{wa} Inlet	66	37	55	59	61	60	57	52	45	dB(A)
L _{wa} Surrounding	67	38	56	60	62	61	58	53	46	dB(A)

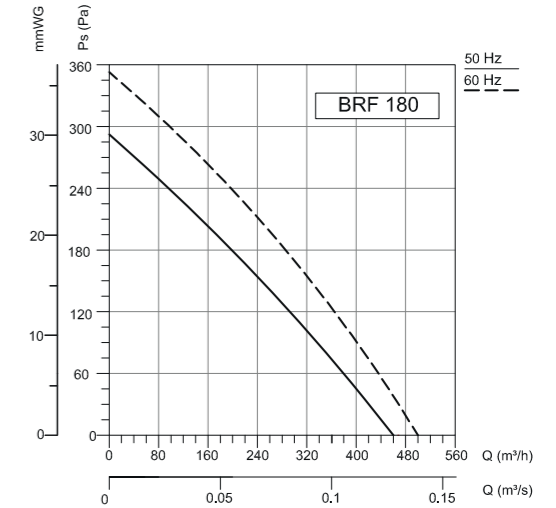

Frequency	Tot	63	125	250	500	1000	2000	4000	8000	Hz
L _{wa} Inlet	70	41	59	63	65	64	61	56	49	dB(A)
L _{wa} Surrounding	71	42	60	64	66	65	62	57	50	dB(A)

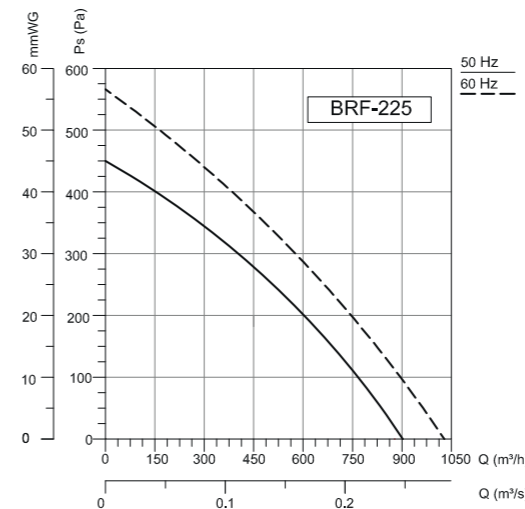

Frequency	Tot	63	125	250	500	1000	2000	4000	8000	Hz
L _{wa} Inlet	72	43	61	65	67	66	63	58	51	dB(A)
L _{wa} Surrounding	73	44	60	66	68	67	64	59	52	dB(A)

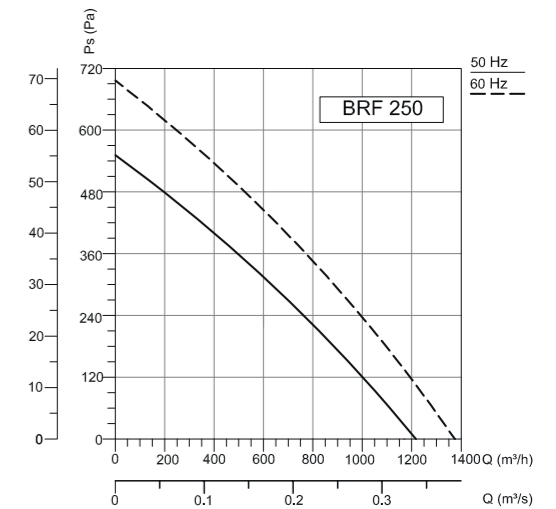

Frequency	Tot	63	125	250	500	1000	2000	4000	8000	Hz
L _{wa} Inlet	74	45	63	67	69	68	65	60	53	dB(A)
L _{wa} Surrounding	75	46	62	68	70	69	66	61	54	dB(A)

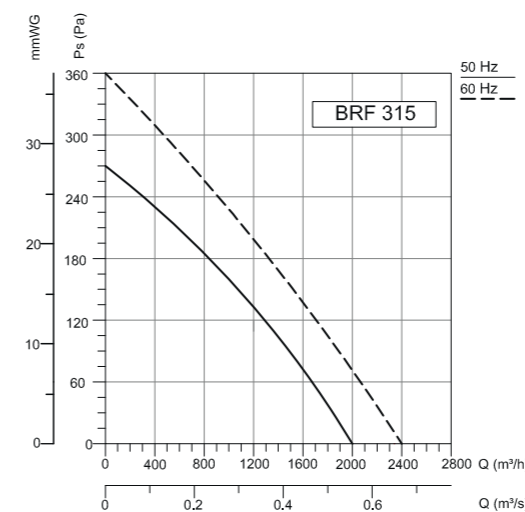

Frequency	Tot	63	125	250	500	1000	2000	4000	8000	Hz
L _{wa} Inlet	68	55	57	61	63	62	59	54	47	dB(A)
L _{wa} Surrounding	70	57	59	63	65	64	61	56	49	dB(A)

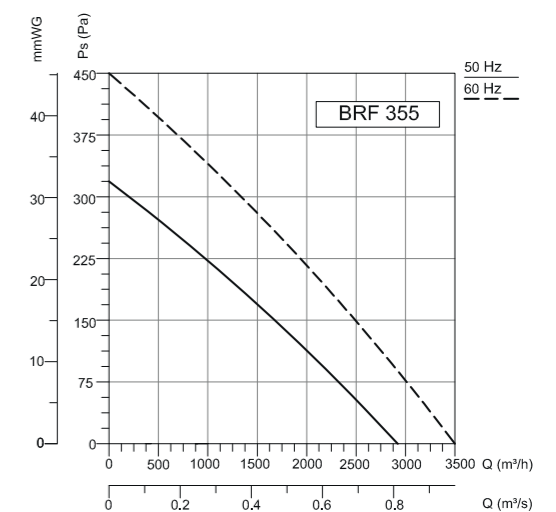

Frequency	Tot	63	125	250	500	1000	2000	4000	8000	Hz
L _{wa} Inlet	67	54	56	60	62	61	58	53	46	dB(A)
L _{wa} Surrounding	69	56	58	62	64	63	60	55	48	dB(A)

BRCF-M

HORIZONTAL OUTLET ROOF FANS / Backward Curved



Fan Components and Material Properties

Body and hat made of electrostatic powder coated sheet metal. The BRCF-M 280 fan is made of high quality galvanized steel that is resistant to corrosion. The motor is external rotor with closed structure and is out of the airflow. The device is capable of carrying air at max.120°C.

Fan Structure

The fan blades are aerodynamically curved and provide regular flow. The fans are composed of backward sloping and infrequently arranged fins. Thanks to its aerodynamic wing structure, it works quietly.

Benefits

BRCF-M roof fans provide a great advantage in applications with vertical throw feature, especially in conditions where horizontally aspirated air cannot be disposed of. Thanks to the aerodynamic wing

structure, they work quietly. Speed can be adjusted with speed control devices. Since the motor is out of airflow, it is resistant to high temperature.

Speed Control

Optional control devices can be provided. Speed control with linear voltage regulator. (see BSC accessory)

Usage Areas

Industrial and commercial areas; it provides excellent solutions for smoke evacuation ventilation systems, especially for applications where the air must be transported at higher temperatures. It is used for ventilation of indoor spaces and kitchen areas. Due to its high temperature resistance, it is recommended to use the steam which is absorbed from the hoods by means of oil filter.

Technical Drawing and Tables

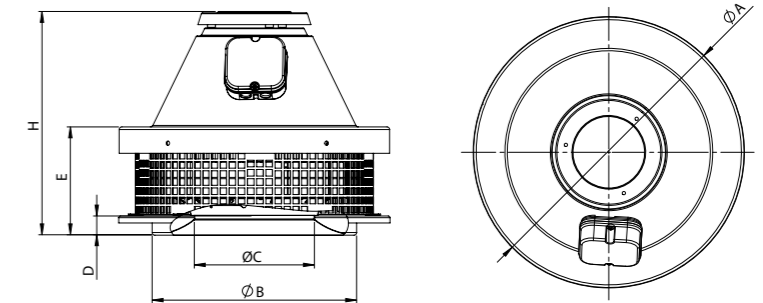

TYPE	A	B	C	D	E	H
BRCF-M 315	411	310	180	30	164	340

Dimensions are in (mm)

TYPE	VOLTAGE	FREQUENCY	POWER	CURRENT	CAPACITOR	SPEED	AIR FLOW	SOUND PRESSURE	INSULATION CLASS	PROTECTION CLASS	WEIGHT
	V	Hz	W	(A)	(µF)	r.p.m	m ³ /h	dB(A)	Ins.cl.	IP	kg
BRCF-M 315	230	50/60	185/280	0,82/1,23	5	2730/2980	1800/1965	56-48	F	44	11,3

The sound level is measured at a distance of 4-10 m in open field condition.

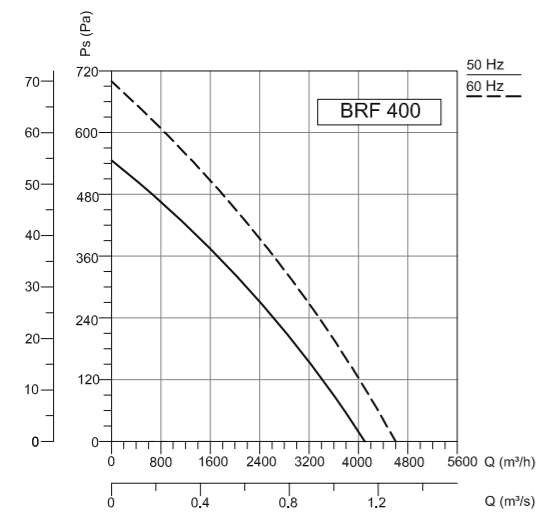

Frequency	Tot	63	125	250	500	1000	2000	4000	8000	Hz
L _{WA} Inlet	75	43	62	70	65	71	58	54	51	dB(A)
L _{WA} Surrounding	74	47	67	66	70	68	61	56	52	dB(A)

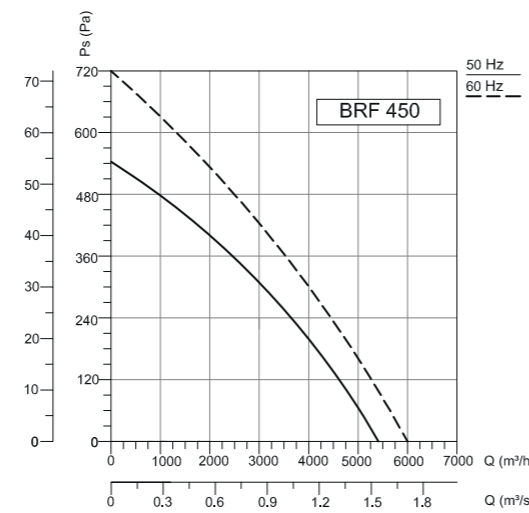

Frequency	Tot	63	125	250	500	1000	2000	4000	8000	Hz
L _{WA} Inlet	70	43	58	65	64	61	59	54	55	dB(A)
L _{WA} Surrounding	75	45	64	66	70	69	64	59	57	dB(A)

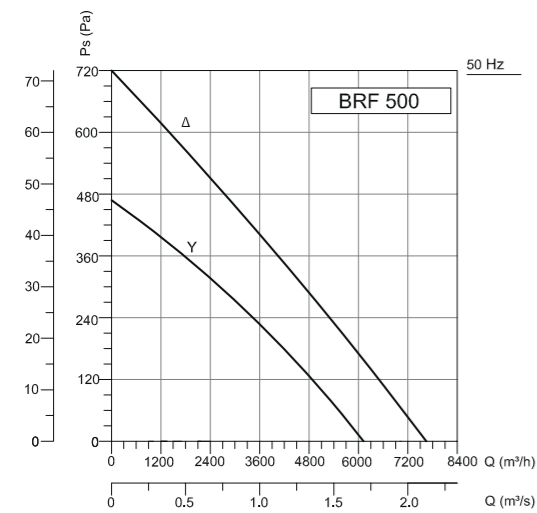

Frequency	Tot	63	125	250	500	1000	2000	4000	8000	Hz
L _{WA} Inlet	75	48	62	72	70	66	63	58	56	dB(A)
L _{WA} Surrounding	77	46	64	68	73	70	68	61	57	dB(A)

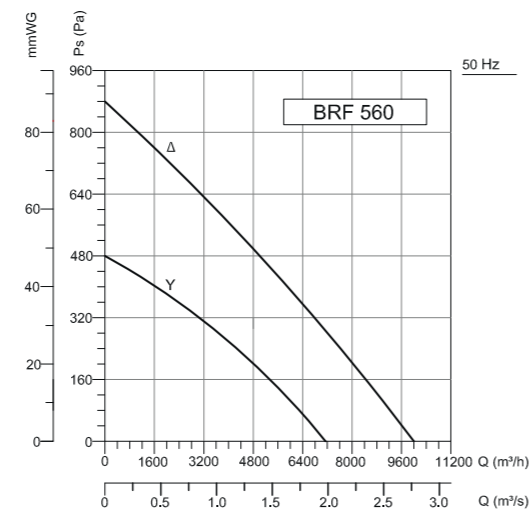

Frequency	Tot	63	125	250	500	1000	2000	4000	8000	Hz
L _{WA} Inlet	85	58	74	78	80	79	75	70	63	dB(A)
L _{WA} Surrounding	87	58	75	79	81	82	78	72	65	dB(A)

Accessories

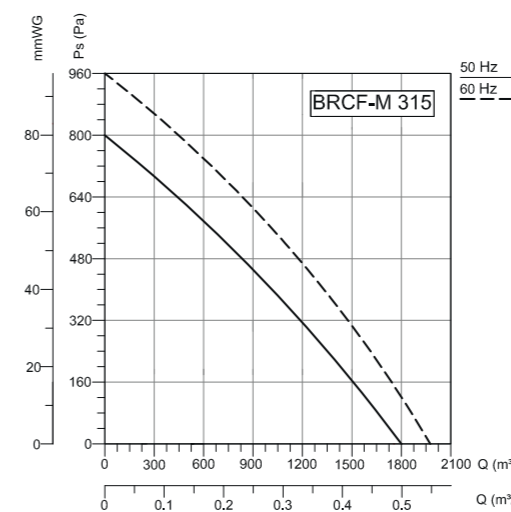

Frequency	Tot	63	125	250	500	1000	2000	4000	8000	Hz
L _{WA} Inlet	77	48	66	70	72	71	68	63	56	dB(A)
L _{WA} Surrounding	79	52	68	70	74	73	70	65	58	dB(A)

Accessories

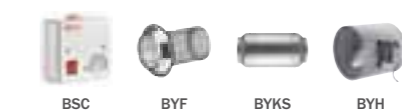



BRCF

HORIZONTAL OUTLET ROOF FANS / Backward Curved

Fan Components and Material Properties

BRCF series vertical centrifugal roof type radial fans Body, mounting plate and models of BRCF 280-400 fan impellers made of galvanized sheet steel, models of BRCF 450-560 fan impellers made of aluminum sheet and models BRCF 630-800 made of electrostatic powder coated sheet steel It was. Asynchronous motor is used in all models. The motor is out of airflow. The device is capable of carrying air at max.120°C.

Fan Structure

The fan blades are aerodynamically curved and provide regular flow. The fans are composed of backward sloping and infrequently aligned fins with the insertion technique, while the fan wheels of the models BRCF 630-800 are manufactured from the necessity of high strength.

Benefits

BRCF roof fans provide a great advantage in applications with vertical shot feature, especially in conditions where horizontal air is not absorbed.

Thanks to the aerodynamic wing structure, they work quietly. Speed can be adjusted with speed control devices. Since the motor is out of airflow, it is resistant to high temperature. Due to its high temperature resistance, the hot oil vapor absorbed from the hoods ensures a long distance to the vertical.

Speed Control

Optional control devices can be provided. Speed control with frequency inverter can be done in 3 ~ phase products (see BSC-F accessory)

Usage Areas

It is used in cases where air is needed to evacuate horizontally in order to increase the air quality of indoor spaces. BRCF roof fans operate at low volume with asynchronous norm motor. It is used in the roofs of the places where the air is to be refreshed, the chimneys on the bathroom and wc roofs of the buildings and the ventilation and hood system applications.

Technical Drawing and Tables

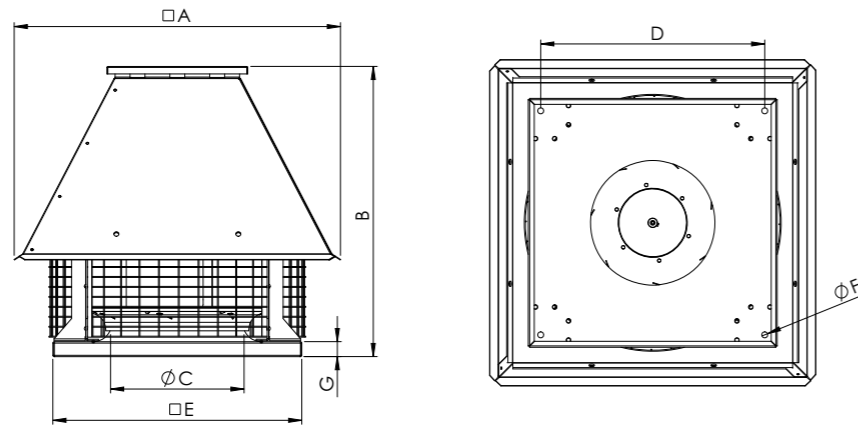

TYPE	A	B	C	D	E	F	G
BRCF 280	522	495	165	354	404	10	30
BRCF 315	595	555	198	404	454	10	30
BRCF 355	656	555	234	450	500	10	30
BRCF 400	656	585	268	450	500	12	30
BRCF 450	656	616	303	530	580	12	44
BRCF 500	766	660	342	590	640	12	44
BRCF 560	828	723	380	650	700	12	44
BRCF 630	997	922	445	660	730	12	54
BRCF 710	1095	991	500	710	780	12	54
BRCF 800	1205	1172	542	850	900	12	54

Dimensions are in (mm)

Accessories



BSC-F BYKS BYH

TYPE	VOLTAGE	FREQUENCY	POWER	CURRENT	CAPACITOR	SPEED	AIR FLOW	SOUND PRESSURE	INSULATION CLASS	PROTECTION CLASS	WEIGHT
	V	Hz	kW	(A)	(µF)	r.p.m	m³/h	dB(A)	Ins.cl.	IP	kg
BRCF 280M	230	50	0,25	2,1	10	1390	1000	53-45	F	55	35
BRCF 315M	230	50	0,25	2,1	10	1380	1950	53-45	F	55	42
BRCF 355M	230	50	0,25	2,1	10	1380	2900	55-47	F	55	50
BRCF 400M	230	50	0,37	3,4	15	1390	4000	60-52	F	55	55
BRCF 450M	230	50	0,55	4,5	20	1365	5550	62-54	F	55	62
BRCF 500M	230	50	1,1	7,5	35	1410	8300	64-56	F	55	68
BRCF 560M	230	50	2,2	14,2	50	1420	10800	66-58	F	55	75
BRCF 280T	380	50	0,25	0,87	-	1380	1000	53-45	F	55	35
BRCF 315T	380	50	0,25	0,87	-	1380	1950	53-45	F	55	42
BRCF 355T	380	50	0,25	0,87	-	1380	2900	55-47	F	55	50
BRCF 400T	380	50	0,37	1,2	-	1390	4000	60-52	F	55	55
BRCF 450T	380	50	0,55	1,6	-	1365	5550	62-54	F	55	62
BRCF 500T	380	50	1,1	2,6	-	1410	8300	64-56	F	55	68
BRCF 560T	380	50	2,2	4,9	-	1420	10800	66-58	F	55	75
BRCF 630T	380	50	3	6,6	-	1000	13000	60-52	F	55	127
BRCF 710T	380	50	4	8,4	-	1000	15000	63-55	F	55	150
BRCF 800T	380	50	7,5	15,4	-	1000	17000	67-59	F	55	216

The sound level is measured at a distance of 4-10 m in open field condition.

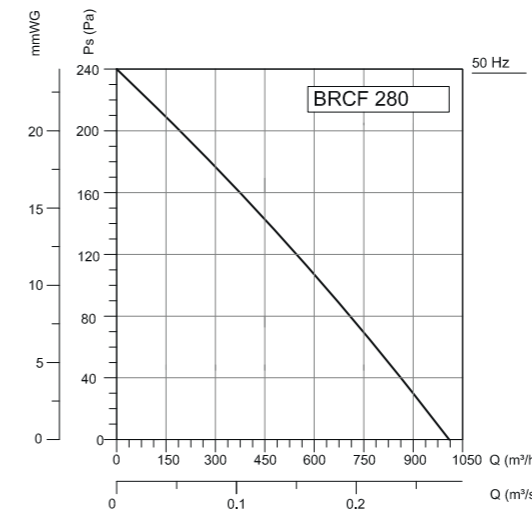

Frequency	Tot	63	125	250	500	1000	2000	4000	8000	Hz
L _{wa} Inlet	74	45	63	67	69	68	65	60	53	dB(A)
L _{wa} Surrounding	76	47	65	69	71	70	67	62	55	dB(A)

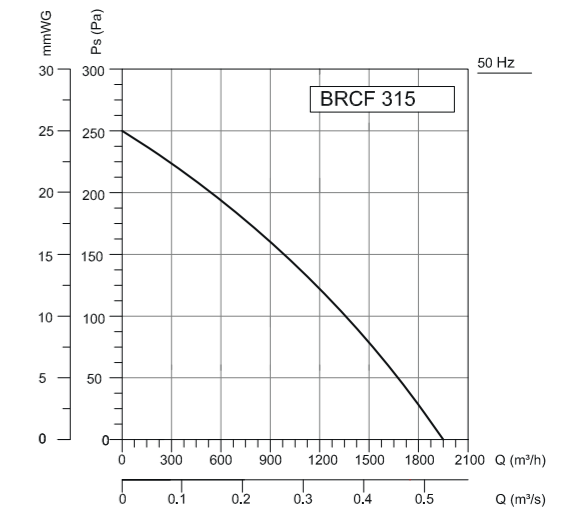

Frequency	Tot	63	125	250	500	1000	2000	4000	8000	Hz
L _{wa} Inlet	74	46	63	68	69	68	64	59	55	dB(A)
L _{wa} Surrounding	76	45	66	70	70	71	67	63	55	dB(A)

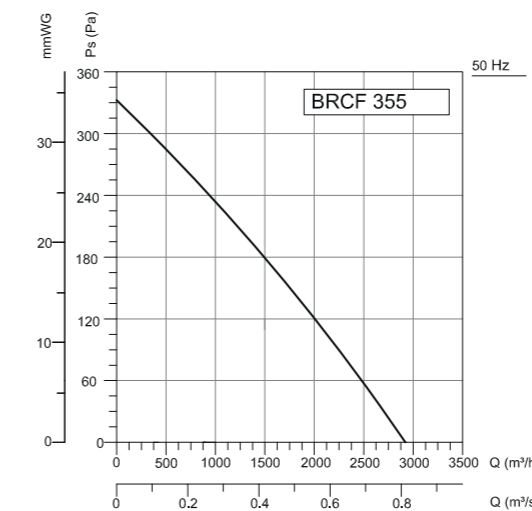

Frequency	Tot	63	125	250	500	1000	2000	4000	8000	Hz
L _{wa} Inlet	76	47	65	69	71	70	67	62	55	dB(A)
L _{wa} Surrounding	78	49	67	69	73	72	69	64	57	dB(A)

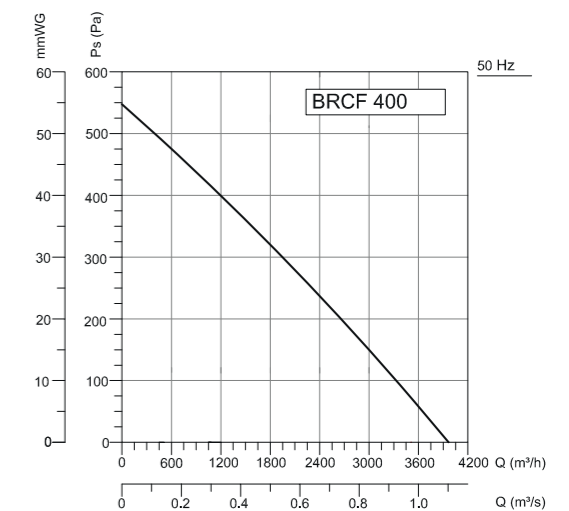

Frequency	Tot	63	125	250	500	1000	2000	4000	8000	Hz
L _{wa} Inlet	81	68	69	74	76	75	72	68	60	dB(A)
L _{wa} Surrounding	83	70	72	76	78	77	74	69	62	dB(A)



BACF

HORIZONTAL OUTLET ROOF FANS / Axial

Fan Components and Material Properties
Body, hat and protective wire cage are made of electrostatic powder coated steel. The motor and fan impeller are connected to the main body by steel carriers. The device is capable of handling air at max.40°C.

Fan Structure
The wings made of fiber glass composite materials are manufactured in airfoil structure to provide regular flow. Thanks to its aerodynamic wing structure, it works quietly.

Benefits
It works with low noise levels and is designed to be maintenance-free for long periods of time. Because of both suction and shooting capability, it is

possible to dispose of the polluted air in the environment and fresh air to the environment. Can be installed in the desired pain. Speed can be adjusted with speed control devices.

Speed Control
Optional control devices can be provided. 1~phase products with linear voltage regulator speed control can be done. BACF 560-630-710-800 models are excluded. (see BSC accessory)
Speed control can be done with frequency inverter in 3~phase products. (see BSC-F accessory)

Usage Areas
It is also used for ventilation of high volume factory, warehouse and hangar. It provides the ideal solution for large areas with its high flow rate.

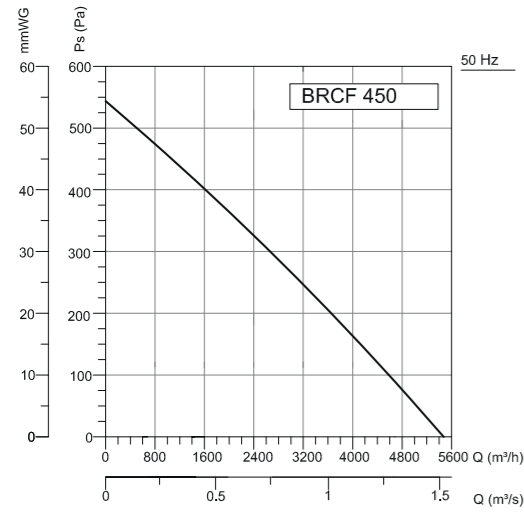

Frequency	Tot	63	125	250	500	1000	2000	4000	8000	Hz
L _{wa} Inlet	82	69	73	75	77	76	73	68	63	dB(A)
L _{wa} Surrounding	85	73	73	77	79	78	75	70	73	dB(A)

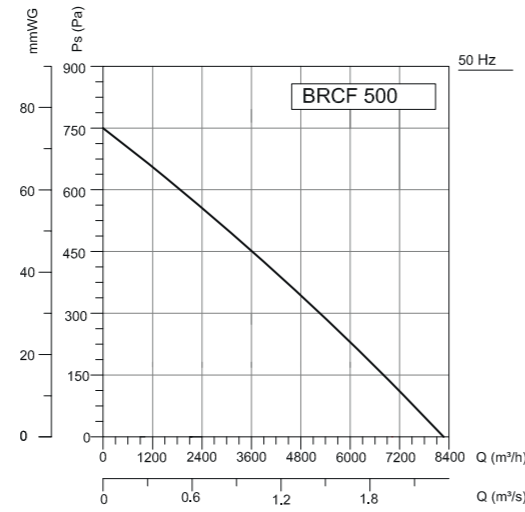

Frequency	Tot	63	125	250	500	1000	2000	4000	8000	Hz
L _{wa} Inlet	82	67	69	73	75	74	71	76	59	dB(A)
L _{wa} Surrounding	87	74	76	81	82	81	78	73	66	dB(A)

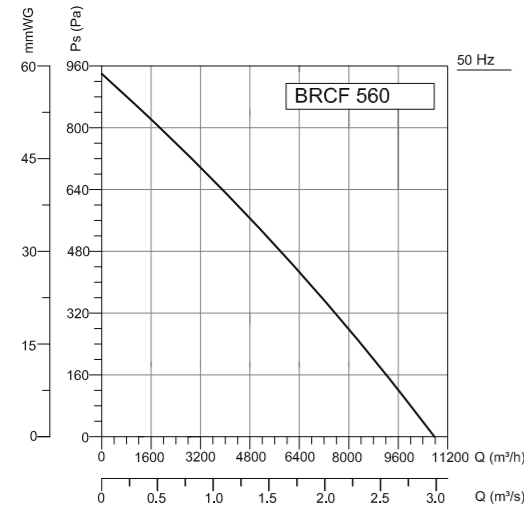

Frequency	Tot	63	125	250	500	1000	2000	4000	8000	Hz
L _{wa} Inlet	87	74	76	80	82	81	78	73	66	dB(A)
L _{wa} Surrounding	89	76	78	82	84	83	80	75	68	dB(A)

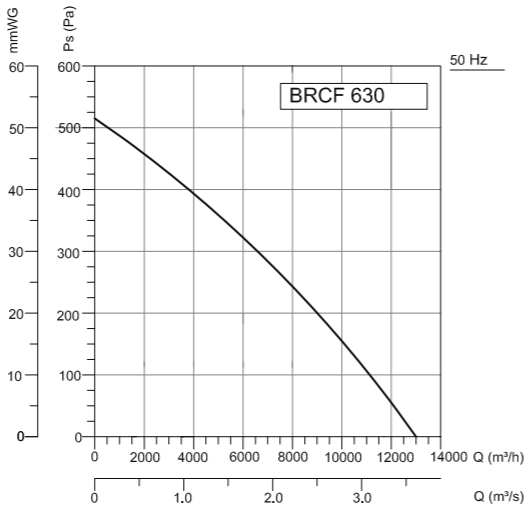

Frequency	Tot	63	125	250	500	1000	2000	4000	8000	Hz
L _{wa} Inlet	80	67	70	73	75	74	71	66	60	dB(A)
L _{wa} Surrounding	83	69	72	75	78	76	73	68	57	dB(A)

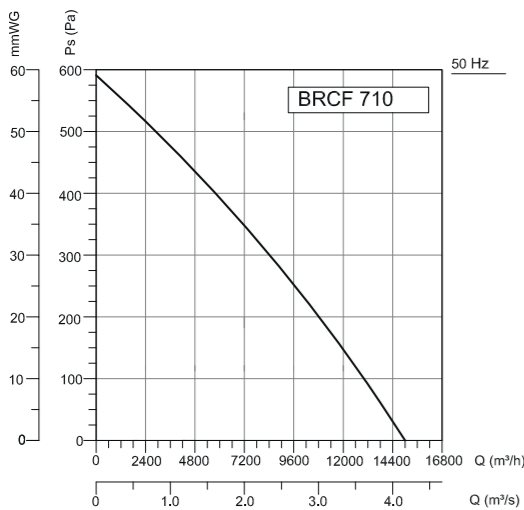

Frequency	Tot	63	125	250	500	1000	2000	4000	8000	Hz
L _{wa} Inlet	83	70	73	76	78	77	74	69	63	dB(A)
L _{wa} Surrounding	86	72	75	78	81	79	76	71	60	dB(A)

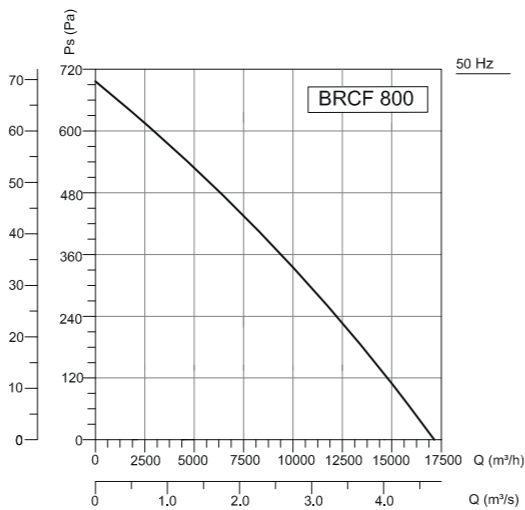

Frequency	Tot	63	125	250	500	1000	2000	4000	8000	Hz
L _{wa} Inlet	88	75	77	81	83	82	79	74	67	dB(A)
L _{wa} Surrounding	90	77	79	83	85	84	81	76	69	dB(A)

Technical Drawing and Tables

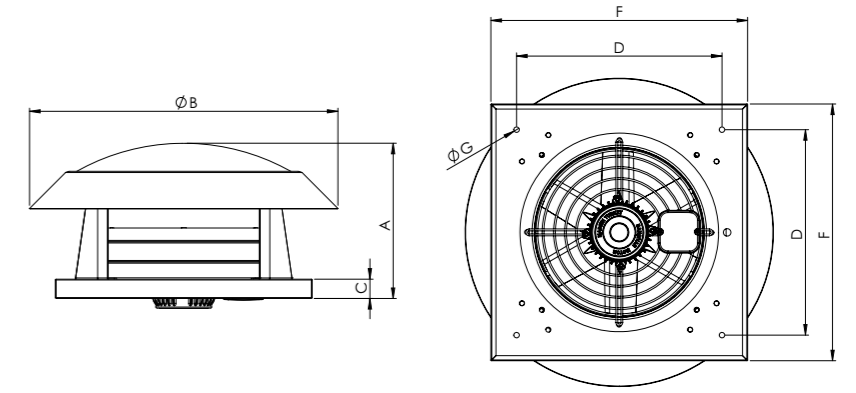

TYPE	A	B	C	D	F	G
BACF 300	340	685	40	450	560	12
BACF 350	340	685	40	450	560	12
BACF 400	470	824	40	530	630	12
BACF 450	480	824	40	590	710	12
BACF 500	480	824	40	680	740	12

Dimensions are in (mm)

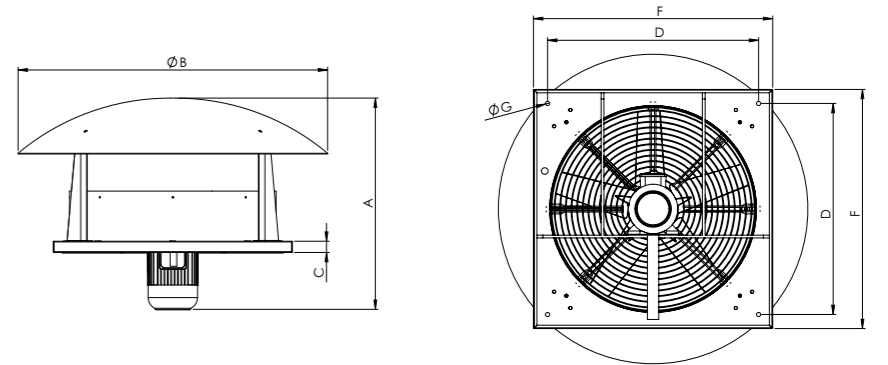

TYPE	A	B	C	D	F	G
BACF 560	710	1150	40	750	800	15
BACF 630	710	1150	40	750	850	15
BACF 710	800	1150	40	750	850	15
BACF 800	900	1450	40	900	1000	15
BACF 900	900	1450	40	900	1000	15
BACF 1000	950	1450	40	1000	1100	15

Dimensions are in (mm)

TYPE	VOLTAGE	FREQUENCY	POWER	CURRENT	CAPACITOR	SPEED	AIR FLOW	SOUND PRESSURE	INSULATION CLASS	PROTECTION CLASS	WEIGHT
	V	Hz	W	(A)	(μ F)	r.p.m	m ³ /h	dB(A)	Ins.cl.	IP	kg
BACF 300M	230	50/60	90/110	0,45/0,5	3	1445/1700	1800/2100	47-39	B	44	16
BACF 350M	230	50/60	250/310	1,22/1,38	6	1400/1550	2600/2880	48-40	B	44	18
BACF 400M	230	50/60	255/310	1,24/1,39	6	1375/1500	4500	51-43	B	44	20
BACF 450M	230	50/60	325/390	1,5/1,8	8	1350/1550	6500/7460	55-47	B	44	25
BACF 500M	230	50/60	375/480	1,75/2,15	12	1350	8500	57-49	B	44	30
BACF 300T	380	50	210	1,1	-	1445	1800	47-39	B	44	16
BACF 350T	380	50	270	1,3	-	1400	2600	48-40	B	44	18
BACF 400T	380	50/60	255/320	0,8/0,76	-	1375/1600	4500	51-43	B	44	20
BACF 450T	380	50	360	1,6	-	1240	6500	55-47	B	44	25
BACF 500T	380	50/60	370/450	0,84/0,88	-	1260	8500	57-49	B	44	30
TYPE	V	Hz	kW	(A)	(μF)	r.p.m	m³/h	dB(A)	Ins.cl.	IP	kg
BACF 560M	230	50	0,75	4,6	-	1405	10400	61-53	F	55	37
BACF 630M	230	50	1,1	7,1	-	1410	14000	63-55	F	55	45
BACF 710M	230	50	1,5	9,3	-	1410	18000	68-60	F	55	53
BACF 800M	230	50	2,2	13,4	-	1425	26000	70-62	F	55	75
BACF 560T	380	50	0,75	2,1	-	1405	10400	61-53	F	55	37
BACF 630T	380	50	1,1	2,6	-	1410	14000	63-55	F	55	45
BACF 710T	380	50	1,5	3,5	-	1410	18000	68-60	F	55	53
BACF 800T	380	50	2,2	5,0	-	1425	26000	70-62	F	55	75
BACF 900T	380	50	3	6,6	-	1425	32000	74-66	F	55	80
BACF 1000T	380	50	5,5	8,4	-	1440	42000	77-69	F	55	105

The sound level is measured at a distance of 4-10 m in open field condition.

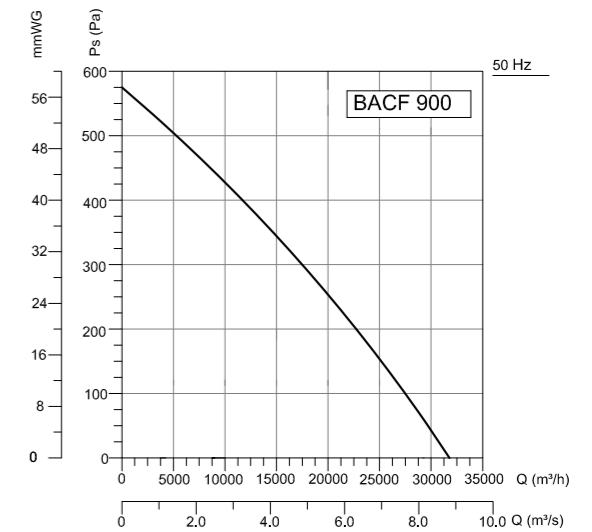
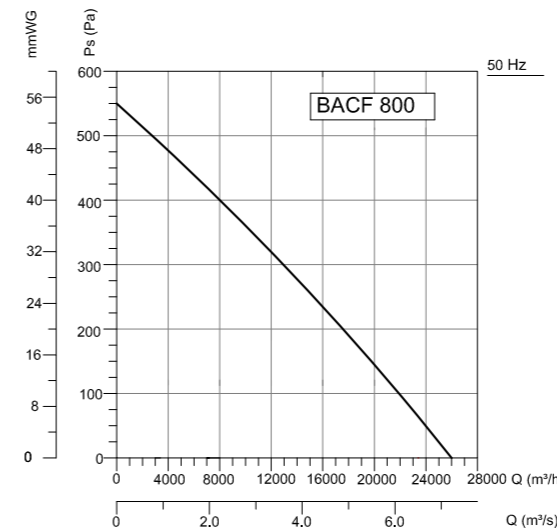
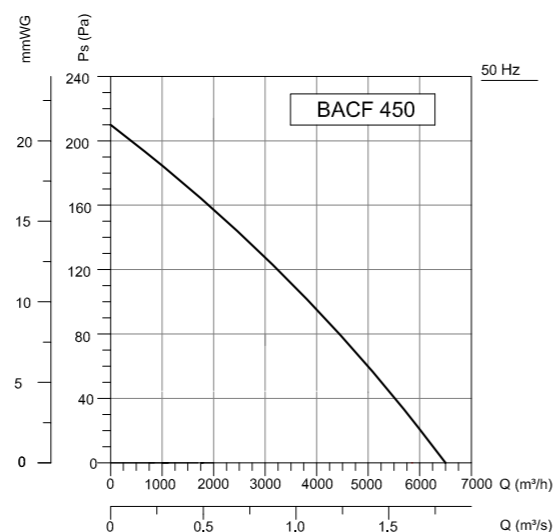
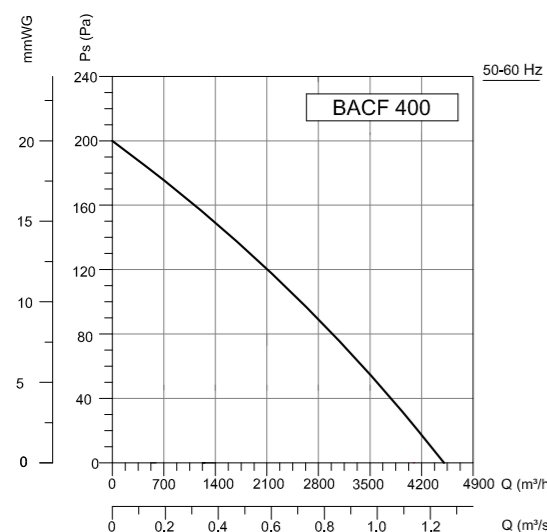
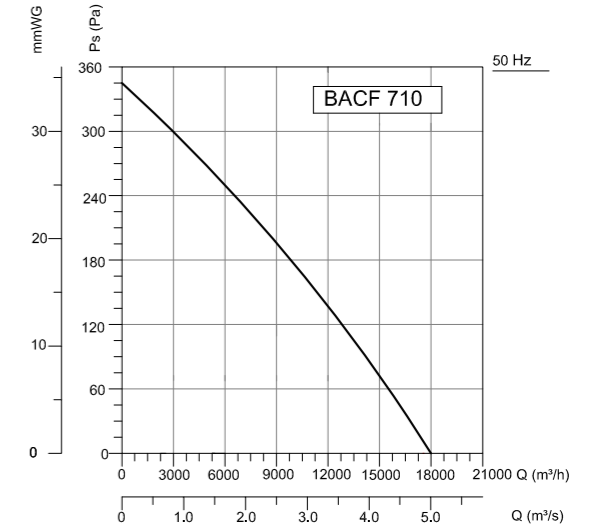
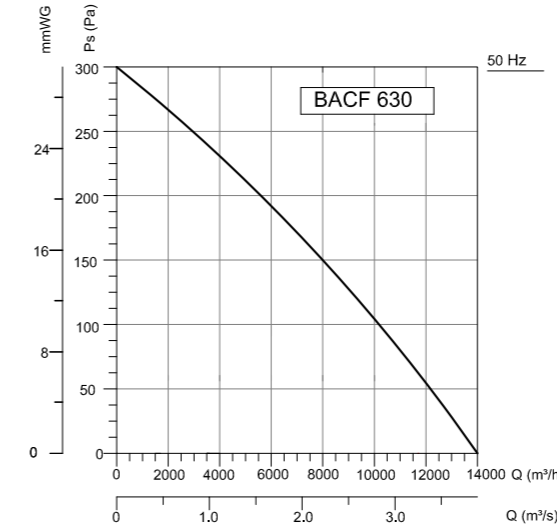
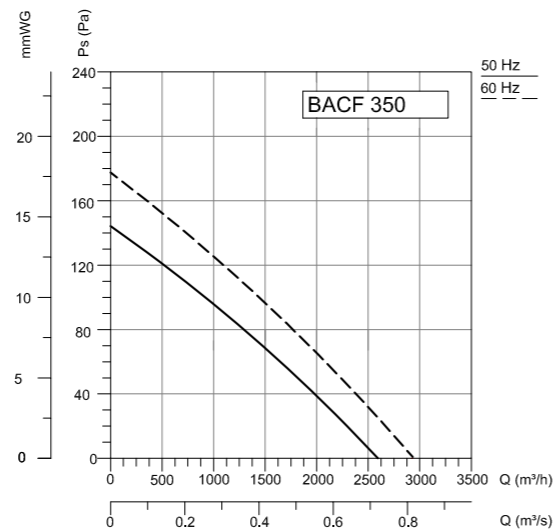
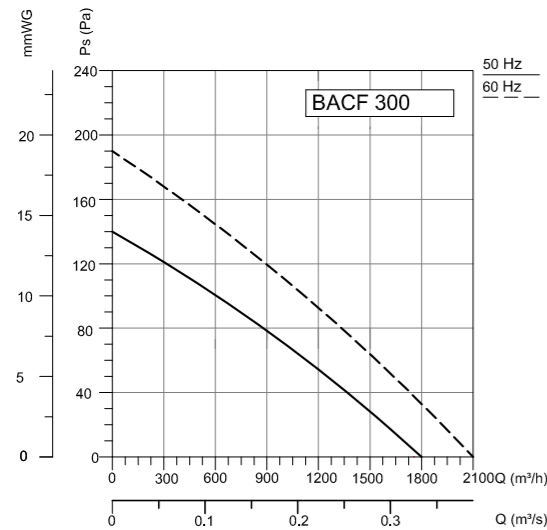
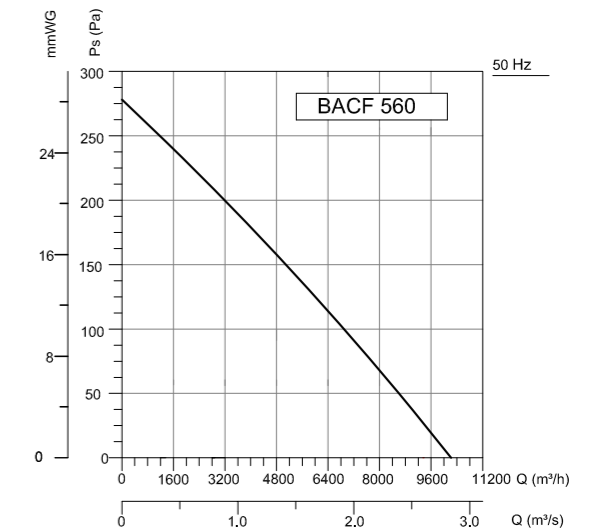
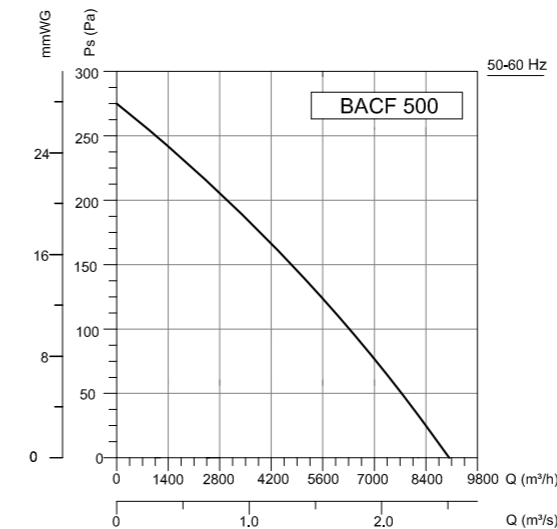

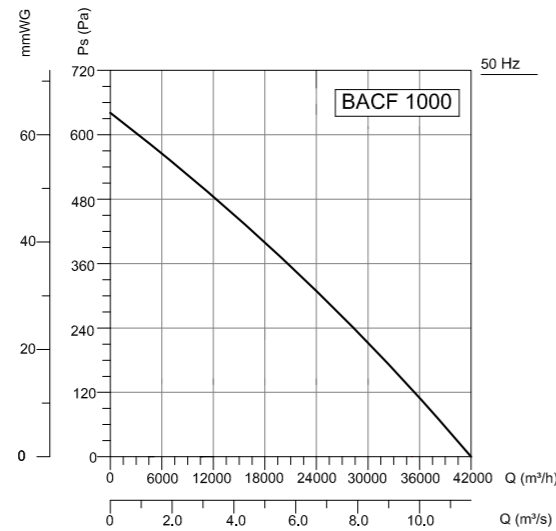

Accessories

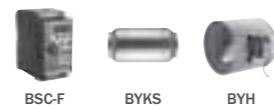

BRCF-EX PROOF

HORIZONTAL OUTLET ROOF FANS / Backward Curved

Fan Components and Material Properties

BRCF series vertical flush roof centrifugal fans Body, mounting plate and models of BRCF-EX 280-400 fan impellers made of galvanized sheet steel Made of powder coated sheet steel. The suction funnel is brass plated. Asynchronous ex-proof motor is used in all models. The motor is out of airflow. The device is capable of carrying air at max.120°C.

Fan Structure

The fan blades are aerodynamically curved and provide regular flow. The fans are composed of backward sloping and infrequently aligned fins with the insertion technique, while the fan wheels of the models BRCF 630-800 are manufactured from the necessity of high strength. Direct drive, backward curved and sparse blade

Benefits

BRCF roof fans provide a great advantage in applications with vertical shot feature, especially in conditions where horizontal air is not absorbed.

Thanks to the aerodynamic wing structure, they work quietly. Speed can be adjusted with speed control devices. Since the motor is out of airflow, it is resistant to high temperature. Due to its high temperature resistance, the hot oil vapor absorbed from the hoods ensures a long distance to the vertical. The motor's ex-proof feature ensures safe exhaustion of air in hazardous environments due to the fact that the aluminum and copper parts in the housing prevent electrostatic precipitation.

Speed Control

Optional control devices can be provided. Speed control with frequency inverter can be done in 3-phase products (see BSC-F accessory)

Usage Areas

Ex-proof fans or ex-proof fans are one of the preferred fan types for the ventilation of high-risk environments. It is designed to be non-sparking. Usage areas are determined according to the degree of Atex directive.

Technical Drawing and Tables

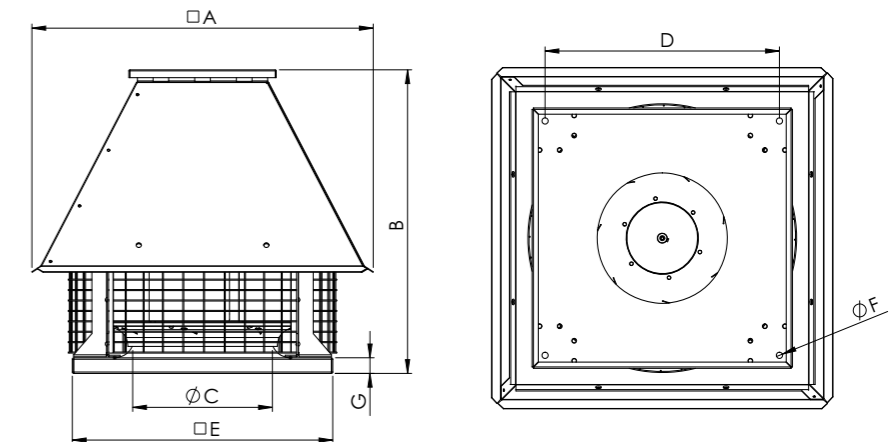

TYPE	A	B	C	D	E	F	G
BRCF-EX 280T	522	495	165	354	404	10	30
BRCF-EX 315T	595	555	198	404	454	10	30
BRCF-EX 355T	656	555	234	450	500	10	30
BRCF-EX 400T	656	585	268	450	500	12	30
BRCF-EX 450T	656	616	303	530	580	12	44
BRCF-EX 500T	766	660	342	590	640	12	44
BRCF-EX 560T	828	723	380	650	700	12	44
BRCF-EX 630T	997	922	445	660	730	12	54
BRCF-EX 710T	1095	991	500	710	780	12	54
BRCF-EX 800T	1205	1172	542	850	900	12	54

Dimensions are in (mm)

Accessories

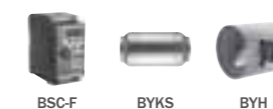

TYPE	VOLTAGE	FREQUENCY	POWER	CURRENT	SPEED	AIR FLOW	SOUND PRESSURE	INSULATION CLASS	PROTECTION CLASS	WEIGHT
	V	Hz	kW	(A)	r.p.m	m ³ /h	dB(A)	Ins.cl.	IP	kg
BRCF-EX 280T	380	50	0,25	0,87	1380	1000	53-45	F	55	35
BRCF-EX 315T	380	50	0,25	0,87	1380	1950	53-45	F	55	42
BRCF-EX 355T	380	50	0,25	0,87	1380	2900	55-47	F	55	50
BRCF-EX 400T	380	50	0,37	1,2	1390	4000	60-52	F	55	55
BRCF-EX 450T	380	50	0,55	1,6	1365	5550	62-54	F	55	62
BRCF-EX 500T	380	50	1,1	2,6	1410	8300	64-56	F	55	68
BRCF-EX 560T	380	50	2,2	4,9	1420	10800	66-58	F	55	75
BRCF-EX 630T	380	50	3	6,6	1000	13000	60-52	F	55	127
BRCF-EX 710T	380	50	4	8,4	1000	15000	63-55	F	55	150
BRCF-EX 800T	380	50	7,5	15,4	1000	17000	67-59	F	55	216

Sound Level Measured from 3m distance in room condition.

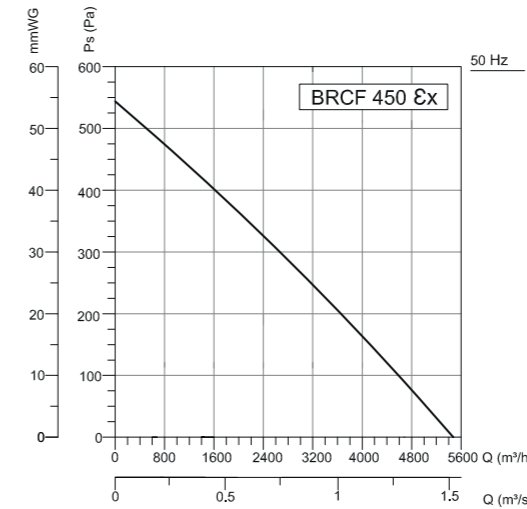

Frequency	Tot	63	125	250	500	1000	2000	4000	8000	Hz
L _{WA} Inlet	82	69	73	75	77	76	73	68	63	dB(A)
L _{WA} Surrounding	85	73	73	77	79	78	75	70	73	dB(A)

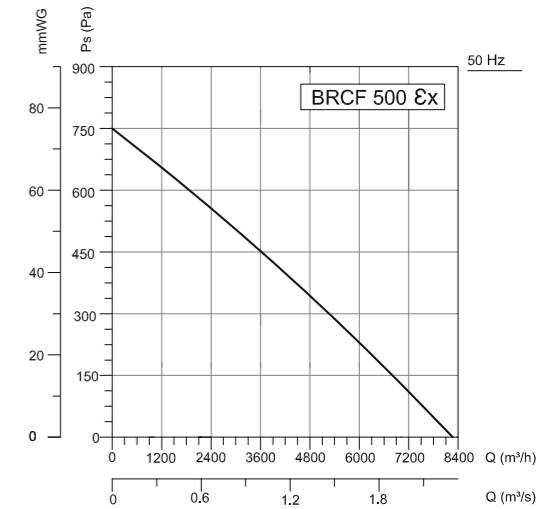

Frequency	Tot	63	125	250	500	1000	2000	4000	8000	Hz
L _{WA} Inlet	82	67	69	73	75	74	71	76	59	dB(A)
L _{WA} Surrounding	87	74	76	81	82	81	78	73	66	dB(A)

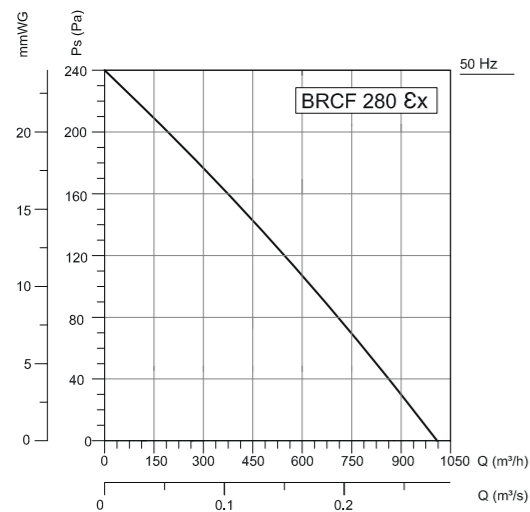

Frequency	Tot	63	125	250	500	1000	2000	4000	8000	Hz
L _{WA} Inlet	74	45	63	67	69	68	65	60	53	dB(A)
L _{WA} Surrounding	76	47	65	69	71	70	67	62	55	dB(A)

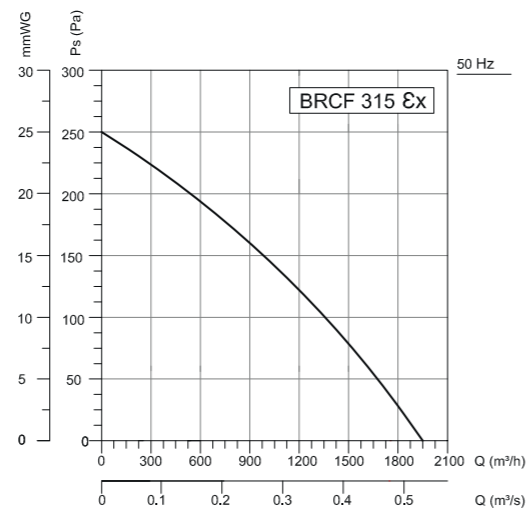

Frequency	Tot	63	125	250	500	1000	2000	4000	8000	Hz
L _{WA} Inlet	74	46	63	68	69	68	64	59	55	dB(A)
L _{WA} Surrounding	76	45	66	70	71	67	63	55	55	dB(A)

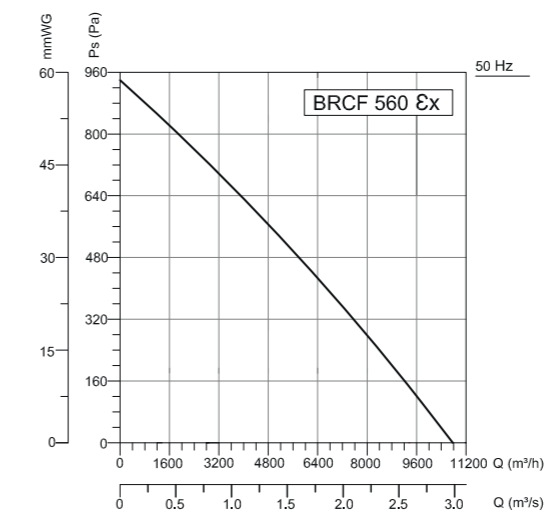

Frequency	Tot	63	125	250	500	1000	2000	4000	8000	Hz
L _{WA} Inlet	87	74	76	80	82	81	78	73	66	dB(A)
L _{WA} Surrounding	89	76	78	82	84	83	80	75	68	dB(A)

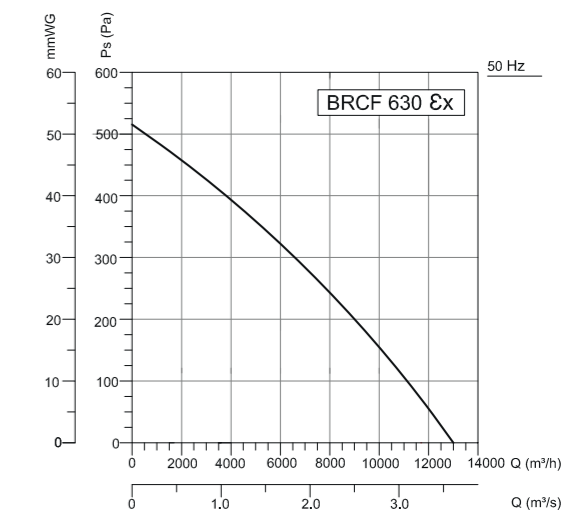

Frequency	Tot	63	125	250	500	1000	2000	4000	8000	Hz
L _{WA} Inlet	80	67	70	73	75	74	71	66	60	dB(A)
L _{WA} Surrounding	83	69	72	75	78	76	73	68	57	dB(A)

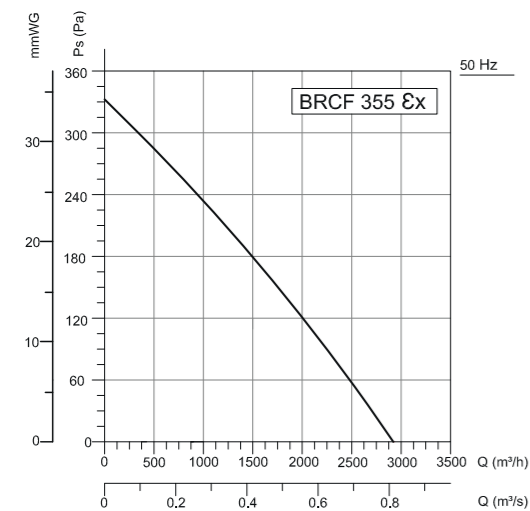

Frequency	Tot	63	125	250	500	1000	2000	4000	8000	Hz
L _{WA} Inlet	76	47	65	69	71	70	67	62	55	dB(A)
L _{WA} Surrounding	78	49	67	69	73	72	69	64	57	dB(A)

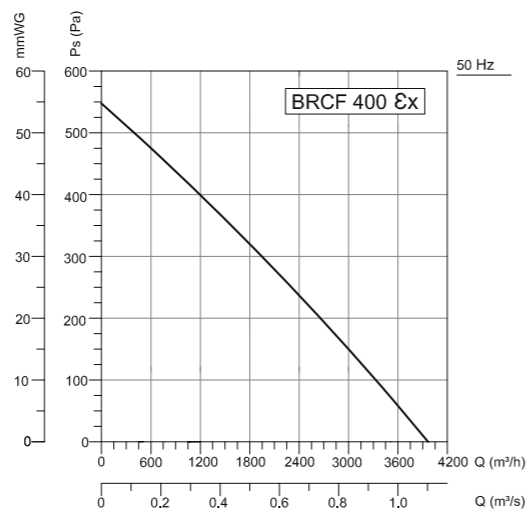

Frequency	Tot	63	125	250	500	1000	2000	4000	8000	Hz
L _{WA} Inlet	81	68	69	74	76	75	72	68	60	dB(A)
L _{WA} Surrounding	83	70	72	76	78	77	74	69	62	dB(A)

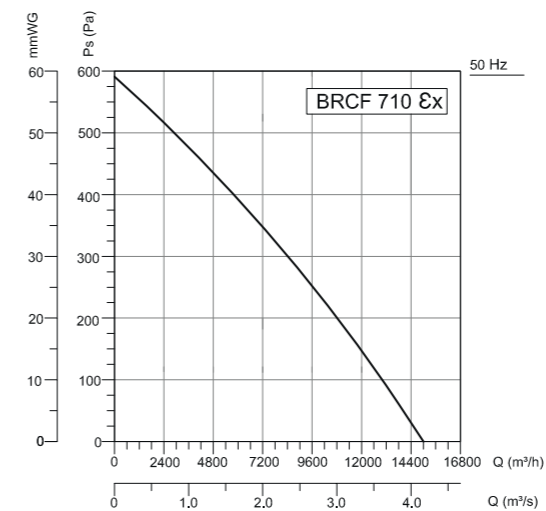

Frequency	Tot	63	125	250	500	1000	2000	4000	8000	Hz
L _{WA} Inlet	83	70	73	76	78	77	74	69	63	dB(A)
L _{WA} Surrounding	86	72	75	78	81	79	76	71	60	dB(A)

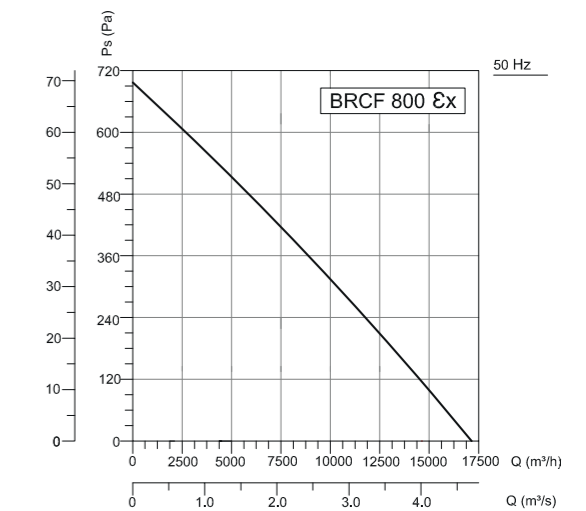

Frequency	Tot	63	125	250	500	1000	2000	4000	8000	Hz
L _{WA} Inlet	88	75	77	81	83	82	79	74	67	dB(A)
L _{WA} Surrounding	90	77	79	83	85	84	81	76	69	dB(A)



ARMO-R

HORIZONTAL OUTLET ROOF FANS / Axial

Axial roof fans are used in pressurization fan, fresh air fan and smoke exhaust fan applications. The enclosure is fire resistant and designed according to the noise standard. Smoke evacuation fans are fire resistant.

General Features

- It has EN 12101-3 and Ce certificates.
- 2 hours continuous operation at 400 C and 300 C
- There is a wide product range from 400 mm to 1250 mm.

Rotor Features

- Fire resistant aluminum alloy casting blades and fan hub.
- Has the ability to work one-way and two-way. The blades are specially designed according to each direction type.
- There is no aerodynamic loss in the case of reversible wing type operation.
- Wings are airfoil and provide high aerodynamic performance in both unidirectional and bidirectional vanes.
- Wing angles are adjustable. In this way, smoke discharge fans can be demanded at different flow rates and pressures.
- The fan part of

the fan is dynamically balanced according to ISO 1940 and there is no eccentricity during the operation of the fan.

Body Features

- Fan body is steel sheet. Body is hot dip galvanized and corrosion resistant.
- It has short type body and long type body types.

Motor Features

- Offers 2.4 and 6-pole motors
- The motors are IP 55 class and Class-H insulated.
- All electric motor models are approved for continuous operation (S1) and Emergency operation (S2).

Ease of Maintenance

A maintenance cover is provided to ensure easy maintenance.

Usage Areas

Roof type Axial fans are used in pressurization fan, fresh air fan and smoke exhaust fan applications.

Technical Drawing and Tables

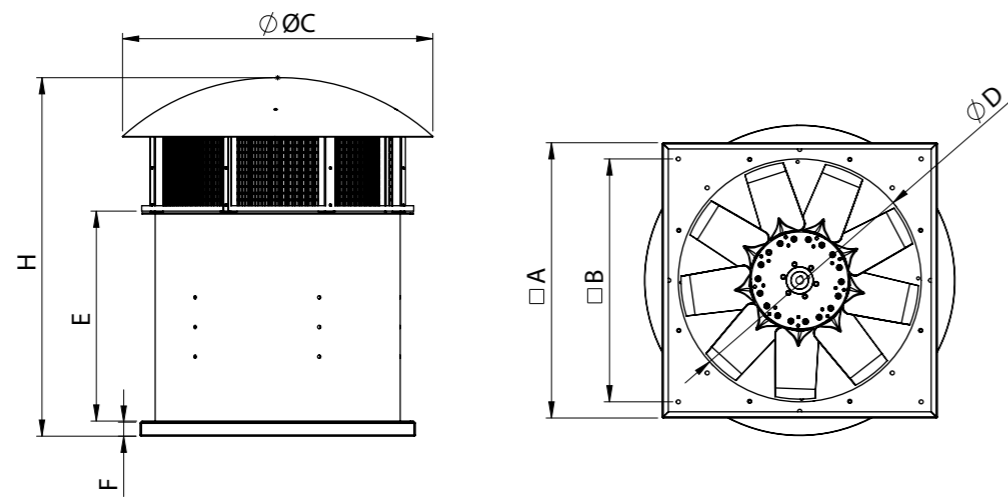

TYPE	A	B	C	D	E	H	F
ARMO-R 400	600	495	702	400	474	880	50
ARMO-R 450	650	545	702	450	474	880	50
ARMO-R 500	650	545	842	500	580	1030	50
ARMO-R 560	685	605	842	560	580	1030	50
ARMO-R 630	780	637	1130	630	600	1160	50
ARMO-R 710	830	710	1130	800	700	1300	50
ARMO-R 800	920	800	1130	800	700	1300	50
ARMO-R 900	1020	900	1130	900	775	1375	50
ARMO-R 1000	1130	1030	1430	1000	850	1450	50
ARMO-R 1250	1430	1350	1430	1250	950	1550	50

Dimensions are in (mm)



2 POLE TYPE	SPEED	DIAMETER	POWER	CURRENT	AIR FLOW	WING ANGLE
	r.p.m	mm	kW	230V - 400V	m ³ /h	
ARMO-R / 400-6 / 0,75 - 2A	2900	400	0,75	1,6	5250	16°
ARMO-R / 400-6 / 1,1 - 2A	2900	400	1,1	2,3	6904	22°
ARMO-R / 400-6 / 1,5 - 2A	2900	400	1,5	3,4	8978	30°
ARMO-R / 400-6 / 2,2 - 2A	2900	400	2,2	4,48	9975	34°
ARMO-R / 450-6 / 1,1 - 2A	2900	450	1,1	2,3	6248	10°
ARMO-R / 450-6 / 1,5 - 2A	2900	450	1,5	3,4	8610	16°
ARMO-R / 450-6 / 2,2 - 2A	2900	450	2,2	4,48	11970	24°
ARMO-R / 450-6 / 3 - 2A	2900	450	3	6	13545	28°
ARMO-R / 500-6 / 2,2 - 2A	2900	500	2,2	4,48	11000	14°
ARMO-R / 500-6 / 3 - 2A	2900	500	3	6	14595	20°
ARMO-R / 500-6 / 4 - 2A	2900	500	4	7,4	17325	26°
ARMO-R / 500-6 / 5,5 - 2A	2900	500	5,5	11	18375	28°
ARMO-R / 560-6 / 4 - 2A	2900	560	4	7,4	17850	14°
ARMO-R / 560-6 / 5,5 - 2A	2900	560	5,5	11	22313	20°
ARMO-R / 560-6 / 7,5 - 2A	2800	560	7,5	13,6	25725	24°
ARMO-R / 630-6 / 5,5 - 2A	2900	630	5,5	11	20475	10°
ARMO-R / 630-6 / 7,5 - 2A	2800	630	7,5	13,6	27300	16°

4 POLE TYPE	SPEED	DIAMETER	POWER	CURRENT	AIR FLOW	WING ANGLE
	r.p.m	mm	kW	230V - 400V	m ³ /h	
ARMO-R / 500-6 / 0,55- 4A	1415	500	0,55	1,6	8715	26
ARMO-R / 500-6 / 0,75- 4A	1350	500	0,75	2,1	10290	32
ARMO-R / 500-6 / 1,1- 4A	1400	500	1,1	2,6	12600	38
ARMO-R / 560-6 / 0,55- 4A	1415	560	0,55	1,6	9870	16
ARMO-R / 560-6 / 0,75- 4A	1350	560	0,75	2,1	12075	22
ARMO-R / 560-6 / 1,1- 4A	1400	560	1,1	2,6	13860	26
ARMO-R / 560-6 / 1,5- 4A	1405	560	1,5	3,5	15750	32
ARMO-R / 560-6 / 2,2- 4A	1410	560	2,2	5	17850	38
ARMO-R / 630-6 / 0,75- 4A	1350	630	0,75	2,1	10605	10
ARMO-R / 630-6 / 1,1- 4A	1400	630	1,1	2,6	16275	20
ARMO-R / 630-6 / 1,5- 4A	1405	630	1,5	3,5	18375	24
ARMO-R / 630-6 / 2,2- 4A	1410	630	2,2	5	21525	30
ARMO-R / 630-6 / 3- 4A	1410	630	3	6,6	24150	36
ARMO-R / 630-6 / 4- 4A	1500	630	4	8,2	25200	38
ARMO-R / 710-3 / 0,75- 4A	1350	710	0,75	2,1	14175	10
ARMO-R / 710-3 / 1,1- 4A	1400	710	1,1	2,6	18375	16
ARMO-R / 710-3 / 1,5- 4A	1405	710	1,5	3,5	21000	20
ARMO-R / 710-3 / 2,2- 4A	1410	710	2,2	5	24413	26
ARMO-R / 710-3 / 3- 4A	1410	710	3	6,6	27825	32
ARMO-R / 710-6 / 1,1- 4A	1400	710	1,1	2,6	16275	12
ARMO-R / 710-6 / 1,5- 4A	1405	710	1,5	3,5	20475	18
ARMO-R / 710-6 / 2,2- 4A	1410	710	2,2	5	23625	22
ARMO-R / 710-6 / 3- 4A	1410	710	3	6,6	28350	28
ARMO-R / 710-6 / 4- 4A	1415	710	4	8,2	31500	32
ARMO-R / 800-6 / 2,2- 4A	1410	800	2,2	5	24150	14
ARMO-R / 800-6 / 3- 4A	1410	800	3	6,6	30450	20
ARMO-R / 800-6 / 4- 4A	1415	800	4	8,2	32550	22
ARMO-R / 800-6 / 5,5- 4A	1430	800	5,5	11,2	38850	28
ARMO-R / 800-6 / 7,5- 4A	1440	800	7,5	15,4	42525	32
ARMO-R / 800-9 / 2,2- 4A	1410	800	2,2	5	16275	10
ARMO-R / 800-9 / 3- 4A	1410	800	3	6,6	21525	14
ARMO-R / 800-9 / 4- 4A	1415	800	4	8,2	29400	20
ARMO-R / 800-9 / 5,5- 4A	1430	800	5,5	11,2	36488	26
ARMO-R / 800-9 / 7,5- 4A	1440	800	7,5	15,4	40950	30
ARMO-R / 800-9 / 11- 4A	1450	800	11	21	43050	32
ARMO-R / 900-6 / 4- 4A	1415	900	4	8,2	31500	12
ARMO-R / 900-6 / 5,5- 4A	1430	900	5,5	11,2	38850	16
ARMO-R / 900-6 / 7,5- 4A	1440	900	7,5	15,4	47775	22
ARMO-R / 900-6 / 11- 4A	1450	900	11	21	56700	28
ARMO-R / 900-6 / 15- 4A	1450	900	15	29,3	60900	32
ARMO-R / 900-9 / 4- 4A	1415	900	4	8,2	26775	10
ARMO-R / 900-9 / 5,5- 4A	1430	900	5,5	11,2	34125	14
ARMO-R / 900-9 / 7,5- 4A	1440	900	7,5	15,4	41213	18
ARMO-R / 900-9 / 11- 4A	1450	900	11	21	54600	26
ARMO-R / 900-9 / 15- 4A	1450	900	15	29,3	63525	32
ARMO-R / 1000-6 / 5,5- 4A	1430	1000	5,5	11,2	38850	12
ARMO-R / 1000-6 / 7,5- 4A	1440	1000	7,5	15,4	47775	18
ARMO-R / 1000-6 / 11- 4A	1450	1000	11	21	56700	22
ARMO-R / 1000-6 / 15- 4A	1450	1000	15	29,3	60900	28
ARMO-R / 1000-6 / 18,5- 4A	1455	1000	18,5	34,5	56700	32
ARMO-R / 1000-9 / 7,5- 4A	1440	1000	7,5	15,4	43050	12
ARMO-R / 1000-9 / 11- 4A	1450	1000	11	21	55650	18
ARMO-R / 1000-9 / 15- 4A	1450	1000	15	29,3	69300	24
ARMO-R / 1000-9 / 18,5- 4A	1455	1000	18,5	34,5	77700	28
ARMO-R / 1000-9 / 22- 4A	1460	1000	22	42,5	81900	30
ARMO-R / 1000-9 / 30- 4A	1460	1000	30	55	86100	32
ARMO-R / 1250-6 / 15- 4A	1450	1250	15	29,3	90300	12
ARMO-R / 1250-6 / 18,5- 4A	1455	1250	18,5	34,5	103950	16
ARMO-R / 1250-6 / 22- 4A	1460	1250	22	42,5	109725	18
ARMO-R / 1250-6 / 30- 4A	1460	1250	30	55	122850	22
ARMO-R / 1250-6 / 37- 4A	1470	1250	37	67	136500	26
ARMO-R / 1250-6 / 45- 4A	1475	1250	45	80	155400	32
ARMO-R / 1250-9 / 18,5- 4A	1455	1250	18,5	34,5	89250	12
ARMO-R / 1250-9 / 22- 4A	1460	1250	22	42,5	97650	14
ARMO-R / 1250-9 / 30- 4A	1460	1250	30	55	114975	18
ARMO-R / 1250-9 / 37- 4A	1470	1250	37	67	131250	22
ARMO-R / 1250-9 / 45- 4A	1475	1250	45	80	138600	24

6 POLE TYPE	SPEED	DIAMETER	POWER	CURRENT	AIR FLOW	WING ANGLE
	r.p.m	mm	kW	230V - 400V	m ³ /h	
ARMO-R / 500-6 / 0,37- 6A	900	500	0,37	1,1	8400	38
ARMO-R / 560-6 / 0,37- 6A	900	560	0,37	1,1	10500	32
ARMO-R / 560-6 / 0,55- 6A	930	560	0,55	1,5	11760	38
ARMO-R / 630-6 / 0,37- 6A	900	630	0,37	1,1	11576	22
ARMO-R / 630-6 / 0,55- 6A	930	630	0,55	1,5	13650	28
ARMO-R / 630-6 / 0,75- 6A	945	630	0,75	2	14963	32
ARMO-R / 630-6 / 1,1- 6A	945	630	1,1	2,9	16800	38
ARMO-R / 710-3 / 0,37- 6A	900	710	0,37	1,1	13125	18
ARMO-R / 710-3 / 0,55- 6A	930	710	0,55	1,5	16538	26
ARMO-R / 710-3 / 0,75- 6A	945	710	0,75	2	18900	32
ARMO-R / 710-6 / 1,1- 6A	945	710	1,1	2,9	11025	12
ARMO-R / 710-6 / 1,5- 6A	945	710	1,5	3,6	13000	16
ARMO-R / 710-6 / 2,2- 6A	950	710	2,2	5,4	13750	22
ARMO-R / 710-6 / 3- 6A	950	710	3	6,9	18900	28
ARMO-R / 710-6 / 4- 6A	955	710	4	9	21000	32
ARMO-R / 800-6 / 0,55- 6A	930	800	0,55		13125	10
ARMO-R / 800-6 / 1,1- 6A	945	800	1,1	2,9	22050	22
ARMO-R / 800-6 / 1,5- 6A	945	800	1,5	3,6	25200	26
ARMO-R / 800-6 / 2,2- 6A	950	800	2,2	5,4	28350	32
ARMO-R / 800-9 / 0,75- 6A	945	800	0,75	2	14700	14
ARMO-R / 800-9 / 1,1- 6A	945	800	1,1	2,9	19950	20
ARMO-R / 800-9 / 1,5- 6A	945	800	1,5	3,6	23100	24
ARMO-R / 800-9 / 2,2- 6A	950	800	2,2	5,4	27300	30
ARMO-R / 800-9 / 3- 6A	950	800	3	6,9	28350	32
ARMO-R / 900-6 / 1,1- 6A	945	900	1,1	2,9	23100	14
ARMO-R / 900-6 / 1,5- 6A	945	900	1,5	3,6	25200	16
ARMO-R / 900-6 / 2,2- 6A	950	900	2,2	5,4	31500	22
ARMO-R / 900-6 / 3- 6A	950	900	3	6,9	36750	28
ARMO-R / 900-6 / 4- 6A	955	900	4	9	40950	32
ARMO-R / 900-9 / 1,5- 6A	945	900	1,5	3,6	23100	14
ARMO-R / 900-9 / 2,2- 6A	950	900	2,2	5,4	27300	20
ARMO-R / 900-9 / 3- 6A	950	900	3	6,9	35700	24
ARMO-R / 900-9 / 4- 6A	955	900	4	9	39900	30
ARMO-R / 900-9 / 5,5- 6A	985	900	5,5	12,3	43050	32
ARMO-R / 1000-6 / 1,5- 6A	945	1000	1,5	3,6	26250	10
ARMO-R / 1000-6 / 2,2- 6A	950	1000	2,2	5,4	34650	16
ARMO-R / 1000-6 / 3- 6A	950	1000	3	6,9	44100	22
ARMO-R / 1000-6 / 4- 6A	955	1000	4	9	49350	26
ARMO-R / 1000-6 / 5,5- 6A	985	1000	5,5	12,3	55650	32
ARMO-R / 1000-9 / 2,2- 6A	950	1000	2,2	5,4	32550	14
ARMO-R / 1000-9 / 3- 6A	950	1000	3	6,9	39900	20
ARMO-R / 1000-9 / 4- 6A	955	1000	4	9	43050	22
ARMO-R / 1000-9 / 5,5- 6A	985	1000	5,5	12,3	52500	28
ARMO-R / 1000-9 / 7,5- 6A	960	1000	7,5	15	57750	32
ARMO-R / 1250-6 / 4- 6A	955	1250	4	9	60900	12
ARMO-R / 1250-6 / 5,5- 6A	985	1250	5,5	12,3	63300	16
ARMO-R / 1250-6 / 7,5- 6A	960	1250	7,5	15	76650	20
ARMO-R / 1250-6 / 11- 6A	960	1250	11	22	92400	26
ARMO-R / 1250-6 / 15- 6A	965	1250	15	29	105000	32
ARMO-R / 1250-9 / 7,5- 6A	960	1250	7,5	15	73500	16
ARMO-R / 1250-9 / 11- 6A	960	1250	11	22	88200	22
ARMO-R / 1250-9 / 15- 6A	965	1250	15	29	105000	28
ARMO-R / 1250-9 / 18,5- 6A	970	1250	18,5	36,5	115500	32

Accessories



BSC-F

BSST

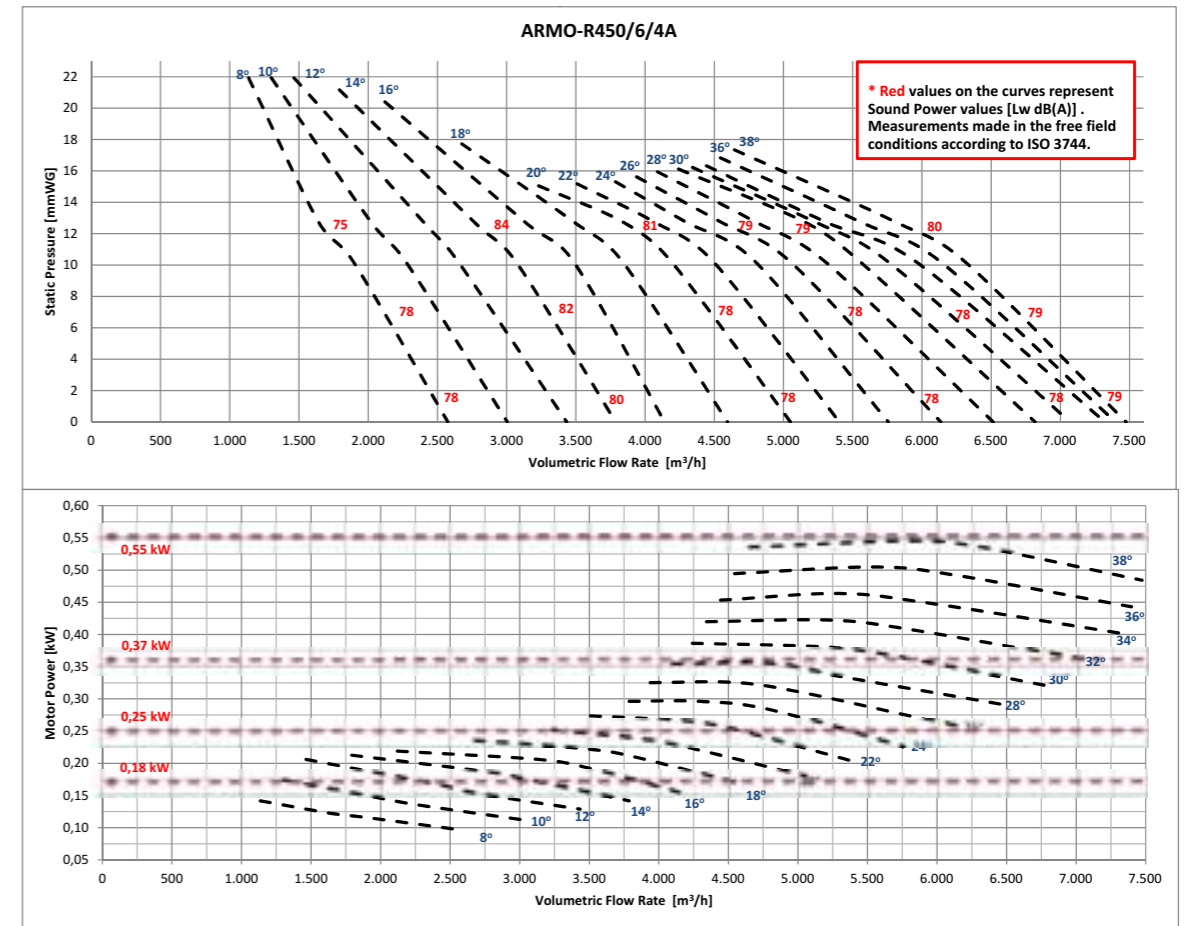
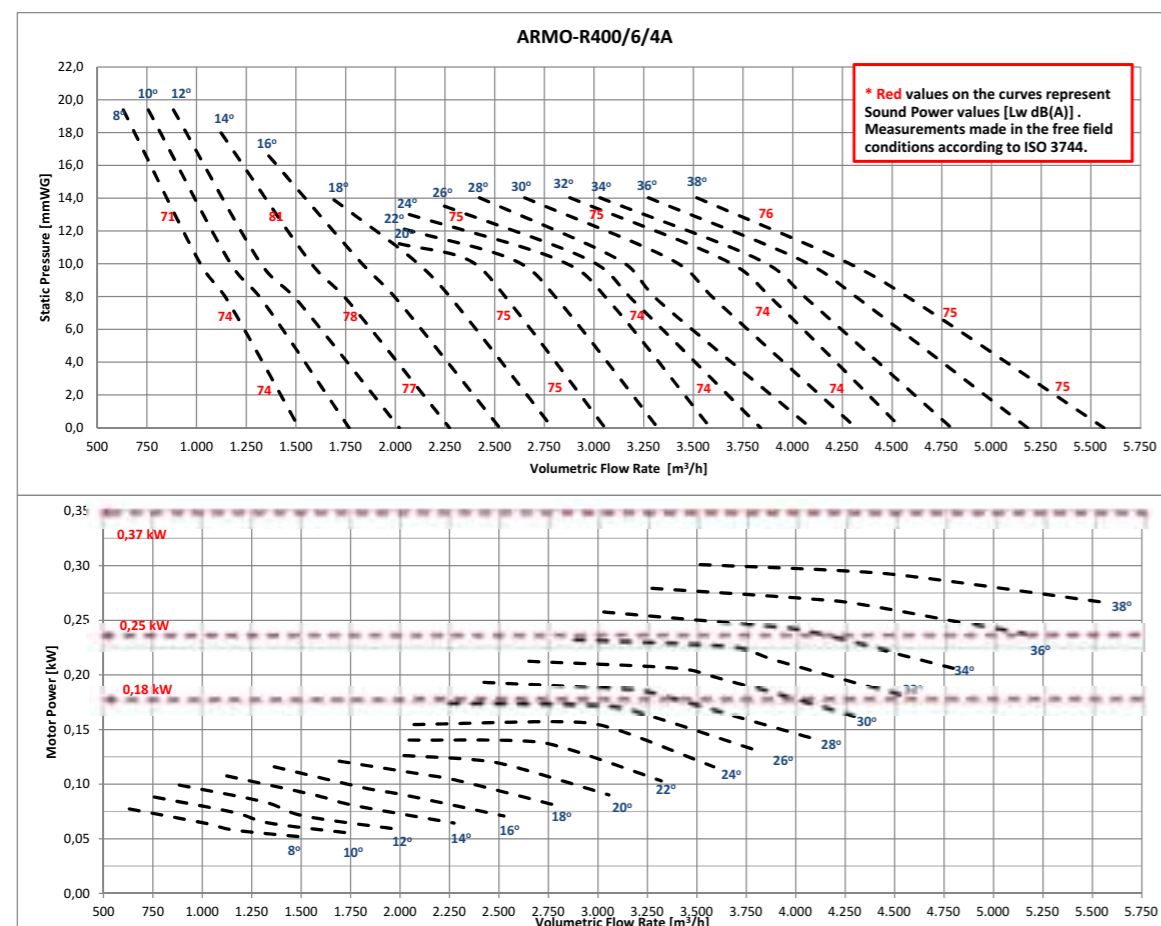
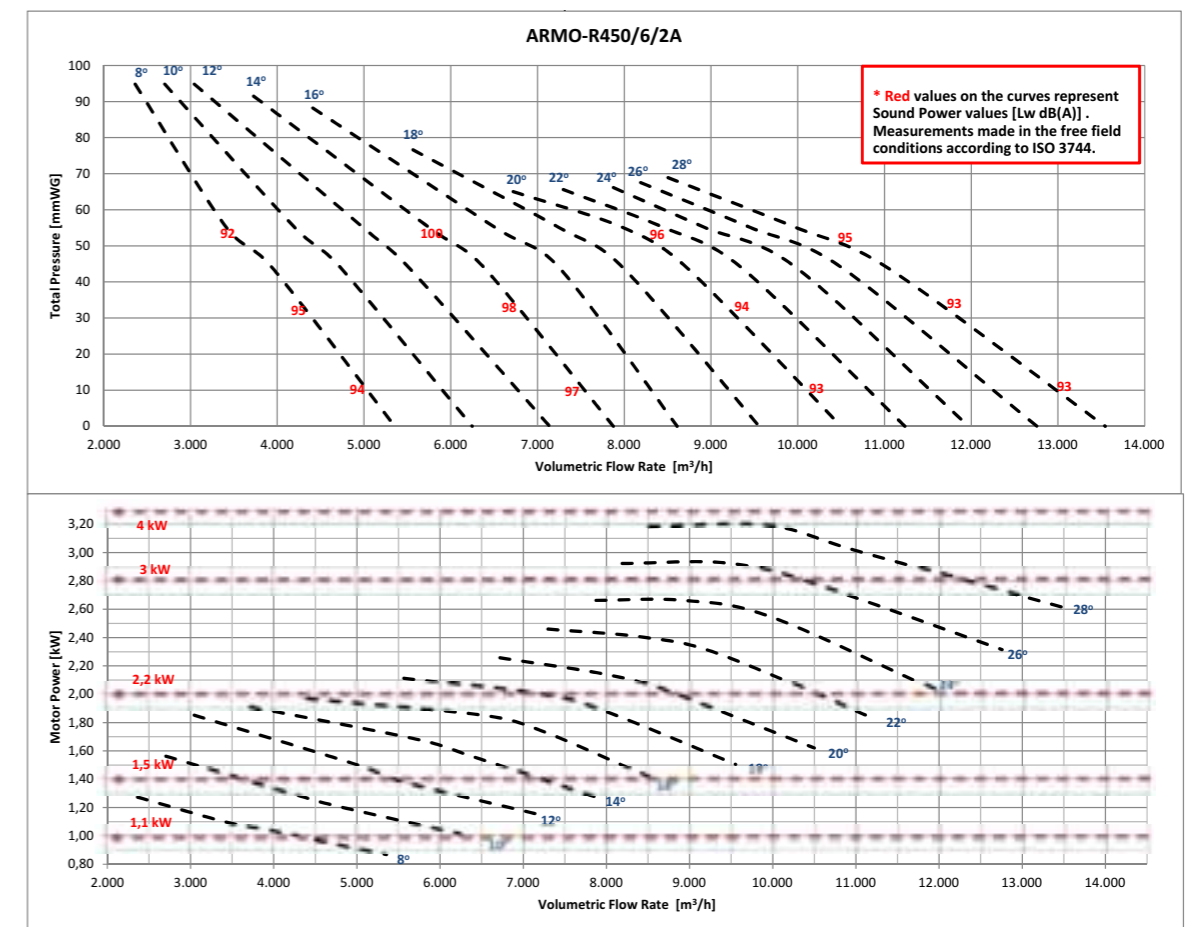
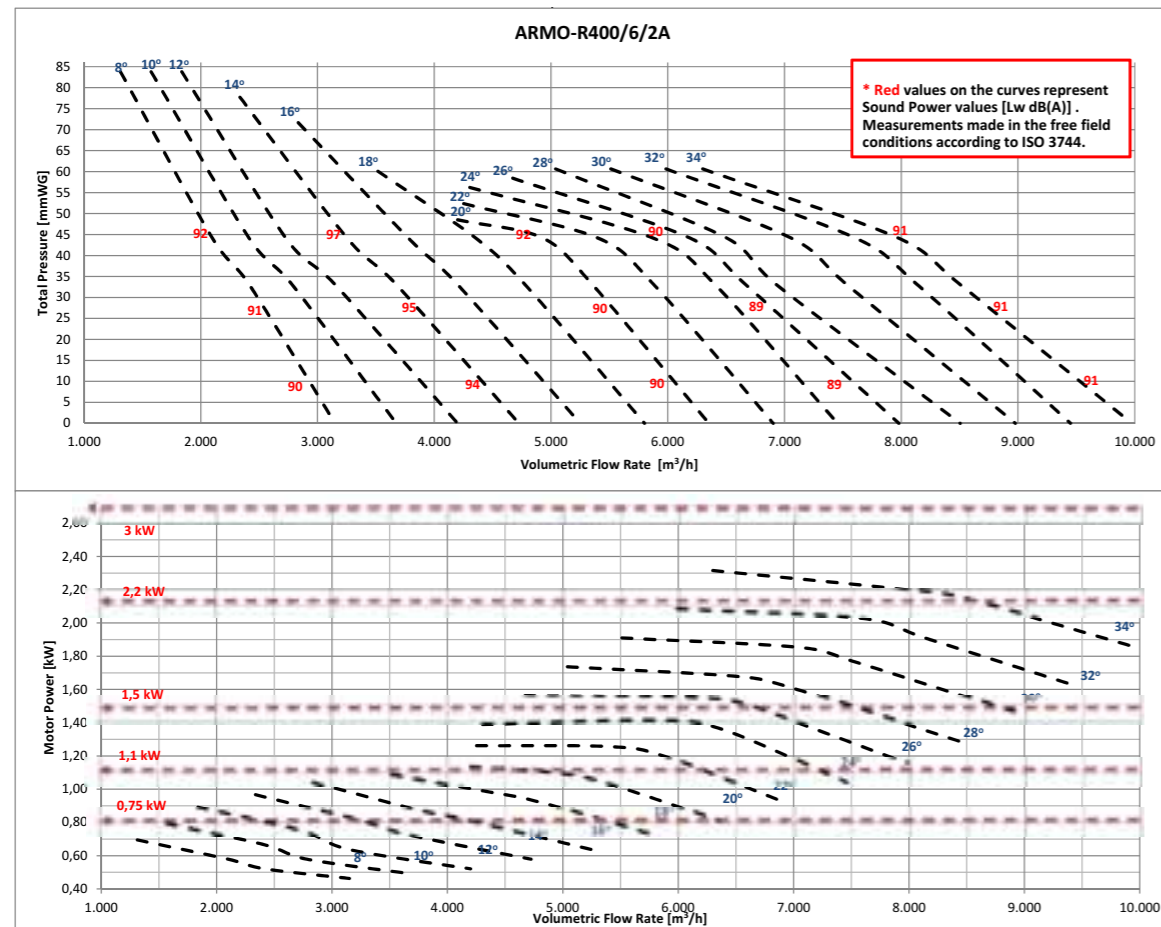

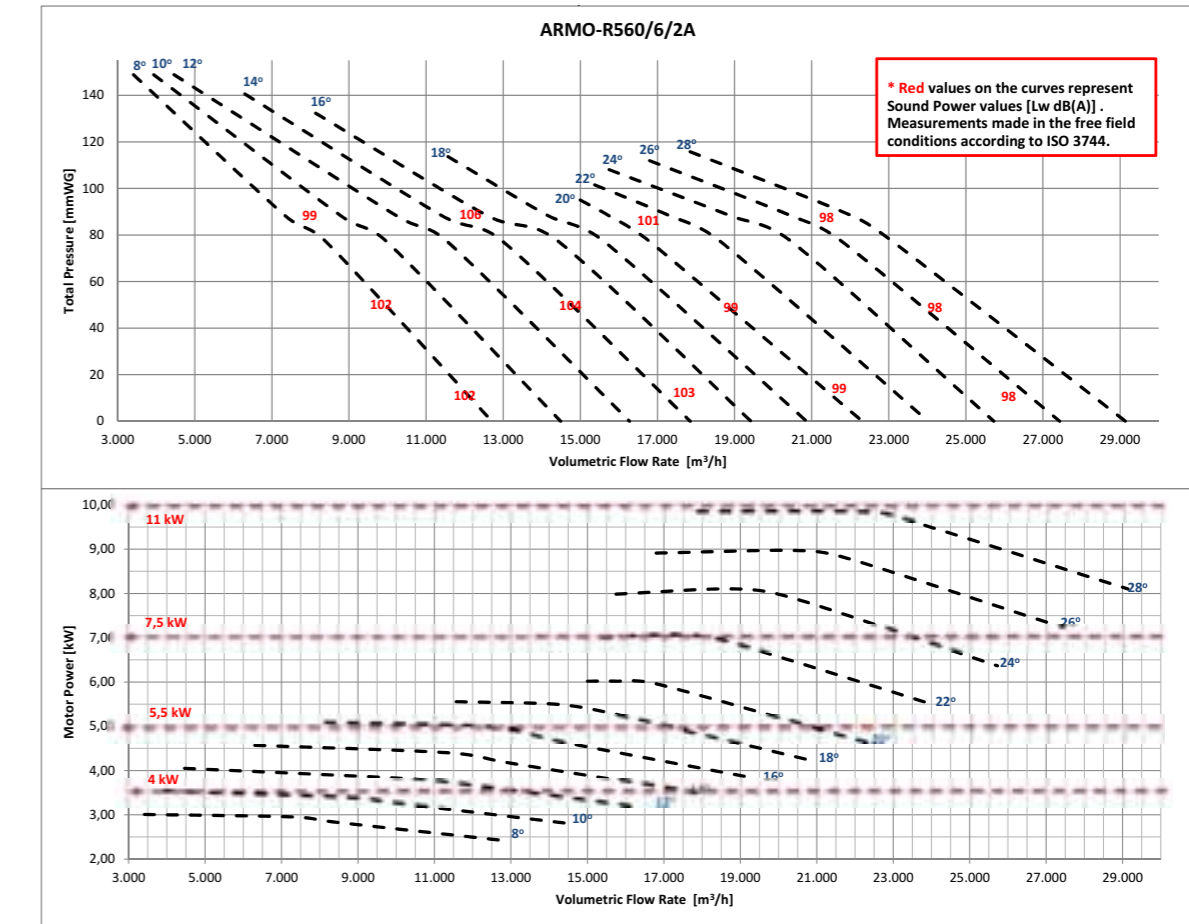
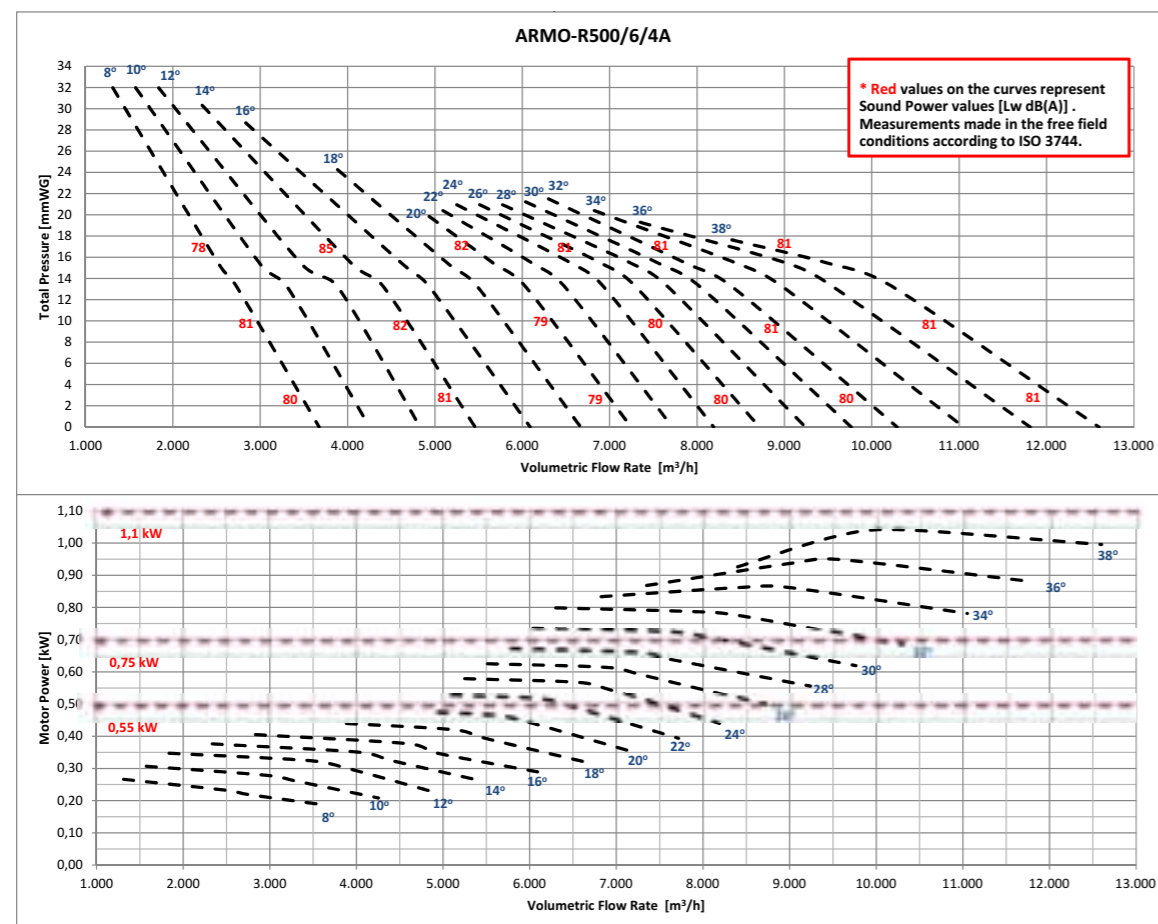
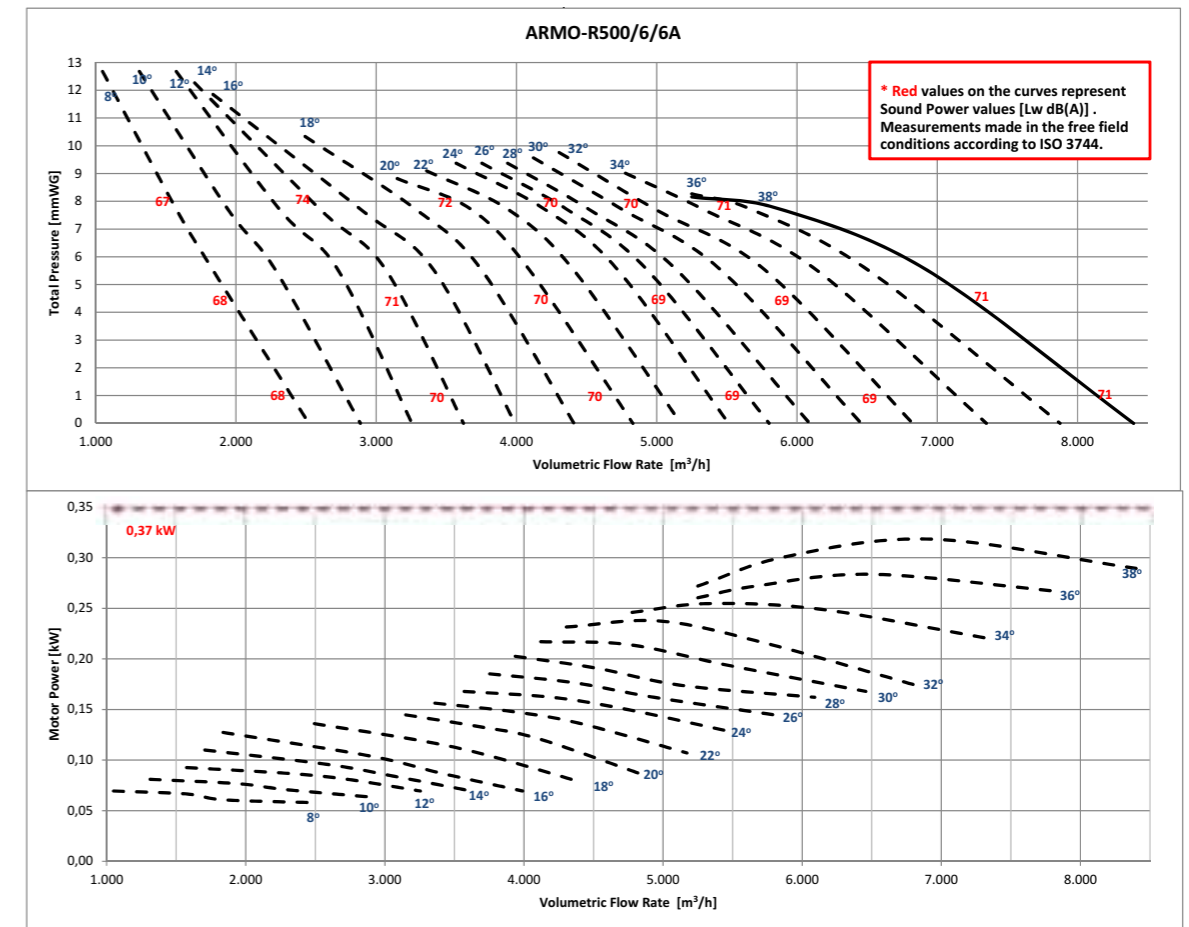
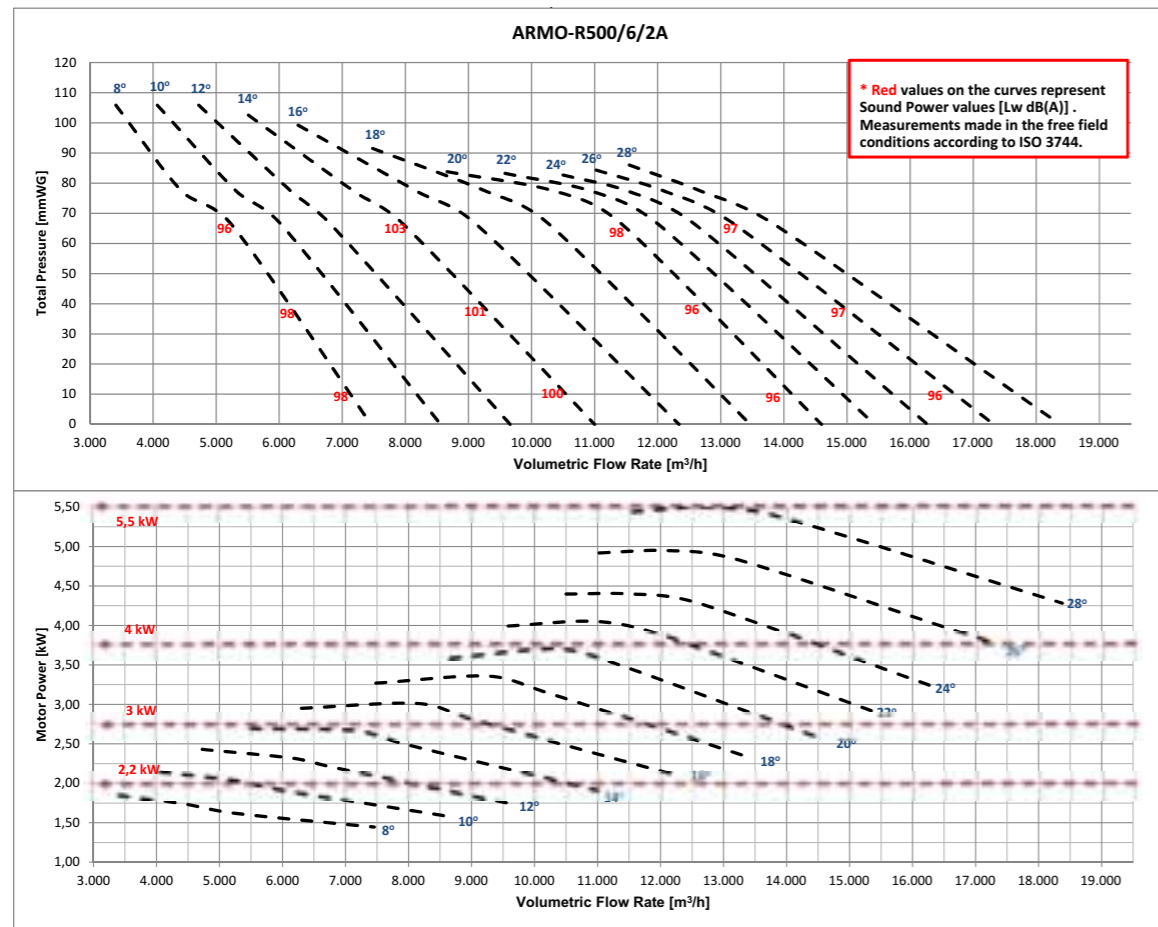

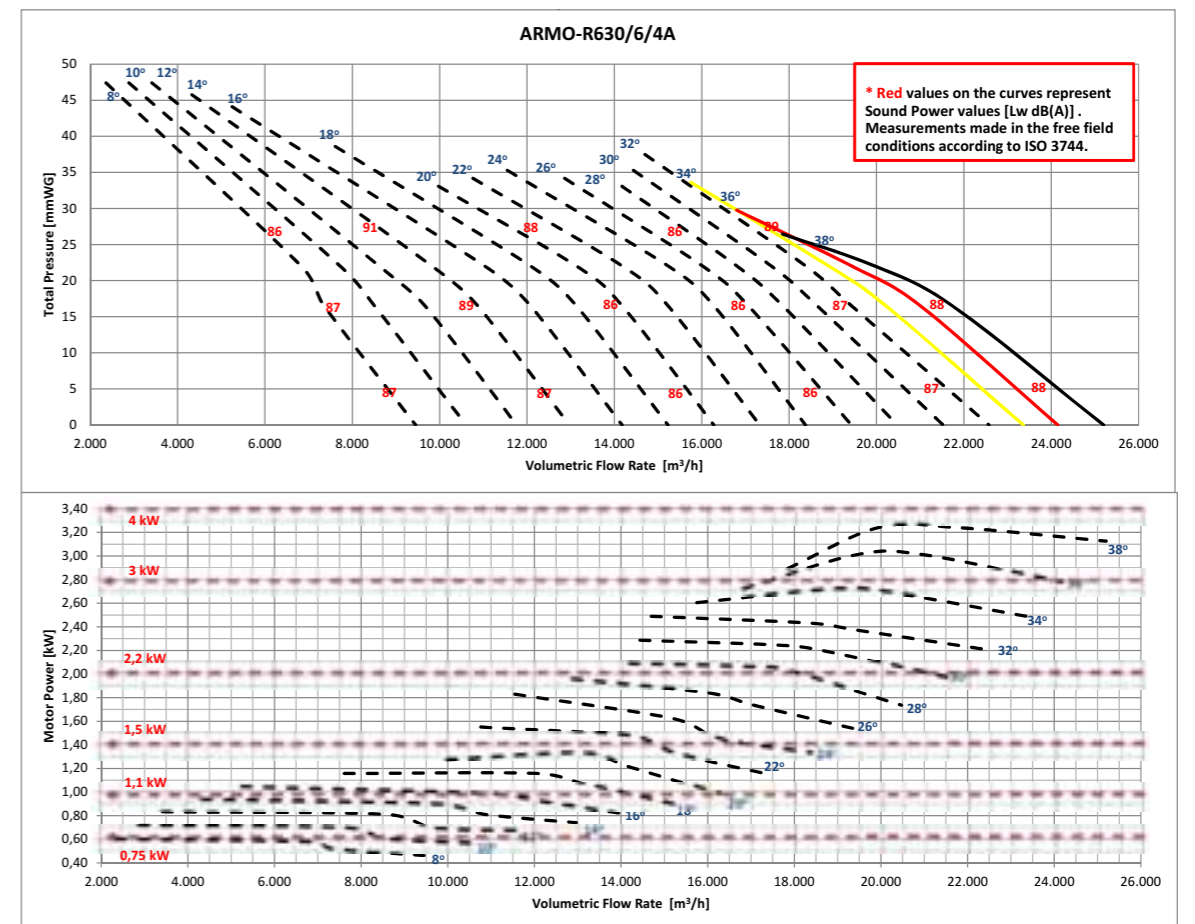
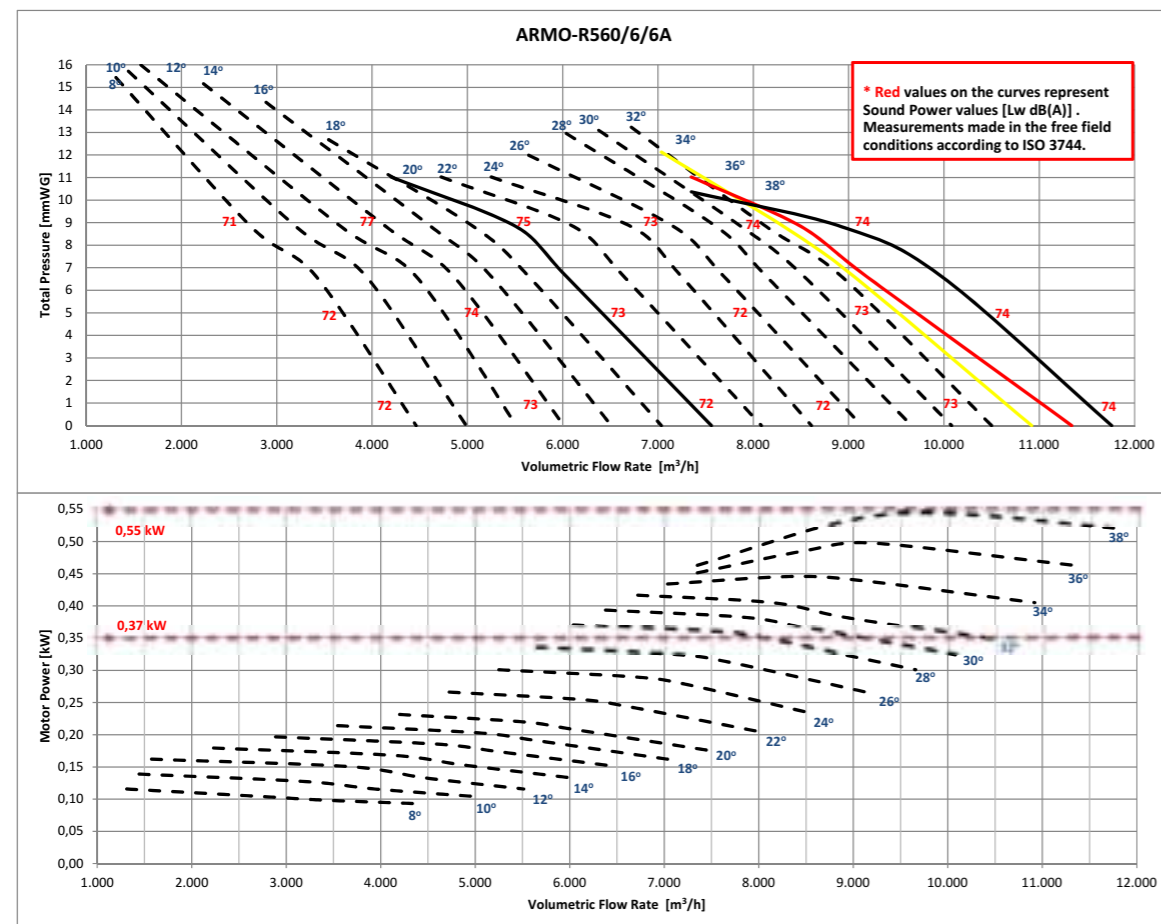
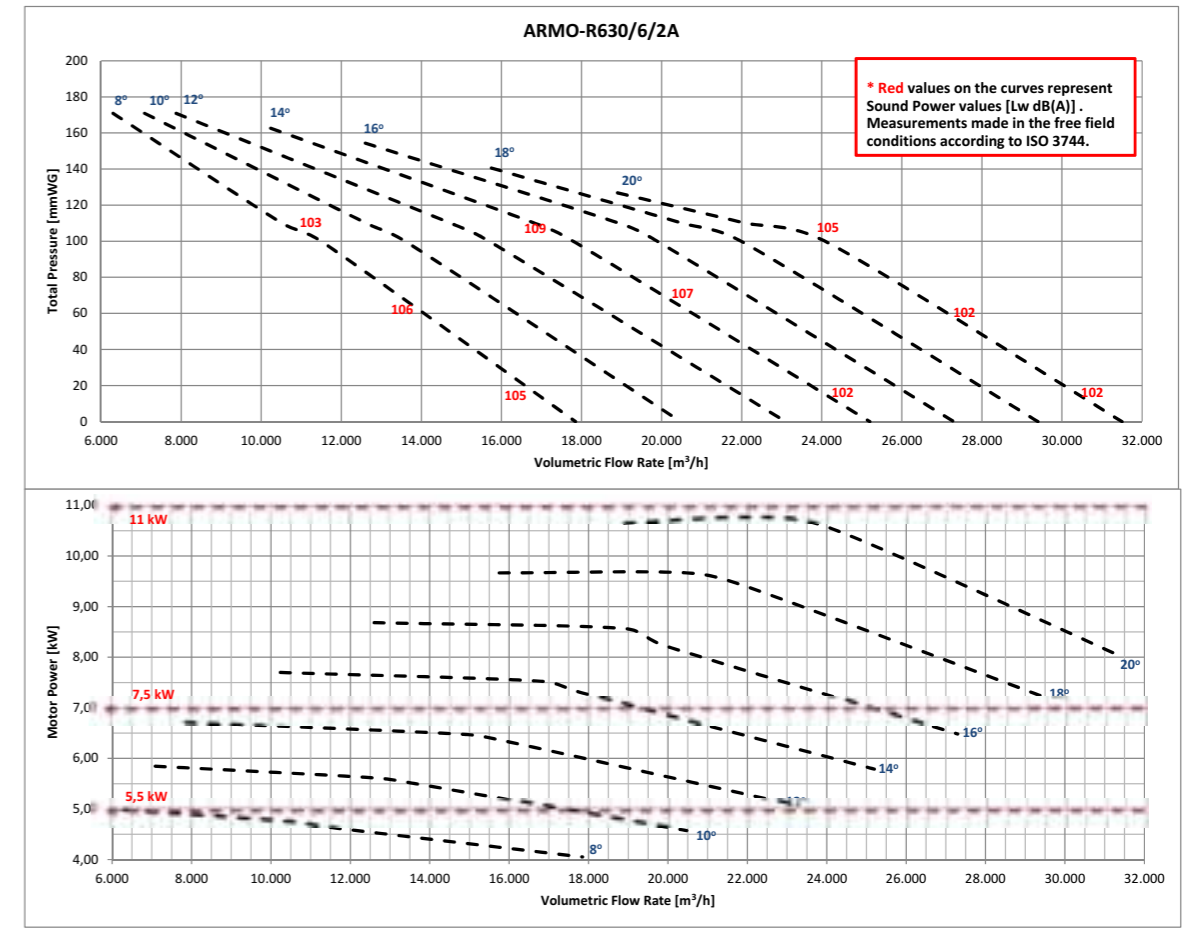
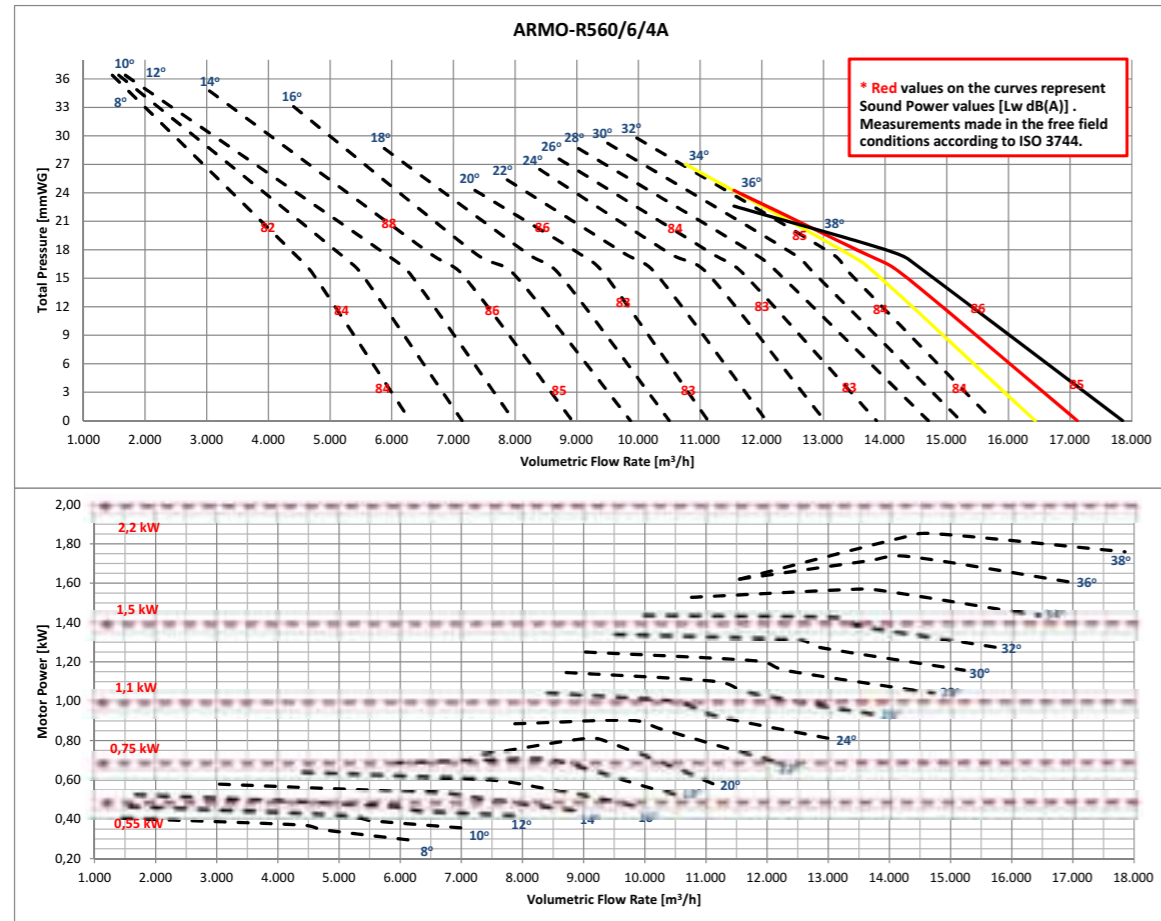

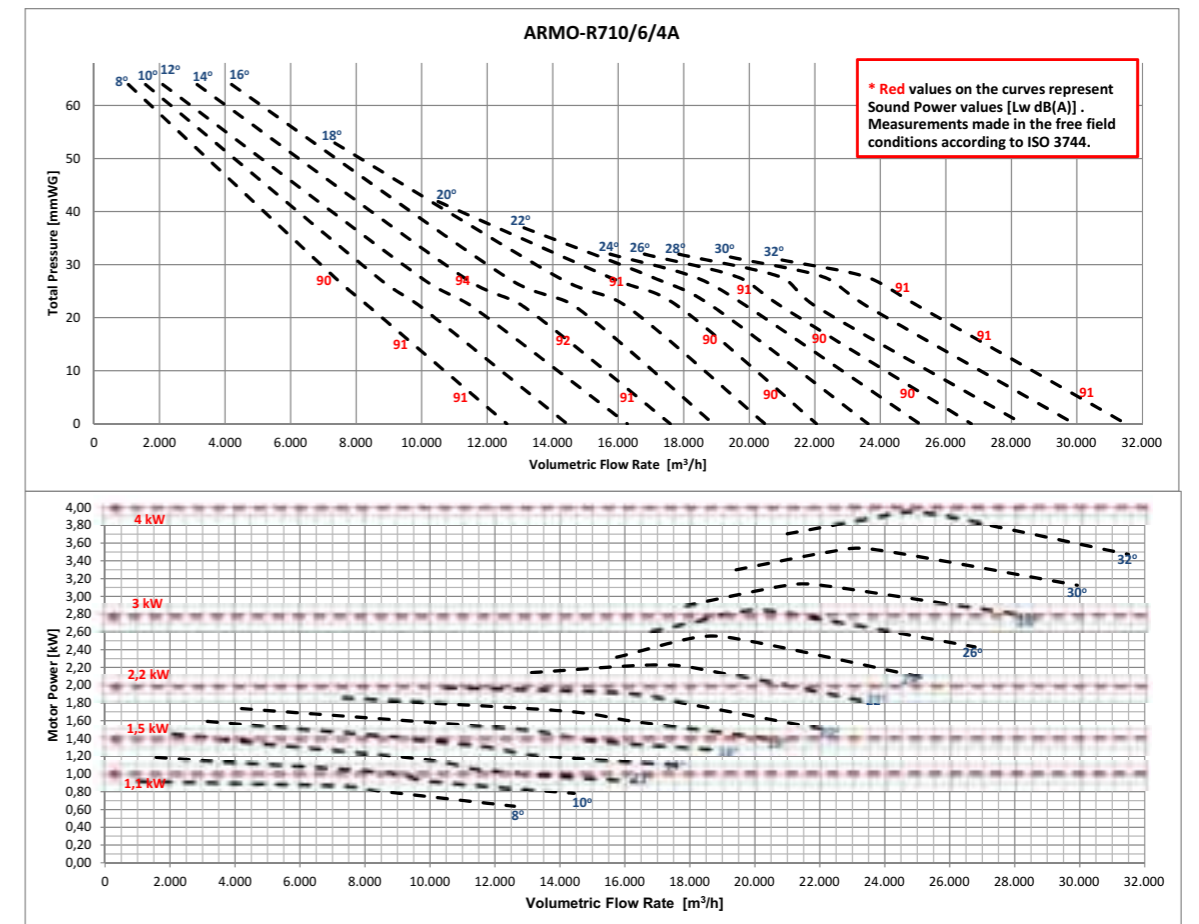
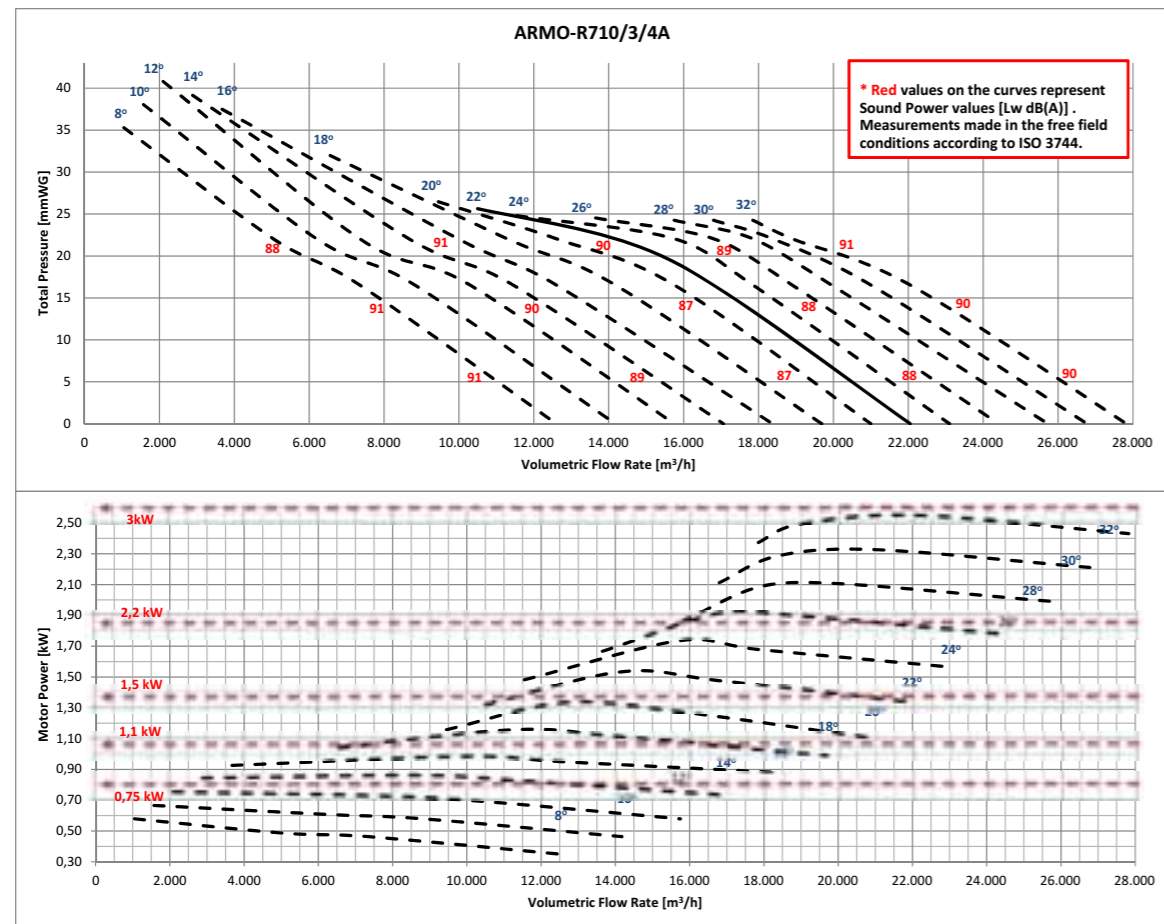
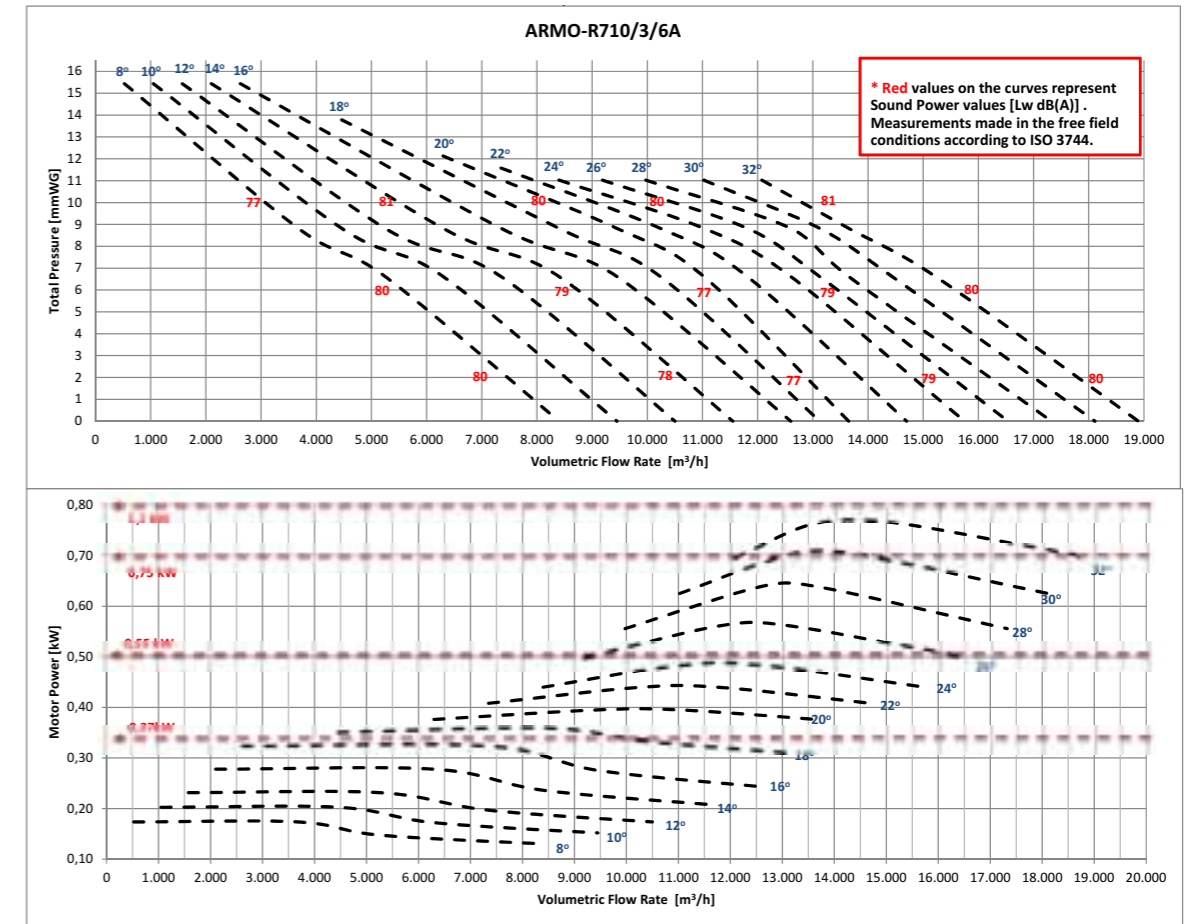
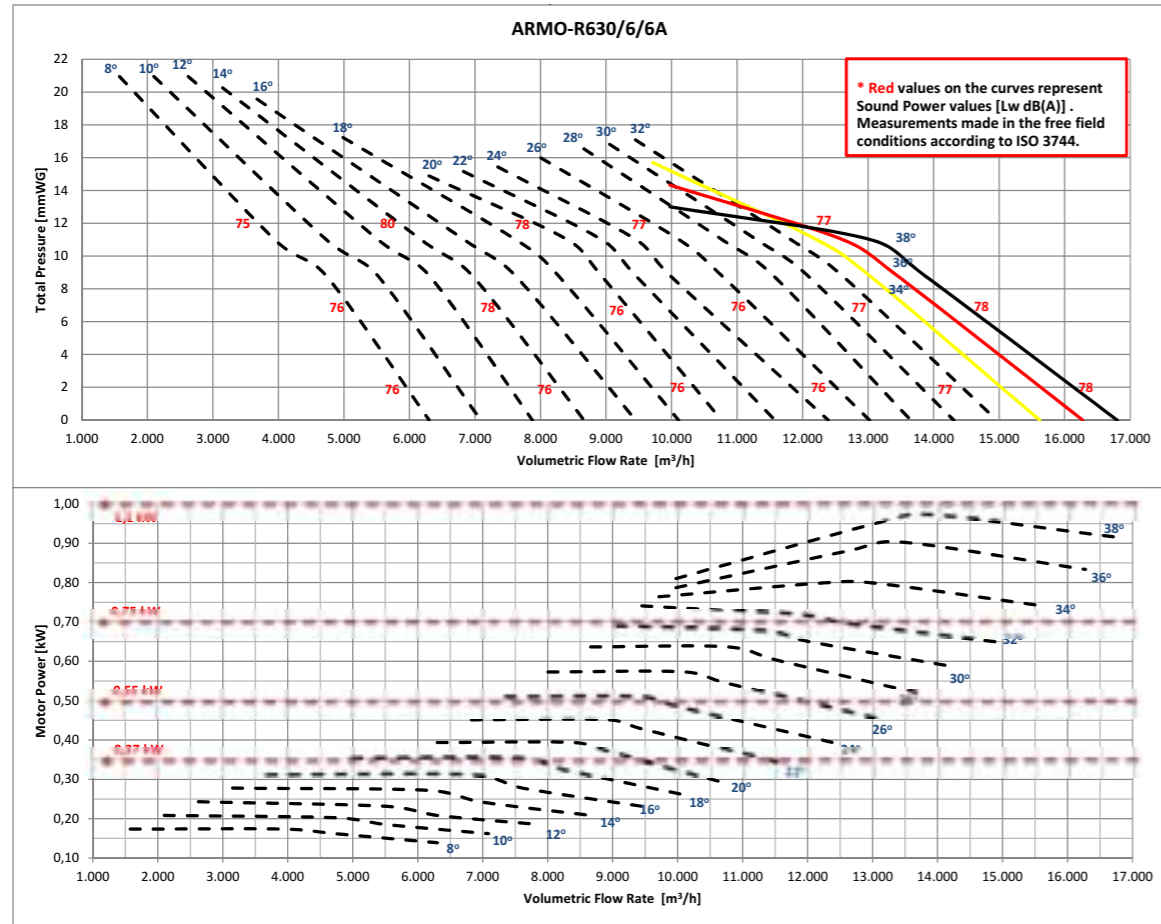

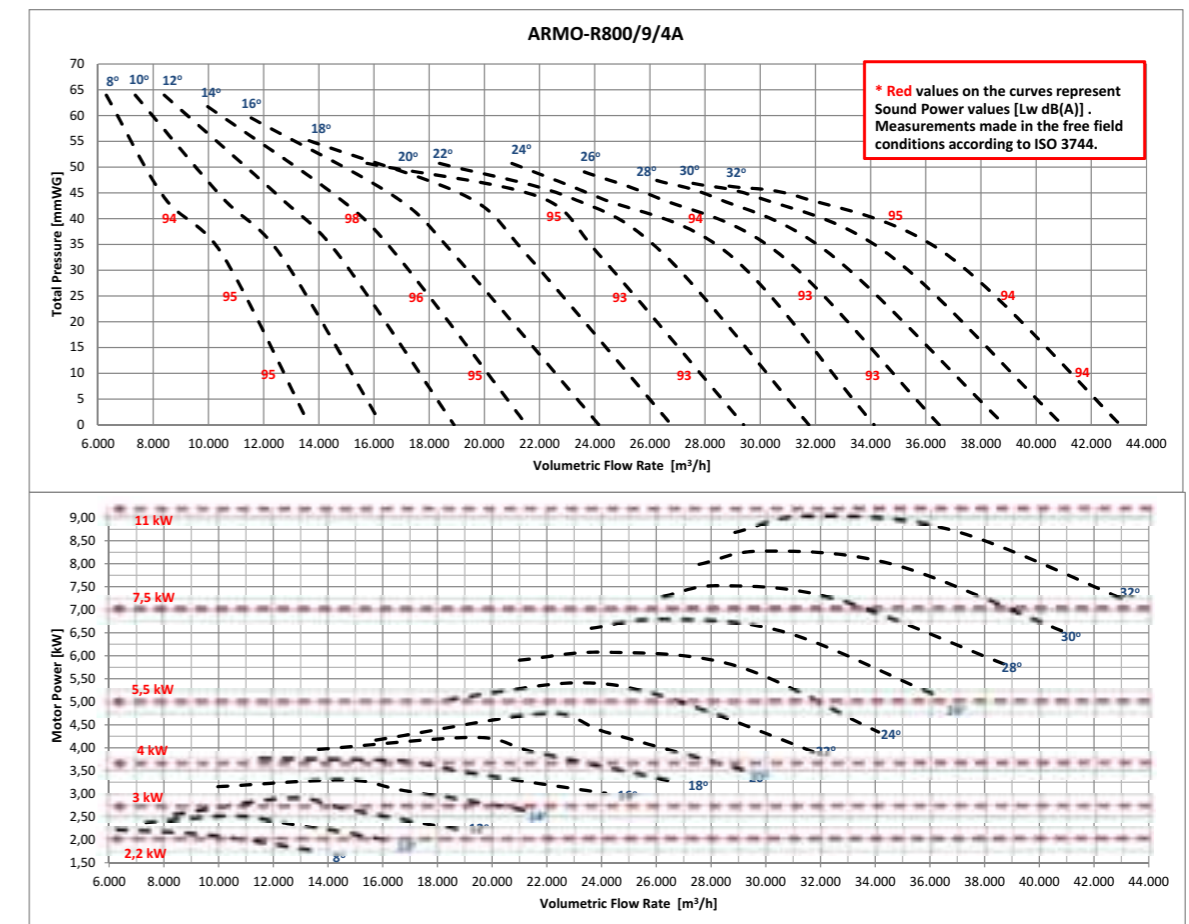
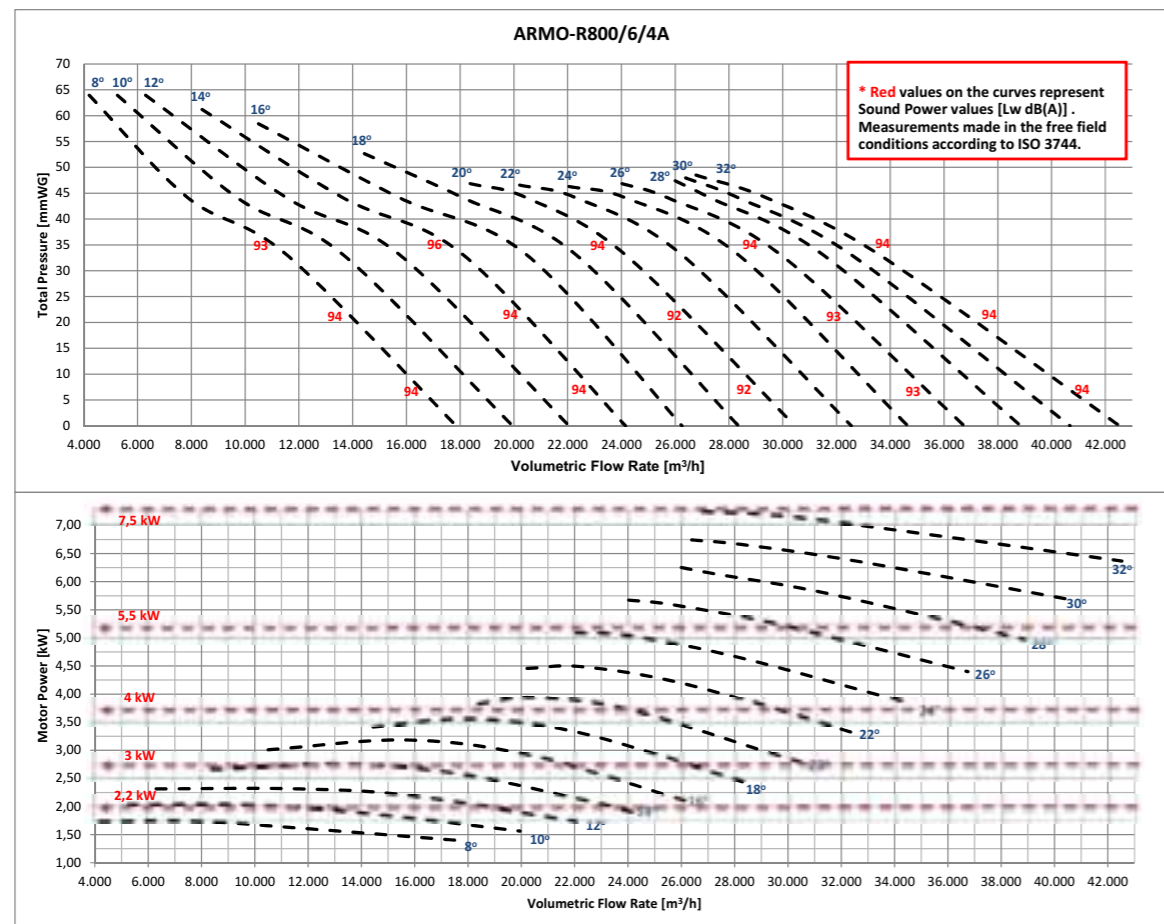
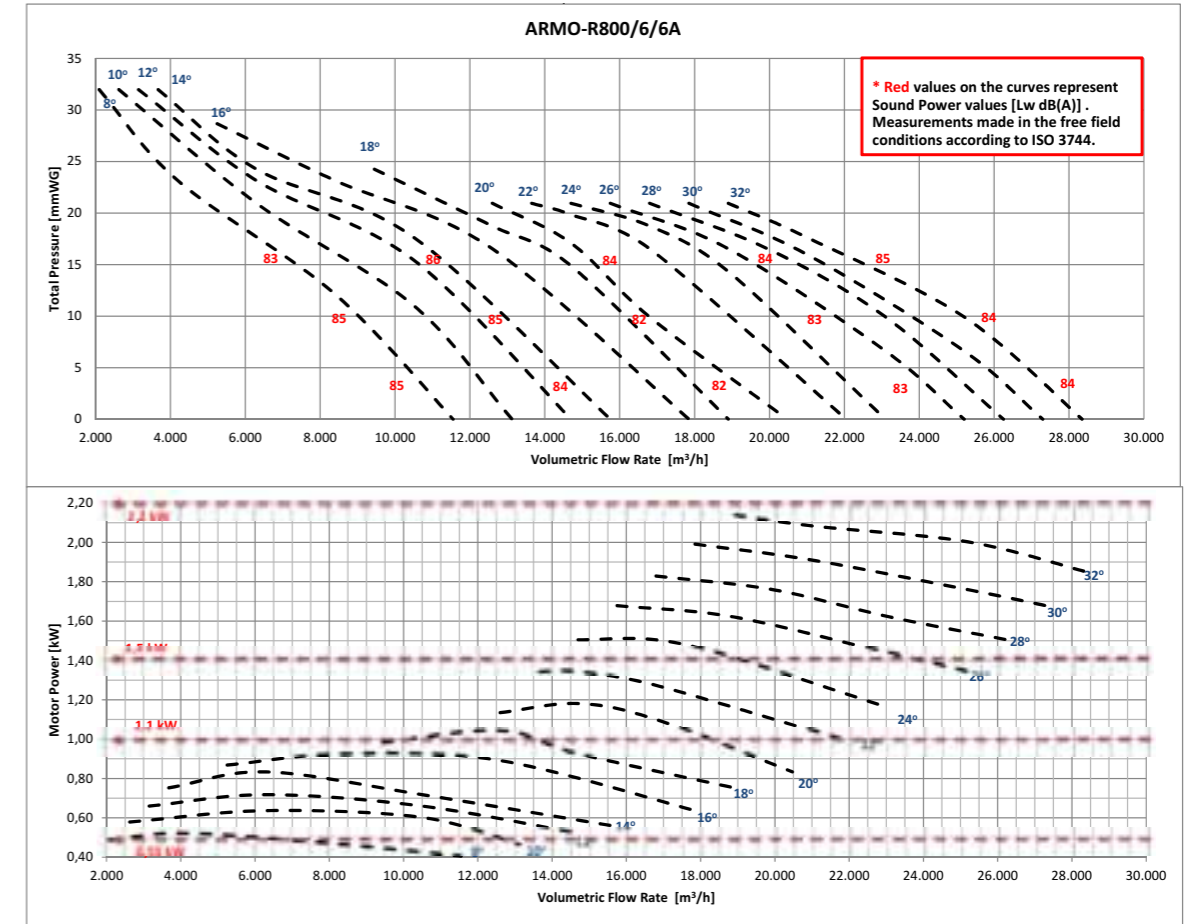
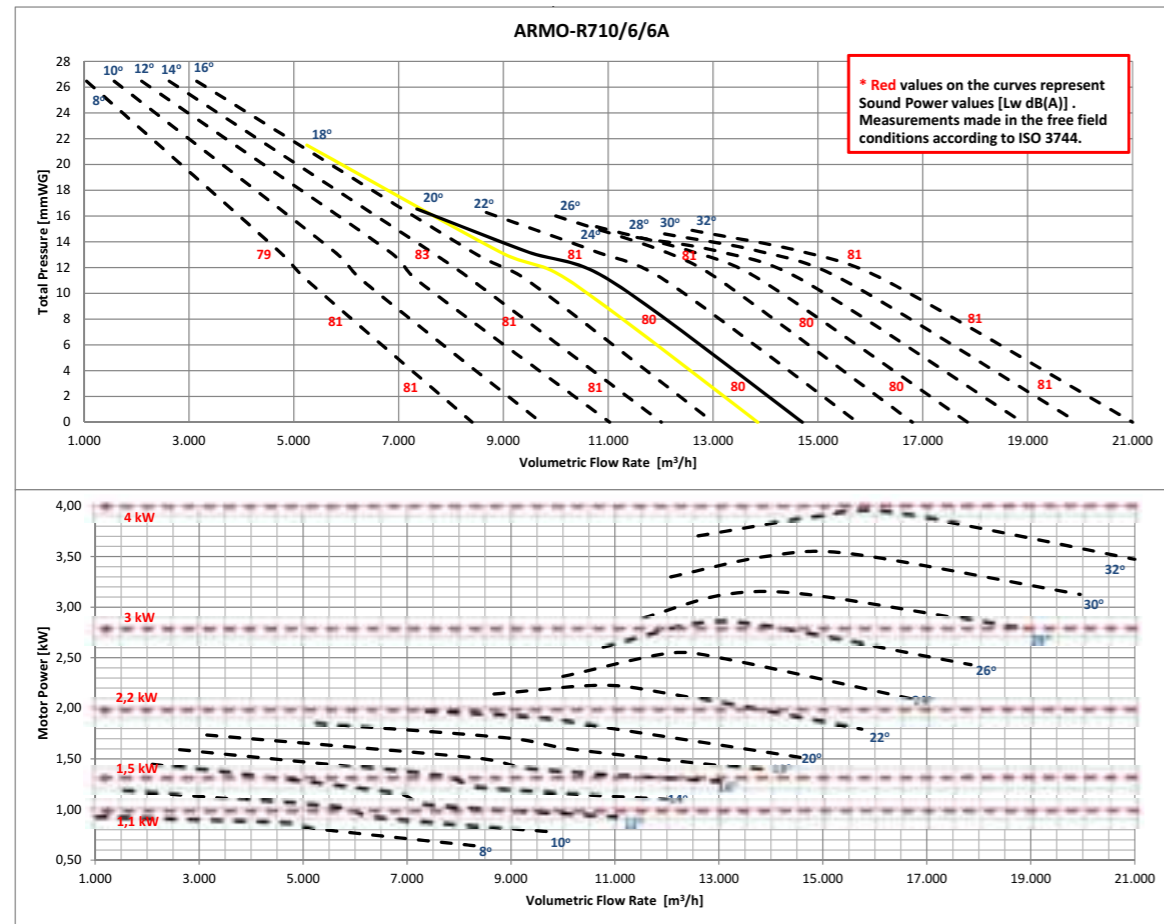

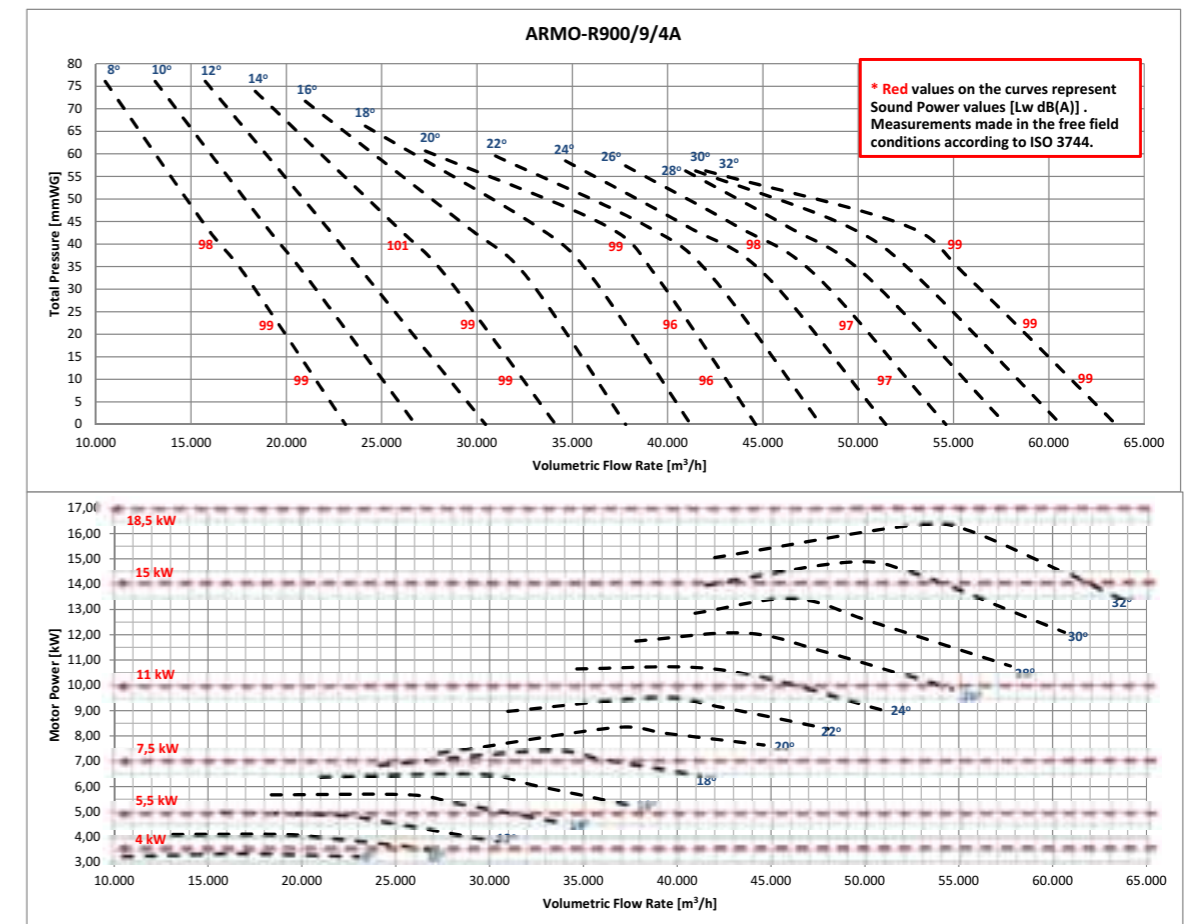
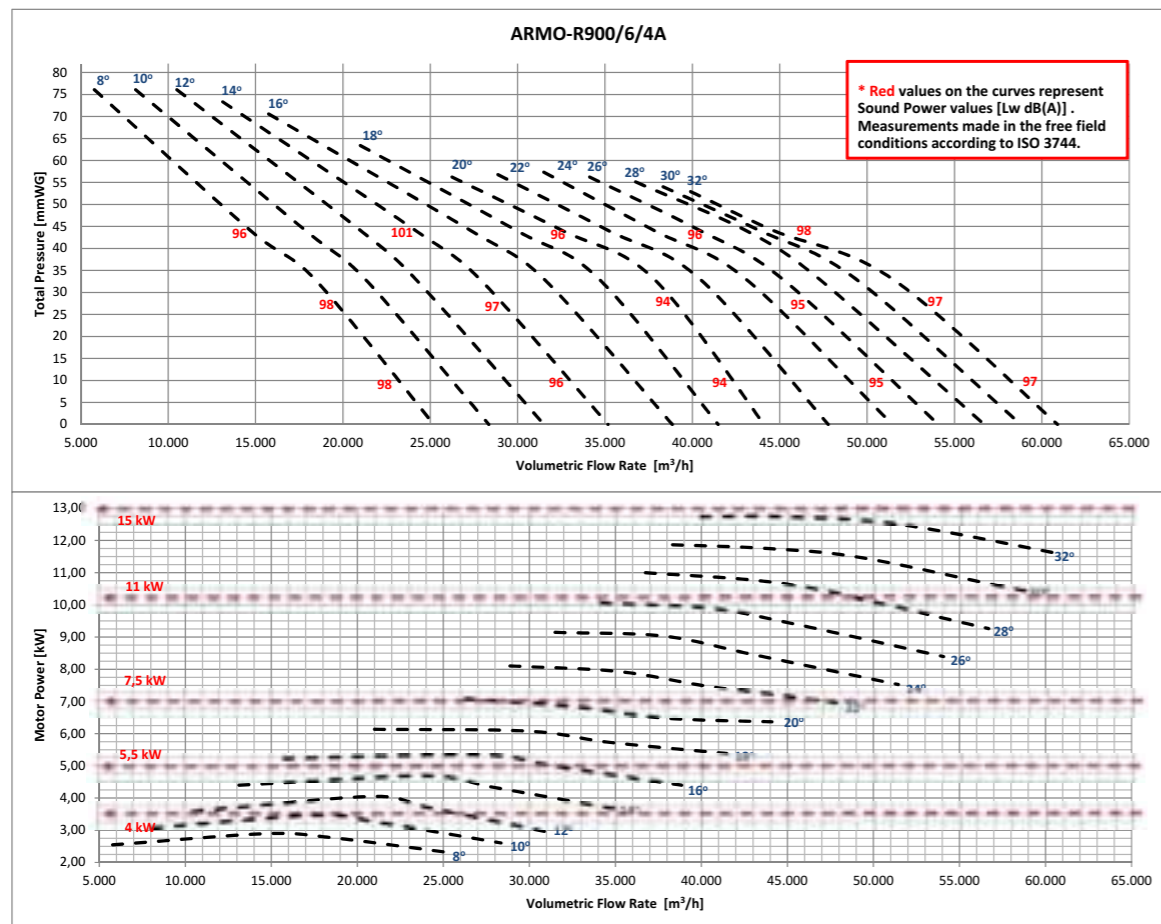
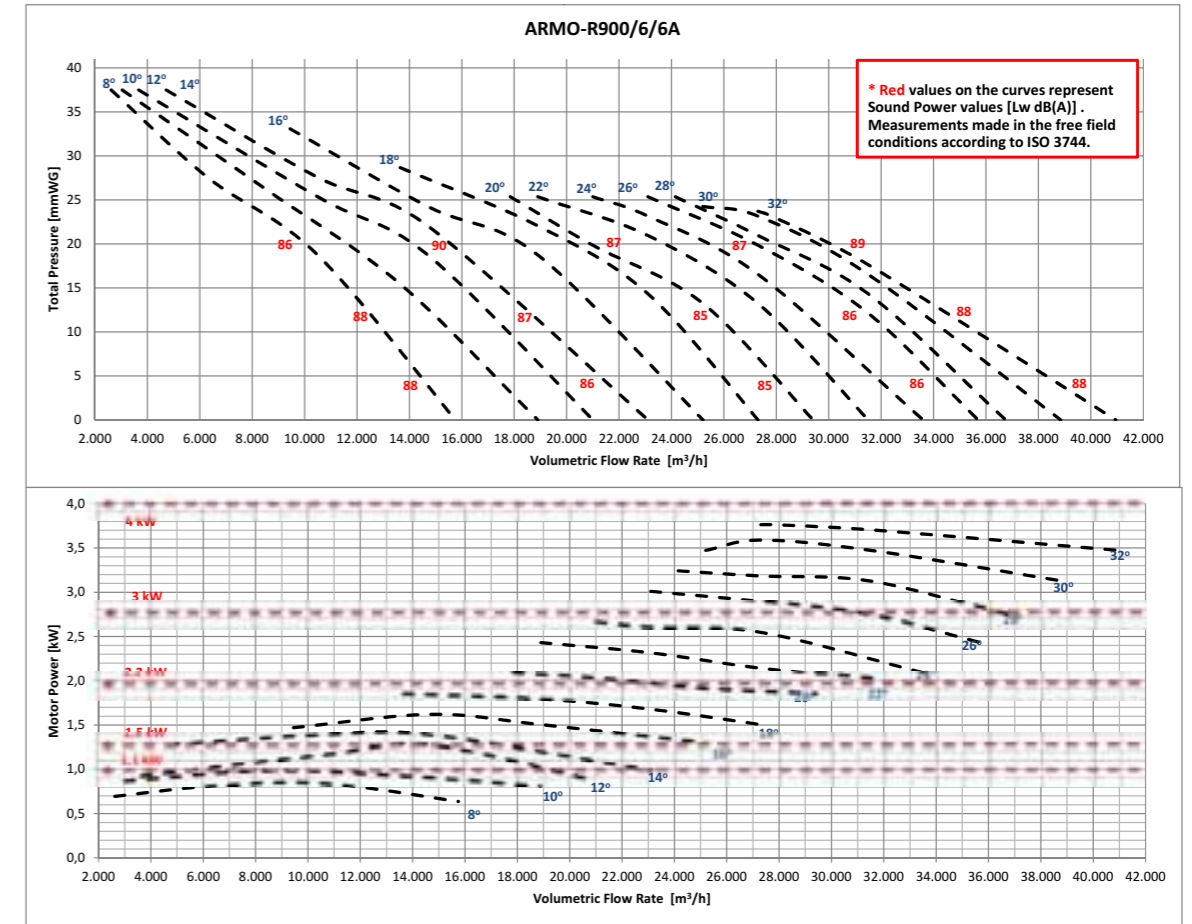
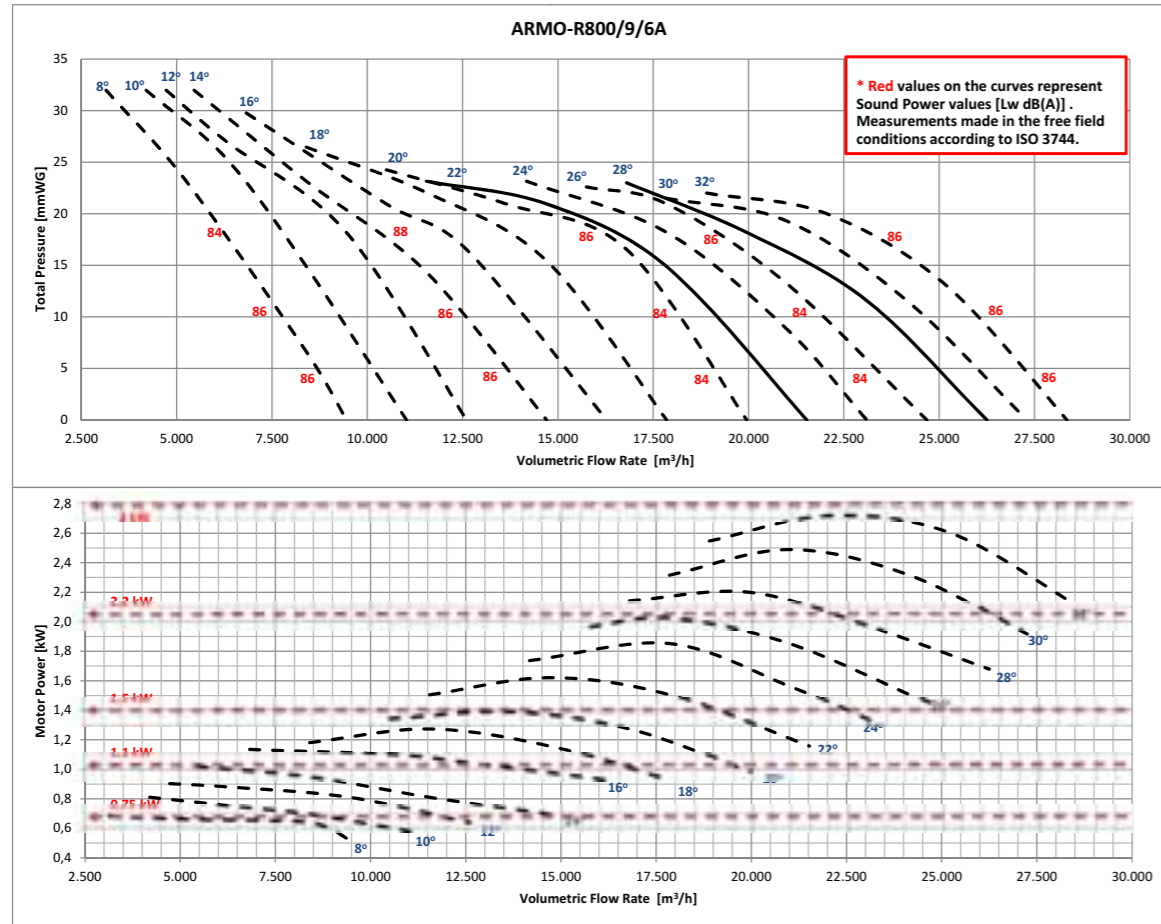

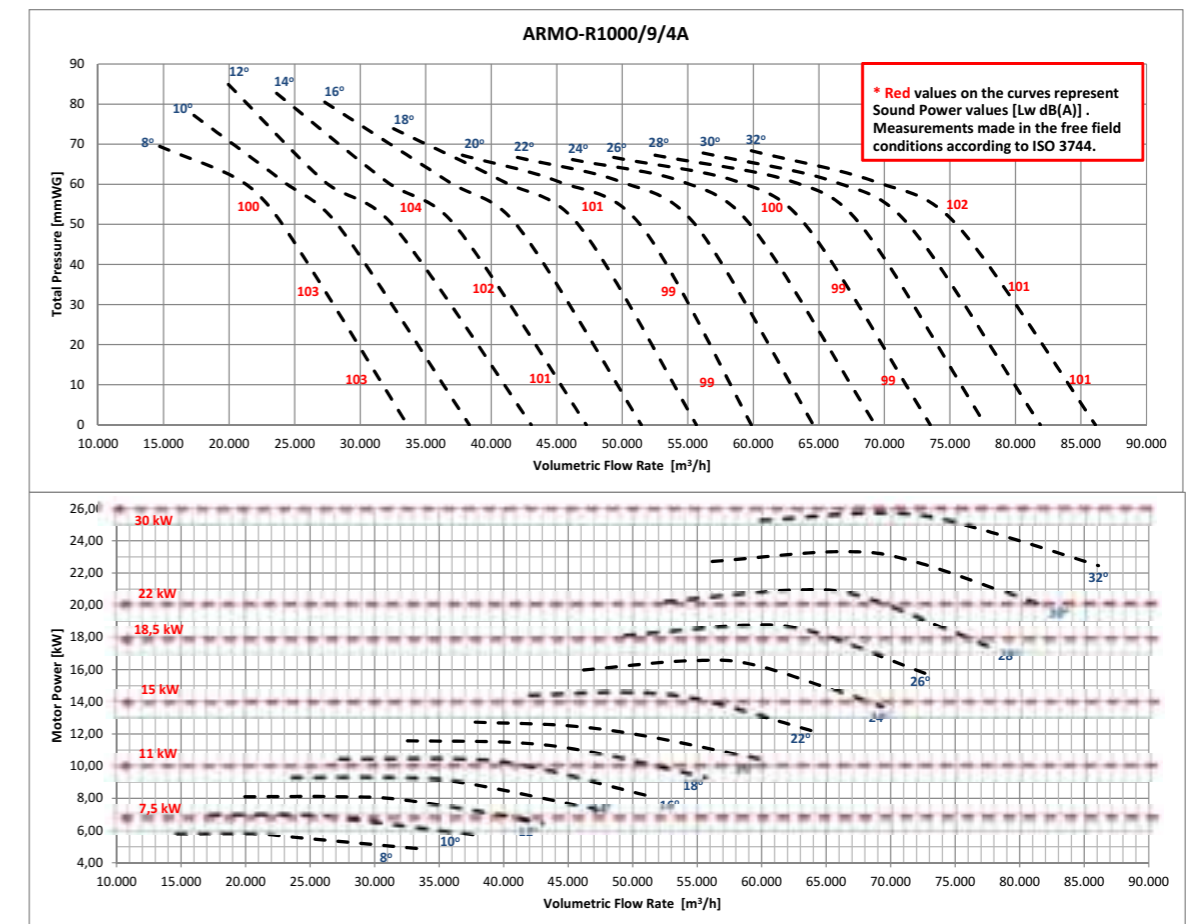
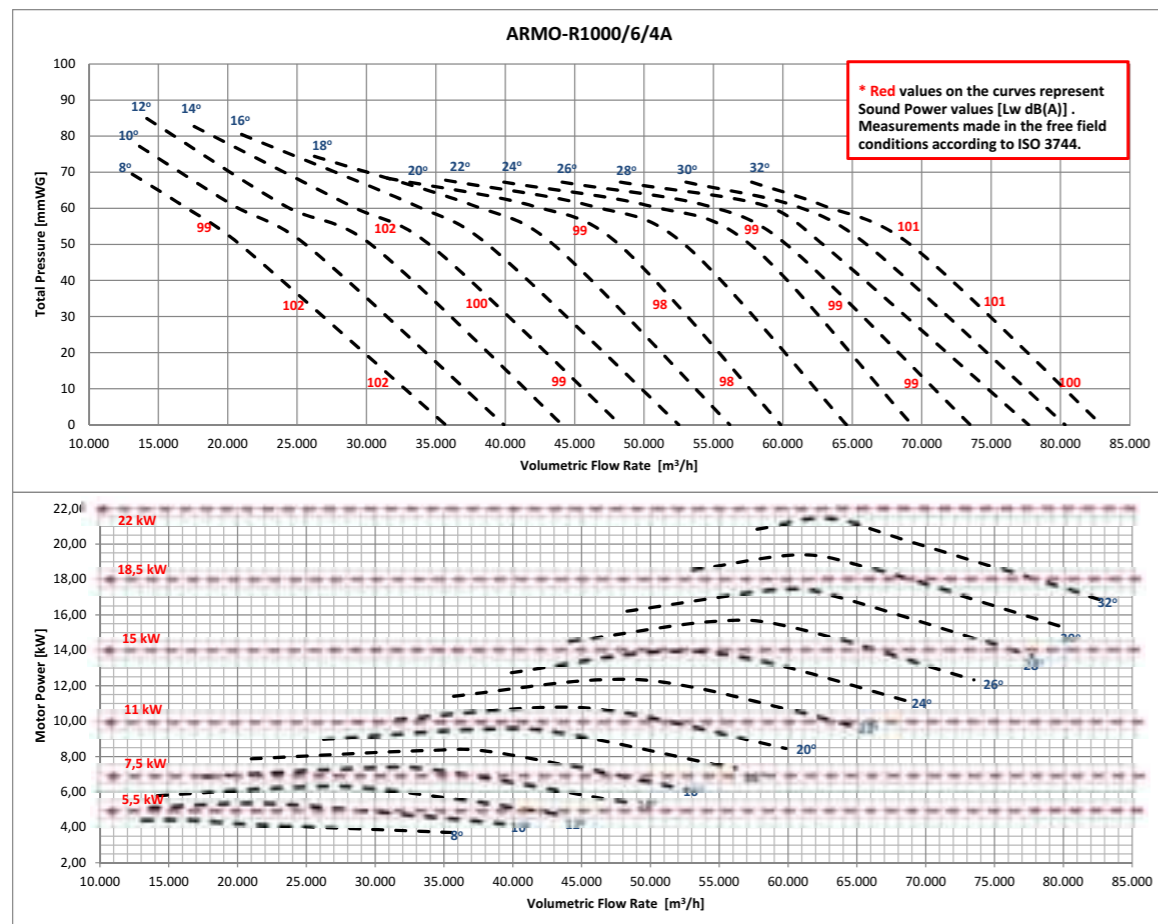
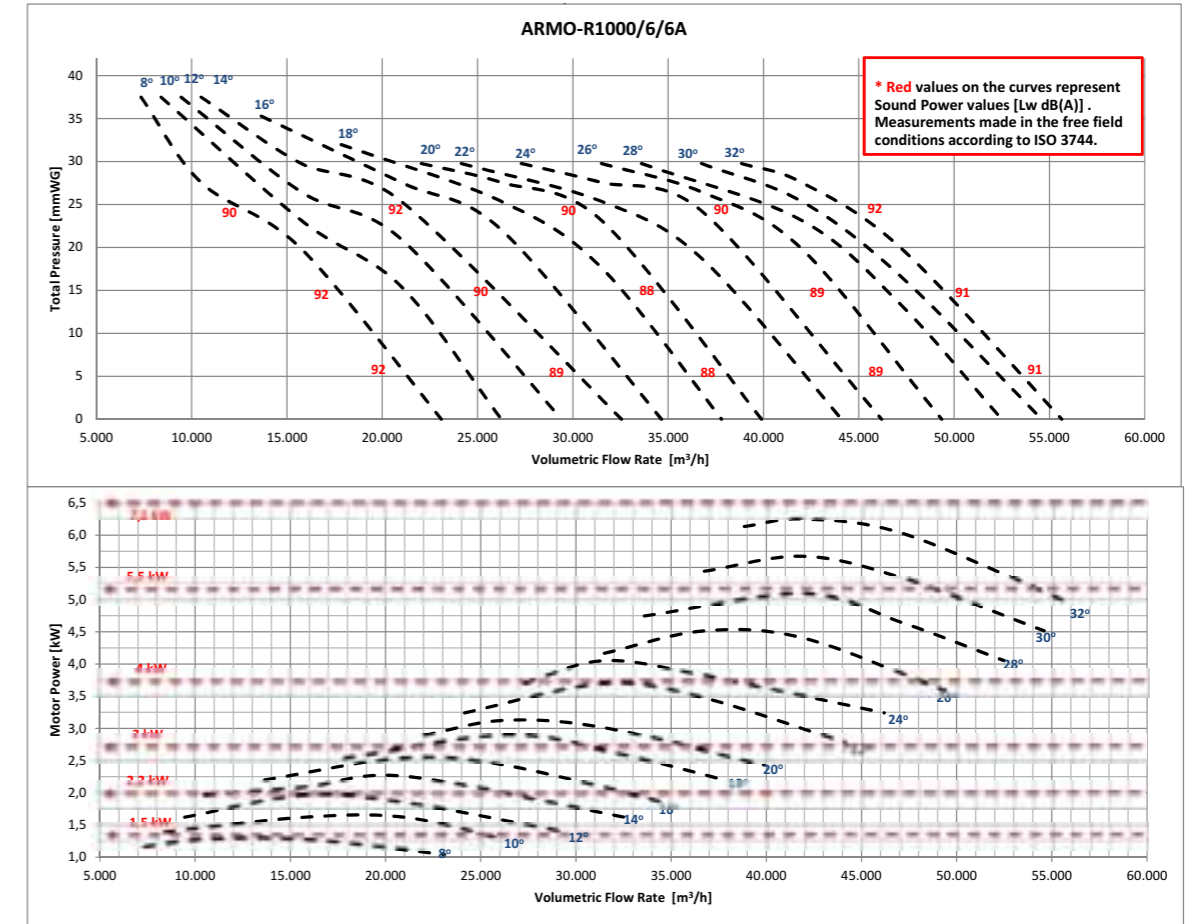
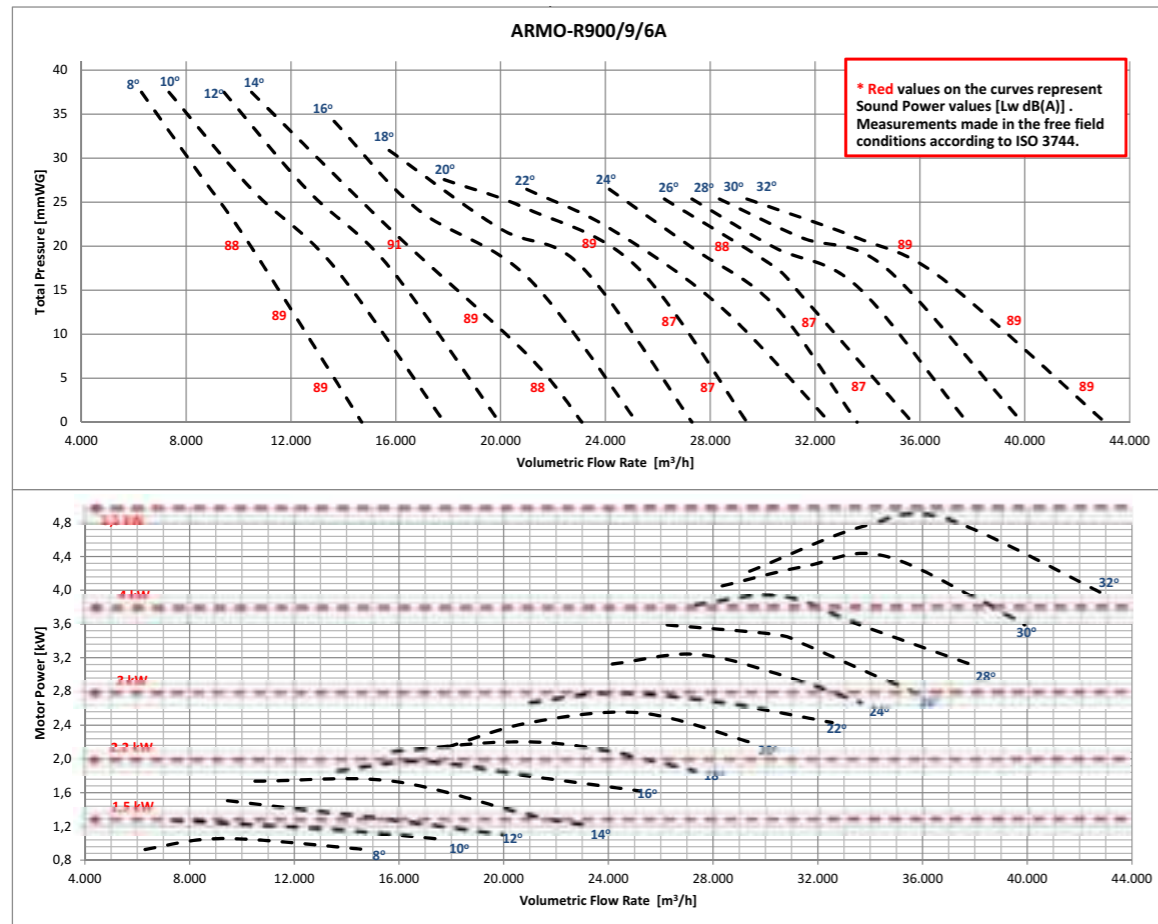

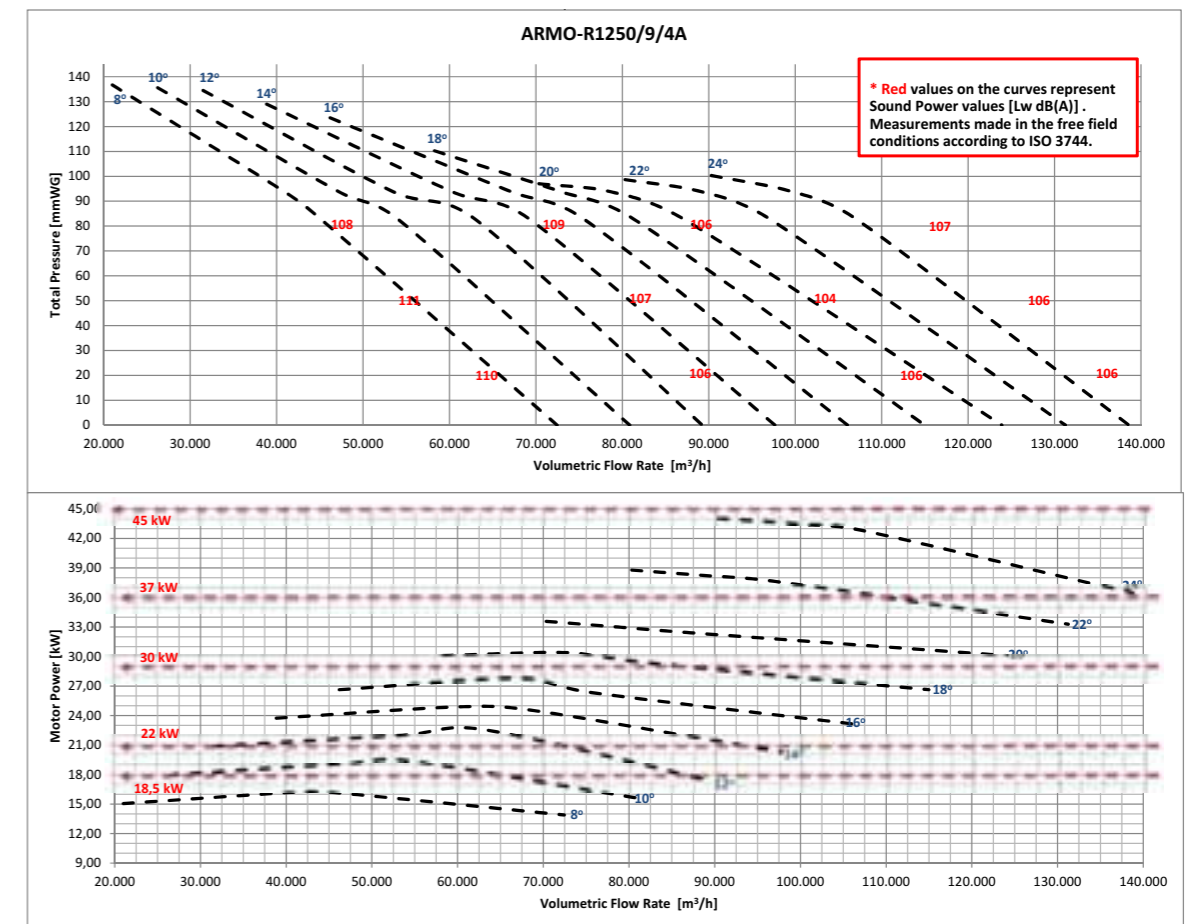
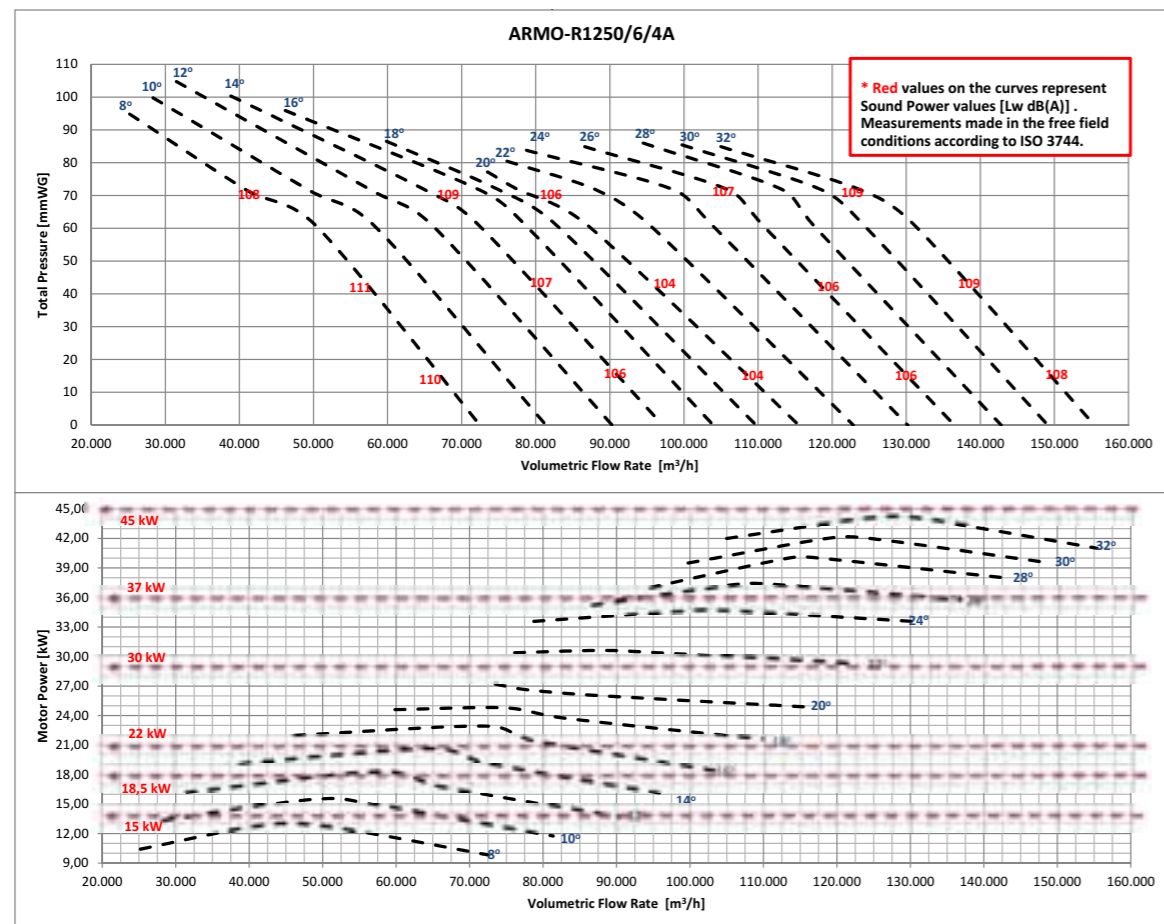
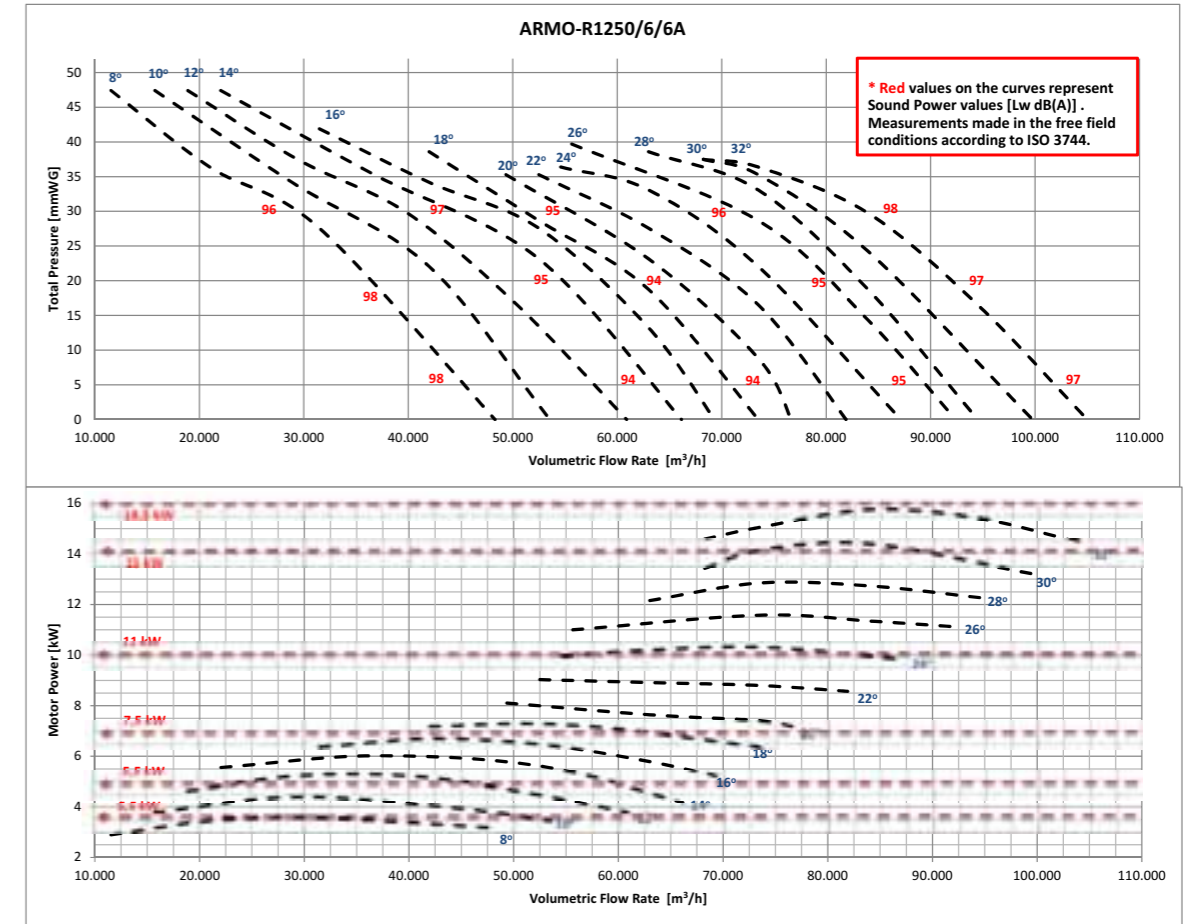
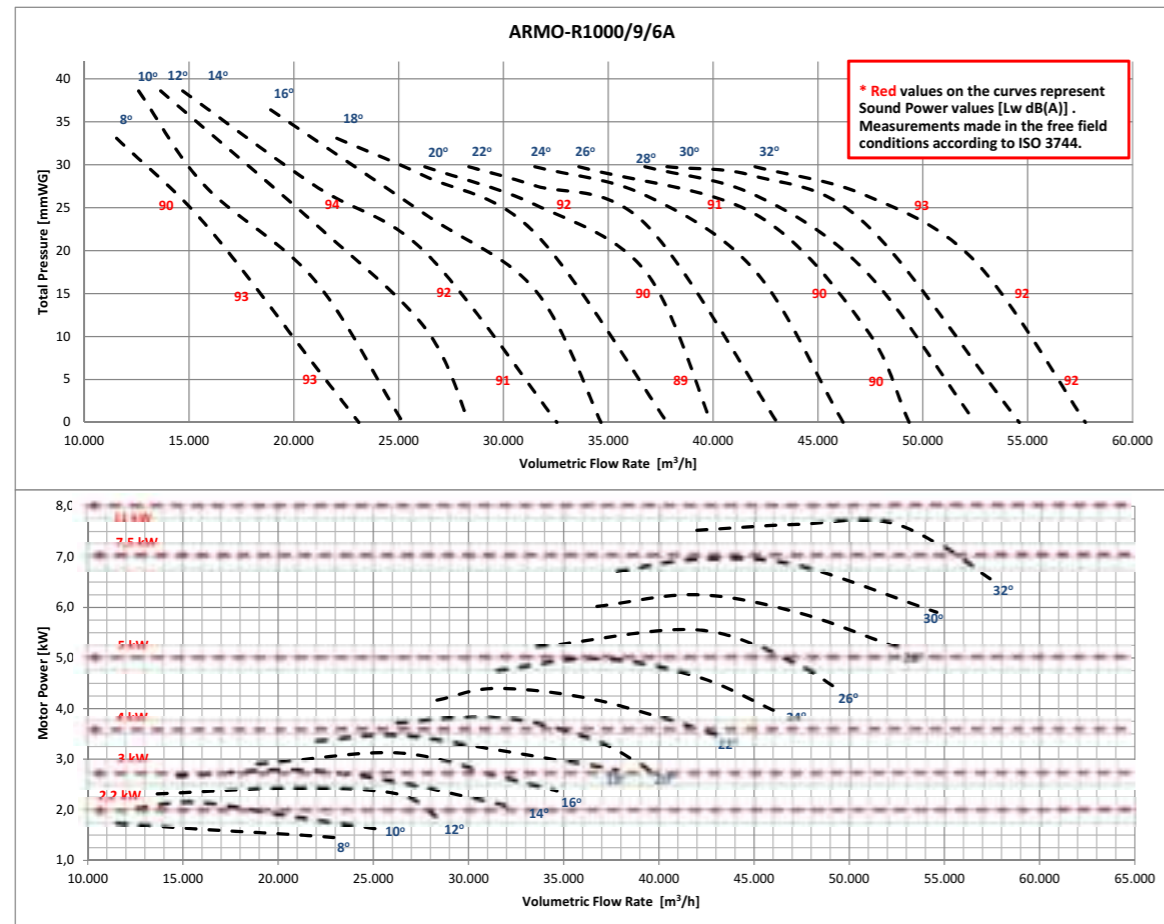

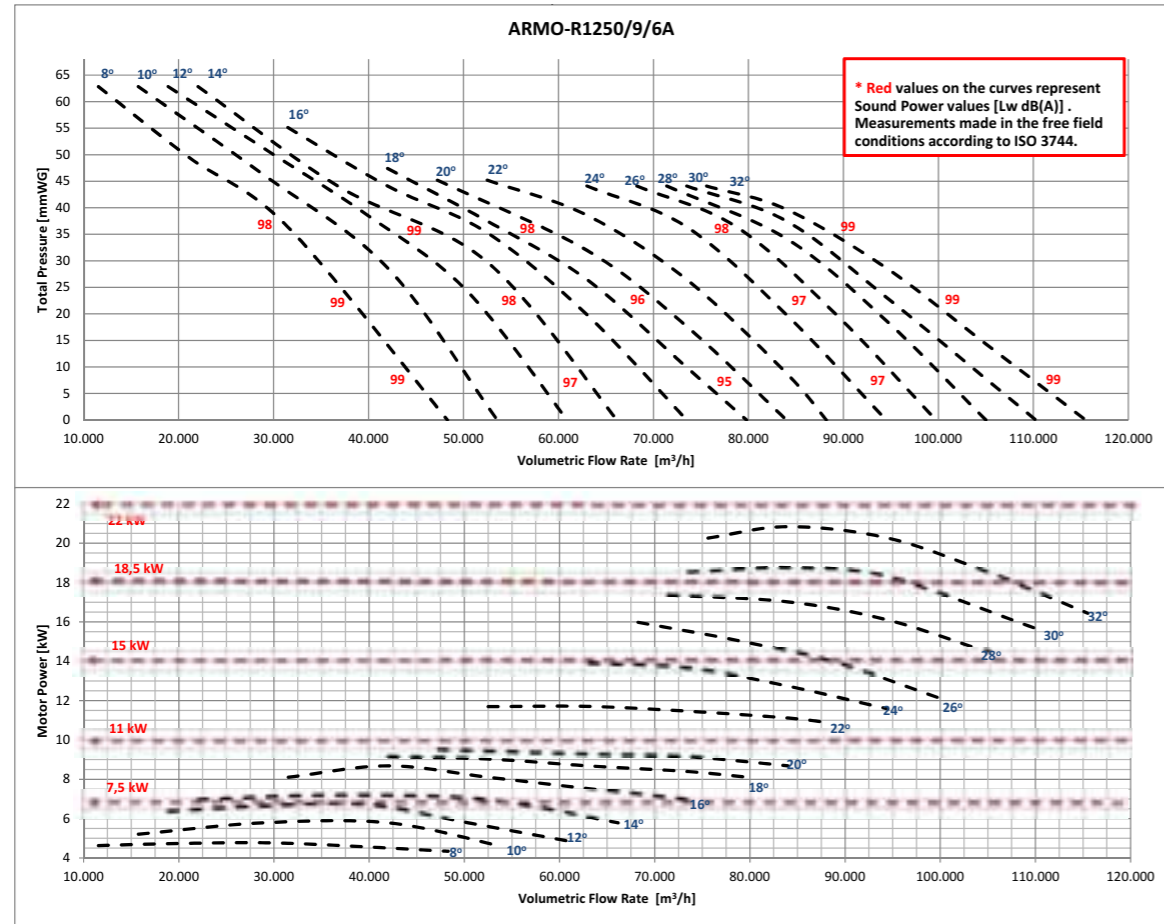

BRF-V

VERTICAL OUTLET ROOF FANS

Fan Components and Material Properties

The BRF-V series of vertical-centric roof-type radial fans are made of galvanized sheet steel with the body, mounting plate and fan wheels of the models BRF-V 225-400. The fan wheels of the BRF 450-500-560 models are made of aluminum sheet. All models have an external rotor motor with closed structure. The device is capable of handling air at max.40°C.

Fan Structure

The fan blades are aerodynamically curved and provide regular flow. The fans are composed of backward sloping and infrequently arranged fins.

Benefits

BRF-V roof fans are particularly advantageous in vertical applications due to the fact that air cannot be absorbed horizontally. Thanks to the aerodynamic wing structure, they work quietly. Speed can be adjusted with speed control devices.

Since the rainwater is easily evacuated, water ingress is prevented from entering the chimney.

Speed Control

Optional control devices can be provided. Speed control can be done with linear voltage regulator in 1~phase products (see BSC accessory). Speed control with frequency inverter can be done in 3~phase products (see BSC-F accessory)

Usage Areas

In order to increase the air quality of indoor spaces, it is used in situations where vertical shot is required under conditions where air cannot be disposed horizontally. The BRF-V roof fans operate at low volume with an external rotor motor. It is used on the roofs of the places where the air is to be re-freshed and the chimneys on the bathroom and wc roofs of the buildings which are opened to the common shaft.

Technical Drawing and Tables

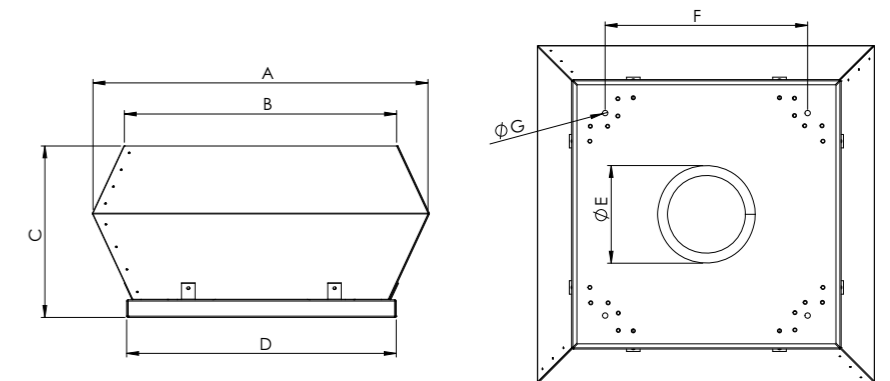

TYPE	A	B	C	D	E	F	G
BRF-V 225	350	295	190	335	146	245	10
BRF-V 315	552	450	330	505	185	450	10
BRF-V 355	745	607	385	595	234	450	10
BRF-V 400	745	607	385	595	270	450	10
BRF-V 450	900	742	512	665	282	630	10
BRF-V 500	900	742	512	665	320	630	12
BRF-V 560	1190	955	595	946	360	740	12

Dimensions are in (mm)

TYPE	VOLTAGE	FREQUENCY	POWER	CURRENT	CAPACITOR	SPEED	AIR FLOW	SOUND PRESSURE	INSULATION CLASS	PROTECTION CLASS	WEIGHT
TYPE	V	Hz	W	(A)	(µF)	r.p.m	m³/h	dB(A)	Ins.cl.	IP	kg
BRF-V 225	230	50/60	160/220	0,71/0,99	6	2650	850	43-35	B	44	7
BRF-V 315	230	50/60	150/175	0,92/0,85	6	1450/1725	1900/2260	45-37	F	44	22
BRF-V 355	230	50/60	200/255	1,1/1,25	8	1400/1600	2850/3250	46-38	F	44	34
BRF-V 400	230	50/60	310/460	1,56/2,27	10	1380/1560	4000/4521	47-39	F	44	39
BRF-V 450	230	50/60	425/630	2,17/3,15	10	1390/1550	5400/6000	50-42	F	44	51
BRF-V 500	380 Δ/Y	50	960/620	2/1,1	-	1400/1050	7600/5700	52-44	F	44	60
BRF-V 560	380 Δ/Y	50	1515/870	2,9/1,7	-	1250/950	9600/7300	60-52	F	44	99

The sound level is measured at a distance of 4-10 m in open field condition.

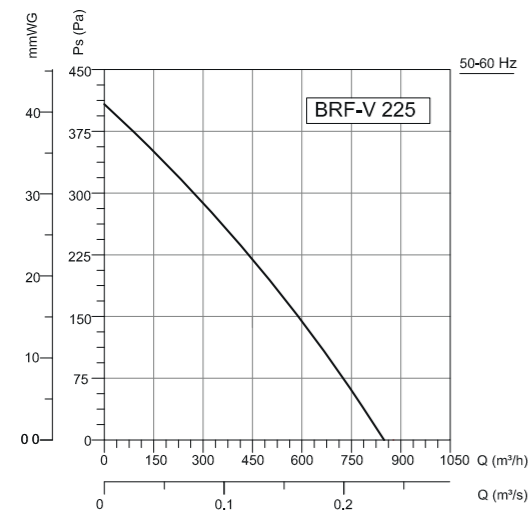

Frequency	Tot	63	125	250	500	1000	2000	4000	8000	Hz
L_{wA} Inlet	65	36	54	58	60	59	56	51	44	dB(A)
L_{wA} Surrounding	66	37	53	59	61	60	57	52	45	dB(A)

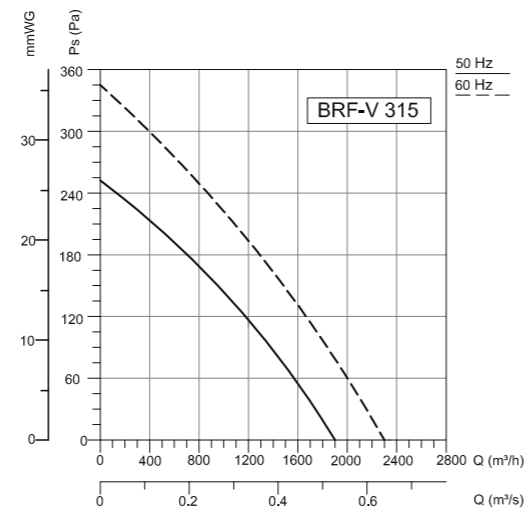

Frequency	Tot	63	125	250	500	1000	2000	4000	8000	Hz
L_{wA} Inlet	68	55	57	61	63	62	59	54	47	dB(A)
L_{wA} Surrounding	70	57	59	63	65	64	61	56	49	dB(A)

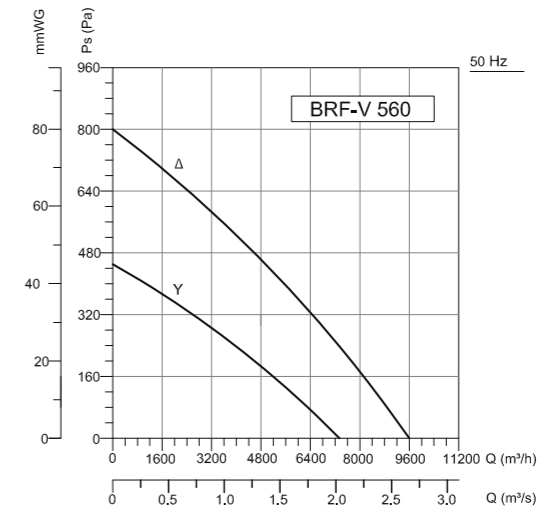

Frequency	Tot	63	125	250	500	1000	2000	4000	8000	Hz
L_{wA} Inlet	81	54	70	74	76	75	71	66	59	dB(A)
L_{wA} Surrounding	83	54	71	75	77	78	74	68	61	dB(A)

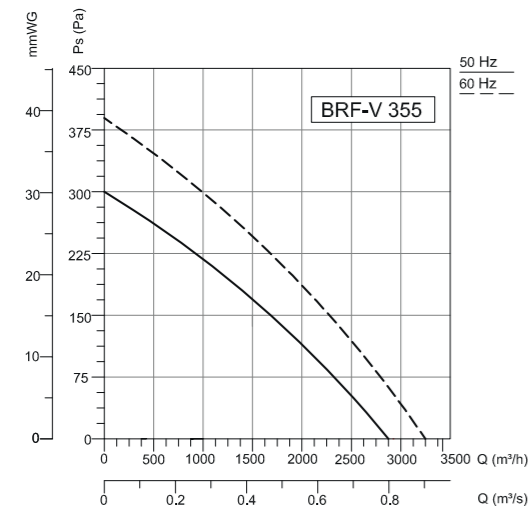

Frequency	Tot	63	125	250	500	1000	2000	4000	8000	Hz
L_{wA} Inlet	67	54	56	60	62	61	58	53	46	dB(A)
L_{wA} Surrounding	69	56	58	62	64	63	60	55	48	dB(A)

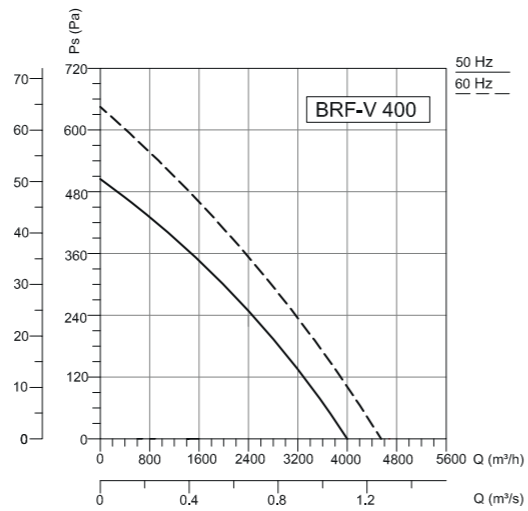

Frequency	Tot	63	125	250	500	1000	2000	4000	8000	Hz
L_{wA} Inlet	71	39	58	66	61	67	54	50	47	dB(A)
L_{wA} Surrounding	70	43	63	62	66	64	57	52	48	dB(A)

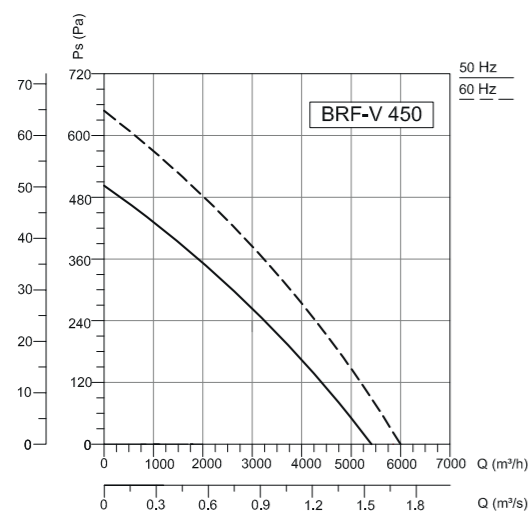

Frequency	Tot	63	125	250	500	1000	2000	4000	8000	Hz
L_{wA} Inlet	68	51	56	63	62	59	57	52	53	dB(A)
L_{wA} Surrounding	73	43	62	64	68	67	62	57	55	dB(A)

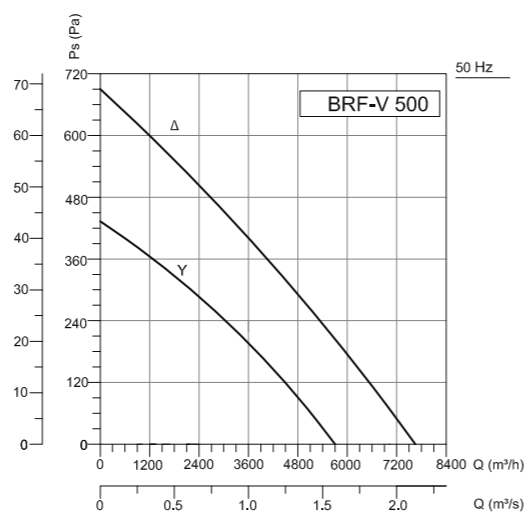

Frequency	Tot	63	125	250	500	1000	2000	4000	8000	Hz
L_{wA} Inlet	73	46	60	70	68	64	61	56	54	dB(A)
L_{wA} Surrounding	75	44	62	66	71	68	66	59	55	dB(A)

Accessories





BRF-V EC

VERTICAL OUTLET ROOF FANS

Fan Components and Material Properties

The BRF-V EC series of vertical-centric roof radial fans are made of galvanized sheet steel. The fan wheels of the BRF 450-500-560 models are made of aluminum sheet. All models are equipped with EC motor with integrated speed control.

Fan Structure

The fan blades are aerodynamically curved and provide regular flow. The fans are composed of backward sloping and infrequently arranged fins.

Benefits

BRF-V roof fans are particularly advantageous in vertical applications due to the fact that air cannot be absorbed horizontally. Thanks to the aerodynamic wing structure, they work quietly. Since the rainwater is easily evacuated, water ingress

is prevented from entering the chimney. With a more efficient motor, system efficiency is increased and lower operating costs are ensured.

Speed Control

With EC motor integrated speed control, the desired speed can be achieved.

Usage Areas

In order to increase the air quality of indoor spaces, it is used in situations where vertical shot is required under conditions where air cannot be disposed horizontally. The BRF-V roof fans operate at low volume with an external rotor motor. It is used on the roofs of the places where the air is to be refreshed and the chimneys on the bathroom and wc roofs of the buildings which are opened to the common shaft.

Technical Drawing and Tables

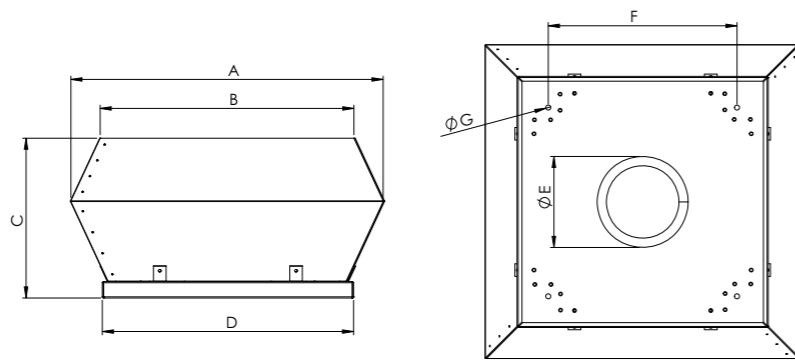
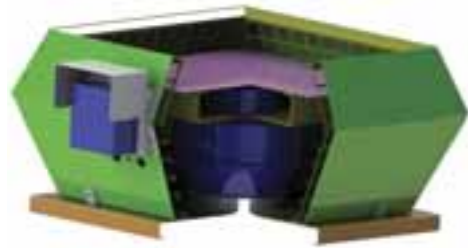

Accessories



TYPE	A	B	C	D	E	F	G
BRF-V EC 315	552	450	330	505	185	450	10
BRF-V EC 355	745	607	385	595	235	450	10
BRF-V EC 400	745	607	385	595	270	450	10
BRF-V EC 450	900	742	512	665	280	630	10
BRF-V EC 500	900	742	512	665	320	630	12
BRF-V EC 560	1190	955	595	946	360	740	12

Dimensions are in (mm)

TYPE	VOLTAGE	FREQUENCY	POWER	CURRENT	SPEED	AIR FLOW	MAX. PRESSURE	SOUND PRESSURE
TYPE	V	Hz	W	(A)	r.p.m	m ³ /h	Pa	dB(A)
BRF-V EC 315	220	50/60	350	1,5	2000	2200	500	45-37
BRF-V EC 355	220	50/60	400	2,1	1850	3500	620	46-38
BRF-V EC 400	220	50/60	420	2,3	1450	4000	600	47-39
BRF-V EC 450	380	50/60	1000	1,5	1450	6500	650	50-42
BRF-V EC 500	380	50/60	870	1,46	1100	7000	450	52-44
BRF-V EC 560	380	50/60	770	1,3	850	8500	320	60-52

Sound Level Measured from 3m distance in room condition.

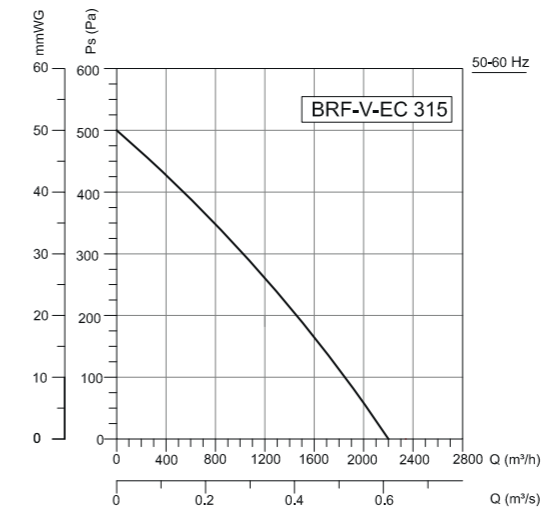

Frequency	Tot	63	125	250	500	1000	2000	4000	8000	Hz
L _{wa} Inlet	68	55	57	61	63	62	59	54	47	dB(A)
L _{wa} Surrounding	70	57	59	63	65	64	61	56	49	dB(A)

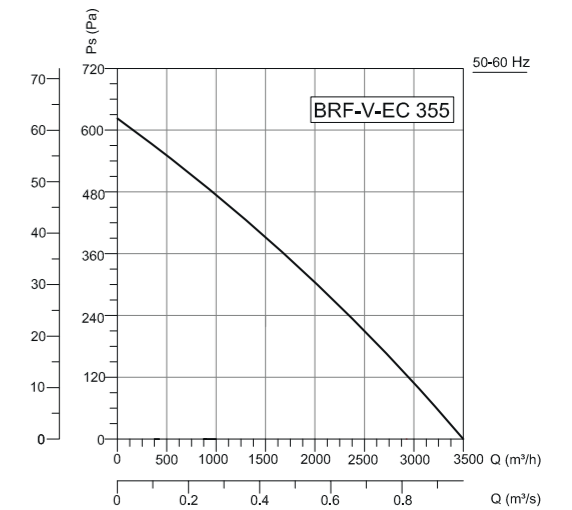

Frequency	Tot	63	125	250	500	1000	2000	4000	8000	Hz
L _{wa} Inlet	67	54	56	60	62	61	58	53	46	dB(A)
L _{wa} Surrounding	69	56	58	62	64	63	60	55	48	dB(A)

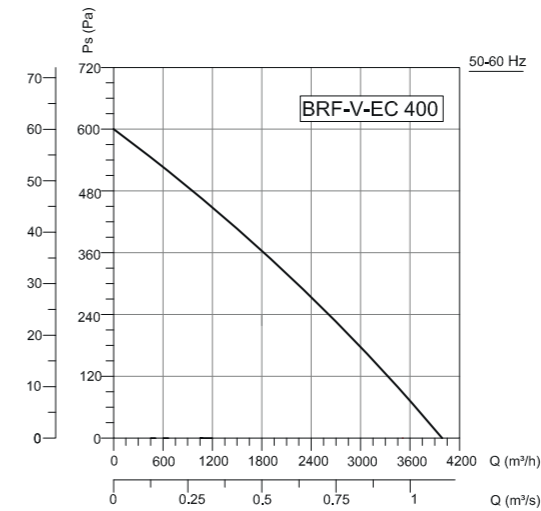

Frequency	Tot	63	125	250	500	1000	2000	4000	8000	Hz
L _{wa} Inlet	71	39	58	66	61	67	54	50	47	dB(A)
L _{wa} Surrounding	70	43	63	62	66	64	57	52	48	dB(A)

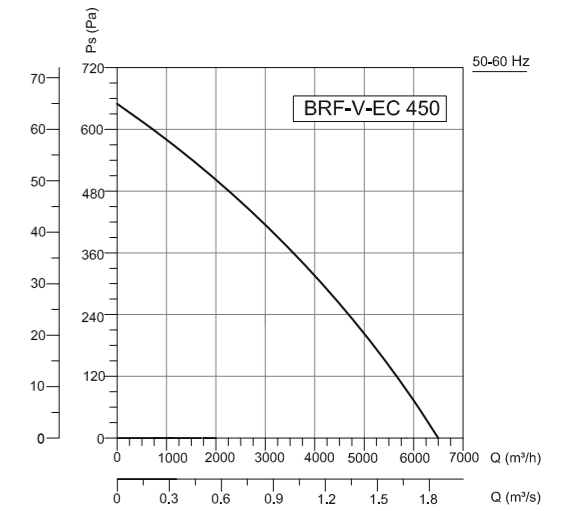

Frequency	Tot	63	125	250	500	1000	2000	4000	8000	Hz
L _{wa} Inlet	68	51	56	63	62	59	57	52	53	dB(A)
L _{wa} Surrounding	73	43	62	64	68	67	62	57	55	dB(A)

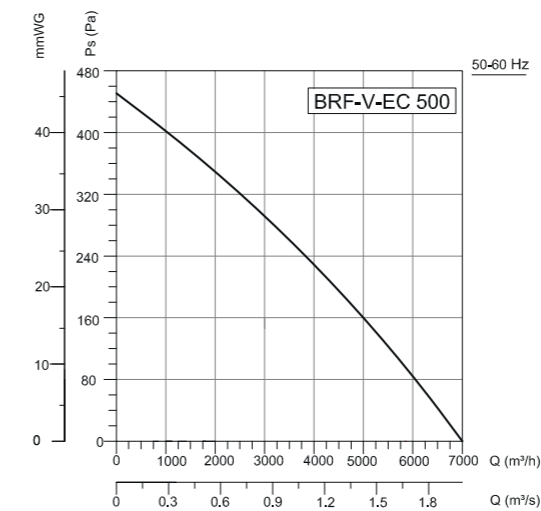

Frequency	Tot	63	125	250	500	1000	2000	4000	8000	Hz
L _{wa} Inlet	73	46	60	70	68	64	61	56	54	dB(A)
L _{wa} Surrounding	75	44	62	66	71	68	66	59	55	dB(A)

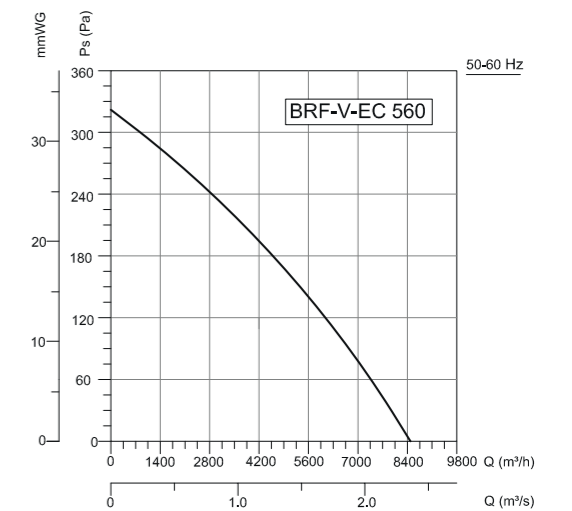

Frequency	Tot	63	125	250	500	1000	2000	4000	8000	Hz
L _{wa} Inlet	81	54	70	74	76	75	71	66	59	dB(A)
L _{wa} Surrounding	83	54	71	75	77	78	74	68	61	dB(A)



BRDV

VERTICAL OUTLET ROOF FANS

Fan Components and Material Properties

The models of BRDV series vertical centrifugal roof fans are manufactured from galvanized sheet steel. The models of BRDV 450-560 are made of aluminum sheet. Asynchronous motor is used in all models. The motor is out of airflow. The device is capable of carrying air at max.120°C.

Fan Structure

The fan blades are aerodynamically curved and provide regular flow. The fans are composed of backward sloping and infrequently arranged fins.

Benefits

BRDV roof fans provide a great advantage in applications with vertical shot feature in conditions where horizontal air is not allowed to be absorbed. Thanks to the aerodynamic wing structure, they work quietly. Speed can be adjusted with speed control devices. Since the rainwater is easily evacuated, water ingress is prevented from

entering the chimney. Since the motor is out of airflow, it is resistant to high temperature. Due to its high temperature resistance, the hot oil vapor absorbed from the hoods ensures a long distance to the vertical.

Speed Control

Optional control devices can be provided. Speed control with frequency inverter can be done in 3-phase products (see BSC-F accessory)

Usage Areas

In order to increase the air quality of indoor spaces, it is used in situations where vertical shot is required under conditions where air cannot be disposed horizontally. The BRF-V roof fans operate at low volume with an external rotor motor. It is used on the roofs of the places where the air is to be refreshed and the chimneys on the bathroom and wc roofs of the buildings which are opened to the common shaft.

Accessories

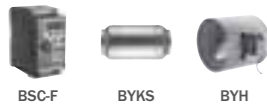

Technical Drawing and Tables

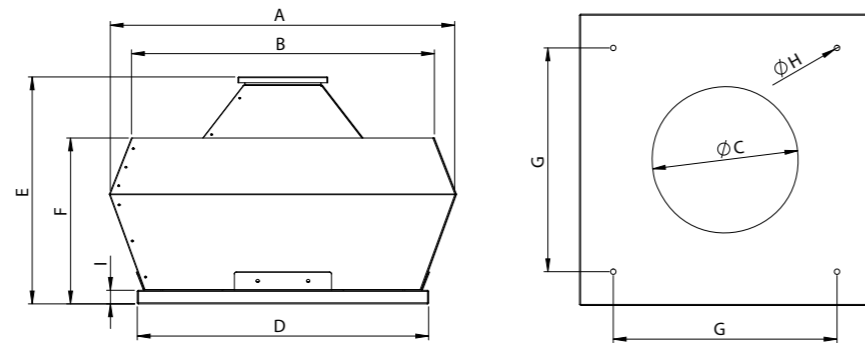

TYPE	A	B	C	D	E	F	G	H	I
BRDV 315	845	740	185	700	550	395	576	14	35
BRDV 355	845	740	235	700	550	395	576	14	35
BRDV 400	895	780	270	750	585	430	576	14	35
BRDV 450	960	855	282	800	595	440	625	14	35
BRDV 500	1030	915	320	850	695	490	675	14	35
BRDV 560	1195	960	360	950	820	610	740	14	35

Dimensions are in (mm)

TYPE	VOLTAGE	FREQUENCY	POWER	CURRENT	CAPACITOR	SPEED	AIR FLOW	SOUND PRESSURE	INSULATION CLASS	PROTECTION CLASS	WEIGHT
TYPE	V	Hz	kW	(A)	(µF)	r.p.m	m³/h	dB(A)	Ins.cl.	IP	kg
BRDV 315M	230	50	0,25	2,1	10	1380	1900	48-40	F	55	22
BRDV 355M	230	50	0,25	2,1	10	1380	2850	50-42	F	55	27
BRDV 400M	230	50	0,37	3,4	15	1390	4000	51-43	F	55	33
BRDV 450M	230	50	0,55	4,5	20	1365	5300	54-46	F	55	38
BRDV 500M	230	50	1,1	7,5	35	1410	8000	56-48	F	55	49
BRDV 560M	230	50	2,2	14,2	50	1420	10500	65-57	F	55	58
BRDV 315T	380	50	0,25	0,87	-	1380	1900	48-40	F	55	22
BRDV 355T	380	50	0,25	0,87	-	1380	2850	50-42	F	55	27
BRDV 400T	380	50	0,37	1,2	-	1390	4000	51-43	F	55	33
BRDV 450T	380	50	0,55	1,6	-	1365	5300	54-46	F	55	38
BRDV 500T	380	50	1,1	2,6	-	1410	8000	56-48	F	55	49
BRDV 560T	380	50	2,2	4,9	-	1420	10500	65-57	F	55	58

The sound level is measured at a distance of 4-10 m in open field condition.

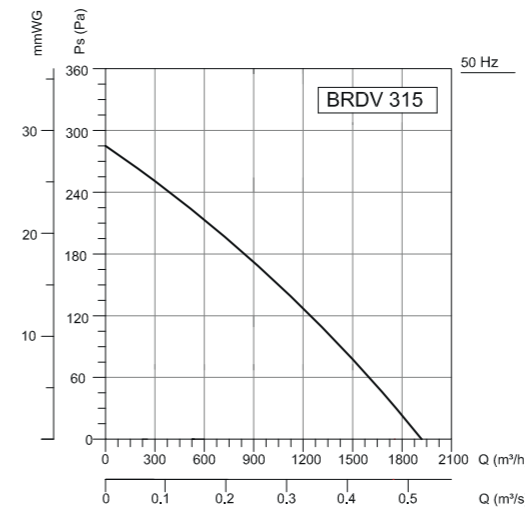

Frequency	Tot	63	125	250	500	1000	2000	4000	8000 Hz
L _{wa} Inlet	69	40	58	62	64	63	60	55	48 dB(A)
L _{wa} Surrounding	71	42	60	64	66	65	62	57	50 dB(A)

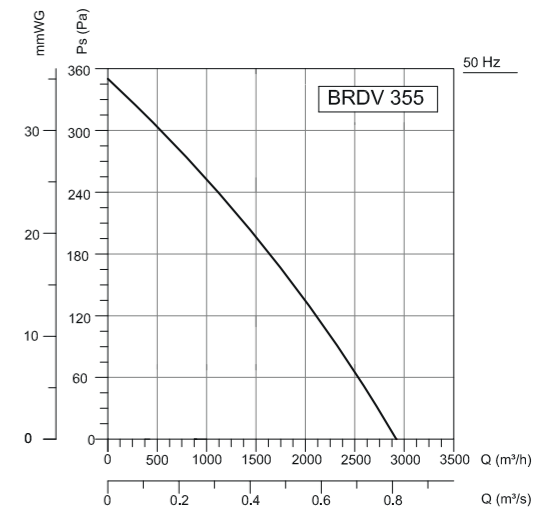

Frequency	Tot	63	125	250	500	1000	2000	4000	8000 Hz
L _{wa} Inlet	71	42	60	64	66	65	62	57	50 dB(A)
L _{wa} Surrounding	73	44	62	66	68	67	64	59	52 dB(A)

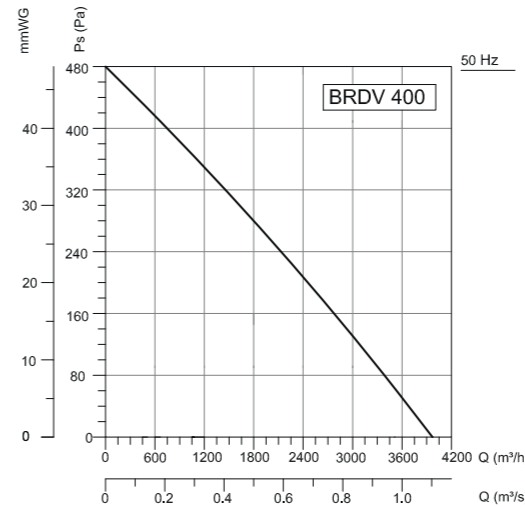

Frequency	Tot	63	125	250	500	1000	2000	4000	8000 Hz
L _{wa} Inlet	72	59	61	65	67	66	63	58	51 dB(A)
L _{wa} Surrounding	74	61	63	67	69	68	65	60	53 dB(A)

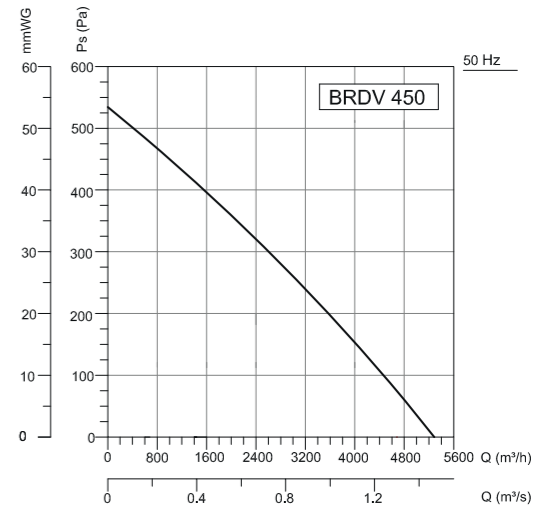

Frequency	Tot	63	125	250	500	1000	2000	4000	8000 Hz
L _{wa} Inlet	75	62	64	68	70	69	66	61	54 dB(A)
L _{wa} Surrounding	77	64	66	70	72	71	68	63	56 dB(A)

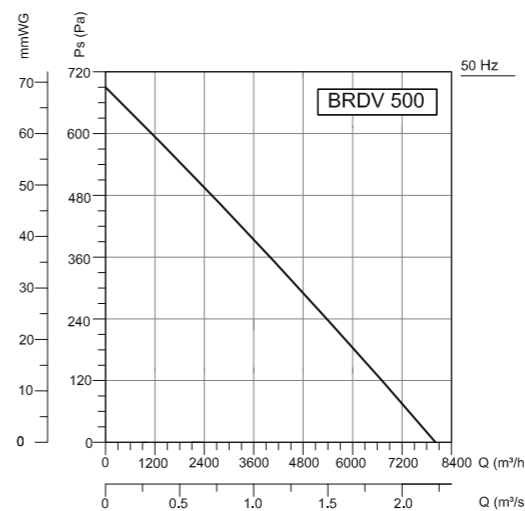

Frequency	Tot	63	125	250	500	1000	2000	4000	8000 Hz
L _{wa} Inlet	72	59	61	65	67	66	63	58	51 dB(A)
L _{wa} Surrounding	79	66	68	73	74	73	70	65	58 dB(A)

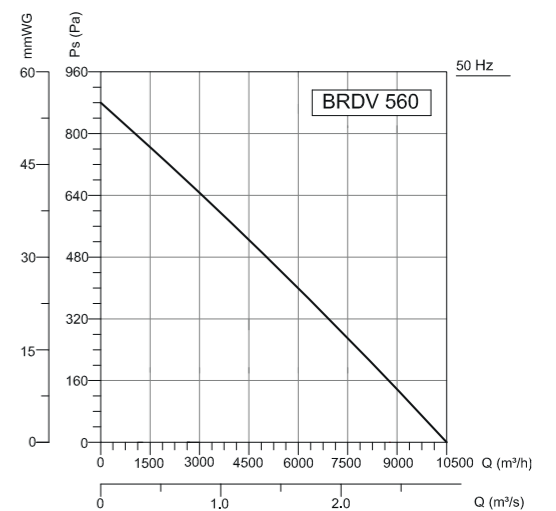

Frequency	Tot	63	125	250	500	1000	2000	4000	8000 Hz
L _{wa} Inlet	86	73	75	79	81	80	77	72	65 dB(A)
L _{wa} Surrounding	88	75	77	81	83	82	79	74	67 dB(A)

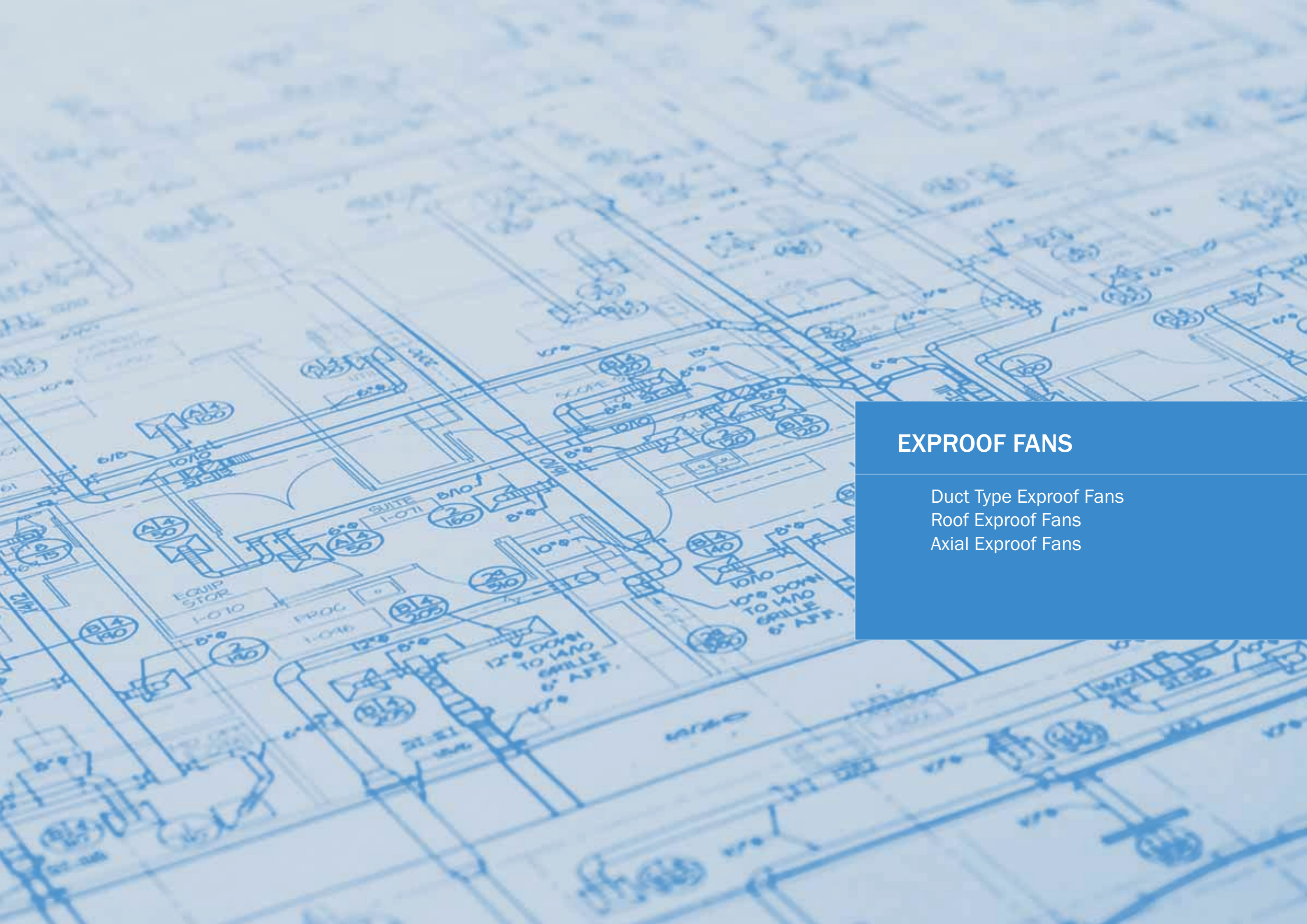

EXPROOF FANS

- Duct Type Exproof Fans
- Roof Exproof Fans
- Axial Exproof Fans

EX-PROOF (ATEX) FANS

In Case of explosive and/or flammable conditions, fans must be ex-proofed according to standards..

The end product user is responsible for evaluating the explosive environment and responsible for using the correct product for an appropriate application and all the equipment used in the explosive environment during installation is approved by an accredited testing laboratory. Fan must be protected against foreign matters that may cause sparks and danger in the airflow. Motor protection relay and transformer must be placed outside the explosive environment. The Manufacturer is only responsible for the craftsmanship of the requested product.

GAS/STEAM	IGNITION TEMPERATURE (°C)
Metane	595
Hydrogen	560
Aseton	465
Ethylene Oxide	430
Ethanol	363
Butane	287
Diethyl Ether	160
Disulfide	102

EX-PROOF FAN SELECTION

When selecting the ATEX fan, the substance to be transported and the corresponding explosion group and temperature class must be selected correctly. For example, Hydrogen IIC explosion group enters T1 Temperature class. Lastly, protection class of the fan must be decided. According to demand, BVN ATEX fans are available with EX e (safety enhanced) and EX d (flameproof) models.

Temperature Class	Ignition Temperature of gas mixes	Maximum surface temperature of the electrical equipment
T1	>450 °C	450 °C
T2	>300...>450 °C	300 °C
T3	>200...>300 °C	200 °C
T4	>135...>200 °C	135 °C
T5	>100...>135 °C	100 °C
T6	>85...>100 °C	85 °C

Gas Groups	I	IIA	IIB	IIC
T1	Methane	Aseton, Ethan, Ammonia, Benzol (pure), acetic acid methan, methanol, Propane Toluene	Coal Gas	Hydrogen
T2		Ethanol, i-Amyl acetate n-Butane, n-Butyl alcohol	Ethylene	Acetylene
T3		Gasoline, Diesel fuel, Aircraft fuel		
T4		Heater fuel, n-hexane		
T5		Acetaldehyde, Ethyl ether		

Producible
Not Available

Region	Equipment Category	Conditions
Zone 0	1G	Long-term explosive gas environment
Zone 1	2G	Occasional explosive gas environment
Zone 2	3G	Very little or abnormal gas environment
Zone 20	1D	Long-term explosive dust environment
Zone 21	2D	Occasional explosive gas environment
Zone 22	3D	Very little or abnormal gas environment

ATEX LABEL INTRODUCTIONS

CE 1783	Ex	II	2G	Ex	e/d	II/IIC	T4	Gb	
CE Sign	Number of responsible organization responsible for manufacturing control and approval	Protection Against Explosion European Union Sign	User determines the ATEX risk analysis: I = Mines II = Other Places, Surface Industry	2 - 2 - Equipment Category 2 = Suitable for zone 1 and zone 2 G = Gas, D = Dust	Ignition Protection Class	e:Safety Enhanced d: Flameproof	Explosion class	Temperature Class	Equipment Protection Level (EPL)





BDKF-R EX PROOF

RECTANGULAR DUCT FANS / Backward Curved

Fan Components and Material Properties

Rectangular body is manufactured from galvanized steel sheet. The fans of the Bdkf-r 315-355-400 are made of high quality galvanized steel which is resistant to corrosion. The fans of the Bdkf-r 450-500-560 models are made of aluminum sheet. All models are equipped with Ex Proof asynchronous motor. Suction flange is made of copper material. The motor is out of airflow. The device is capable of carrying air at max.120°C.

Fan Structure

It is designed to work between the rectangular channel. The fan blades are aerodynamically curved and provide regular flow. The fans are composed of backward sloping and infrequently arranged fins.

Benefits

Designed to be non-sparking. Since the motor is out of airflow, it is resistant to high temperature. The swing-out lid allows the product to be maintained effortlessly without removing the fan. Thanks to the aerodynamic wing structure, they work quietly. Speed can be adjusted with speed control devices.

Usage Areas

Ex-proof fans are one of the preferred fan types for the ventilation of high-risk environments. It is designed to be non-sparking. Usage areas are determined according to the degree of Atex directive.

Technical Drawing and Tables

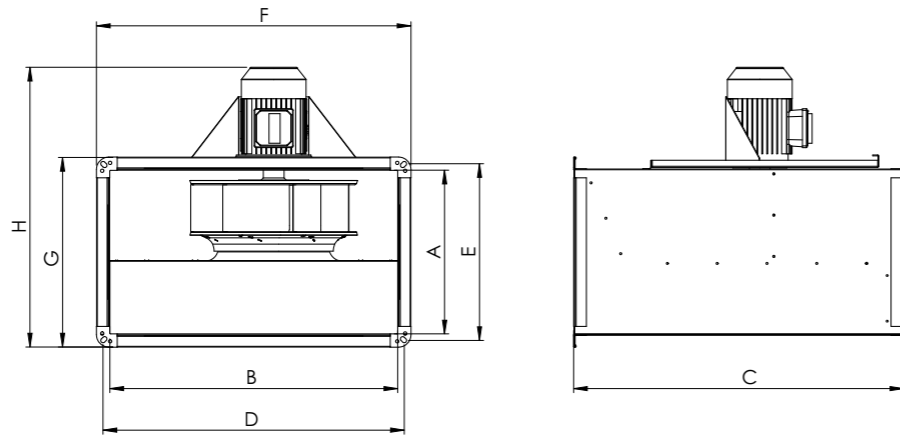

TYPE	A	B	C	D	E	F	G	H
BDKF-R-EX 315 T	350	600	750	620	370	650	400	550
BDKF-R-EX 355 T	350	600	750	620	370	650	400	650
BDKF-R-EX 400 T	400	700	800	720	420	750	450	630
BDKF-R-EX 450 T	400	700	800	720	420	750	450	630
BDKF-R-EX 500 T	500	800	920	820	520	850	560	780
BDKF-R-EX 560 T	500	1000	1050	1030	530	1060	560	780

Dimensions are in (mm)

TYPE	VOLTAGE	FREQUENCY	POWER	CURRENT	CAPACITOR	SPEED	AIR FLOW	SOUND PRESSURE	INSULATION CLASS	PROTECTION CLASS	WEIGHT
TYPE	V	Hz	kW	(A)	(µF)	r.p.m	m³/h	dB(A)	Ins.cl.	IP	kg
BDKF-R-EX 315 T	380	50	0,25	0,87	-	1380	2000	53	F	55	35
BDKF-R-EX 355 T	380	50	0,25	0,87	-	1380	3000	58	F	55	36
BDKF-R-EX 400 T	380	50	0,37	1,2	-	1390	4100	56	F	55	49
BDKF-R-EX 450 T	380	50	0,55	1,6	-	1395	5500	58	F	55	52
BDKF-R-EX 500 T	380	50	1,1	2,6	-	1410	8100	64	F	55	74
BDKF-R-EX 560 T	380	50	2,2	4,9	-	1420	10500	66	F	55	91

Sound Level Measured from 3m distance in room condition.

Accessories

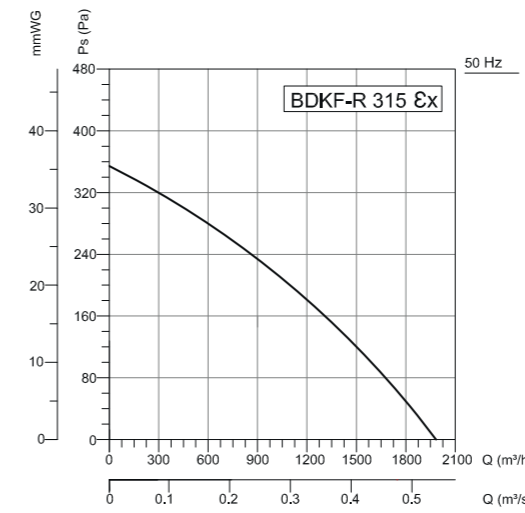

Frequency	Tot	63	125	250	500	1000	2000	4000	8000	Hz
L _{wa} Inlet	70	50	65	61	63	60	61	56	48	dB(A)
L _{wa} Outlet	76	54	72	68	69	68	67	62	54	dB(A)
L _{wa} Surrounding	60	27	57	53	50	49	48	49	37	dB(A)

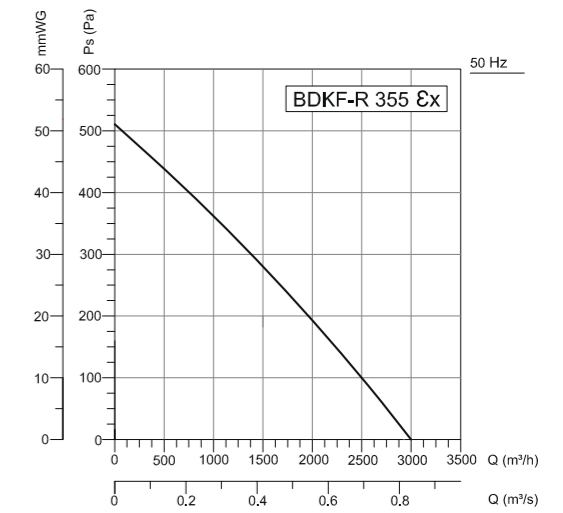

Frequency	Tot	63	125	250	500	1000	2000	4000	8000	Hz
L _{wa} Inlet	74	50	61	67	65	68	66	63	60	dB(A)
L _{wa} Outlet	78	51	61	69	71	71	73	67	70	dB(A)
L _{wa} Surrounding	65	33	40	59	57	59	58	50	47	dB(A)

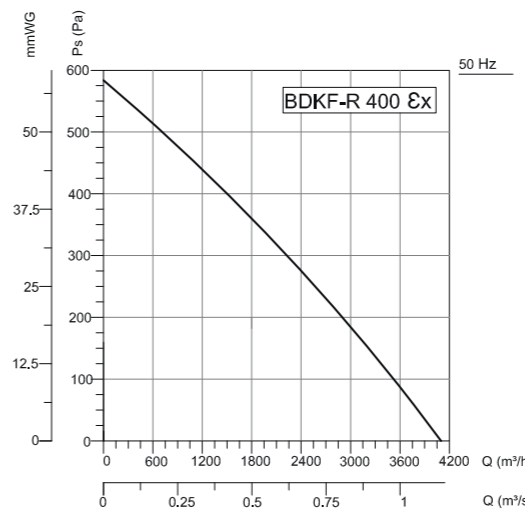

Frequency	Tot	63	125	250	500	1000	2000	4000	8000	Hz
L _{wa} Inlet	73	58	68	64	66	66	62	56	50	dB(A)
L _{wa} Outlet	77	62	68	70	71	71	69	61	55	dB(A)
L _{wa} Surrounding	63	40	60	57	52	51	46	38	35	dB(A)

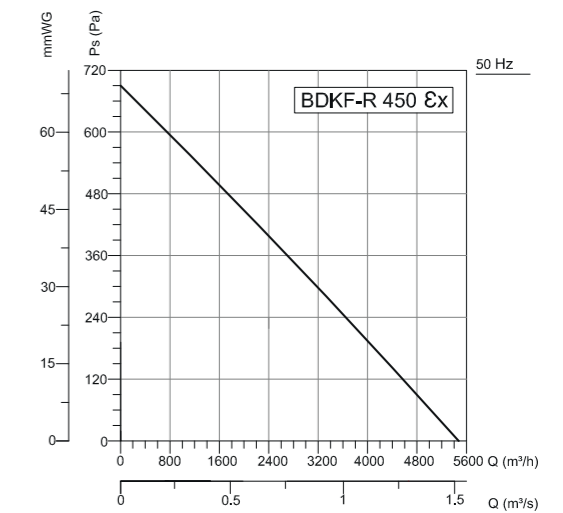

Frequency	Tot	63	125	250	500	1000	2000	4000	8000	Hz
L _{wa} Inlet	70	50	65	61	63	60	61	56	48	dB(A)
L _{wa} Outlet	76	54	72	68	69	68	67	62	54	dB(A)
L _{wa} Surrounding	60	27	57	53	50	49	48	49	37	dB(A)

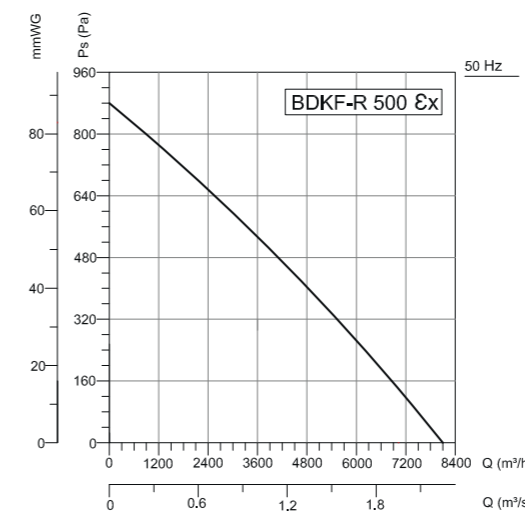

Frequency	Tot	63	125	250	500	1000	2000	4000	8000	Hz
L _{wa} Inlet	79	61	72	71	73	71	71	66	58	dB(A)
L _{wa} Outlet	84	66	75	76	77	79	75	70	61	dB(A)
L _{wa} Surrounding	71	45	68	64	61	61	60	54	43	dB(A)

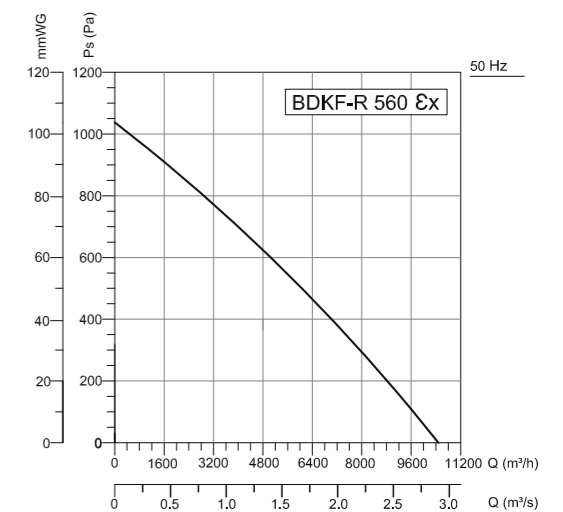

Frequency	Tot	63	125	250	500	1000	2000	4000	8000	Hz
L _{wa} Inlet	84	70	77	76	78	78	75	71	65	dB(A)
L _{wa} Outlet	89	71	80	81	82	83	80	74	65	dB(A)
L _{wa} Surrounding	73	58	70	65	63	61	58	54	50	dB(A)



BRCF-EX PROF

HORIZONTAL OUTLET ROOF FANS / **Backward Curved**

Fan Components and Material Properties

BRCF series vertical flush roof centrifugal fans Body, mounting plate and models of BRCF-EX 280-400 fan impellers made of galvanized sheet steel Made of powder coated sheet steel. The suction funnel is brass plated. Asynchronous ex-proof motor is used in all models. The motor is out of airflow. The device is capable of carrying air at max.120°C.

Fan Structure

The fan blades are aerodynamically curved and provide regular flow. The fans are composed of backward sloping and infrequently aligned fins with the insertion technique, while the fan wheels of the models BRCF 630-800 are manufactured from the necessity of high strength. Direct drive, backward curved and sparse blade

Benefits

BRCF roof fans provide a great advantage in applications with vertical shot feature, especially in conditions where horizontal air is not absorbed.

Thanks to the aerodynamic wing structure, they work quietly. Speed can be adjusted with speed control devices. Since the motor is out of airflow, it is resistant to high temperature. Due to its high temperature resistance, the hot oil vapor absorbed from the hoods ensures a long distance to the vertical. The motor's ex-proof feature ensures safe exhaustion of air in hazardous environments due to the fact that the aluminum and copper parts in the housing prevent electrostatic precipitation.

Speed Control

Optional control devices can be provided. Speed control with frequency inverter can be done in 3-phase products (see BSC-F accessory)

Usage Areas

Ex-proof fans or ex-proof fans are one of the preferred fan types for the ventilation of high-risk environments. It is designed to be non-sparking. Usage areas are determined according to the degree of Atex directive.

Technical Drawing and Tables

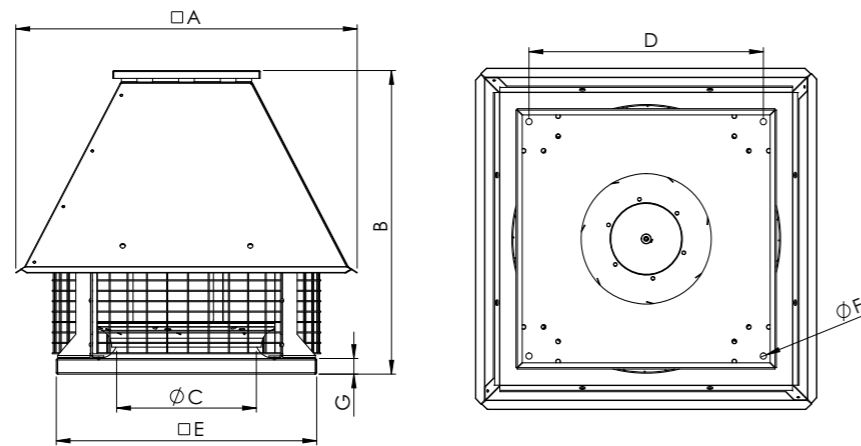

TYPE	A	B	C	D	E	F	G
BRCF-EX 280T	522	495	165	354	404	10	30
BRCF-EX 315T	595	555	198	404	454	10	30
BRCF-EX 355T	656	555	234	450	500	10	30
BRCF-EX 400T	656	585	268	450	500	12	30
BRCF-EX 450T	656	616	303	530	580	12	44
BRCF-EX 500T	766	660	342	590	640	12	44
BRCF-EX 560T	828	723	380	650	700	12	44
BRCF-EX 630T	997	922	445	660	730	12	54
BRCF-EX 710T	1095	991	500	710	780	12	54
BRCF-EX 800T	1205	1172	542	850	900	12	54

Dimensions are in (mm)

Accessories

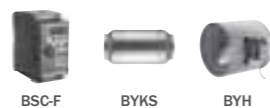

BSC-F BYKS BYH

TYPE	VOLTAGE	FREQUENCY	POWER	CURRENT	SPEED	AIR FLOW	SOUND PRESSURE	INSULATION CLASS	PROTECTION CLASS	WEIGHT
	V	Hz	kW	(A)	r.p.m	m³/h	dB(A)	Ins.cl.	IP	kg
BRCF-EX 280T	380	50	0,25	0,87	1380	1000	53-45	F	55	35
BRCF-EX 315T	380	50	0,25	0,87	1380	1950	53-45	F	55	42
BRCF-EX 355T	380	50	0,25	0,87	1380	2900	55-47	F	55	50
BRCF-EX 400T	380	50	0,37	1,2	1390	4000	60-52	F	55	55
BRCF-EX 450T	380	50	0,55	1,6	1365	5550	62-54	F	55	62
BRCF-EX 500T	380	50	1,1	2,6	1410	8300	64-56	F	55	68
BRCF-EX 560T	380	50	2,2	4,9	1420	10800	66-58	F	55	75
BRCF-EX 630T	380	50	3	6,6	1000	13000	60-52	F	55	127
BRCF-EX 710T	380	50	4	8,4	1000	15000	63-55	F	55	150
BRCF-EX 800T	380	50	7,5	15,4	1000	17000	67-59	F	55	216

Sound Level Measured from 3m distance in room condition.

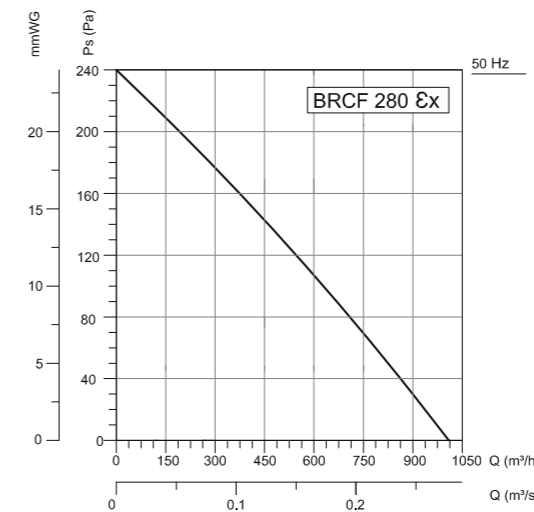

Frequency	Tot	63	125	250	500	1000	2000	4000	8000	Hz
L _{WA} Inlet	74	45	63	67	69	68	65	60	53	dB(A)
L _{WA} Surrounding	76	47	65	69	71	70	67	62	55	dB(A)

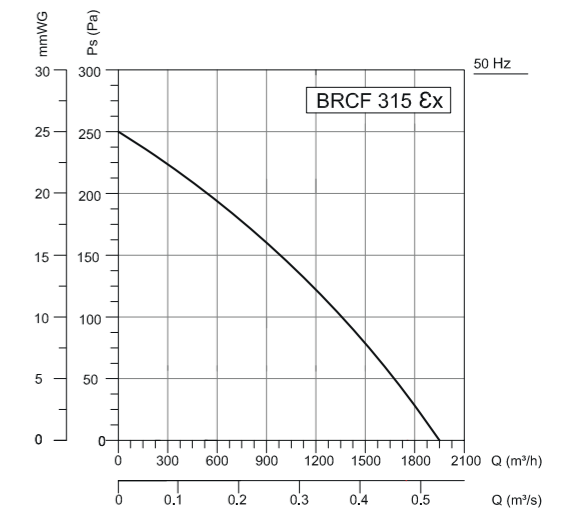

Frequency	Tot	63	125	250	500	1000	2000	4000	8000	Hz
L _{WA} Inlet	74	46	63	68	69	68	64	59	55	dB(A)
L _{WA} Surrounding	76	45	66	70	70	71	67	63	55	dB(A)

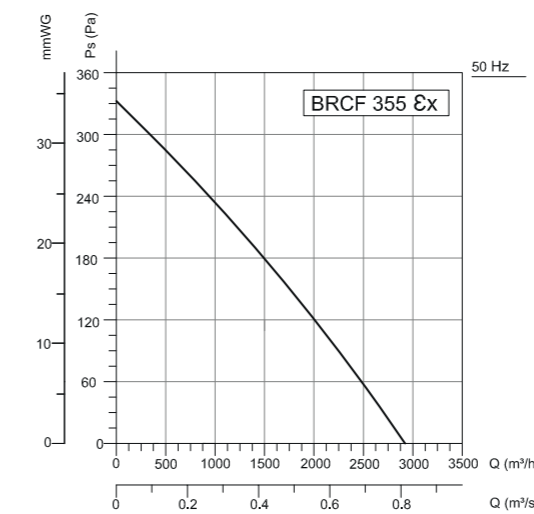

Frequency	Tot	63	125	250	500	1000	2000	4000	8000	Hz
L _{WA} Inlet	76	47	65	69	71	70	67	62	55	dB(A)
L _{WA} Surrounding	78	49	67	69	73	72	69	64	57	dB(A)

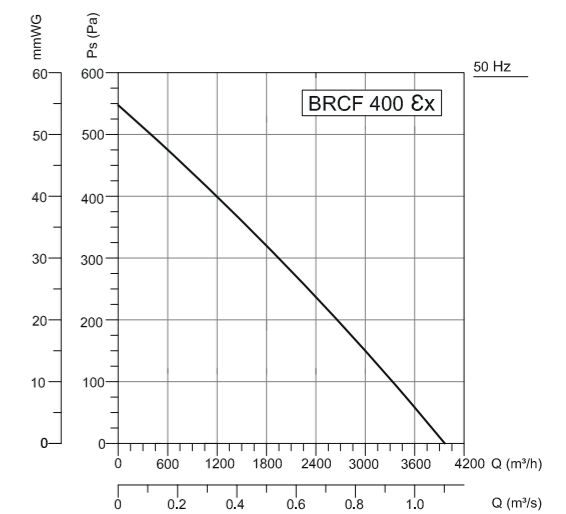

Frequency	Tot	63	125	250	500	1000	2000	4000	8000	Hz
L _{WA} Inlet	81	68	69	74	76	75	72	68	60	dB(A)
L _{WA} Surrounding	83	70	72	76	78	77	74	69	62	dB(A)

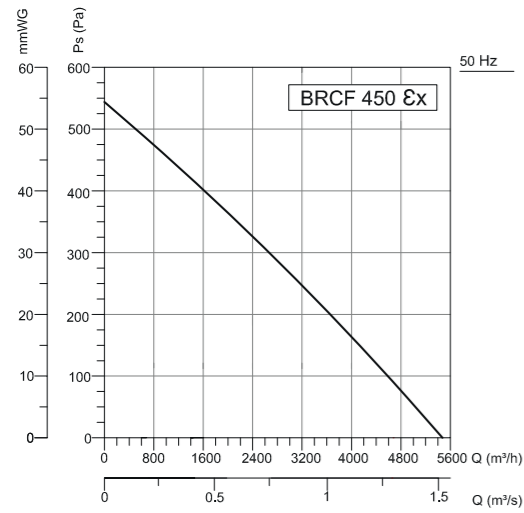

Frequency	Tot	63	125	250	500	1000	2000	4000	8000	Hz
L _{wa} Inlet	82	69	73	75	77	76	73	68	63	dB(A)
L _{wa} Surrounding	85	73	73	77	79	78	75	70	73	dB(A)

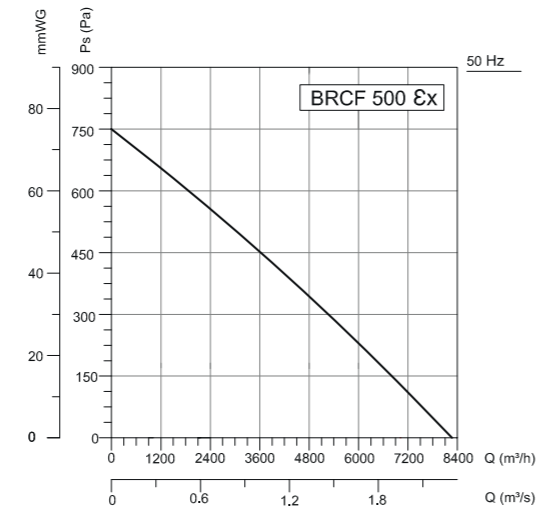

Frequency	Tot	63	125	250	500	1000	2000	4000	8000	Hz
L _{wa} Inlet	82	67	69	73	75	74	71	76	59	dB(A)
L _{wa} Surrounding	87	74	76	81	82	81	78	73	66	dB(A)

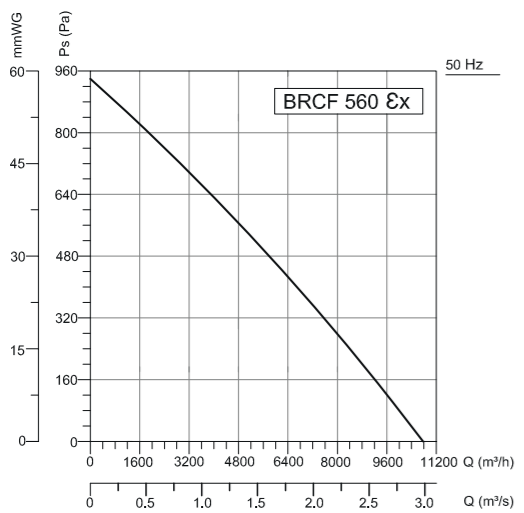

Frequency	Tot	63	125	250	500	1000	2000	4000	8000	Hz
L _{wa} Inlet	87	74	76	80	82	81	78	73	66	dB(A)
L _{wa} Surrounding	89	76	78	82	84	83	80	75	68	dB(A)

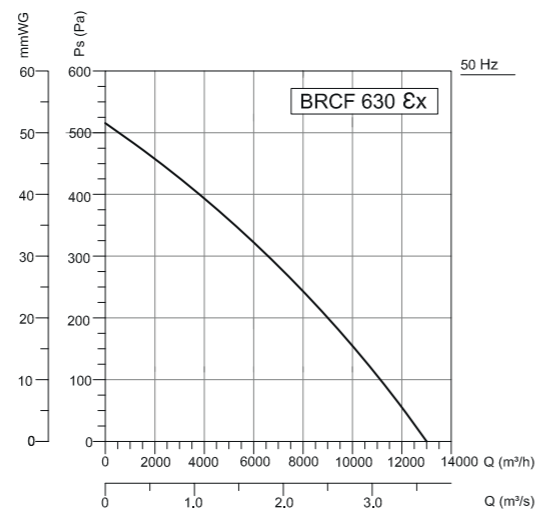

Frequency	Tot	63	125	250	500	1000	2000	4000	8000	Hz
L _{wa} Inlet	80	67	70	73	75	74	71	66	60	dB(A)
L _{wa} Surrounding	83	69	72	75	78	76	73	68	57	dB(A)

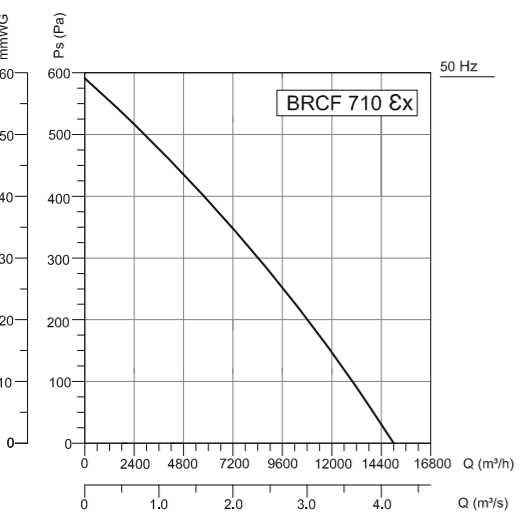

Frequency	Tot	63	125	250	500	1000	2000	4000	8000	Hz
L _{wa} Inlet	83	70	73	76	78	77	74	69	63	dB(A)
L _{wa} Surrounding	86	72	75	78	81	79	76	71	60	dB(A)

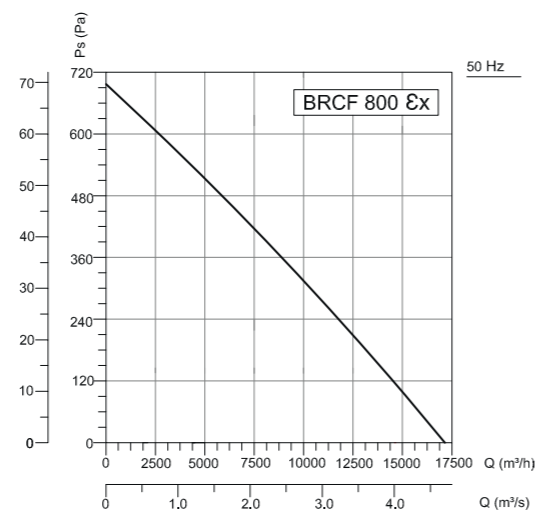

Frequency	Tot	63	125	250	500	1000	2000	4000	8000	Hz
L _{wa} Inlet	88	75	77	81	83	82	79	74	67	dB(A)
L _{wa} Surrounding	90	77	79	83	85	84	81	76	69	dB(A)





BTFM-EX

AXIAL EXPROOF FANS

Fan Components and Material Properties

Cylindrical tube casing, airfoil wing structure and direct coupled motor fans with 3500 m³ / h flow rate of 115000 m³ / h and Ø400 mm -Ø1250 mm 16 models are available in the range options. Body is made of steel with electrostatic powder coating. The motor and fan impeller are connected to the main body by steel carriers. In the case of friction due to the body around the propeller, aluminum sheet is used to prevent sparks. Asynchronous ex-proof motor is used in all models. The motor is out of airflow. It can be manufactured with foot on request.

Fan Structure

Axial wings are produced in pressurized aluminum casting and airfoil structure. The aerodynamically optimized wings provide high efficiency.

Benefits

It works with low noise levels and is designed to be maintenance-free for long periods of time. Speed can be adjusted with speed control devices. The wings are manufactured at the ideal angle and in the form of wings and provide maximum performance.

Speed Control

Optional control devices can be provided. 3-phase products with frequency inverter speed control can be done. (see BSC-F accessory)

Usage Areas

Ex-proof fans or ex-proof fans are one of the preferred fan types for the ventilation of high-risk environments. It is designed to be non-sparking. Usage areas are determined according to the degree of Atex directive.

Technical Drawing and Tables

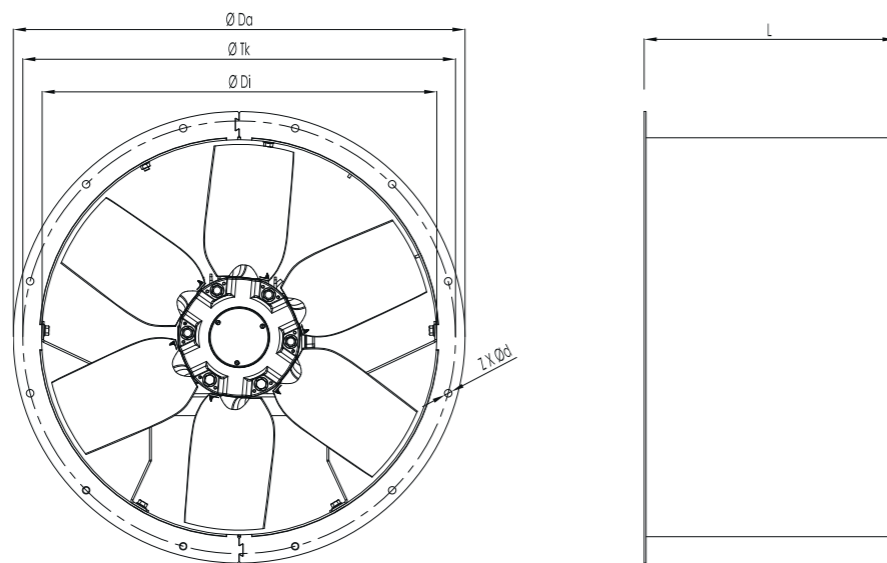

TYPE	ØDi	ØDa	ØTk	ØL	ZXØD
BTFM 400	400	480	450	350	8X12
BTFM 450	450	530	500	350	8X12
BTFM 500	500	590	560	400	12X12
BTFM 560	560	650	620	400	12X12
BTFM 630	630	720	690	400	12X12
BTFM 710	710	800	770	450	16X12
BTFM 800	800	890	860	500	16X12
BTFM 900	900	1005	970	550	16X15
BTFM 1000	1000	1105	1070	700	16X15
BTFM 1250	1250	1390	1320	850	20X15

Dimensions are in (mm)

Accessories



TYPE	VOLTAGE	FREQUENCY	POWER	CURRENT	CAPACITOR	SPEED	AIR FLOW	SOUND PRESSURE	INSULATION CLASS	PROTECTION CLASS
	V	Hz	kW	(A)	(µF)	r.p.m	m ³ /h	dB(A)	Ins.cl.	IP
BTFM 400-T/6-20/EX	380	50	0,37	1,2	-	1390	3500	60	F	55
BTFM 450-T/6-20/EX	380	50	0,55	1,6	-	1365	4500	62	F	55
BTFM 500-T/6-20/EX	380	50	0,55	1,6	-	1365	7000	66	F	55
BTFM 560-T/6-18/EX	380	50	0,75	2,1	-	1405	10000	63	F	55
BTFM 630-T/6-16/EX	380	50	1,1	2,6	-	1410	14000	70	F	55
BTFM 710-T/6-14/EX	380	50	1,5	3,5	-	1410	17500	71	F	55
BTFM 800-T/6-10/EX	380	50	2,2	5,0	-	1425	23000	74	F	55
BTFM 800-T/6-14/EX	380	50	3	6,6	-	1425	25000	76	F	55
BTFM 900-T/6-12/EX	380	50	4	8,4	-	1440	35000	79	F	55
BTFM 900-T/6-16/EX	380	50	5,5	11,2	-	1465	40000	81	F	55
BTFM 1000-T/6-14/EX	380	50	7,5	15,4	-	1465	50000	84	F	55
BTFM 1000-T/6-20/EX	380	50	11	21,3	-	1465	60000	86	F	55
BTFM 1000-T/6-24/EX	380	50	15	29,4	-	1465	70000	87	F	55
BTFM 1000-T/6-28/EX	380	50	18,5	34,5	-	1470	80000	88	F	55
BTFM 1250-T/6-14/EX	380	50	22	42,5	-	1470	100000	94	F	55
BTFM 1250-T/6-20/EX	380	50	30	55,0	-	1470	115000	94	F	55

Sound Level Measured from 3m distance in room condition.

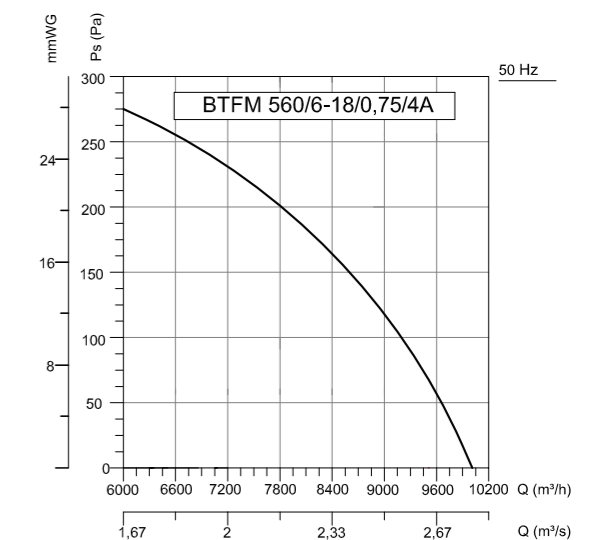
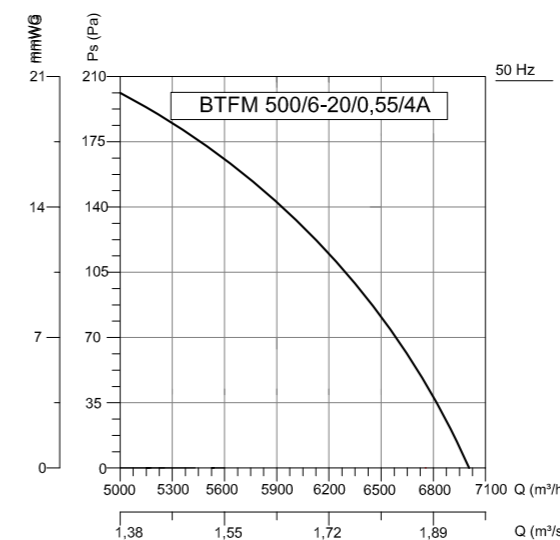
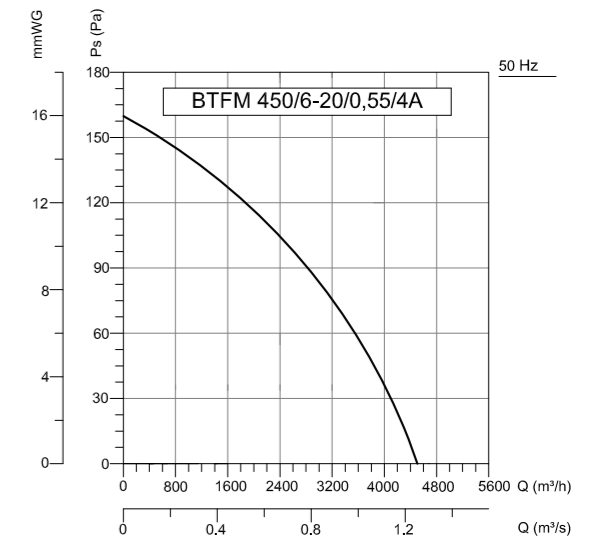
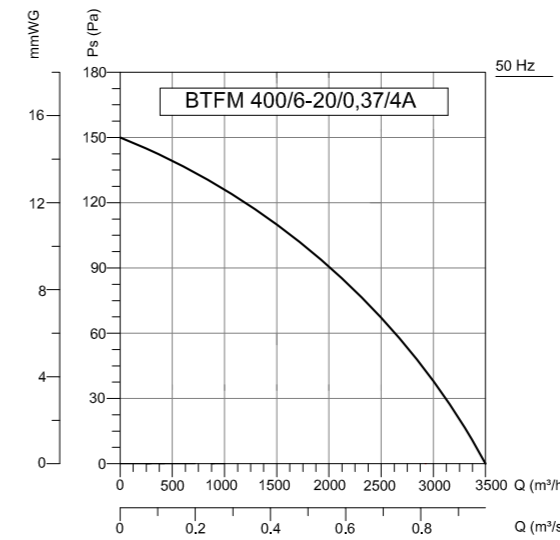

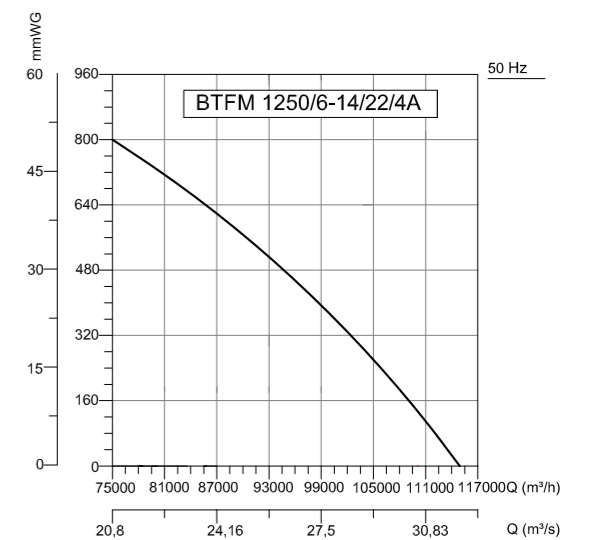
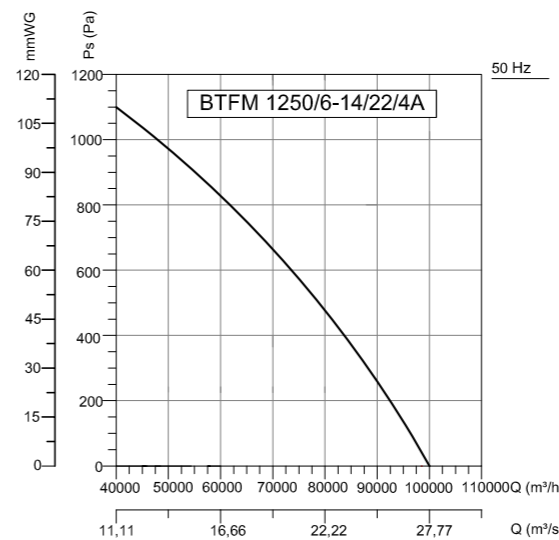
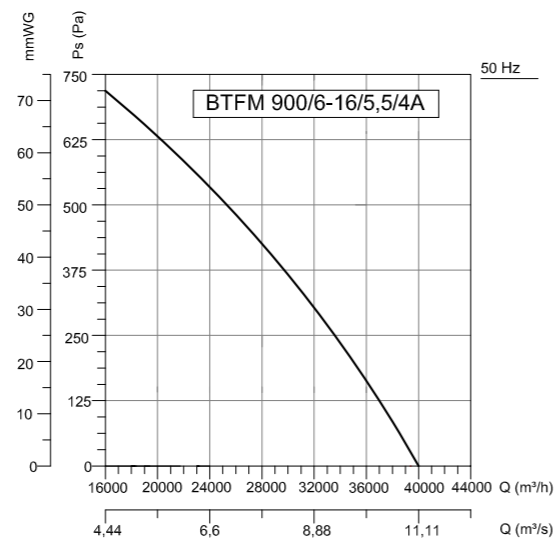
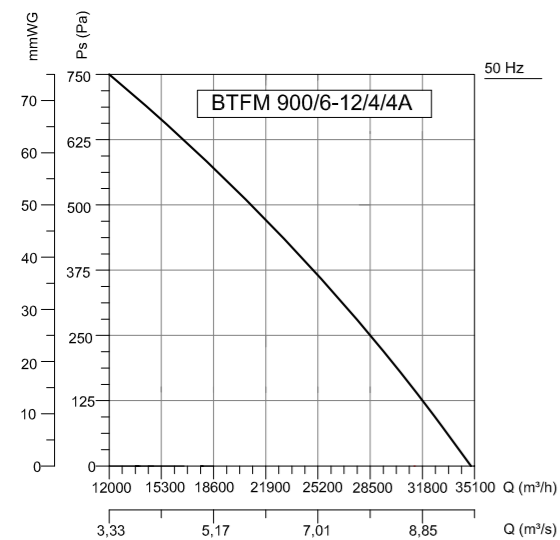
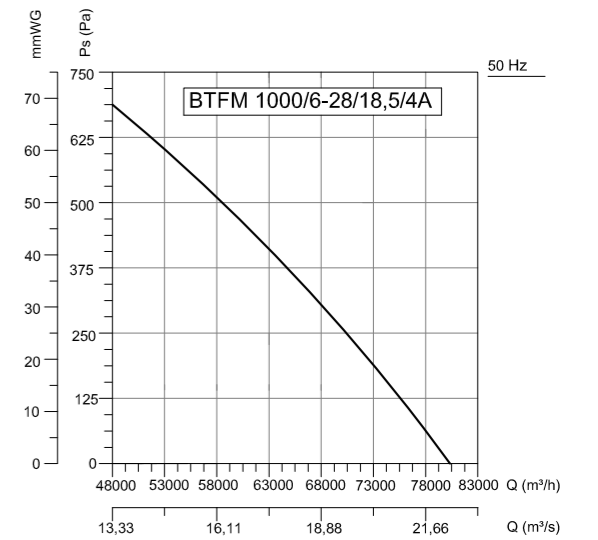
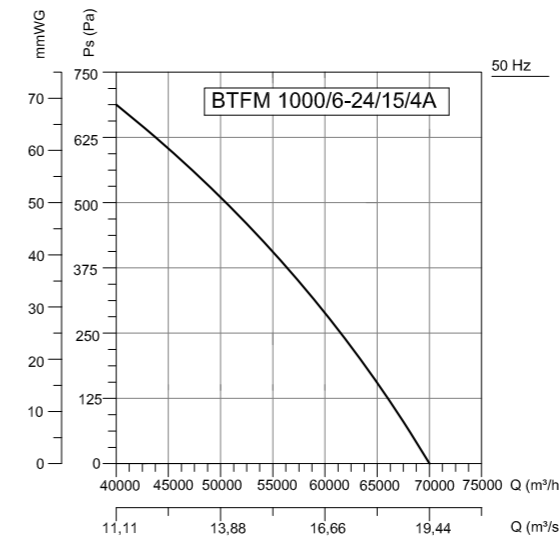
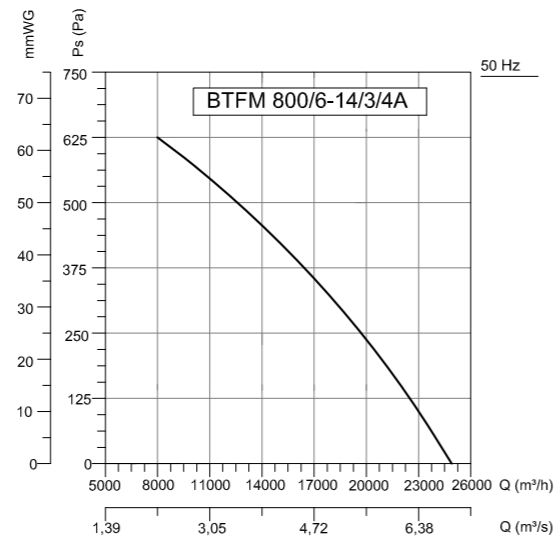
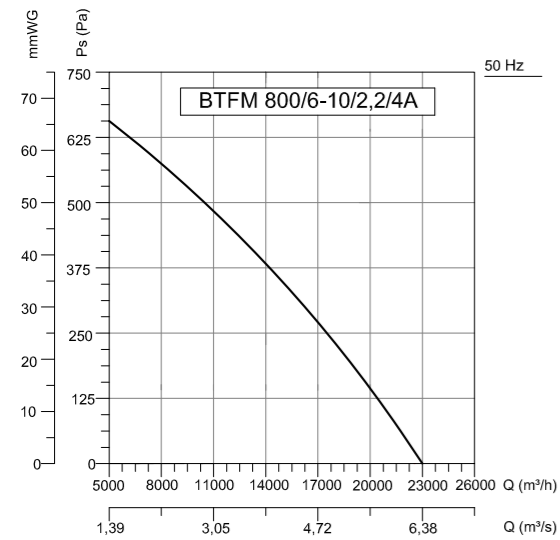
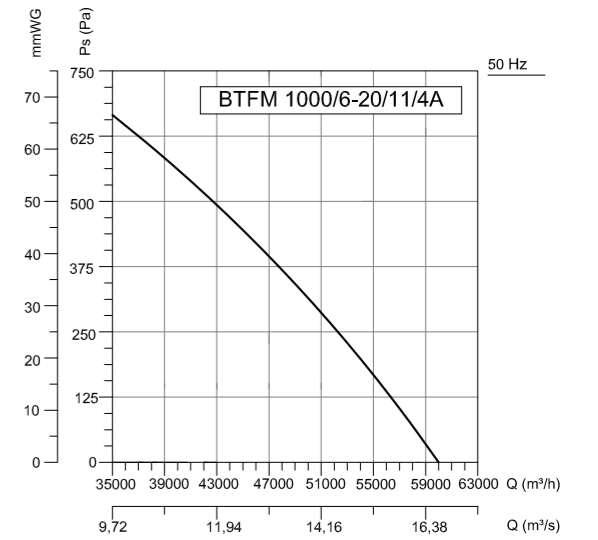
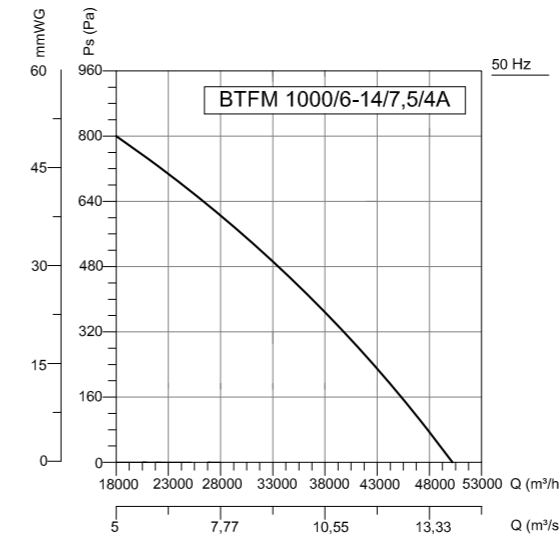
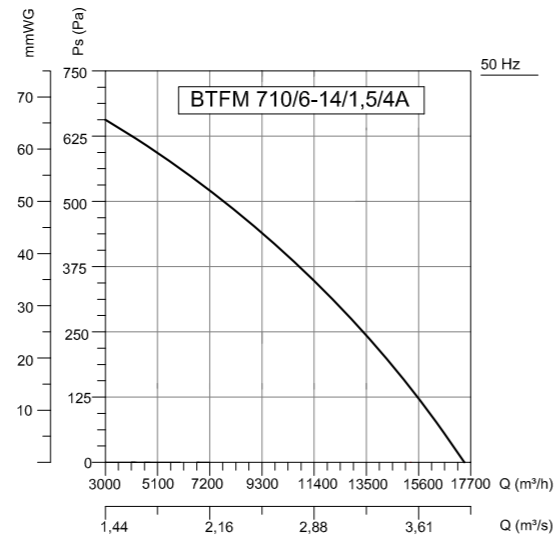
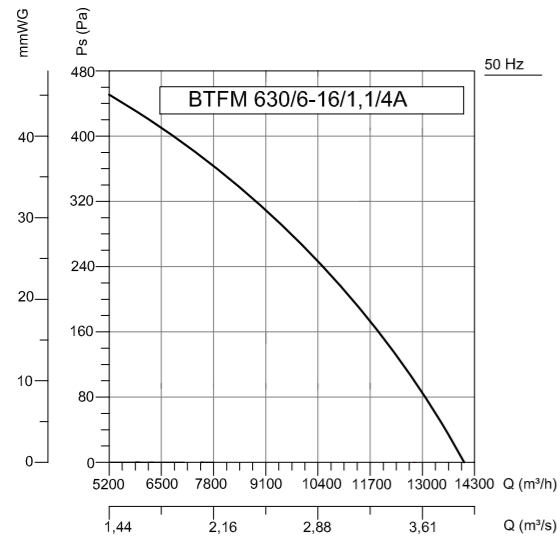

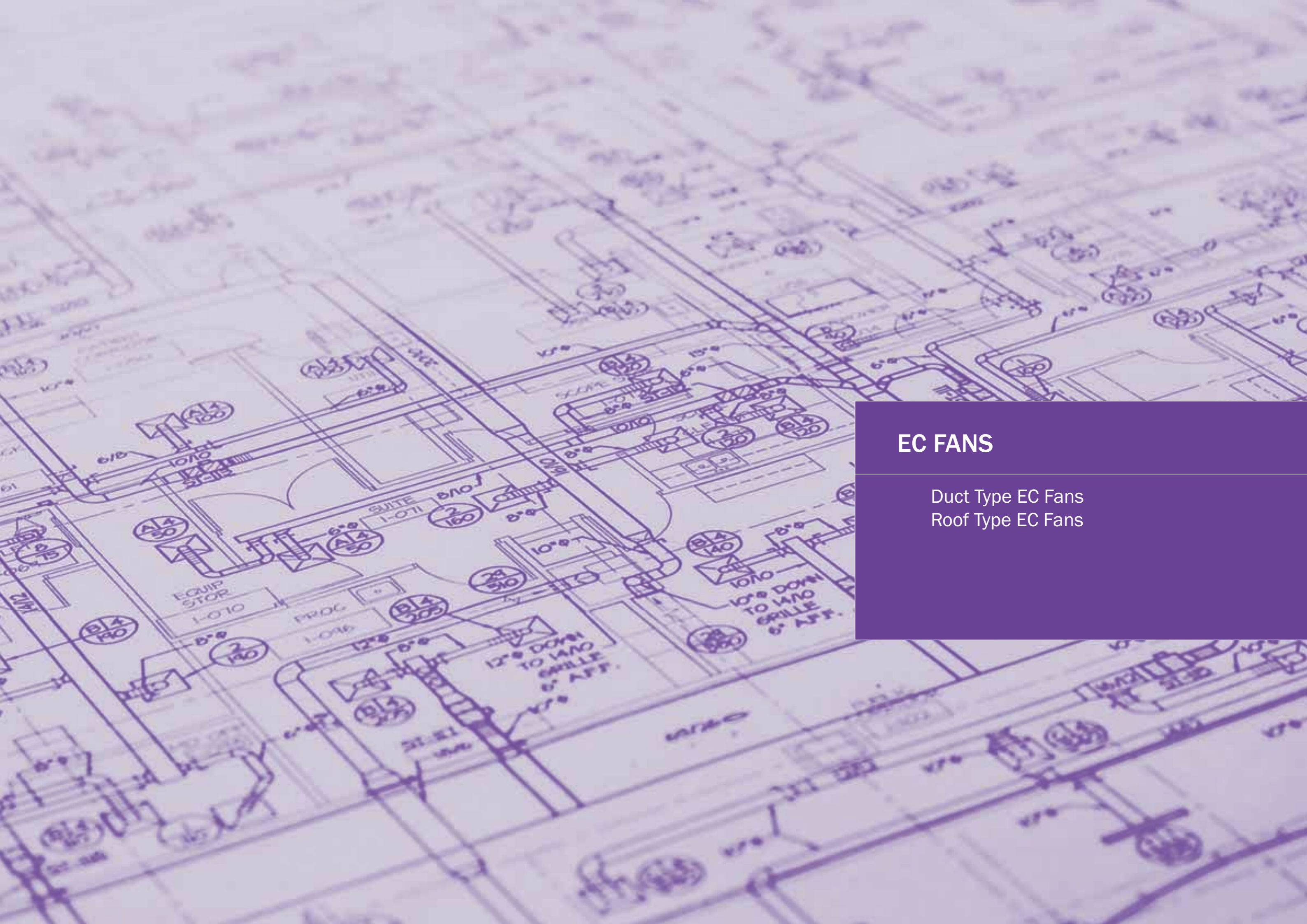

EC FANS

Duct Type EC Fans
Roof Type EC Fans



EC FANS

Productive and Nature Friendly

BVN EC series are electronic commutated external rotor motor which is integrated with electronic card. BVN Fans with high efficiency and low energy cost are manufactured in according to ERP (2009/125/EC- eco-design). EC motor technology has more than %90 efficiency values and more efficient than conventional motors.

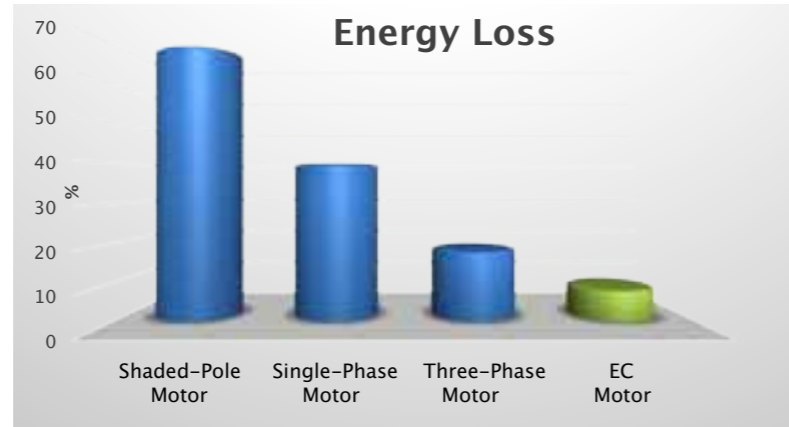

Low energy cost is important for both environment and customer EC motor technology does not provide only efficiency but also provides control, transmission and visualization function with its electronic card. Through sensors, EC Fans incorporate pressure, air quality, temperature and etc. parameters into automation.





BDTX-EC

ROUND DUCT TYPE FANS / Backward Curved

Device Components and Material Properties

The case and fan are made of high quality galvanized sheet metal which is pressed against corrosion. All models are equipped with EC motor with integrated speed control. The terminal box and mounting legs are supplied with the product as standard. Suction and discharge nozzles are compatible with duct diameters and can be connected by clamp.

Fan Structure

Designed to work between round channels. The fan blades are aerodynamically curved and provide regular flow. The fans are composed of backward sloping and infrequently arranged fins.

Benefits

The rotation of the fan on the motor housing saves efficiency and space. It works at optimum sound levels while providing strong air suction. It can be operated in any position. If necessary, it can be mounted on the wall thanks to the mounting legs. With a more efficient motor, system efficiency is increased and lower operating costs are ensured.

Speed Control

With EC motor integrated speed control, the desired speed can be achieved.

Usage Areas

Round duct fans are used in low and medium volume ventilation requirements in duct systems where the application area is limited. It should be used with oil holding filter in oily environments.

Technical Drawing and Tables

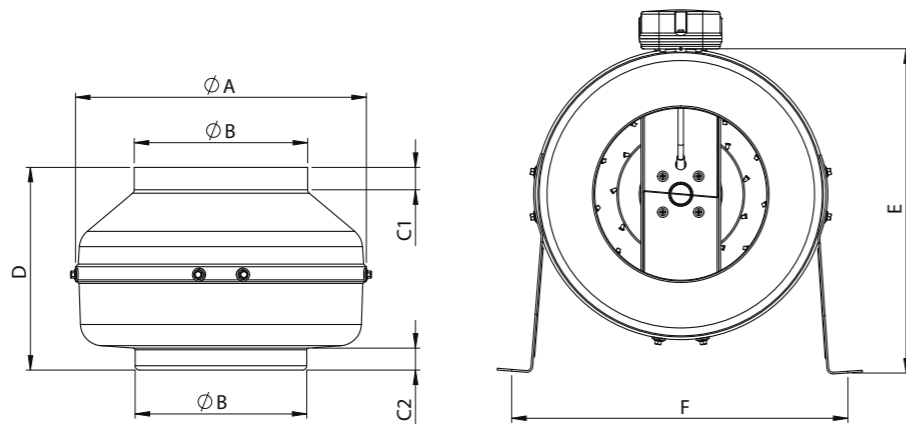

TYPE	A	B	C1	C2	D	E	F
BDTX-EC 100	245	97	20	20	197	273	268
BDTX-EC 125	245	122	20	20	188	273	268
BDTX-EC 150	272	147	23	25	192	286	295
BDTX-EC 160	272	157	23	25	192	286	295
BDTX-EC 200	330	196	30	28	230	380	352
BDTX-EC 250	330	247	30	28	227	380	352
BDTX-EC 315	400	313	30	30	285	415	422
BDTX-EC 355	400	352	30	30	378	415	422

Dimensions are in (mm)

TYPE	VOLTAGE	FREQUENCY	POWER	CURRENT	SPEED	AIR FLOW	MAX. PRESSURE	SOUND
	V	Hz	W	(A)	r.p.m	m ³ /h	Pa	dB(A)
BDTX-EC 100	220	50/60	90	0,7	3500	350	750	44
BDTX-EC 125	220	50/60	92	0,71	3450	500	690	43
BDTX-EC 150	220	50/60	94	0,72	3350	600	630	46
BDTX-EC 160	220	50/60	96	0,73	3345	650	650	45
BDTX-EC 200	220	50/60	130	0,87	3000	1100	600	46
BDTX-EC 250	220	50/60	135	0,85	3000	1300	700	46
BDTX-EC 315	220	50/60	150	1,2	2500	1700	750	48
BDTX-EC 355	220	50/60	350	1,5	2000	2200	500	45

Sound Level Measured from 3m distance in room condition.

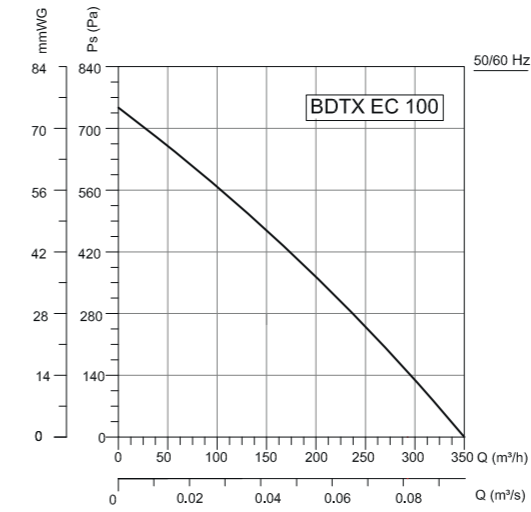

Frequency	Tot	63	125	250	500	1000	2000	4000	8000	Hz
L _{wa} Inlet	71	53	65	62	65	64	60	52	42	dB(A)
L _{wa} Outlet	68	54	64	58	62	61	58	50	40	dB(A)
L _{wa} Surrounding	51	29	17	30	47	46	45	39	27	dB(A)

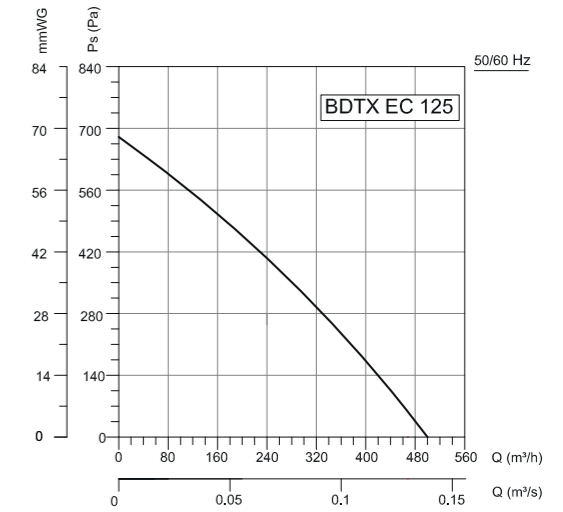

Frequency	Tot	63	125	250	500	1000	2000	4000	8000	Hz
L _{wa} Inlet	70	47	63	64	65	63	60	55	45	dB(A)
L _{wa} Outlet	68	49	62	59	62	61	58	52	43	dB(A)
L _{wa} Surrounding	50	20	20	39	45	44	43	36	30	dB(A)

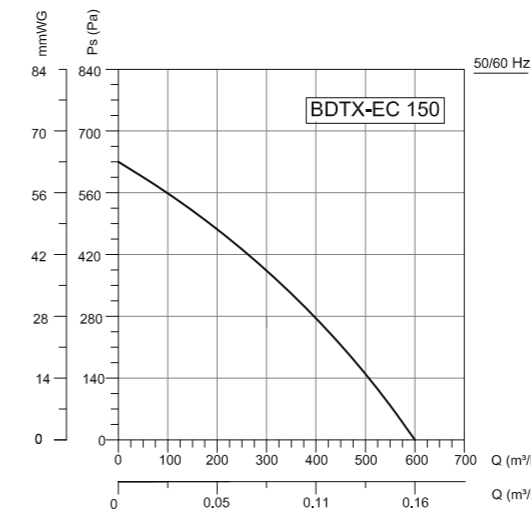

Frequency	Tot	63	125	250	500	1000	2000	4000	8000	Hz
L _{wa} Inlet	76	52	73	65	69	67	62	60	50	dB(A)
L _{wa} Outlet	74	55	71	62	68	64	62	55	50	dB(A)
L _{wa} Surrounding	53	20	35	37	50	45	46	44	32	dB(A)

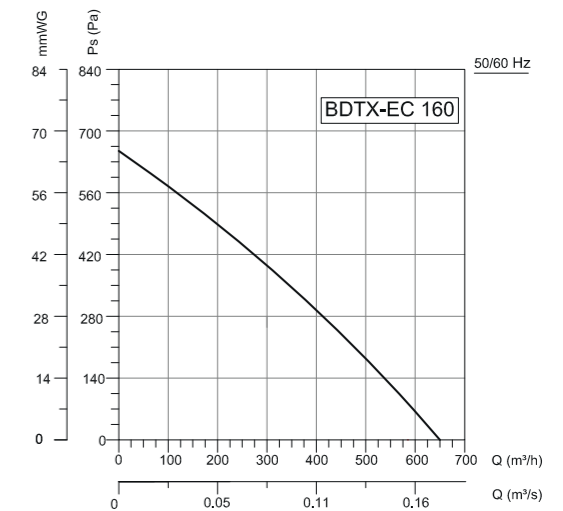

Frequency	Tot	63	125	250	500	1000	2000	4000	8000	Hz
L _{wa} Inlet	75	50	70	66	71	68	45	58	48	dB(A)
L _{wa} Outlet	76	56	74	61	69	66	62	56	48	dB(A)
L _{wa} Surrounding	52	10	32	36	48	46	45	42	28	dB(A)

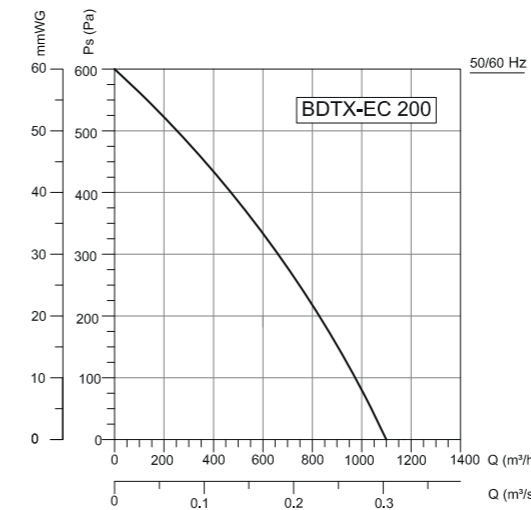

Frequency	Tot	63	125	250	500	1000	2000	4000	8000	Hz
L _{wa} Inlet	70	42	61	64	63	64	63	56	54	dB(A)
L _{wa} Outlet	71	49	59	62	65	64	64	58	53	dB(A)
L _{wa} Surrounding	53	8	25	32	45	49	47	42	38	dB(A)

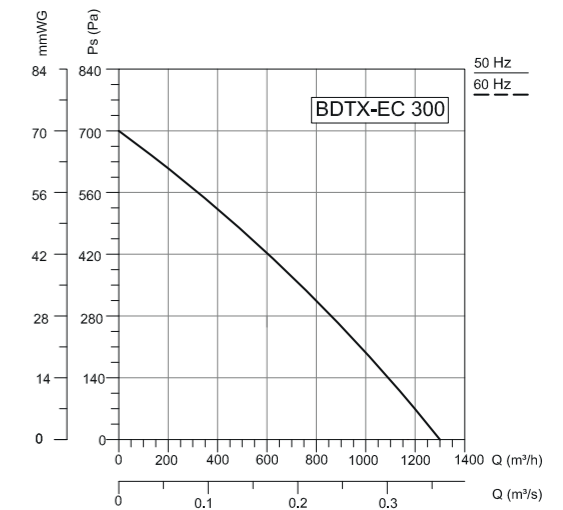

Frequency	Tot	63	125	250	500	1000	2000	4000	8000	Hz
L _{wa} Inlet	71	42	61	64	64	64	63	56	54	dB(A)
L _{wa} Outlet	72	49	60	63	66	64	66	58	53	dB(A)
L _{wa} Surrounding	54	8	35	40	47	50	47	45	40	dB(A)

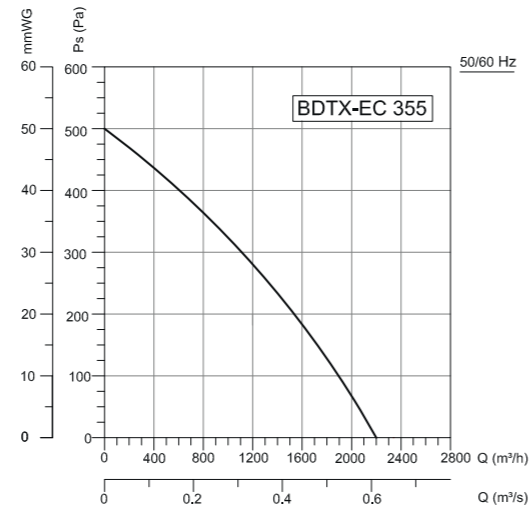
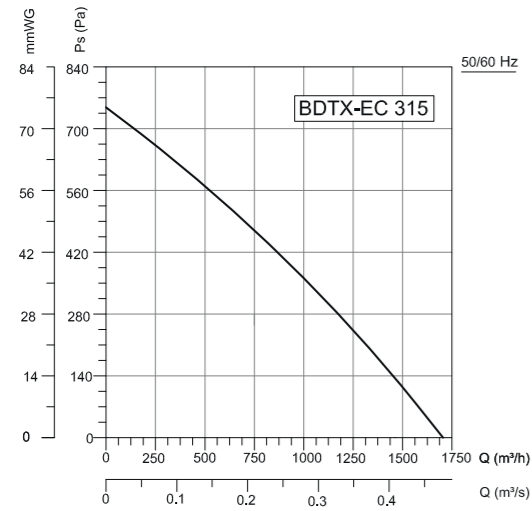

Frequency	Tot	63	125	250	500	1000	2000	4000	8000	Hz
L _{wa} Inlet	70	49	59	65	61	64	61	60	50	dB(A)
L _{wa} Outlet	71	48	60	65	61	65	63	61	51	dB(A)
L _{wa} Surrounding	52	27	28	46	45	47	45	42	30	dB(A)

Frequency	Tot	63	125	250	500	1000	2000	4000	8000	Hz
L _{wa} Inlet	70	49	59	65	62	65	61	60	50	dB(A)
L _{wa} Outlet	71	48	60	65	61	65	63	61	51	dB(A)
L _{wa} Surrounding	54	28	29	47	47	49	45	43	30	dB(A)

Accessories



BDKF-EC

RECTANGULAR DUCT FANS / Backward Curved



Fan Components and Material Properties

Rectangular body is manufactured from galvanized steel sheet. The models of Bdkf 30-15 / 70-40A are made of high quality galvanized steel which is resistant to corrosion. Bdkf 70-40B / 80-50 / 100-50 models are made of aluminum sheet. All models are equipped with EC motor with integrated speed control.

Fan Structure

It is designed to work between the rectangular channel. The fan blades are aerodynamically curved and provide regular flow. The fans are composed of backward sloping and infrequently arranged fins.

Benefits

The swing-out lid allows the product to be maintained effortlessly without removing the fan. Thanks to the aerodynamic wing structure, they work quietly. With a more efficient motor, system efficiency is increased and lower operating costs are ensured.

Speed Control

With EC motor integrated speed control, the desired speed can be achieved.

Usage Areas

It is designed to meet medium and high volume ventilation requirements in rectangular duct systems where the application area is limited.

Technical Drawing and Tables

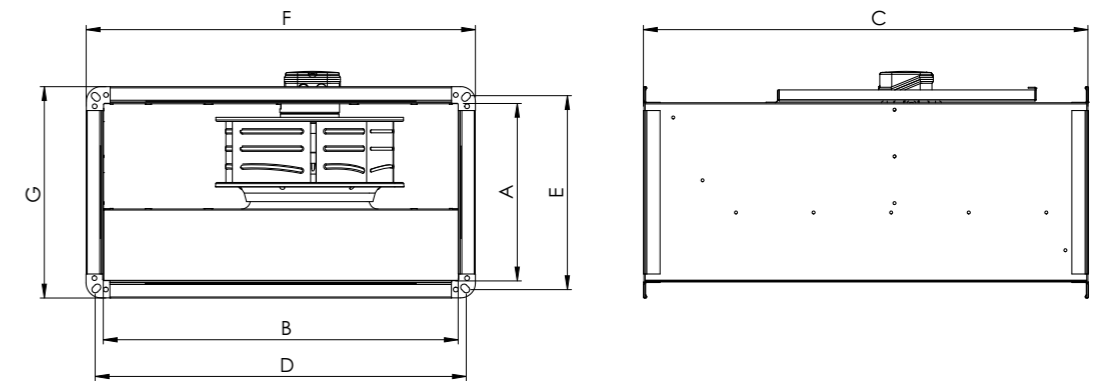

TYPE	A	B	C	D	E	F	G
BDKF-EC 30-15	150	300	400	320	170	350	200
BDKF-EC 40-20	200	400	500	420	220	450	250
BDKF-EC 50-25	250	500	565	520	270	550	300
BDKF-EC 60-30	300	600	750	620	320	650	350
BDKF-EC 60-35	350	600	750	620	370	650	400
BDKF-EC 70-40	400	700	800	720	420	750	450
BDKF-EC 80-50	500	800	920	820	520	850	560
BDKF-EC 100-50	500	1000	1050	1030	530	1060	560

Dimensions are in (mm)

TYPE	VOLTAGE	FREQUENCY	POWER	CURRENT	SPEED	AIR FLOW	MAX. PRESSURE	SOUND PRESSURE
	V	Hz	W	(A)	r.p.m	m ³ /h	Pa	dB(A)
BDKF-EC 30-15	220	50/60	98	0,74	3200	650	750	43
BDKF-EC 40-20	220	50/60	150	0,98	2945	1300	750	48
BDKF-EC 50-25	220	50/60	140	1,1	2400	1600	750	58
BDKF-EC 60-30	220	50/60	355	1,56	2050	2150	550	50
BDKF-EC 60-35	220	50/60	400	2,2	1900	3550	850	53
BDKF-EC 70-40	380	50/60	1000	1,5	1500	6500	650	56
BDKF-EC 80-50	380	50/60	870	1,46	1100	7000	450	64
BDKF-EC 100-50	380	50/60	770	1,3	850	8500	320	66

Sound Level Measured from 3m distance in room condition.

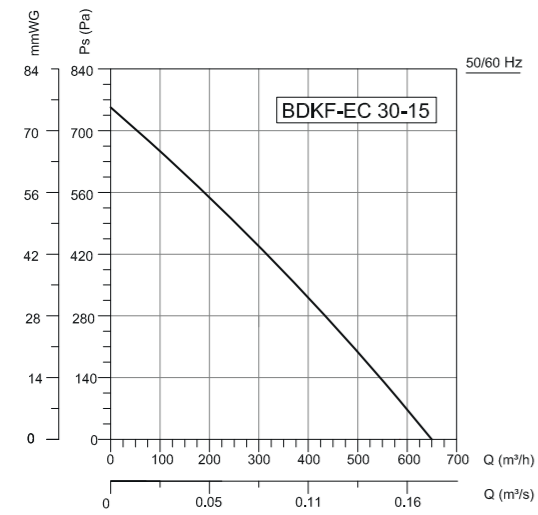

Frequency	Tot	63	125	250	500	1000	2000	4000	8000	Hz
L _{WA} Inlet	66	44	56	64	56	55	53	47	38	dB(A)
L _{WA} Outlet	69	48	53	66	63	61	58	51	43	dB(A)
L _{WA} Surrounding	50	26	33	47	44	42	41	35	27	dB(A)

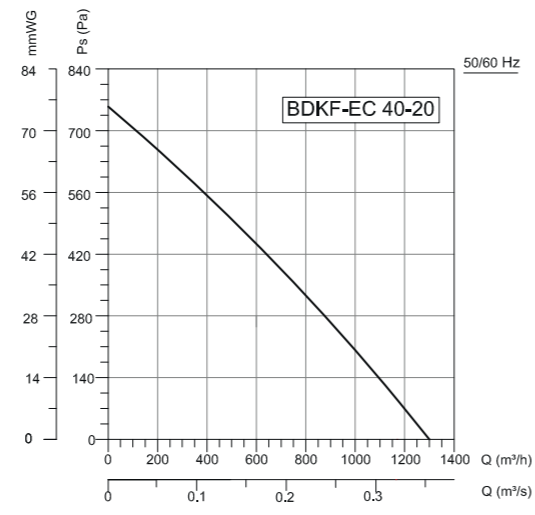

Frequency	Tot	63	125	250	500	1000	2000	4000	8000	Hz
L _{WA} Inlet	69	44	54	66	58	61	59	55	47	dB(A)
L _{WA} Outlet	72	44	53	67	64	63	66	61	58	dB(A)
L _{WA} Surrounding	55	20	34	53	45	44	44	38	35	dB(A)

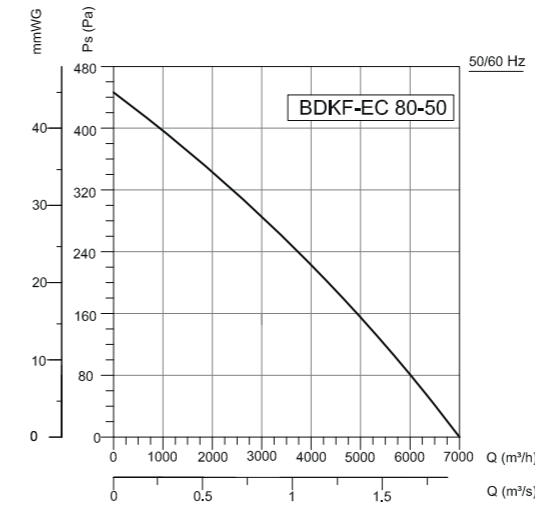

Frequency	Tot	63	125	250	500	1000	2000	4000	8000	Hz
L _{WA} Inlet	79	61	72	71	73	71	71	66	58	dB(A)
L _{WA} Outlet	84	66	75	76	77	79	75	70	61	dB(A)
L _{WA} Surrounding	71	45	68	64	61	61	60	54	43	dB(A)

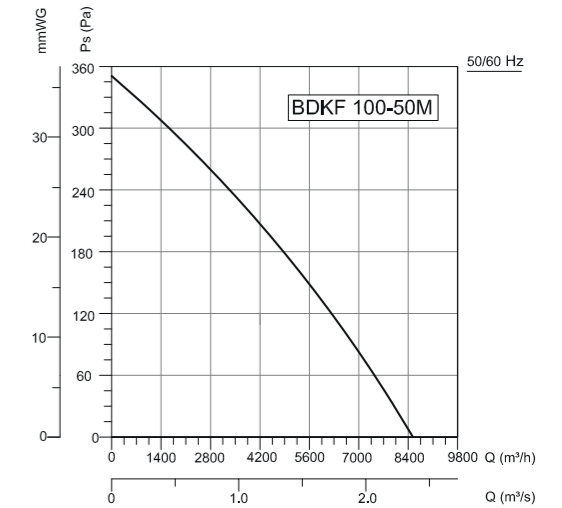

Frequency	Tot	63	125	250	500	1000	2000	4000	8000	Hz
L _{WA} Inlet	84	70	77	76	78	78	75	71	65	dB(A)
L _{WA} Outlet	89	71	80	81	82	83	80	74	65	dB(A)
L _{WA} Surrounding	72	58	69	64	62	60	56	52	50	dB(A)

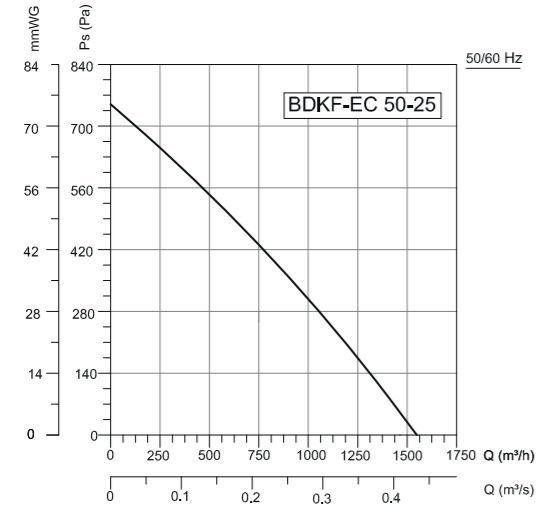

Frequency	Tot	63	125	250	500	1000	2000	4000	8000	Hz
L _{WA} Inlet	74	50	61	67	65	68	66	63	60	dB(A)
L _{WA} Outlet	78	51	61	69	71	71	73	67	70	dB(A)
L _{WA} Surrounding	65	33	40	59	57	59	58	50	47	dB(A)

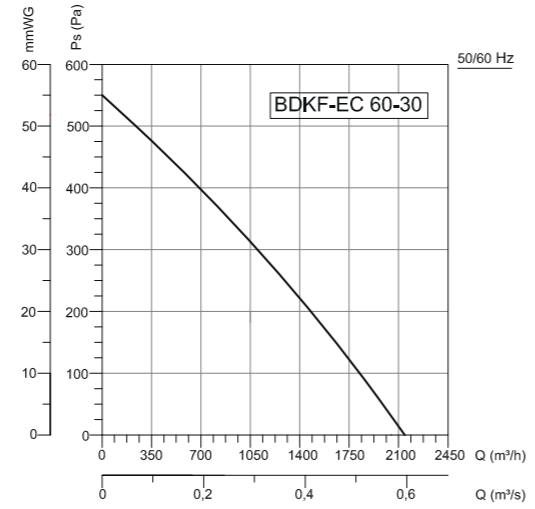

Frequency	Tot	63	125	250	500	1000	2000	4000	8000	Hz
L _{WA} Inlet	69	50	62	64	61	62	57	52	44	dB(A)
L _{WA} Outlet	72	49	60	65	68	65	63	58	46	dB(A)
L _{WA} Surrounding	57	35	47	54	52	47	44	39	32	dB(A)

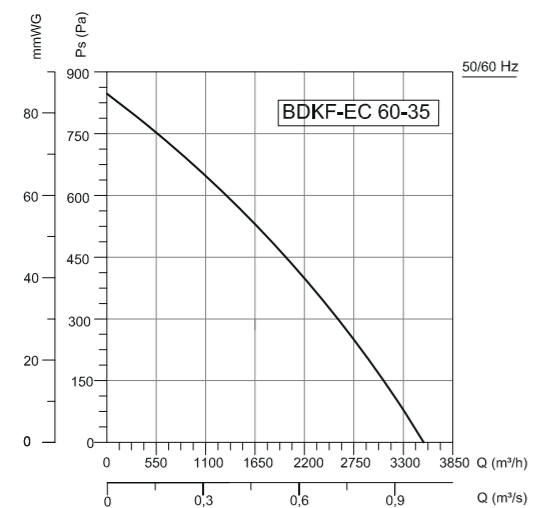

Frequency	Tot	63	125	250	500	1000	2000	4000	8000	Hz
L _{WA} Inlet	70	50	65	61	63	60	61	56	48	dB(A)
L _{WA} Outlet	76	54	72	68	69	68	67	62	54	dB(A)
L _{WA} Surrounding	60	27	57	53	50	49	48	49	37	dB(A)

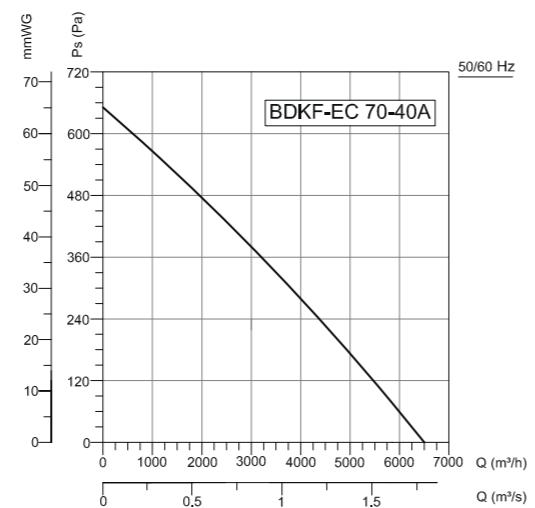

Frequency	Tot	63	125	250	500	1000	2000	4000	8000	Hz
L _{WA} Inlet	75	60	70	68	69	66	66	62	52	dB(A)
L _{WA} Outlet	79	60	71	71	73	74	71	38	55	dB(A)
L _{WA} Surrounding	65	41	62	58	56	56	49	42	36	dB(A)

Accessories





BRF-V EC

VERTICAL OUTLET ROOF FANS

Fan Components and Material Properties

The BRF-V EC series of vertical-centric roof radial fans are made of galvanized sheet steel. The fan wheels of the BRF 450-500-560 models are made of aluminum sheet. All models are equipped with EC motor with integrated speed control.

Fan Structure

The fan blades are aerodynamically curved and provide regular flow. The fans are composed of backward sloping and infrequently arranged fins.

Benefits

BRF-V roof fans are particularly advantageous in vertical applications due to the fact that air cannot be absorbed horizontally. Thanks to the aerodynamic wing structure, they work quietly. Since the rainwater is easily evacuated, water ingress

is prevented from entering the chimney. With a more efficient motor, system efficiency is increased and lower operating costs are ensured.

Speed Control

With EC motor integrated speed control, the desired speed can be achieved.

Usage Areas

In order to increase the air quality of indoor spaces, it is used in situations where vertical shot is required under conditions where air cannot be disposed horizontally. The BRF-V roof fans operate at low volume with an external rotor motor. It is used on the roofs of the places where the air is to be refreshed and the chimneys on the bathroom and wc roofs of the buildings which are opened to the common shaft.

Technical Drawing and Tables

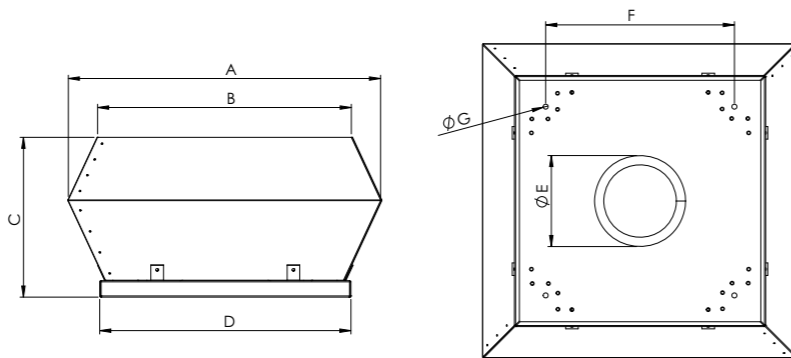
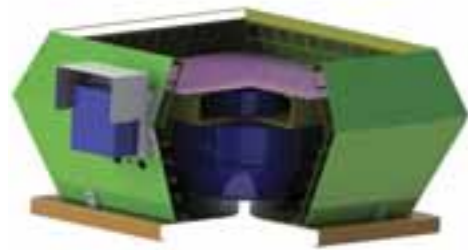

Accessories



TYPE	A	B	C	D	E	F	G
BRF-V EC 315	552	450	330	505	185	450	10
BRF-V EC 355	745	607	385	595	235	450	10
BRF-V EC 400	745	607	385	595	270	450	10
BRF-V EC 450	900	742	512	665	280	630	10
BRF-V EC 500	900	742	512	665	320	630	12
BRF-V EC 560	1190	955	595	946	360	740	12

Dimensions are in (mm)

TYPE	VOLTAGE	FREQUENCY	POWER	CURRENT	SPEED	AIR FLOW	MAX. PRESSURE	SOUND PRESSURE
	V	Hz	W	(A)	r.p.m	m ³ /h	Pa	dB(A)
BRF-V EC 315	220	50/60	350	1,5	2000	2200	500	45-37
BRF-V EC 355	220	50/60	400	2,1	1850	3500	620	46-38
BRF-V EC 400	220	50/60	420	2,3	1450	4000	600	47-39
BRF-V EC 450	380	50/60	1000	1,5	1450	6500	650	50-42
BRF-V EC 500	380	50/60	870	1,46	1100	7000	450	52-44
BRF-V EC 560	380	50/60	770	1,3	850	8500	320	60-52

Sound Level Measured from 3m distance in room condition.

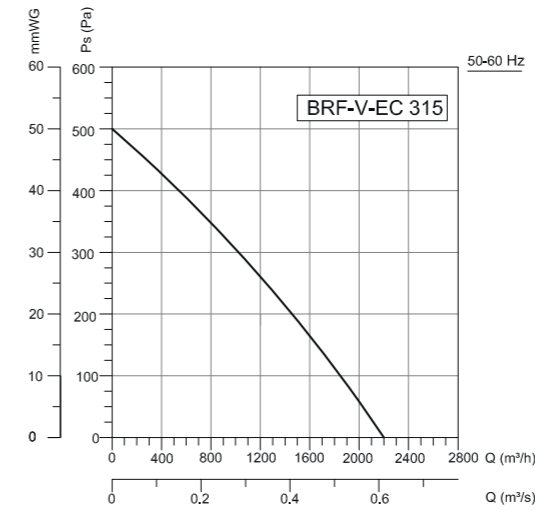

Frequency	Tot	63	125	250	500	1000	2000	4000	8000 Hz
L _{WA} Inlet	68	55	57	61	63	62	59	54	47 dB(A)
L _{WA} Surrounding	70	57	59	63	65	64	61	56	49 dB(A)

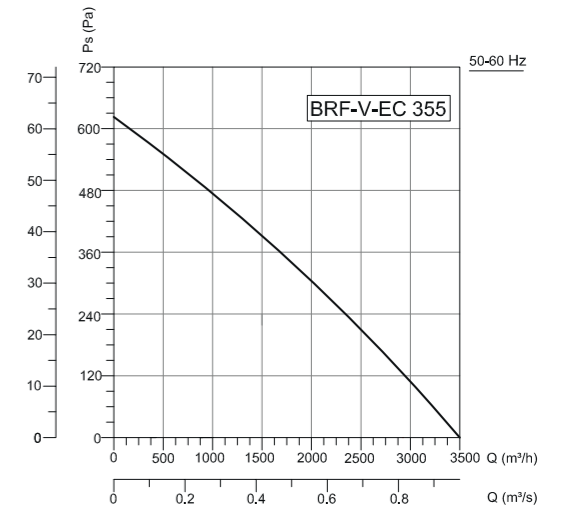

Frequency	Tot	63	125	250	500	1000	2000	4000	8000 Hz
L _{WA} Inlet	67	54	56	60	62	61	58	53	46 dB(A)
L _{WA} Surrounding	69	56	58	62	64	63	60	55	48 dB(A)

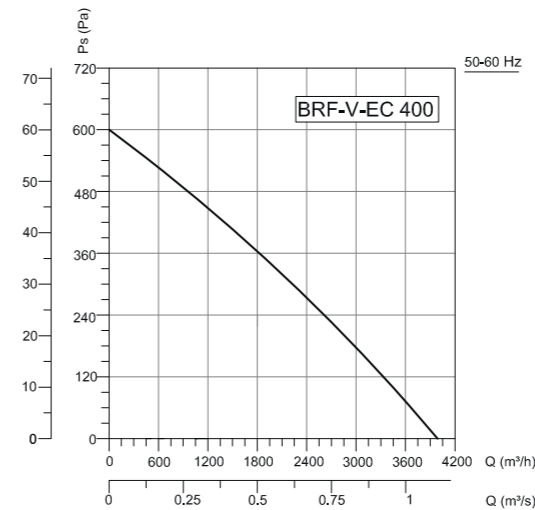

Frequency	Tot	63	125	250	500	1000	2000	4000	8000 Hz
L _{WA} Inlet	71	39	58	66	61	67	54	50	47 dB(A)
L _{WA} Surrounding	70	43	63	62	66	64	57	52	48 dB(A)

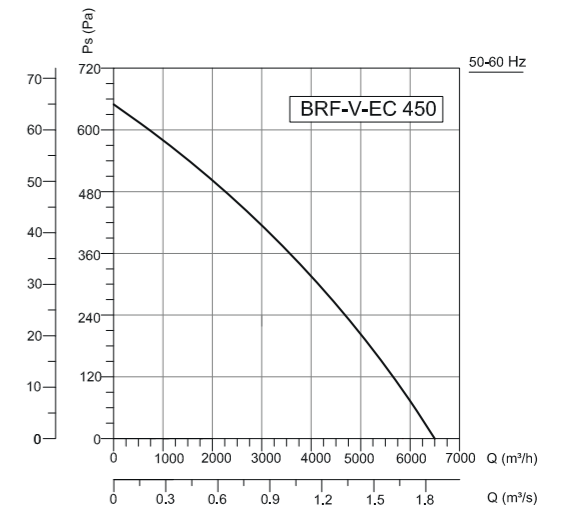

Frequency	Tot	63	125	250	500	1000	2000	4000	8000 Hz
L _{WA} Inlet	68	51	56	63	62	59	57	52	53 dB(A)
L _{WA} Surrounding	73	43	62	64	68	67	62	57	55 dB(A)

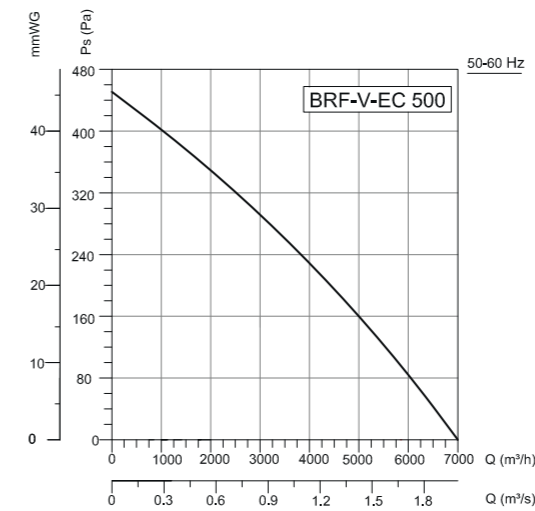

Frequency	Tot	63	125	250	500	1000	2000	4000	8000 Hz
L _{WA} Inlet	73	46	60	70	68	64	61	56	54 dB(A)
L _{WA} Surrounding	75	44	62	66	71	68	66	59	55 dB(A)

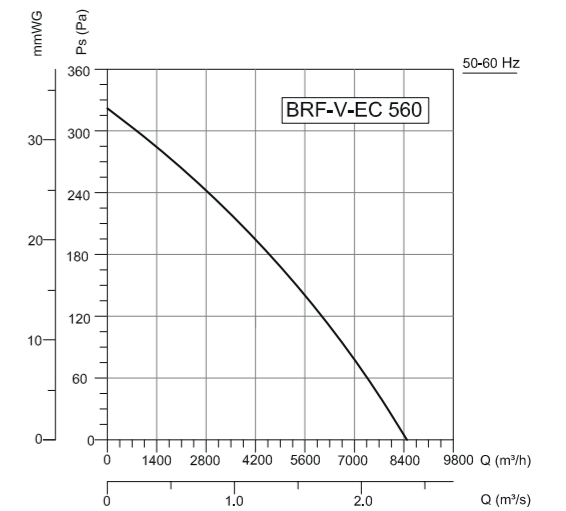

Frequency	Tot	63	125	250	500	1000	2000	4000	8000 Hz
L _{WA} Inlet	81	54	70	74	76	75	71	66	59 dB(A)
L _{WA} Surrounding	83	54	71	75	77	78	74	68	61 dB(A)

THERMO FANS

Thermo Fans transport air and smoke at high temperatures with their external motor design. With its comprehensive product models, they are used in applications such as kitchen ventilations, welding fumes, cooking ovens etc.

AREA OF USE

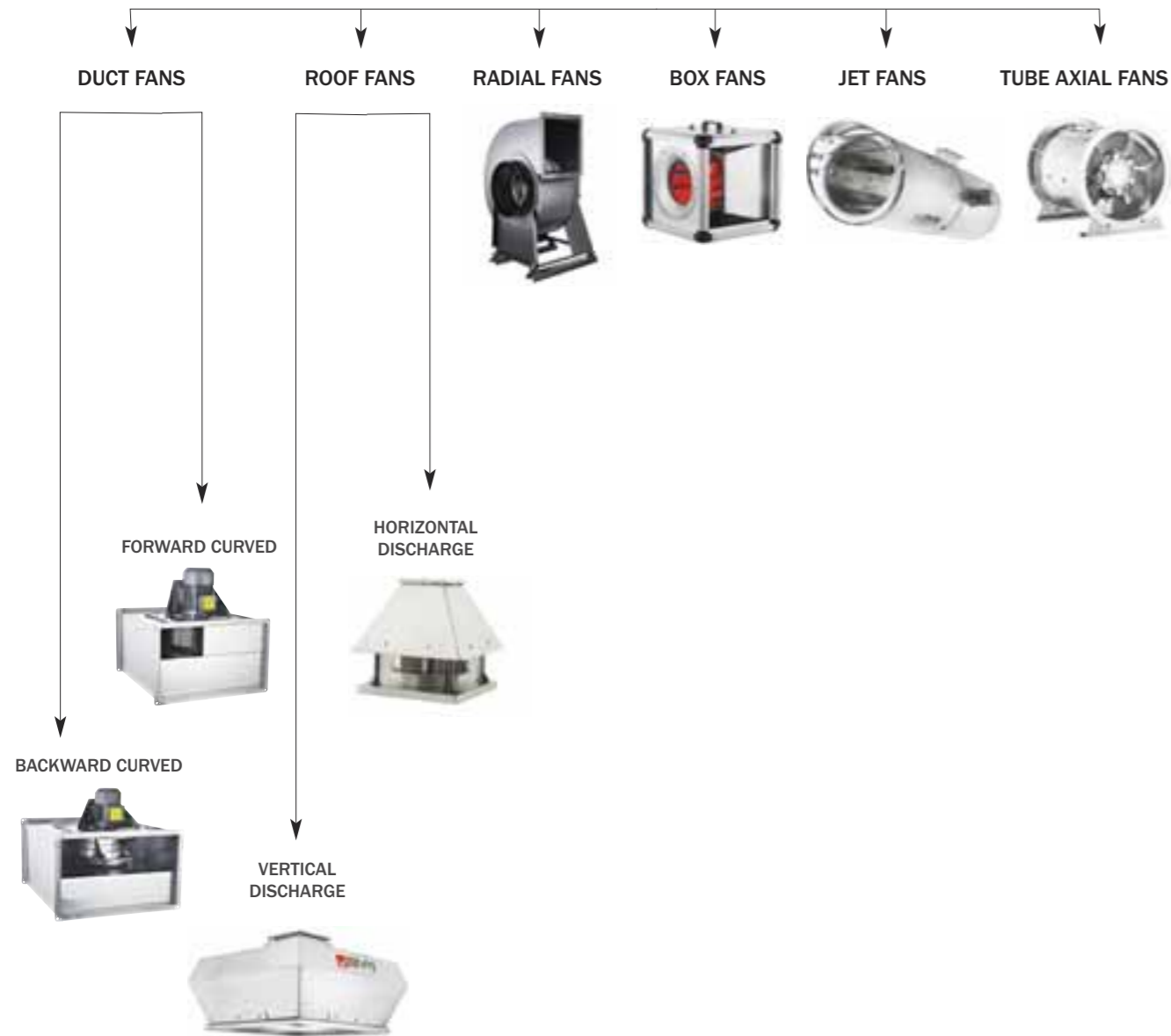



ARMO-JP

JET FANS / Axial

By providing jet flow in the outlet of the device, they are high temperature resistant fans which add toxic gases around the flow line to their own flow area and give momentum to the toxic gases and thus direct them to the exhaust points.

General Features

- EN 12101-3 and CE certificates.
- Motor and fan system are coupled to the muffler system.
- It can operate continuously for 2 hours at 400 C and 300 C.
- Products with diameters of 315, 355 and 400 mm.
- Special deflector design.
- Has an aesthetic appearance.

Rotor Features

- Fire resistant aluminum alloy casting blades and fan hub.
- Ability to work in single direction and double-gauge.
- In the case of reversible wing type, it is not subject to any loss of aerodynamic loss.
- The wings are aerofoil-shaped and have high aerodynamic performance in both unidirectional and bi-directional fins.
- The fan part of the fan is dynamically balanced according to ISO 1940 and there is no eccentricity during fan operation.
- Specially designed fan hub.



Body Features

Compact design with convenient and easy installation.

Motor Features

It has 2 and 4 pole motor options. Motors are in IP 55 class and Class - H insulation.

Fan Inlet Cone

Special design fan inlet cone for minimizing noise levels to a minimum by maximizing aerodynamic characteristics and performance.

Stator

It has a special design status to minimize sound levels by maximizing aerodynamic characteristics and performance.

Input Cone

It has a special design inlet cone for minimizing the sound levels by minimizing the aerodynamic characteristics and performance.



Technical Drawing and Tables

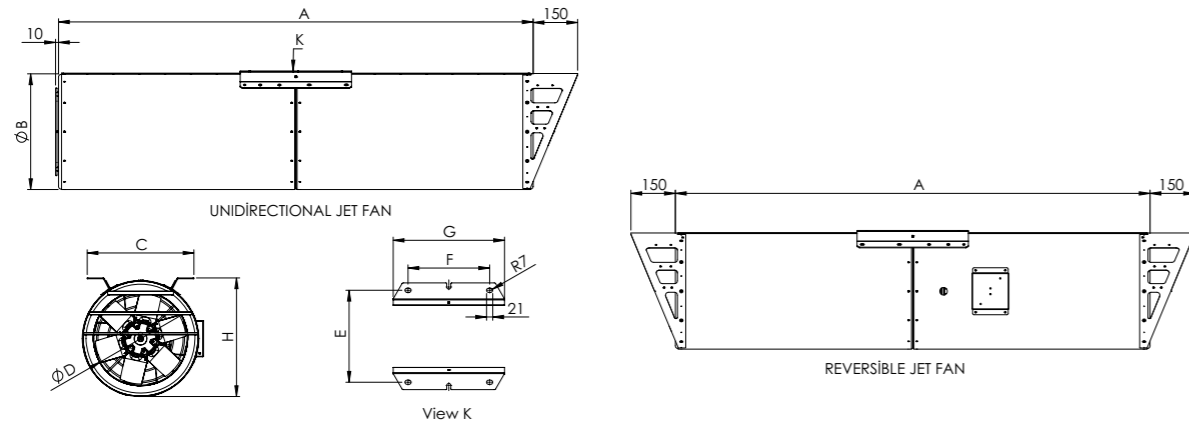

TYPE	A	B	C	D	E	F	G	H
ARMO-JP-315 UDA/RDA	1600	390	360	315	310	275	375	400
ARMO-JP-355 UDA/RDA	1700	455	410	355	360	275	375	465
ARMO-JP-400 UDA/RDA	1850	500	450	400	400	350	450	510

Dimensions are in (mm)

TYPE	VOLTAGE	FREQUENCY	POWER	CURRENT	THRUST	SPEED	AIR FLOW	SOUND PRESSURE	INSULATION CLASS	PROTECTION CLASS	WEIGHT
	V	Hz	kW	(A)	(N)	r.p.m	m ³ /h	dB(A)	Ins.cl.	IP	kg
ARMO-JP-315-UDA	400	50	0,8/0,2	1,91/0,6	25/6,3	2810/1390	4600/2300	66-49	H	55	91
ARMO-JP-355-UDA	400	50	1,1/0,25	2,2/0,55	45/11,3	2900/1435	6900/3450	70-52	H	55	98
ARMO-JP-400-UDA	400	50	1,5/0,37	3,4/0,8	75/18,7	2845/1420	10000/5000	72-53	H	55	105
ARMO-JP-315-RDA	400	50	0,8/0,2	1,91/0,6	24/6	2810/1390	4500/2250	62-45	H	55	93
ARMO-JP-355-RDA	400	50	1,1/0,25	2,2/0,55	41/10	2900/1435	6540/3270	66-48	H	55	100
ARMO-JP-400-RDA	400	50	1,5/0,37	3,4/0,8	70/17,5	2845/1420	9750/4875	68-49	H	55	107

Sound Level Measured from 3m distance in room condition.



ARMO-JR

JET FANS / Backward Curved

By providing jet flow in the outlet of the device, they are high temperature resistant fans which add toxic gases around the flow line to their own flow area and give momentum to the toxic gases and thus direct them to the exhaust points. Radial jet fans are used for the same purpose as axial jet fans. These fans have lower heights and are suitable for car parks with height less than 2.4m or with cassette access.

General Features

- EN 12101-3 and CE certificates.
- Motor and fan system are coupled to the muffler system.
- It can operate continuously for 2 hours at 400 C and 300 C.
- Special deflector design.
- Has an aesthetic appearance.

Rotor Features

- It is made of high quality galvanized steel with fire resistant.
- It has the capacity to shoot in one direction. Taking the air movement in the vertical direction; completes by shooting horizontally.



- The fan part of the fan is dynamically balanced according to ISO 1940 and there is no eccentricity during fan operation.
- Specially designed fan hub.

Body Features

Compact design with convenient and easy installation.

Motor Features

8, 4-pole double-speed motor. Motors are in IP 55 class and Class-H insulation.

Fan Inlet Cone

Special design fan inlet cone for minimizing noise levels to a minimum by maximizing aerodynamic characteristics and performance.

Input Cone

It has a special design inlet cone for minimizing the sound levels by minimizing the aerodynamic characteristics and performance.

Technical Drawing and Tables

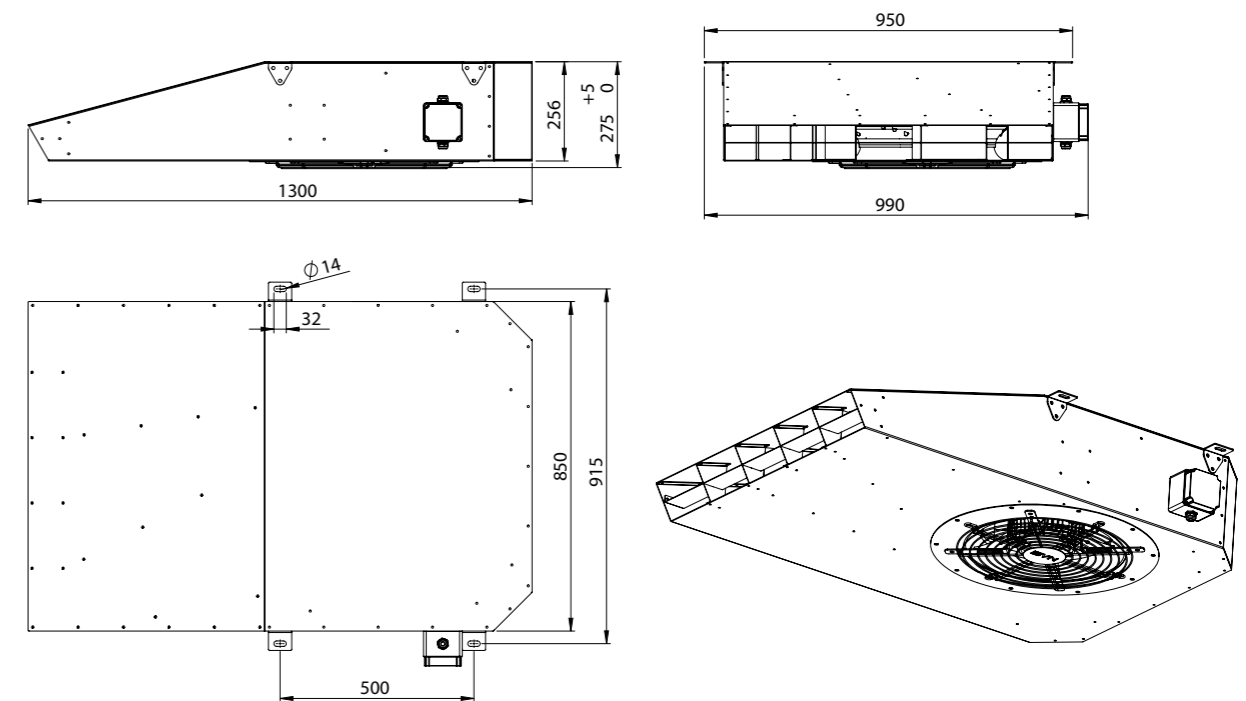

TYPE	THRUST	AIR FLOW	POWER	CURRENT	SPEED	WEIGHT
	(N)	m ³ /h	kW	(A)	d/d	kg
ARMO-JR 50	48/12	3375/6750	0,3/1,2	1,29/2,92	705/1430	80

Sound Level Measured from 3m distance in room condition.



ARMO-A

SMOKE AND HEAT EXHAUST FANS / Tube Axial



Axial tube fans are used in pressurization fan, fresh air fan and smoke exhaust fan applications. The fan sleeve is fire resistant and designed according to the noise standard. Smoke evacuation fans are fire resistant. Smoke discharge fans can be installed vertically and horizontally according to the characteristics of the structure.

General Features

- EN 12101-3 and CE certificates.
- 2 hours continuous operation at 400 C and 300 C
- There is a wide product range from 400 mm to 1250 mm.

Rotor Features

- Fire resistant aluminum alloy casting blades and fan hub.
- It is capable of one-way and two-way operation. The blades are specially designed according to each direction type.
- There is no aerodynamic loss in the case of reversible wing type operation.
- Wings are airfoil and provide high aerodynamic performance in both unidirectional and bidirectional vanes.
- Wing angles are adjustable. In this way, smoke discharge fans can be demanded at different flow rates and pressures.
- The fan part of the fan is balanced

dynamically to ISO 1940 and there is no eccentricity during the operation of the fan.

Body Features

- Fan body is steel sheet. Body is hot dip galvanized and corrosion resistant.
- It has short type body and long type body types.

Motor Features

- Offers 2.4 and 6-pole motors
- The motors are IP 55 class and Class-H insulated.
- All electric motor models are approved for continuous operation (S1) and Emergency operation (S2).

Ease of Maintenance

A maintenance cover is provided to ensure easy maintenance.

Usage Areas

They are the fans that provide the combustion of toxic gases that are supplied by the jet fans to the external environment. Axial fans are used in pressurization fan, fresh air fan and smoke exhaust fan applications.

Technical Drawing and Tables

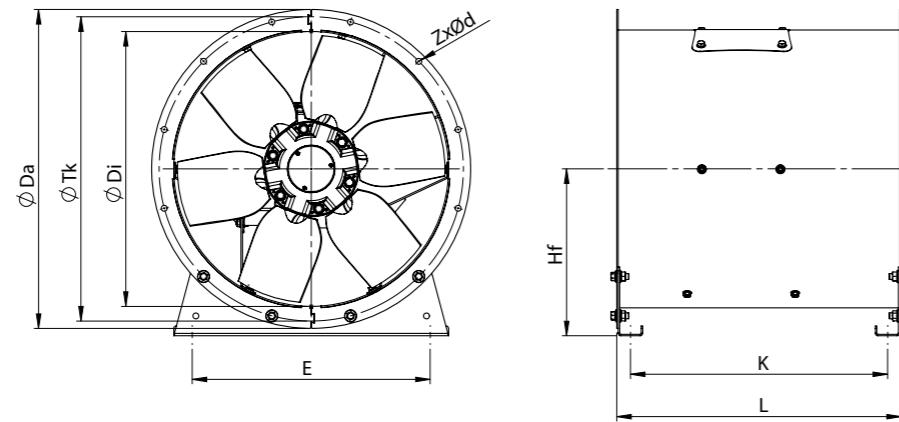

TYPE	ØDi	ØDa	ØTk	ZxØd	L	Hf	K	E
ARMO-A 400	400	480	450	8XØ12	474	255	420	335
ARMO-A 450	450	530	500	8XØ12	474	280	420	385
ARMO-A 500	500	590	560	12XØ12	580	310	524	425
ARMO-A 560	560	650	620	12XØ12	580	340	524	485
ARMO-A 630	630	720	690	12XØ12	600	375	544	555
ARMO-A 710	710	800	770	16XØ12	600	420	544	595
ARMO-A 800	800	890	860	16XØ12	700	470	634	625
ARMO-A 900	900	1005	970	16XØ15	775	527	697	675
ARMO-A 1000	1000	1105	1070	16XØ15	850	577	772	775
ARMO-A 1250	1250	1390	1320	20XØ15	949	720	861	950

Dimensions are in (mm)

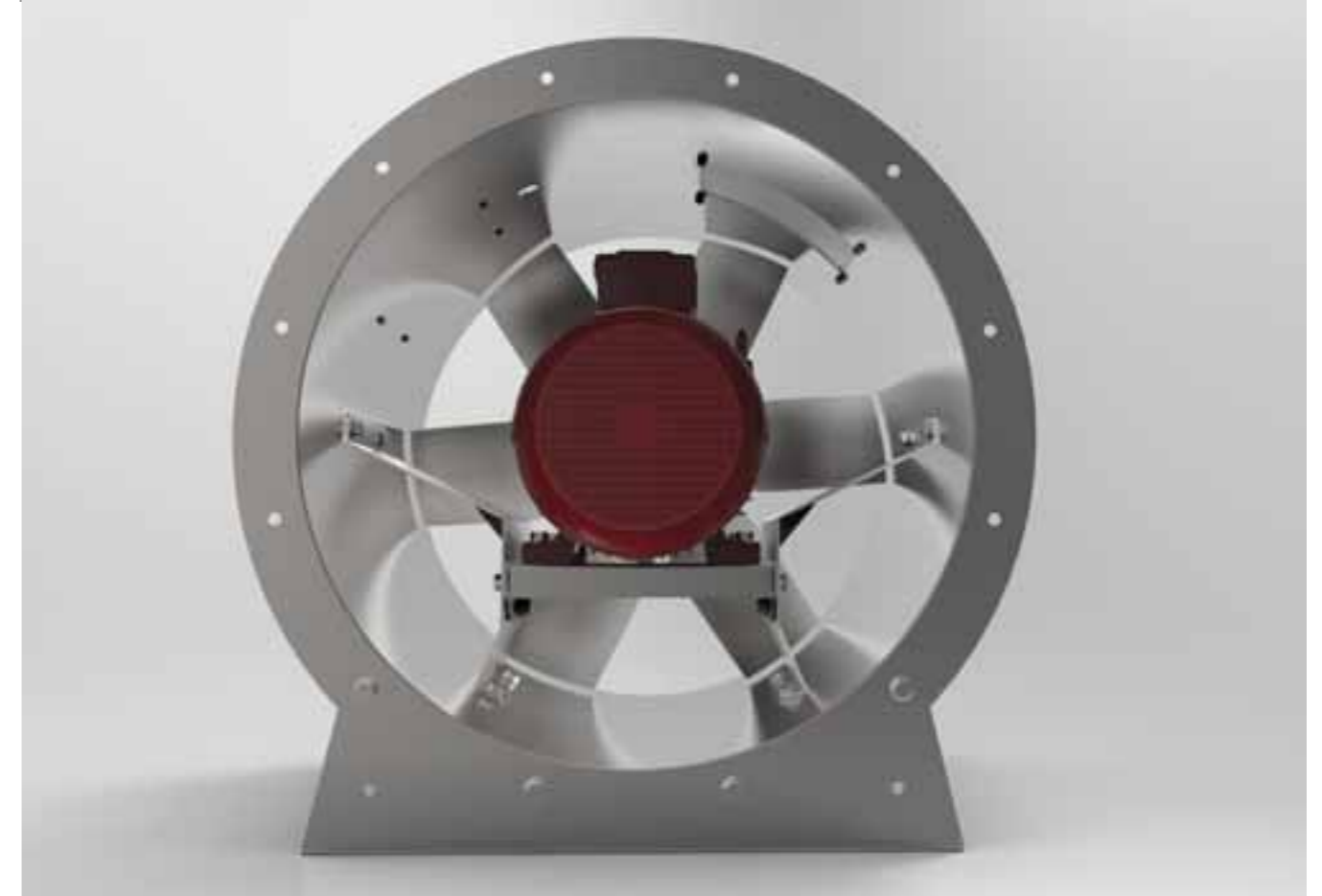

TYPE	2 POLE		DIAMETER mm	POWER kW	CURRENT 230V - 400V	AIR FLOW m³/h	WING ANGLE
	SPEED r.p.m						
ARMO-A / 400-6 / 0,75 - 2A	2900		400	0,75	1,6	5250	16°
ARMO-A / 400-6 / 1,1 - 2A	2900		400	1,1	2,3	6904	22°
ARMO-A / 400-6 / 1,5 - 2A	2900		400	1,5	3,4	8978	30°
ARMO-A / 400-6 / 2,2 - 2A	2900		400	2,2	4,48	9975	34°
ARMO-A / 450-6 / 1,1 - 2A	2900		450	1,1	2,3	6248	10°
ARMO-A / 450-6 / 1,5 - 2A	2900		450	1,5	3,4	8610	16°
ARMO-A / 450-6 / 2,2 - 2A	2900		450	2,2	4,48	11970	24°
ARMO-A / 450-6 / 3 - 2A	2900		450	3	6	13545	28°
ARMO-A / 500-6 / 2,2 - 2A	2900		500	2,2	4,48	11000	14°
ARMO-A / 500-6 / 3 - 2A	2900		500	3	6	14595	20°
ARMO-A / 500-6 / 4 - 2A	2900		500	4	7,4	17325	26°
ARMO-A / 500-6 / 5,5 - 2A	2900		500	5,5	11	18375	28°
ARMO-A / 560-6 / 4 - 2A	2900		560	4	7,4	17850	14°
ARMO-A / 560-6 / 5,5 - 2A	2900		560	5,5	11	22313	20°
ARMO-A / 560-6 / 7,5 - 2A	2800		560	7,5	13,6	25725	24°
ARMO-A / 630-6 / 5,5 - 2A	2900		630	5,5	11	20475	10°
ARMO-A / 630-6 / 7,5 - 2A	2800		630	7,5	13,6	27300	16°

4 POLE TYPE	SPEED	DIAMETER	POWER	CURRENT	AIR FLOW	WING ANGLE
	r.p.m	mm	kW	230V - 400V	m ³ /h	
ARMO-A / 500-6 / 0,55- 4A	1415	500	0,55	1,6	8715	26
ARMO-A / 500-6 / 0,75- 4A	1350	500	0,75	2,1	10290	32
ARMO-A / 500-6 / 1,1- 4A	1400	500	1,1	2,6	12600	38
ARMO-A / 560-6 / 0,55- 4A	1415	560	0,55	1,6	9870	16
ARMO-A / 560-6 / 0,75- 4A	1350	560	0,75	2,1	12075	22
ARMO-A / 560-6 / 1,1- 4A	1400	560	1,1	2,6	13860	26
ARMO-A / 560-6 / 1,5- 4A	1405	560	1,5	3,5	15750	32
ARMO-A / 560-6 / 2,2- 4A	1410	560	2,2	5	17850	38
ARMO-A / 630-6 / 0,75- 4A	1350	630	0,75	2,1	10605	10
ARMO-A / 630-6 / 1,1- 4A	1400	630	1,1	2,6	16275	20
ARMO-A / 630-6 / 1,5- 4A	1405	630	1,5	3,5	18375	24
ARMO-A / 630-6 / 2,2- 4A	1410	630	2,2	5	21525	30
ARMO-A / 630-6 / 3- 4A	1410	630	3	6,6	24150	36
ARMO-A / 630-6 / 4- 4A	1500	630	4	8,2	25200	38
ARMO-A / 710-3 / 0,75- 4A	1350	710	0,75	2,1	14175	10
ARMO-A / 710-3 / 1,1- 4A	1400	710	1,1	2,6	18375	16
ARMO-A / 710-3 / 1,5- 4A	1405	710	1,5	3,5	21000	20
ARMO-A / 710-3 / 2,2- 4A	1410	710	2,2	5	24413	26
ARMO-A / 710-3 / 3- 4A	1410	710	3	6,6	27825	32
ARMO-A / 710-6 / 1,1- 4A	1400	710	1,1	2,6	16275	12
ARMO-A / 710-6 / 1,5- 4A	1405	710	1,5	3,5	20475	18
ARMO-A / 710-6 / 2,2- 4A	1410	710	2,2	5	23625	22
ARMO-A / 710-6 / 3- 4A	1410	710	3	6,6	28350	28
ARMO-A / 710-6 / 4- 4A	1415	710	4	8,2	31500	32
ARMO-A / 800-6 / 2,2- 4A	1410	800	2,2	5	24150	14
ARMO-A / 800-6 / 3- 4A	1410	800	3	6,6	30450	20
ARMO-A / 800-6 / 4- 4A	1415	800	4	8,2	32550	22
ARMO-A / 800-6 / 5,5- 4A	1430	800	5,5	11,2	38850	28
ARMO-A / 800-6 / 7,5- 4A	1440	800	7,5	15,4	42525	32
ARMO-A / 800-9 / 2,2- 4A	1410	800	2,2	5	16275	10
ARMO-A / 800-9 / 3- 4A	1410	800	3	6,6	21525	14
ARMO-A / 800-9 / 4- 4A	1415	800	4	8,2	29400	20
ARMO-A / 800-9 / 5,5- 4A	1430	800	5,5	11,2	36488	26
ARMO-A / 800-9 / 7,5- 4A	1440	800	7,5	15,4	40950	30
ARMO-A / 800-9 / 11- 4A	1450	800	11	21	43050	32
ARMO-A / 900-6 / 4- 4A	1415	900	4	8,2	31500	12
ARMO-A / 900-6 / 5,5- 4A	1430	900	5,5	11,2	38850	16
ARMO-A / 900-6 / 7,5- 4A	1440	900	7,5	15,4	47775	22
ARMO-A / 900-6 / 11- 4A	1450	900	11	21	56700	28
ARMO-A / 900-6 / 15- 4A	1450	900	15	29,3	60900	32
ARMO-A / 900-9 / 4- 4A	1415	900	4	8,2	26775	10
ARMO-A / 900-9 / 5,5- 4A	1430	900	5,5	11,2	34125	14
ARMO-A / 900-9 / 7,5- 4A	1440	900	7,5	15,4	41213	18
ARMO-A / 900-9 / 11- 4A	1450	900	11	21	54600	26
ARMO-A / 900-9 / 15- 4A	1450	900	15	29,3	63525	32
ARMO-A / 1000-6 / 5,5- 4A	1430	1000	5,5	11,2	38850	12
ARMO-A / 1000-6 / 7,5- 4A	1440	1000	7,5	15,4	47775	18
ARMO-A / 1000-6 / 11- 4A	1450	1000	11	21	56700	22
ARMO-A / 1000-6 / 15- 4A	1450	1000	15	29,3	60900	28
ARMO-A / 1000-6 / 18,5- 4A	1455	1000	18,5	34,5	56700	32
ARMO-A / 1000-9 / 7,5- 4A	1440	1000	7,5	15,4	43050	12
ARMO-A / 1000-9 / 11- 4A	1450	1000	11	21	55650	18
ARMO-A / 1000-9 / 15- 4A	1450	1000	15	29,3	69300	24
ARMO-A / 1000-9 / 18,5- 4A	1455	1000	18,5	34,5	77700	28
ARMO-A / 1000-9 / 22- 4A	1460	1000	22	42,5	81900	30
ARMO-A / 1000-9 / 30- 4A	1460	1000	30	55	86100	32
ARMO-A / 1250-6 / 15- 4A	1450	1250	15	29,3	90300	12
ARMO-A / 1250-6 / 18,5- 4A	1455	1250	18,5	34,5	103950	16
ARMO-A / 1250-6 / 22- 4A	1460	1250	22	42,5	109725	18
ARMO-A / 1250-6 / 30- 4A	1460	1250	30	55	122850	22
ARMO-A / 1250-6 / 37- 4A	1470	1250	37	67	136500	26
ARMO-A / 1250-6 / 45- 4A	1475	1250	45	80	155400	32
ARMO-A / 1250-9 / 18,5- 4A	1455	1250	18,5	34,5	89250	12
ARMO-A / 1250-9 / 22- 4A	1460	1250	22	42,5	97650	14
ARMO-A / 1250-9 / 30- 4A	1460	1250	30	55	114975	18
ARMO-A / 1250-9 / 37- 4A	1470	1250	37	67	131250	22
ARMO-A / 1250-9 / 45- 4A	1475	1250	45	80	138600	24

6 POLE TYPE	SPEED	DIAMETER	POWER	CURRENT	AIR FLOW	WING ANGLE
	r.p.m	mm	kW	230V - 400V	m ³ /h	
ARMO-A / 500-6 / 0,37- 6A	900	500	0,37	1,1	8400	38
ARMO-A / 560-6 / 0,37- 6A	900	560	0,37	1,1	10500	32
ARMO-A / 560-6 / 0,55- 6A	930	560	0,55	1,5	11760	38
ARMO-A / 630-6 / 0,37- 6A	900	630	0,37	1,1	11576	22
ARMO-A / 630-6 / 0,55- 6A	930	630	0,55	1,5	13650	28
ARMO-A / 630-6 / 0,75- 6A	945	630	0,75	2	14963	32
ARMO-A / 630-6 / 1,1- 6A	945	630	1,1	2,9	16800	38
ARMO-A / 710-3 / 0,37- 6A	900	710	0,37	1,1	13125	18
ARMO-A / 710-3 / 0,55- 6A	930	710	0,55	1,5	16538	26
ARMO-A / 710-3 / 0,75- 6A	945	710	0,75	2	18900	32
ARMO-A / 710-6 / 1,1- 6A	945	710	1,1	2,9	11025	12
ARMO-A / 710-6 / 1,5- 6A	945	710	1,5	3,6	13000	16
ARMO-A / 710-6 / 2,2- 6A	950	710	2,2	5,4	13750	22
ARMO-A / 710-6 / 3- 6A	950	710	3	6,9	18900	28
ARMO-A / 710-6 / 4- 6A	955	710	4	9	21000	32
ARMO-A / 800-6 / 0,55- 6A	930	800	0,55		13125	10
ARMO-A / 800-6 / 1,1- 6A	945	800	1,1	2,9	22050	22
ARMO-A / 800-6 / 1,5- 6A	945	800	1,5	3,6	25200	26
ARMO-A / 800-6 / 2,2- 6A	950	800	2,2	5,4	28350	32
ARMO-A / 800-9 / 0,75- 6A	945	800	0,75	2	14700	14
ARMO-A / 800-9 / 1,1- 6A	945	800	1,1	2,9	19950	20
ARMO-A / 800-9 / 1,5- 6A	945	800	1,5	3,6	23100	24
ARMO-A / 800-9 / 2,2- 6A	950	800	2,2	5,4	27300	30
ARMO-A / 800-9 / 3- 6A	950	800	3	6,9	28350	32
ARMO-A / 900-6 / 1,1- 6A	945	900	1,1	2,9	23100	14
ARMO-A / 900-6 / 1,5- 6A	945	900	1,5	3,6	25200	16
ARMO-A / 900-6 / 2,2- 6A	950	900	2,2	5,4	31500	22
ARMO-A / 900-6 / 3- 6A	950	900	3	6,9	36750	28
ARMO-A / 900-6 / 4- 6A	955	900	4	9	40950	32
ARMO-A / 900-9 / 1,5- 6A	945	900	1,5	3,6	23100	14
ARMO-A / 900-9 / 2,2- 6A	950	900	2,2	5,4	27300	20
ARMO-A / 900-9 / 3- 6A	950	900	3	6,9	35700	24
ARMO-A / 900-9 / 4- 6A	955	900	4	9	39900	30
ARMO-A / 900-9 / 5,5- 6A	985	900	5,5	12,3	43050	32
ARMO-A / 1000-6 / 1,5- 6A	945	1000	1,5	3,6	26250	10
ARMO-A / 1000-6 / 2,2- 6A	950	1000	2,2	5,4	34650	16
ARMO-A / 1000-6 / 3- 6A	950	1000	3	6,9	44100	22
ARMO-A / 1000-6 / 4- 6A	955	1000	4	9	49350	26
ARMO-A / 1000-6 / 5,5- 6A	985	1000	5,5	12,3	55650	32
ARMO-A / 1000-9 / 2,2- 6A	950	1000	2,2	5,4	32550	14
ARMO-A / 1000-9 / 3- 6A	950	1000	3	6,9	39900	20
ARMO-A / 1000-9 / 4- 6A	955	1000	4	9	43050	22
ARMO-A / 1000-9 / 5,5- 6A	985	1000	5,5	12,3	52500	28
ARMO-A / 1000-9 / 7,5- 6A	960	1000	7,5	15	57750	32
ARMO-A / 1250-6 / 4- 6A	955	1250	4	9	60900	12
ARMO-A / 1250-6 / 5,5- 6A	985	1250	5,5	12,3	63300	16
ARMO-A / 1250-6 / 7,5- 6A	960	1250	7,5	15	76650	20
ARMO-A / 1250-6 / 11- 6A	960	1250	11	22	92400	26
ARMO-A / 1250-6 / 15- 6A	965	1250	15	29	105000	32
ARMO-A / 1250-9 / 7,5- 6A	960	1250	7,5	15	73500	16
ARMO-A / 1250-9 / 11- 6A	960	1250	11	22	88200	22
ARMO-A / 1250-9 / 15- 6A	965	1250	15	29	105000	28
ARMO-A / 1250-9 / 18,5- 6A	970	1250	18,5	36,5	115500	32

Accessories

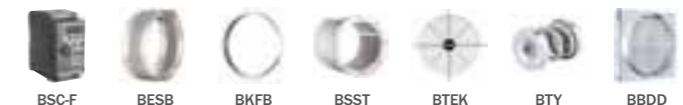

BSC-F BESB BKFB BSST BTEK BTY BBDD

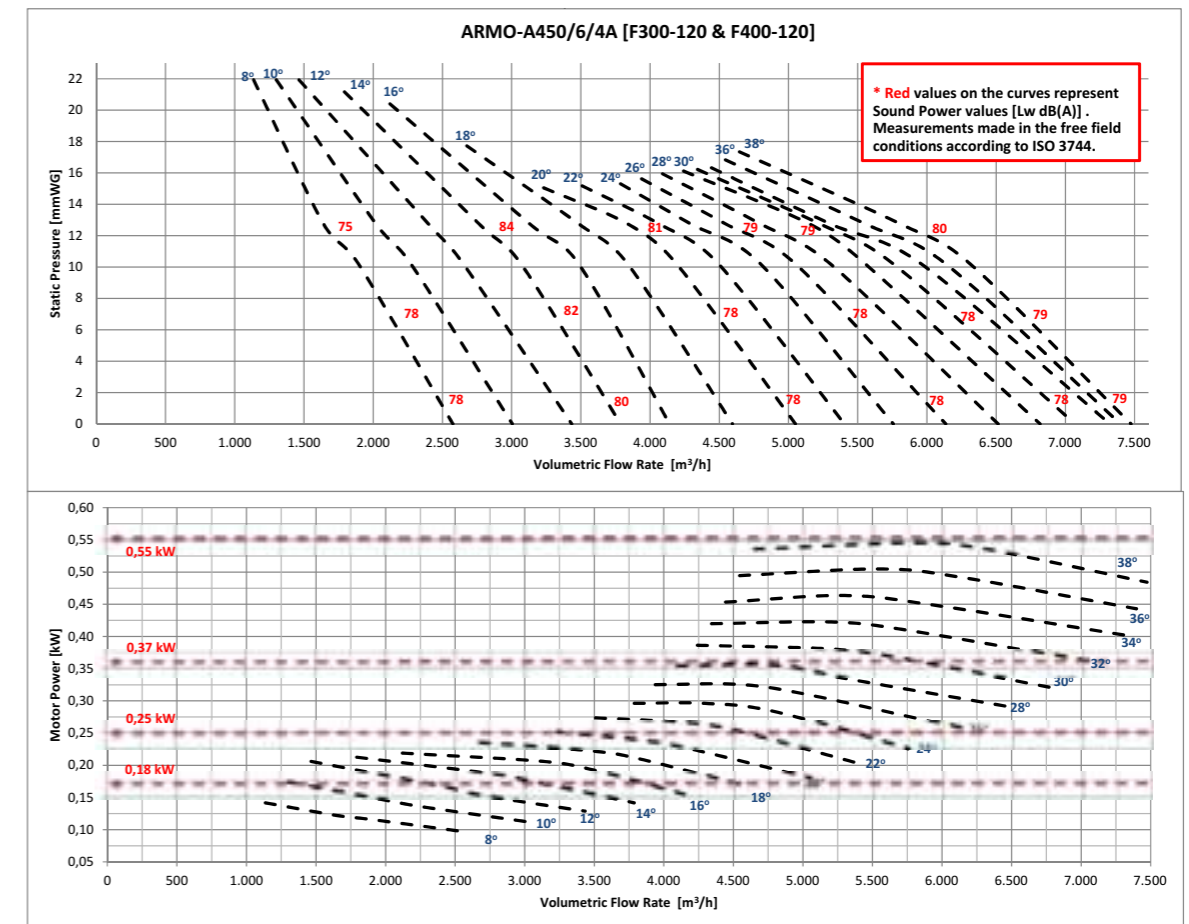
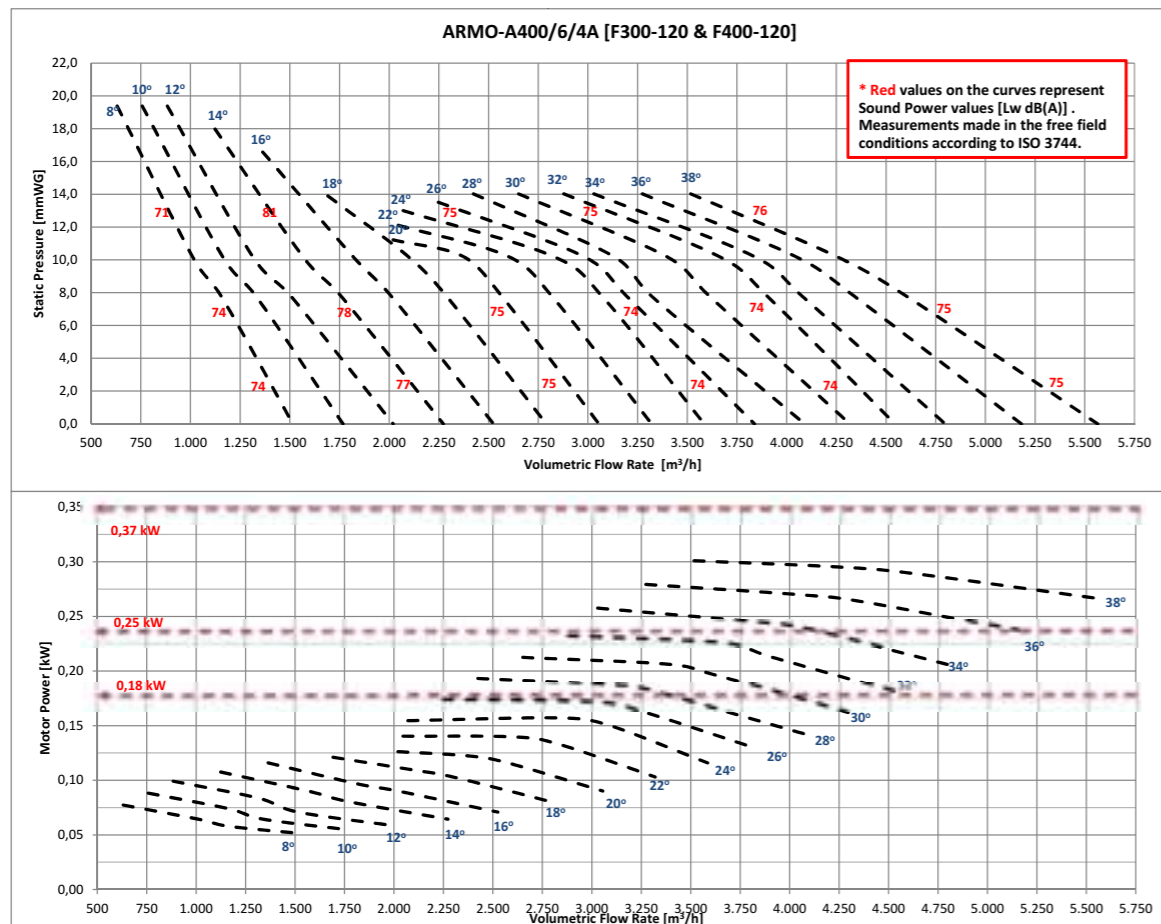
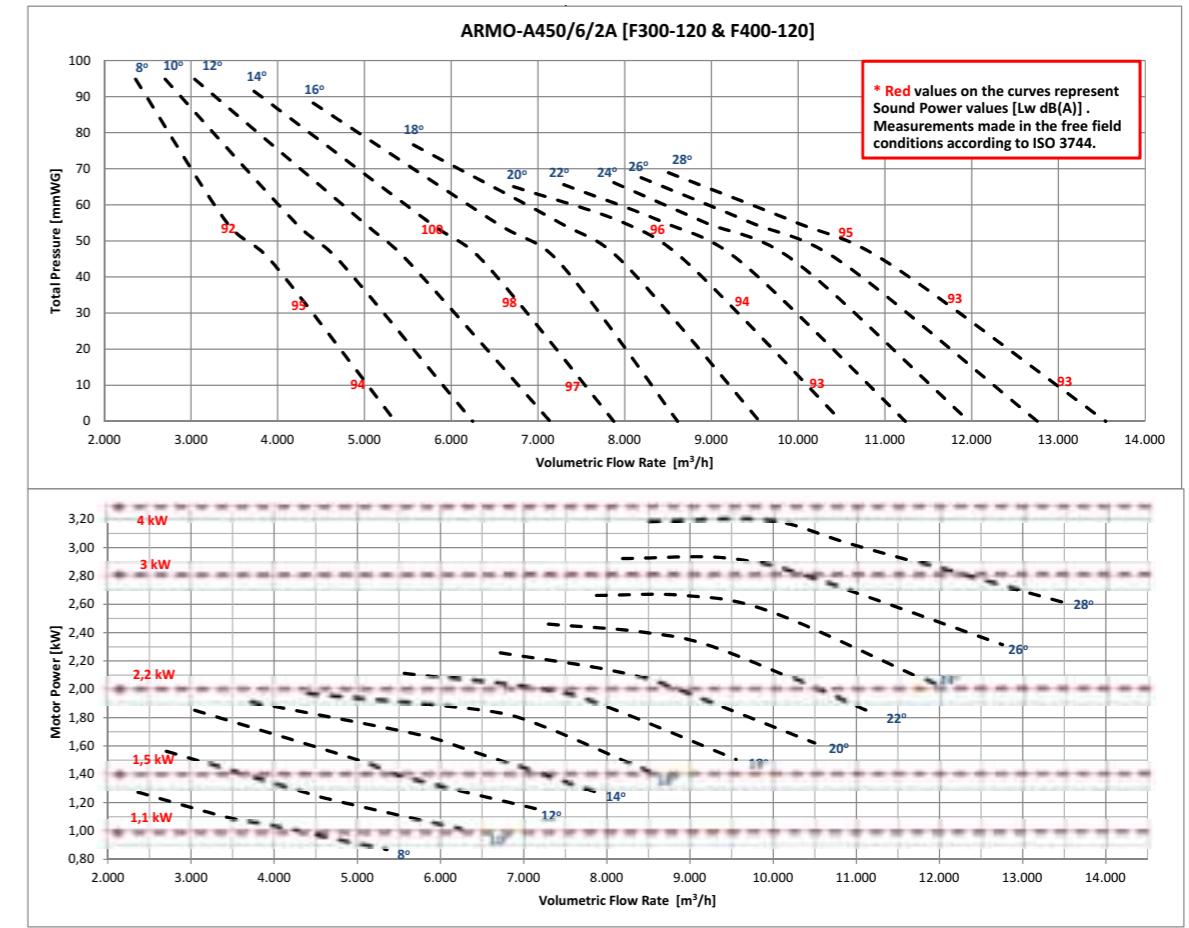
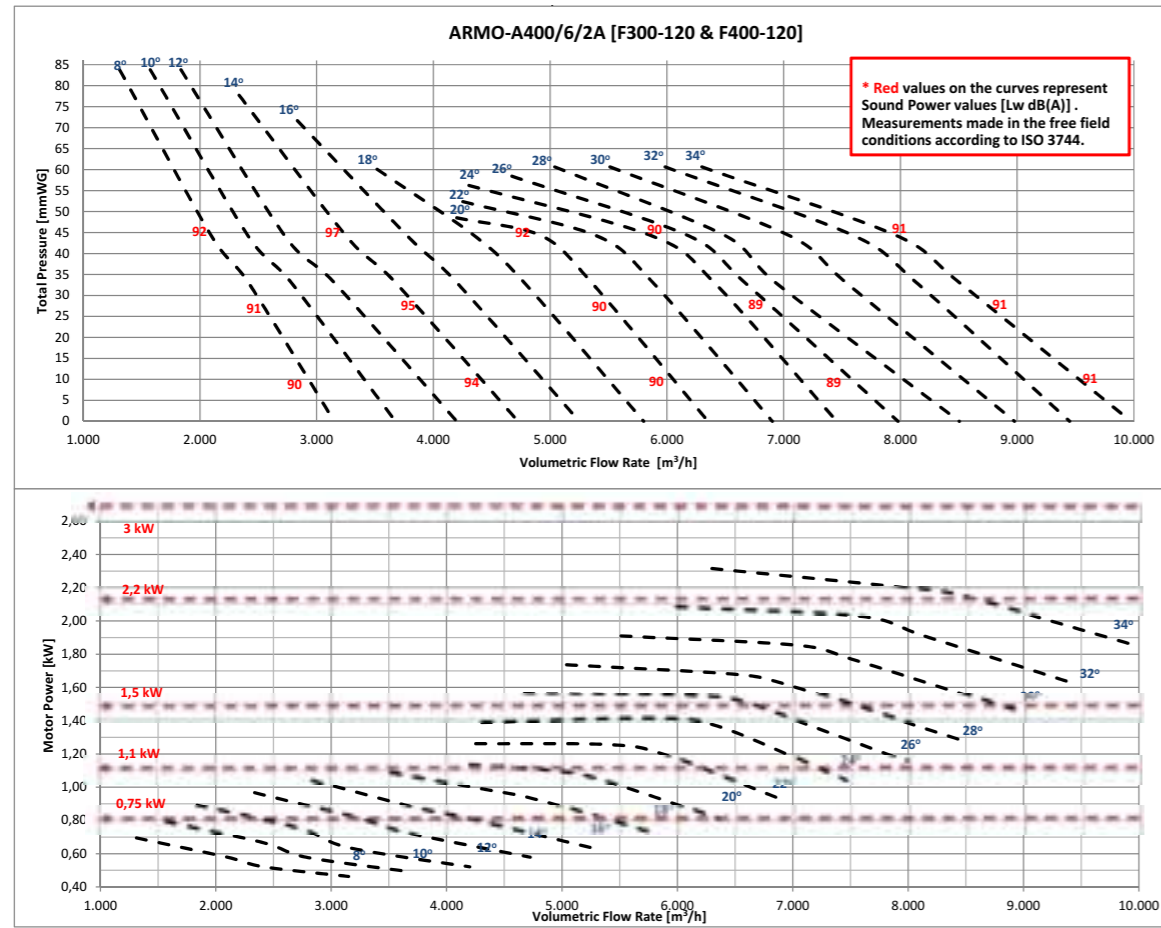

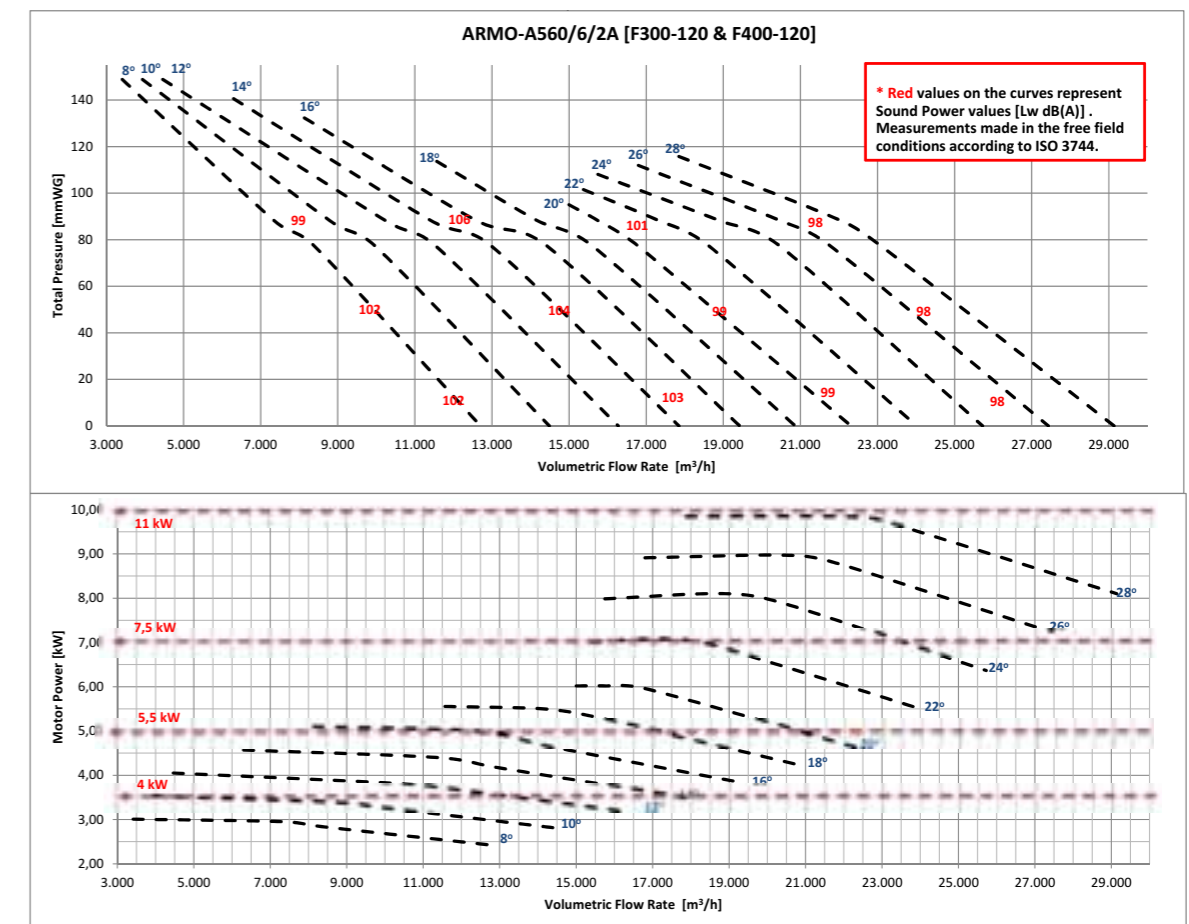
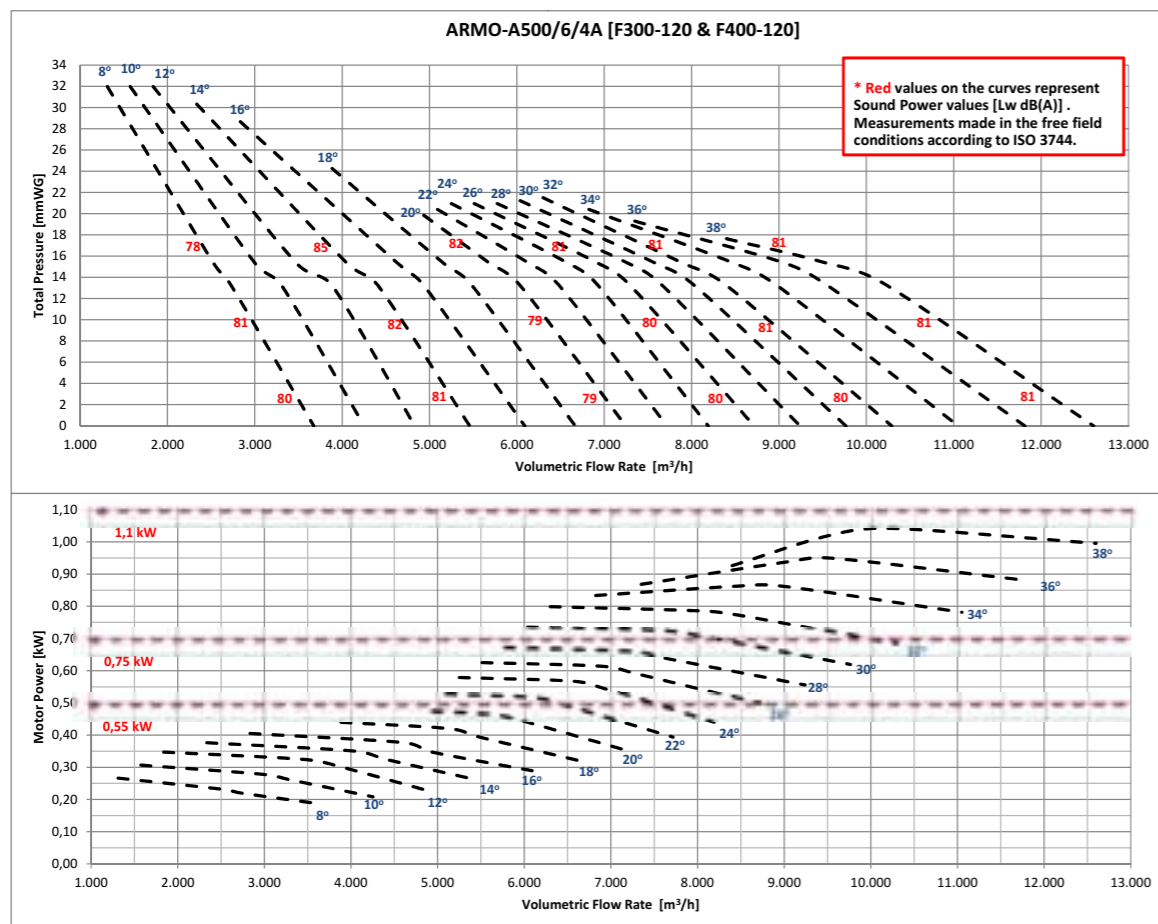
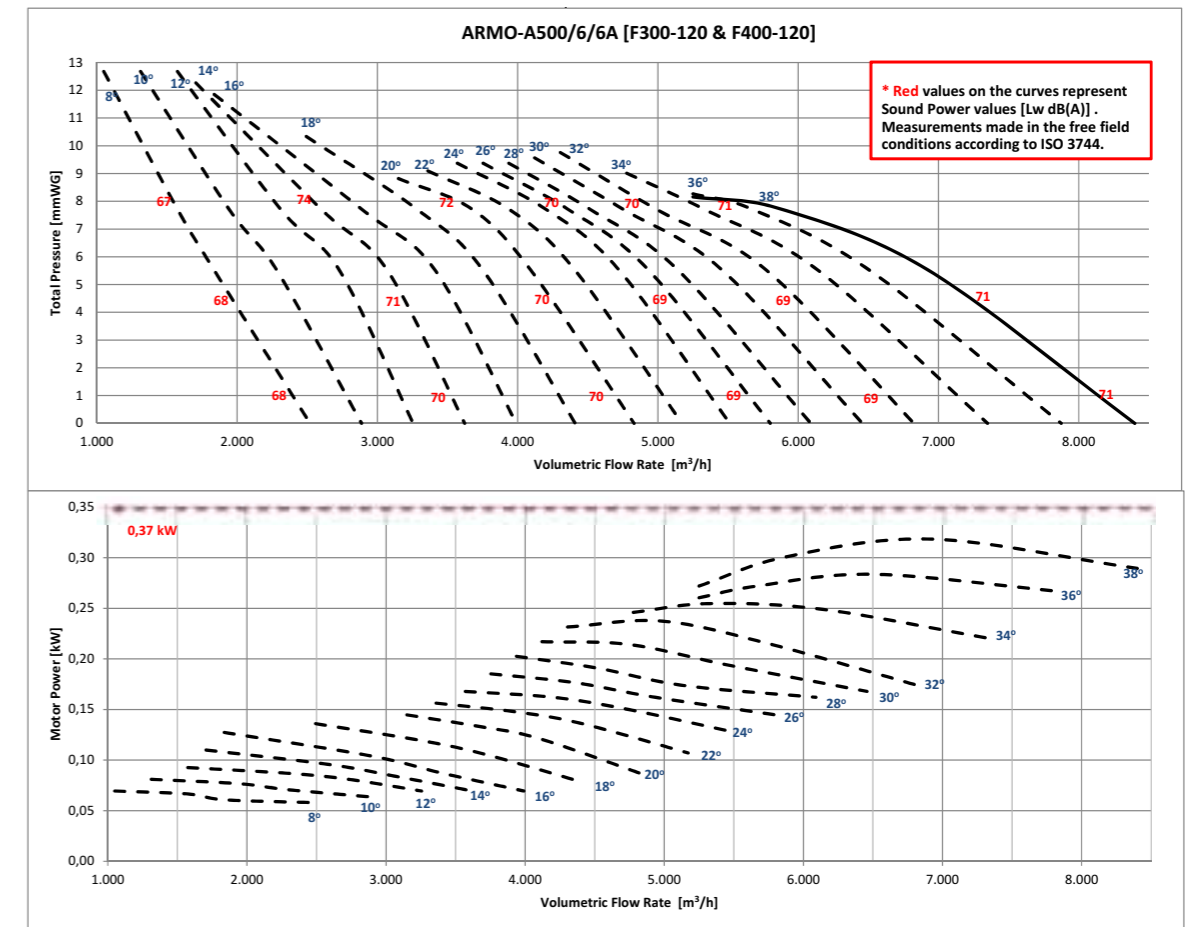
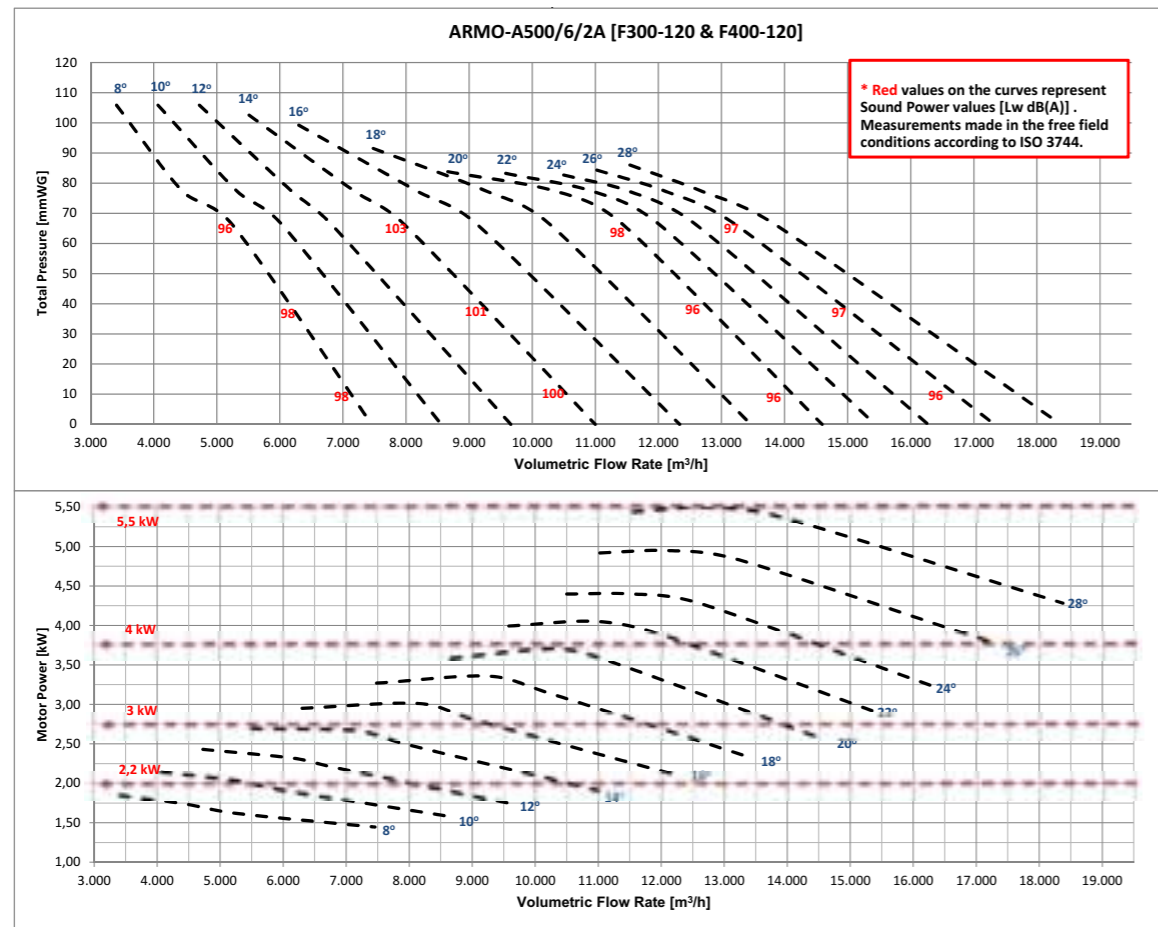

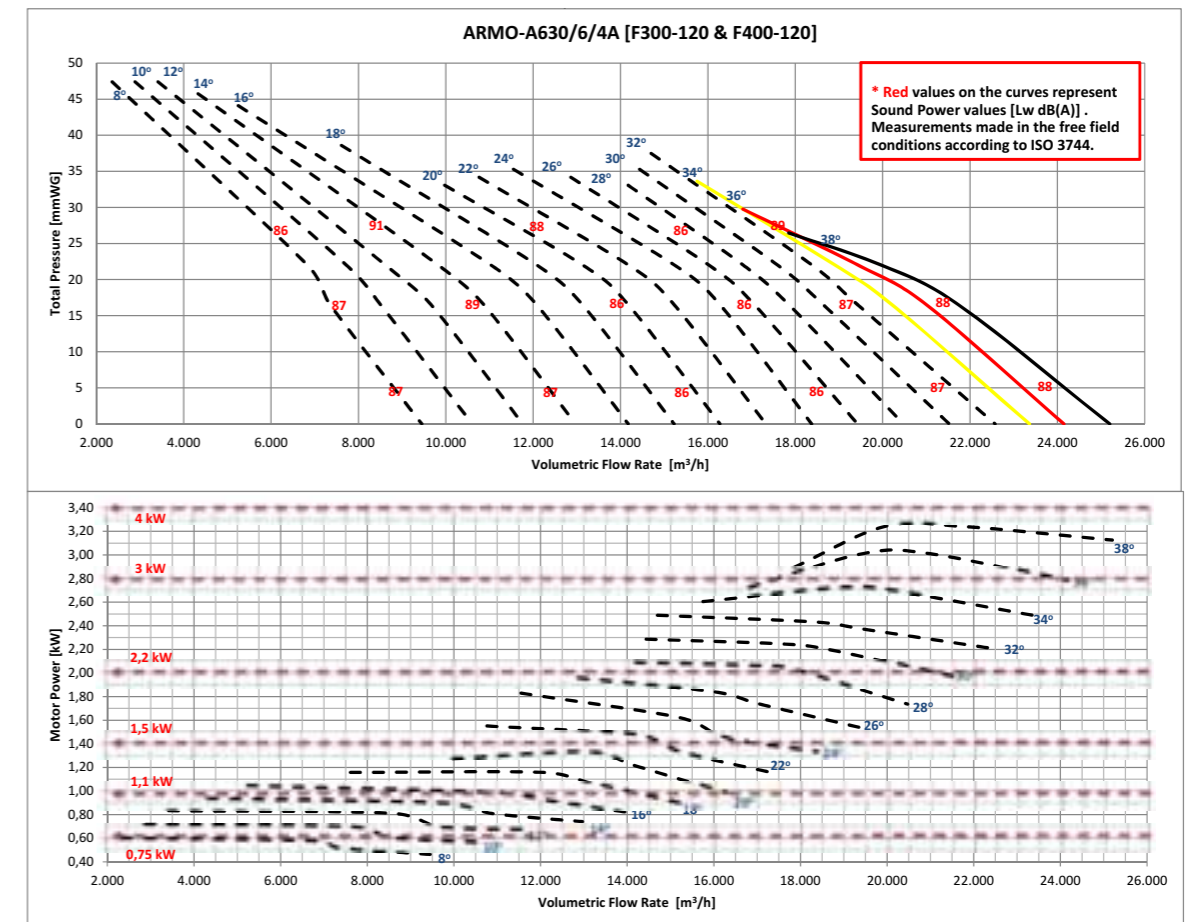
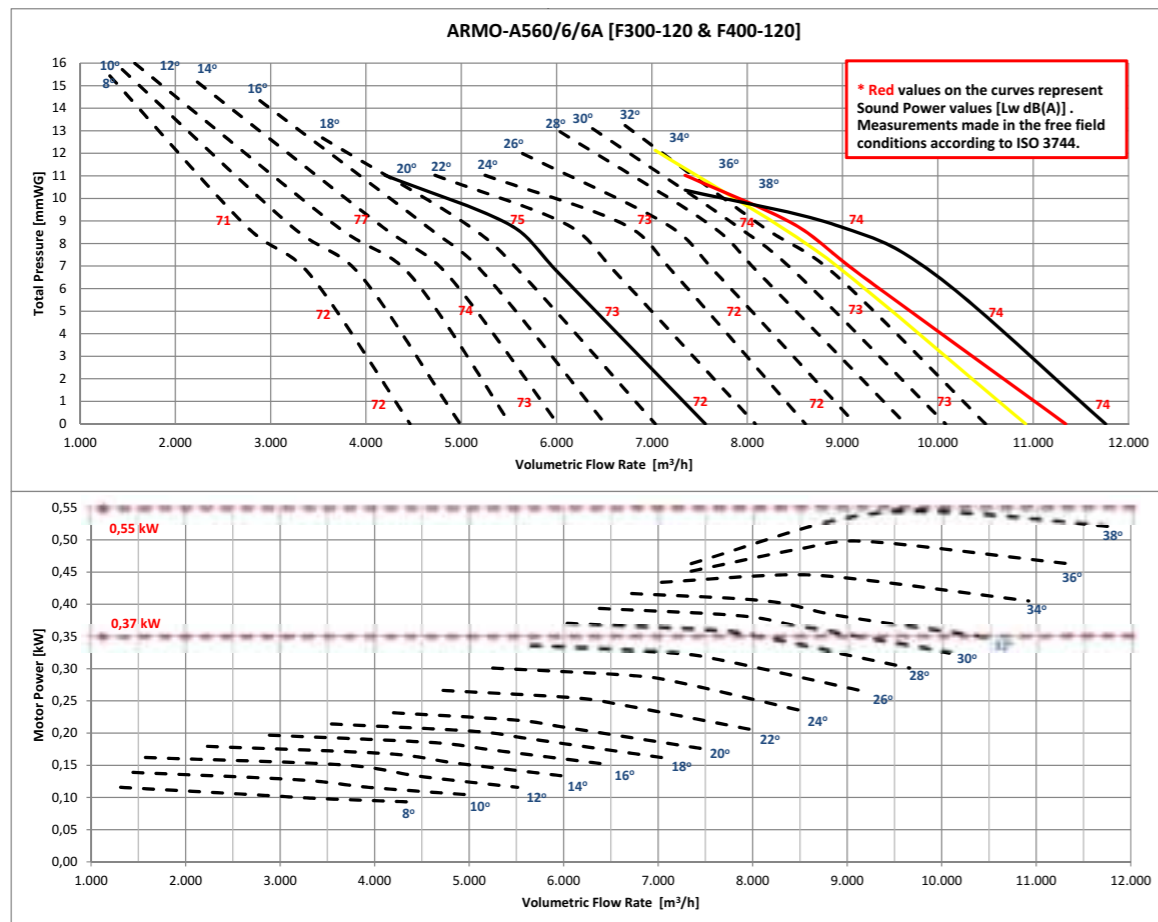
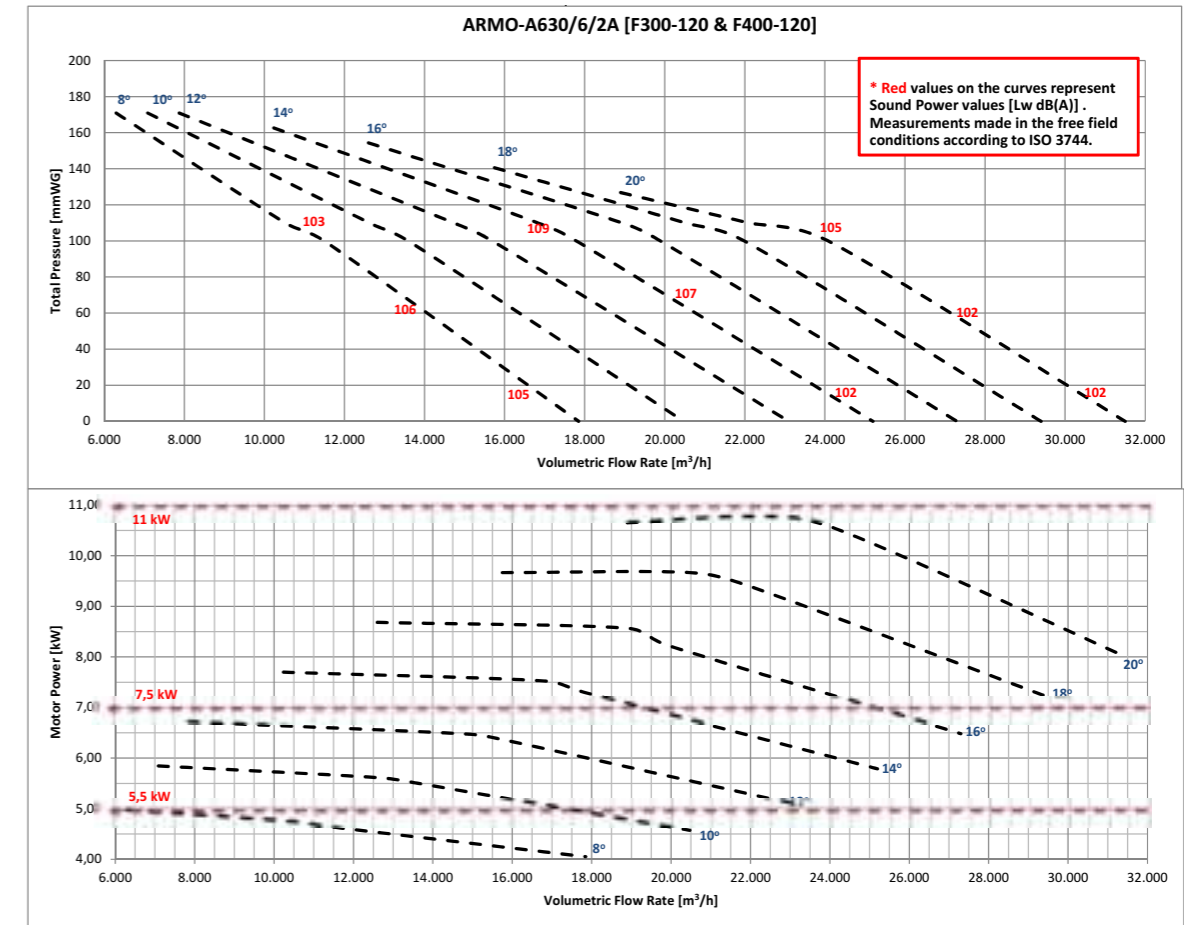
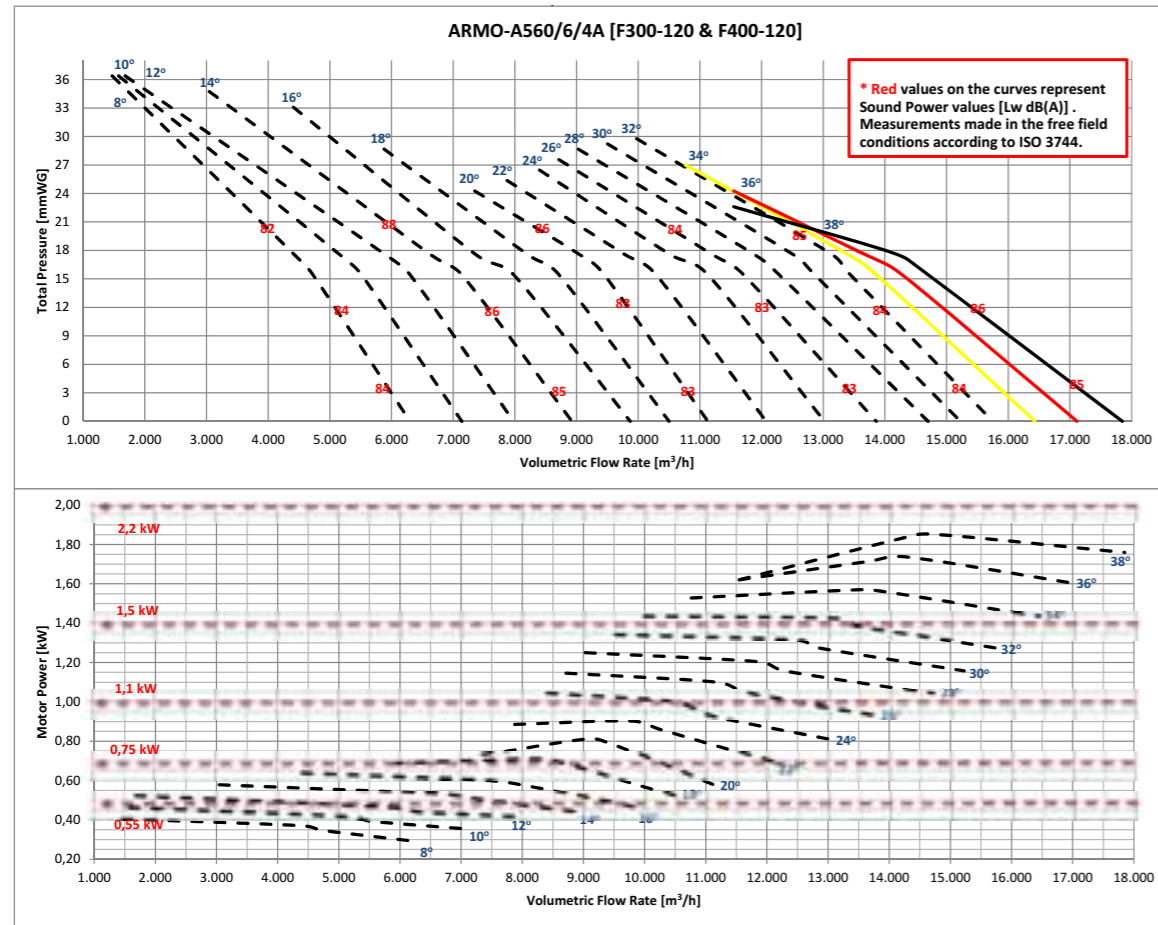

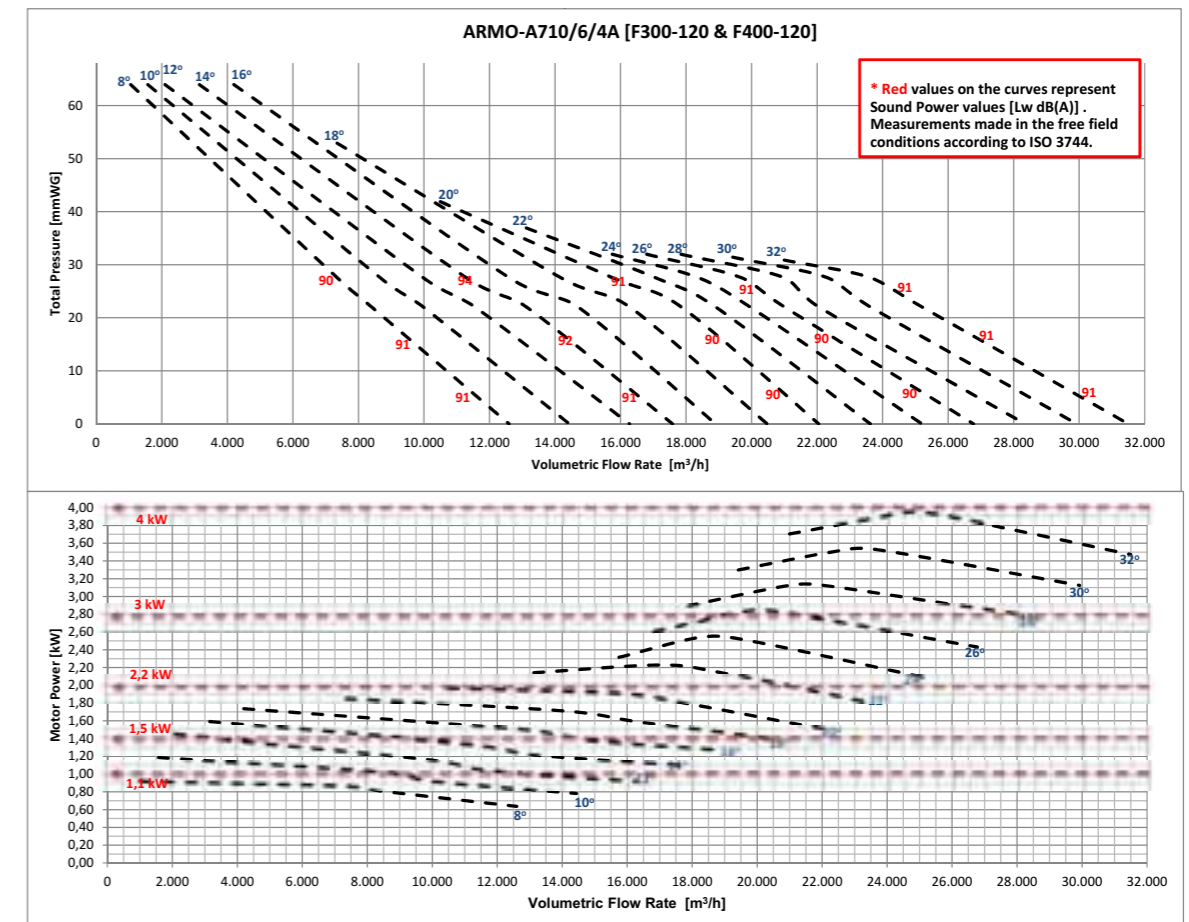
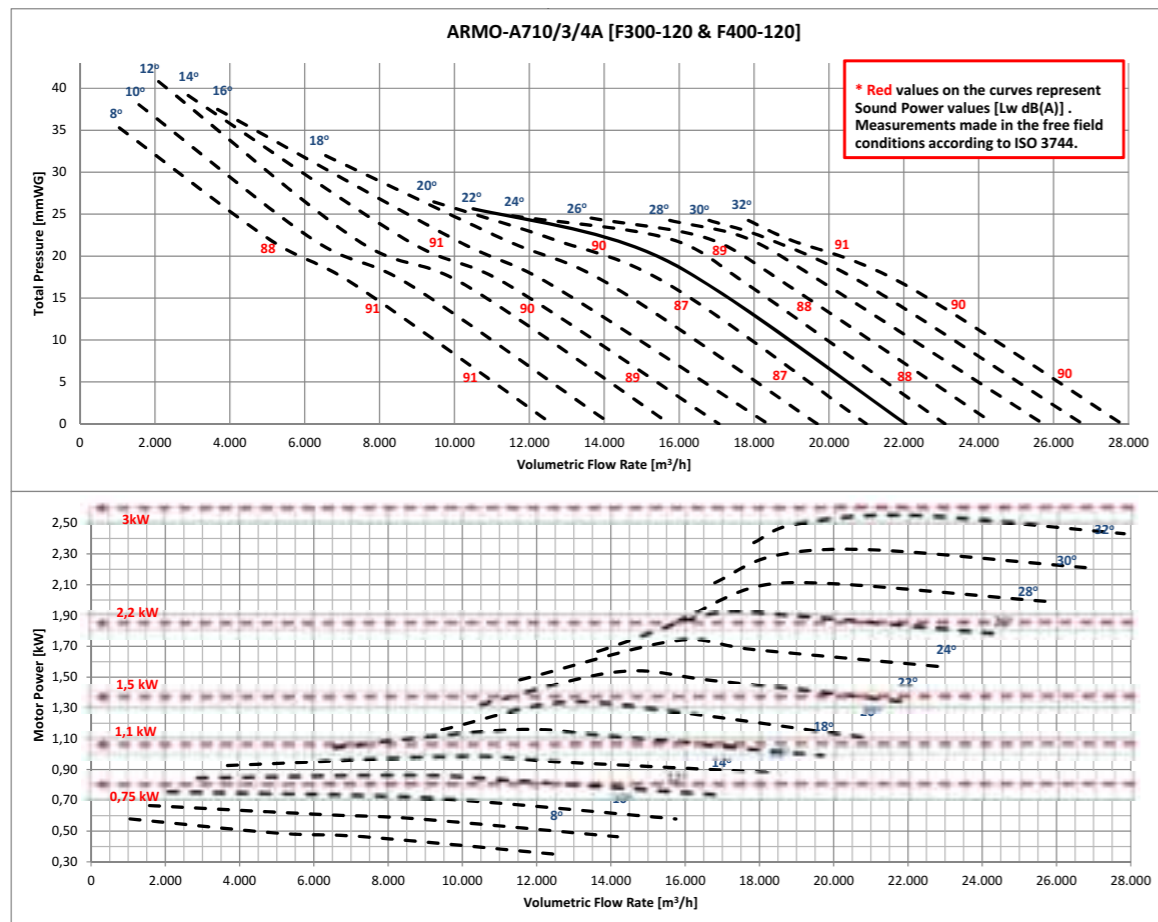
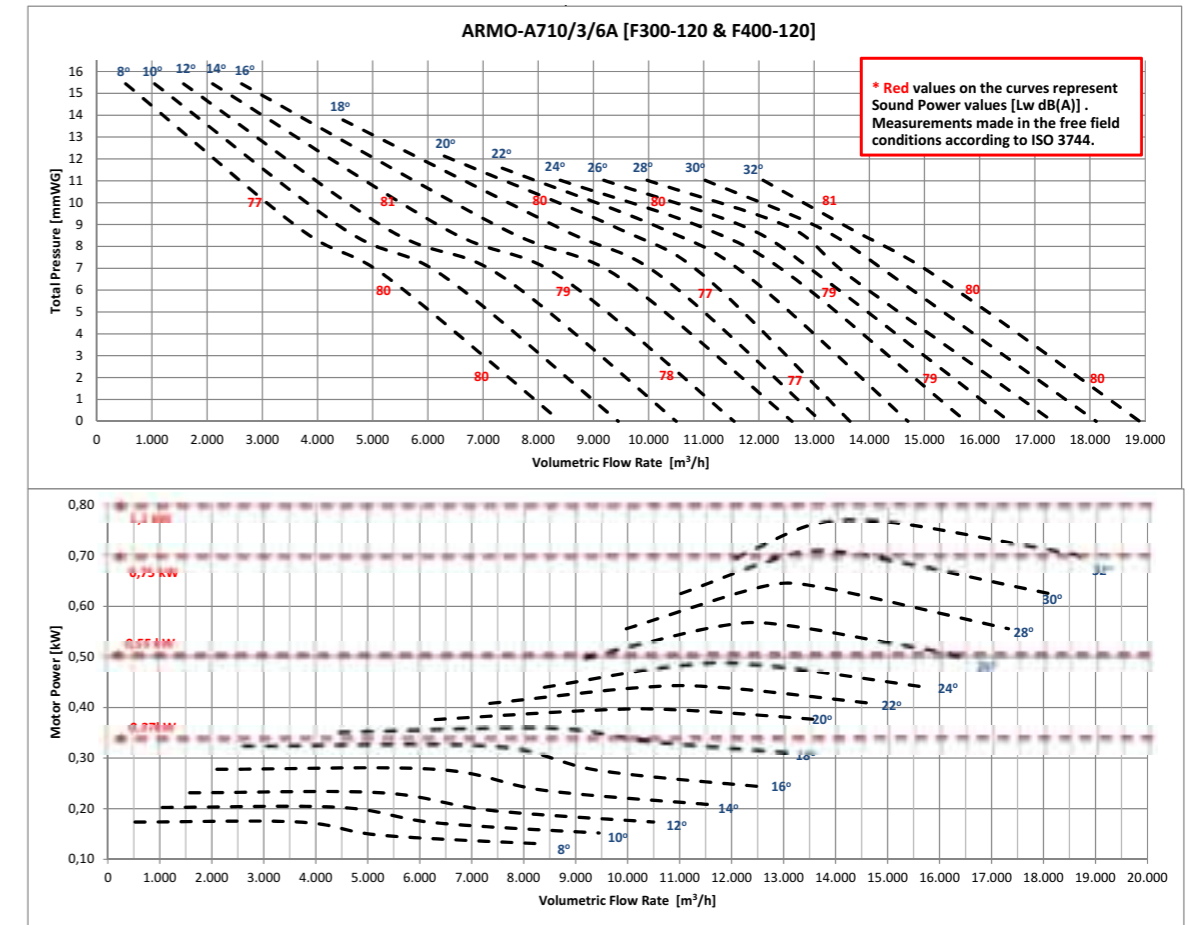
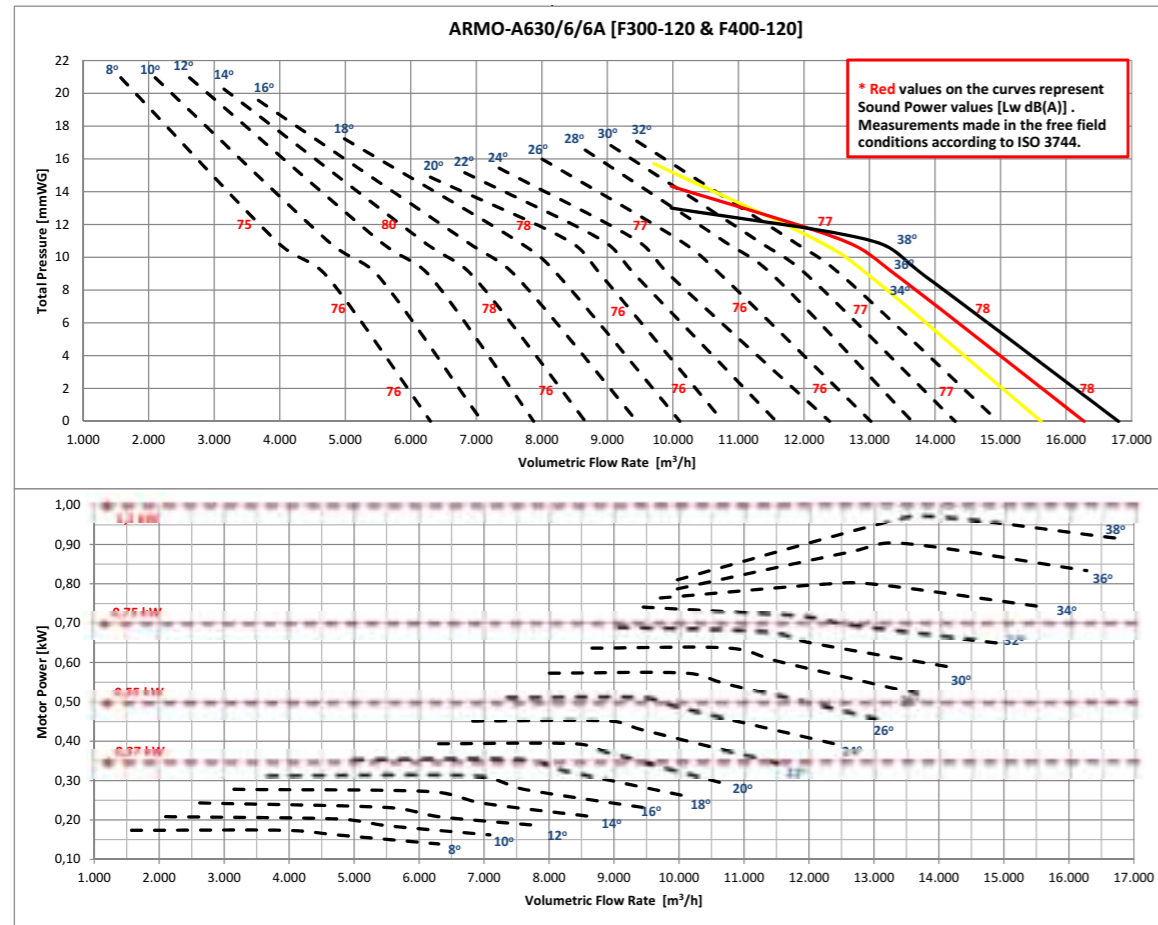

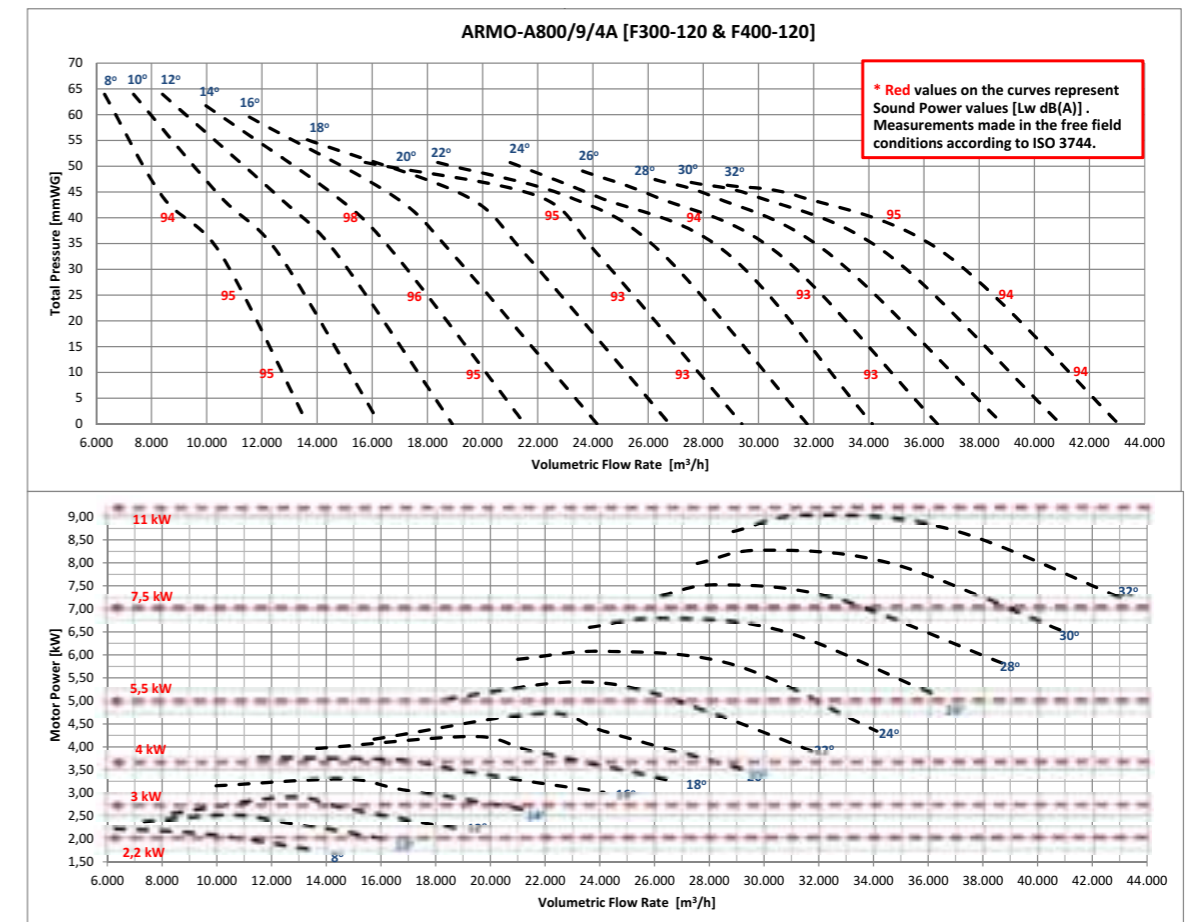
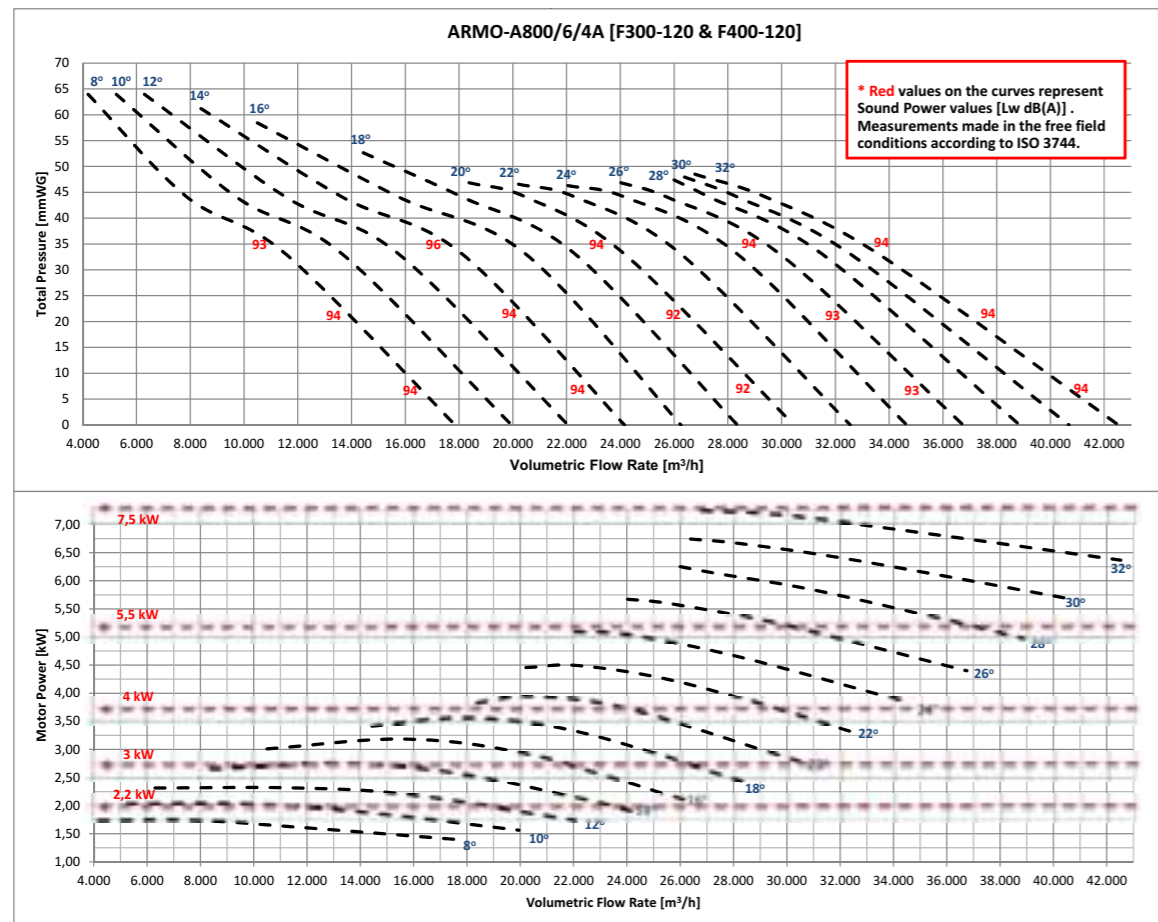
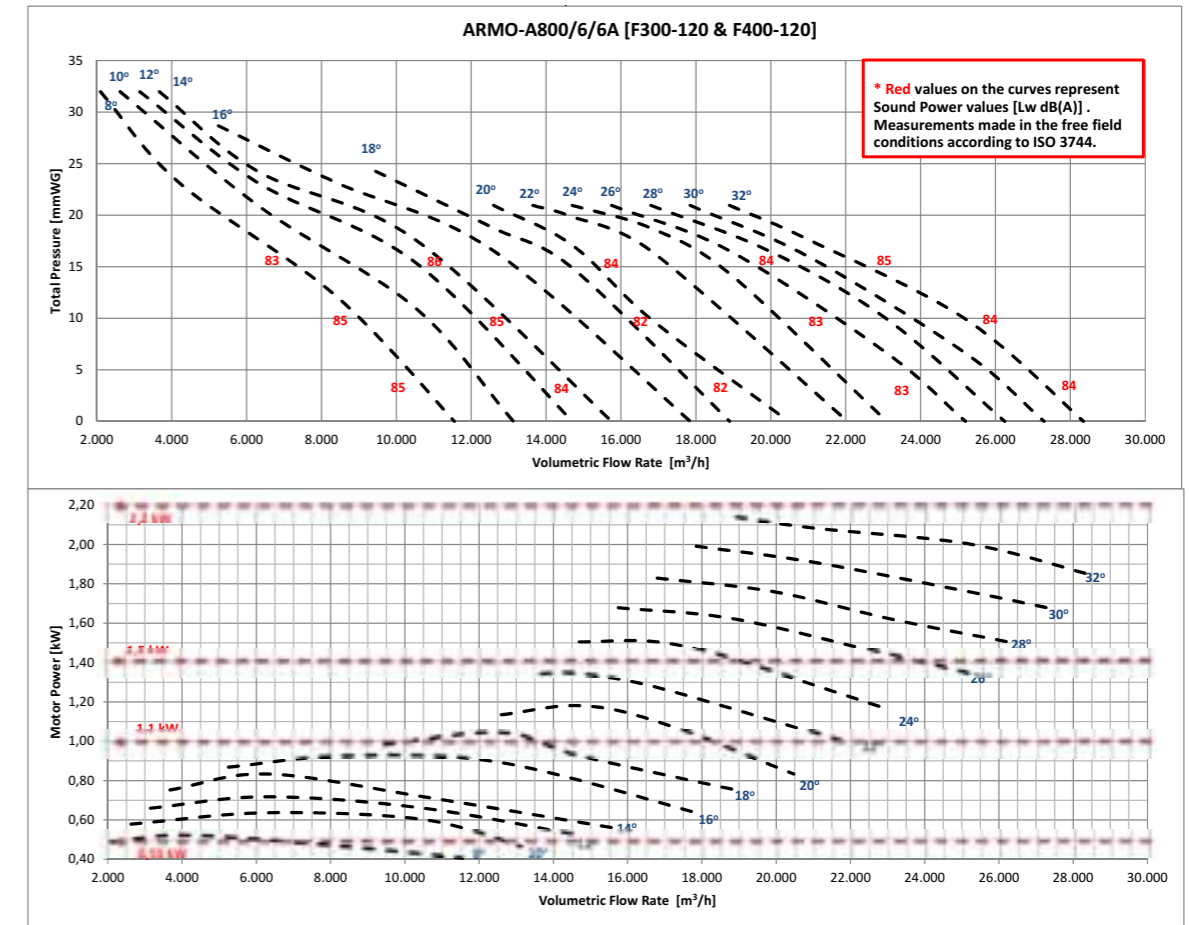
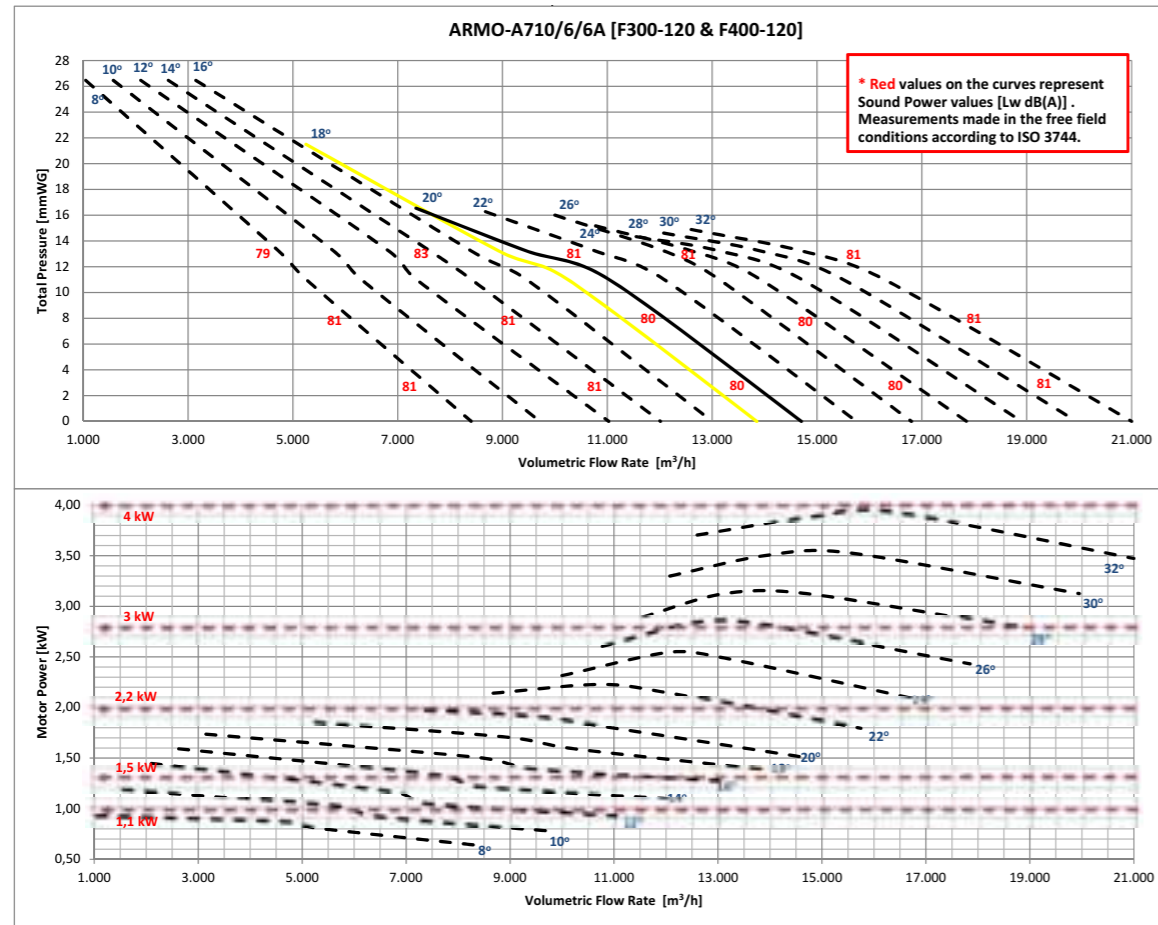

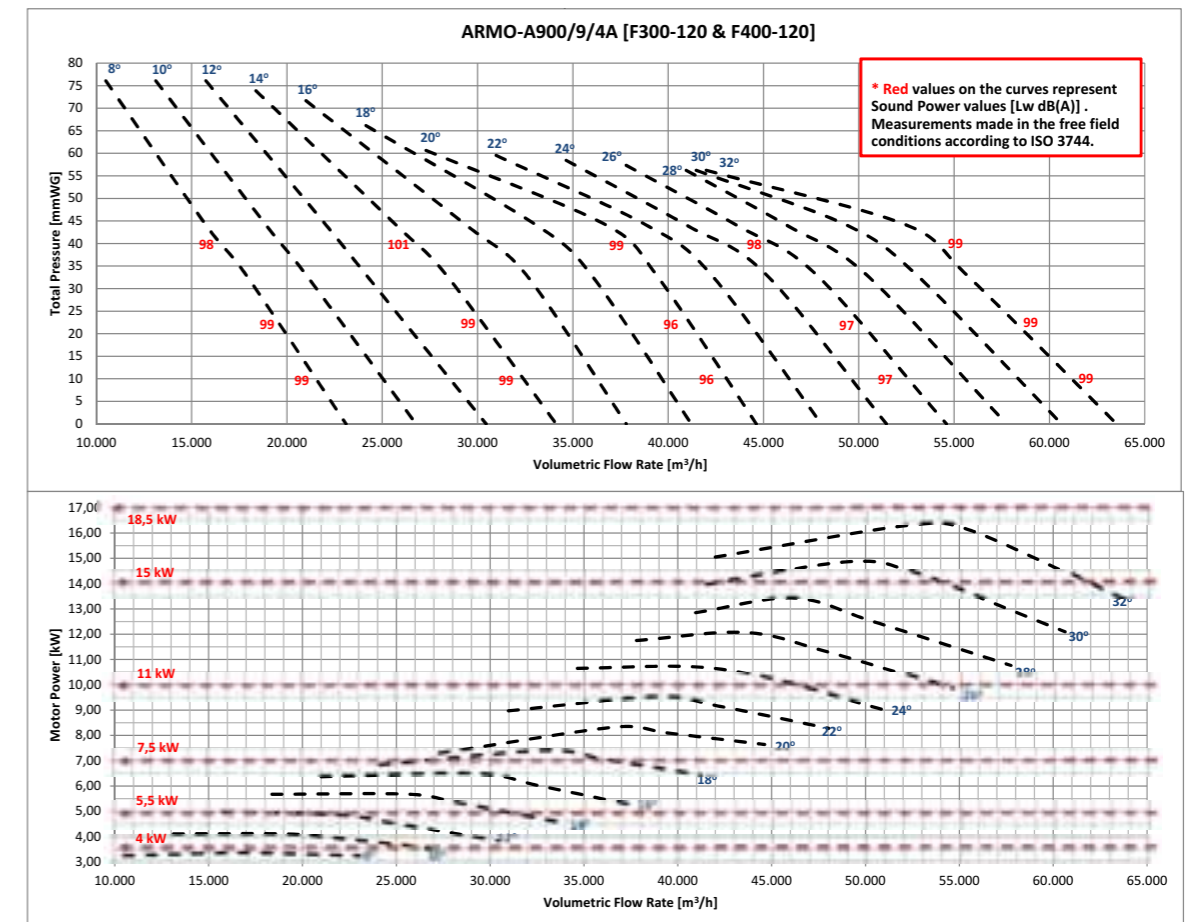
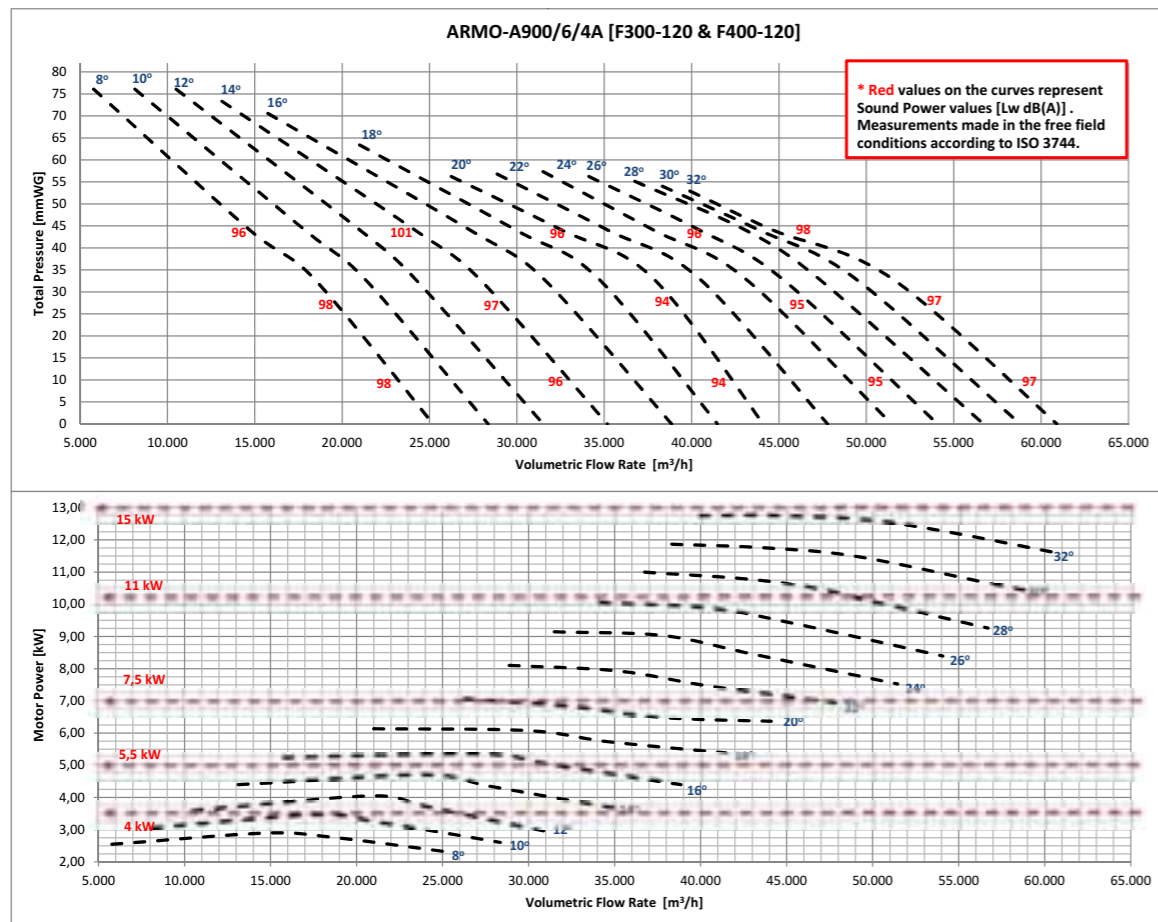
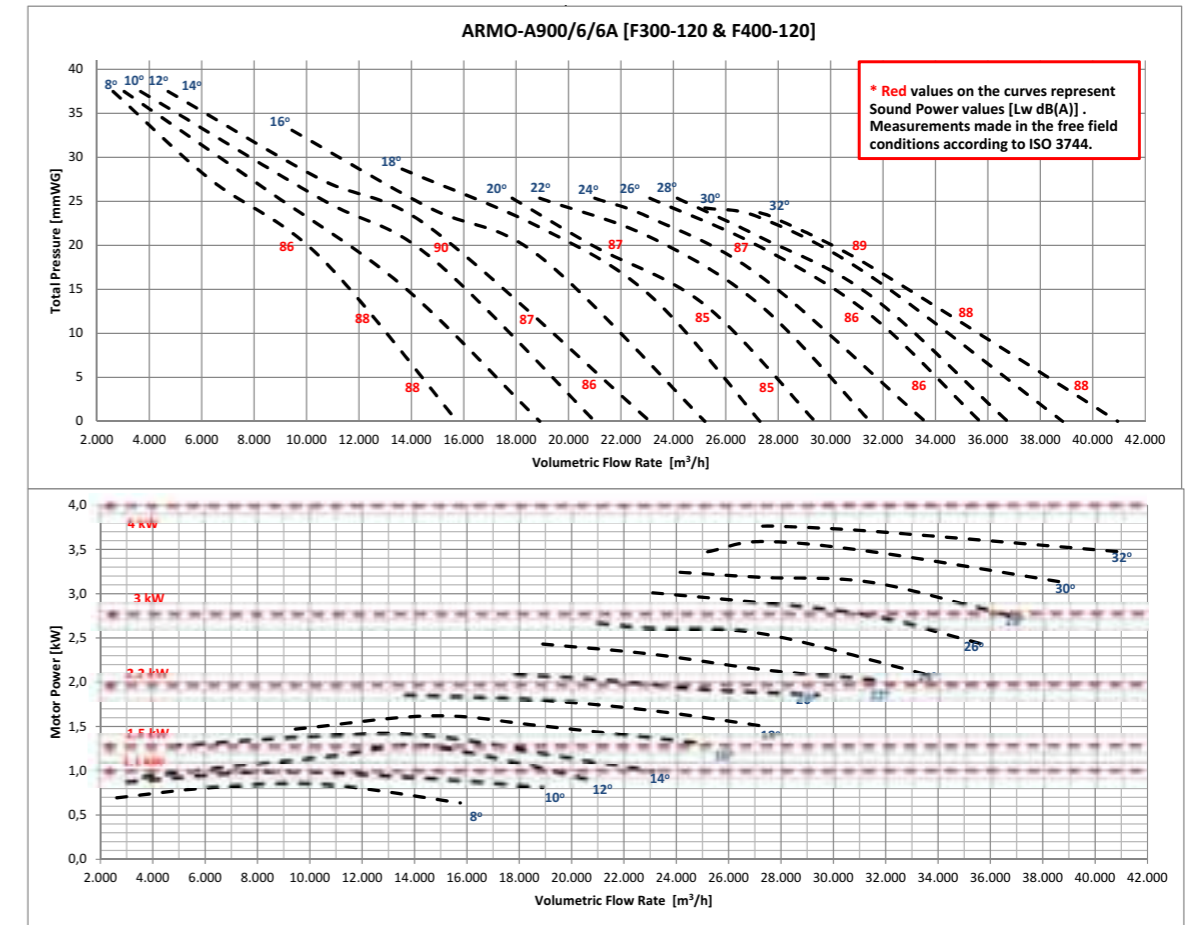
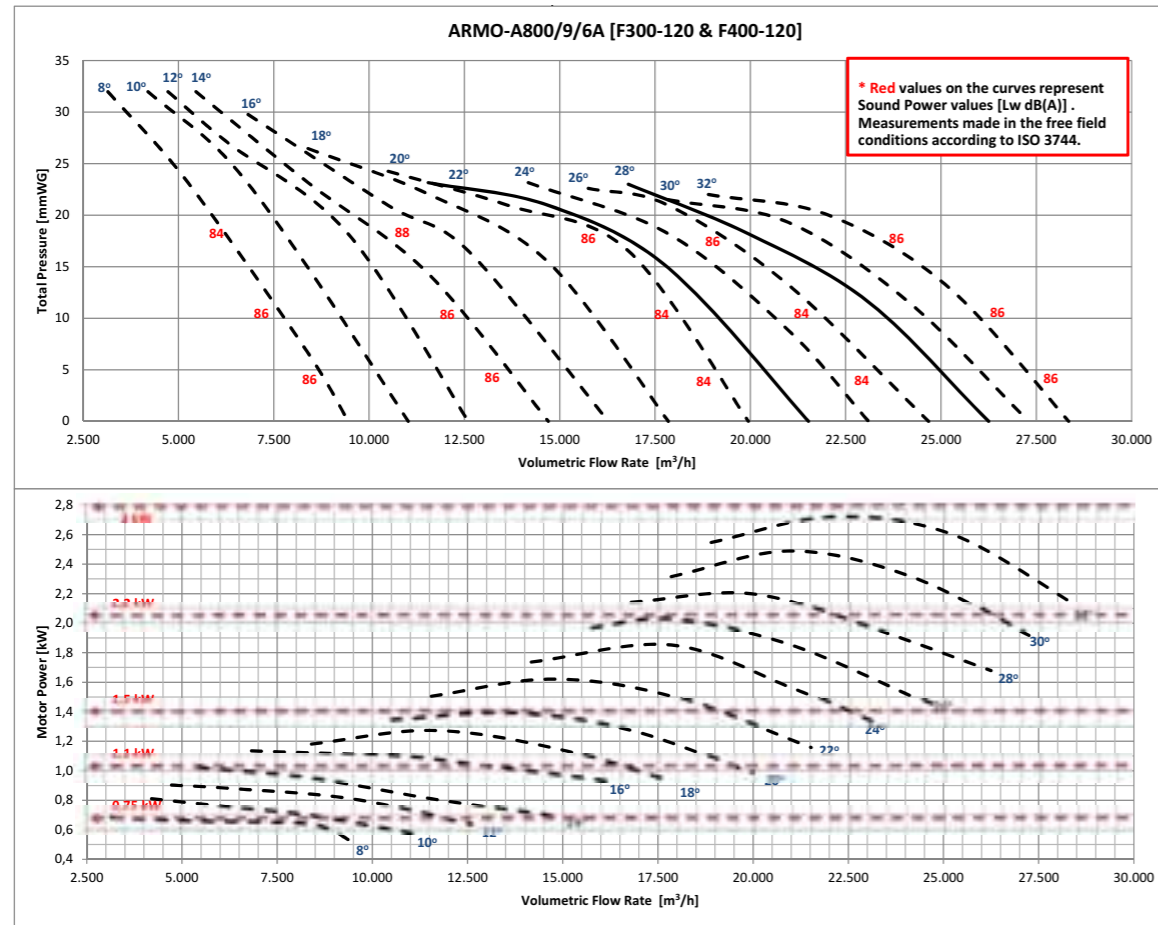

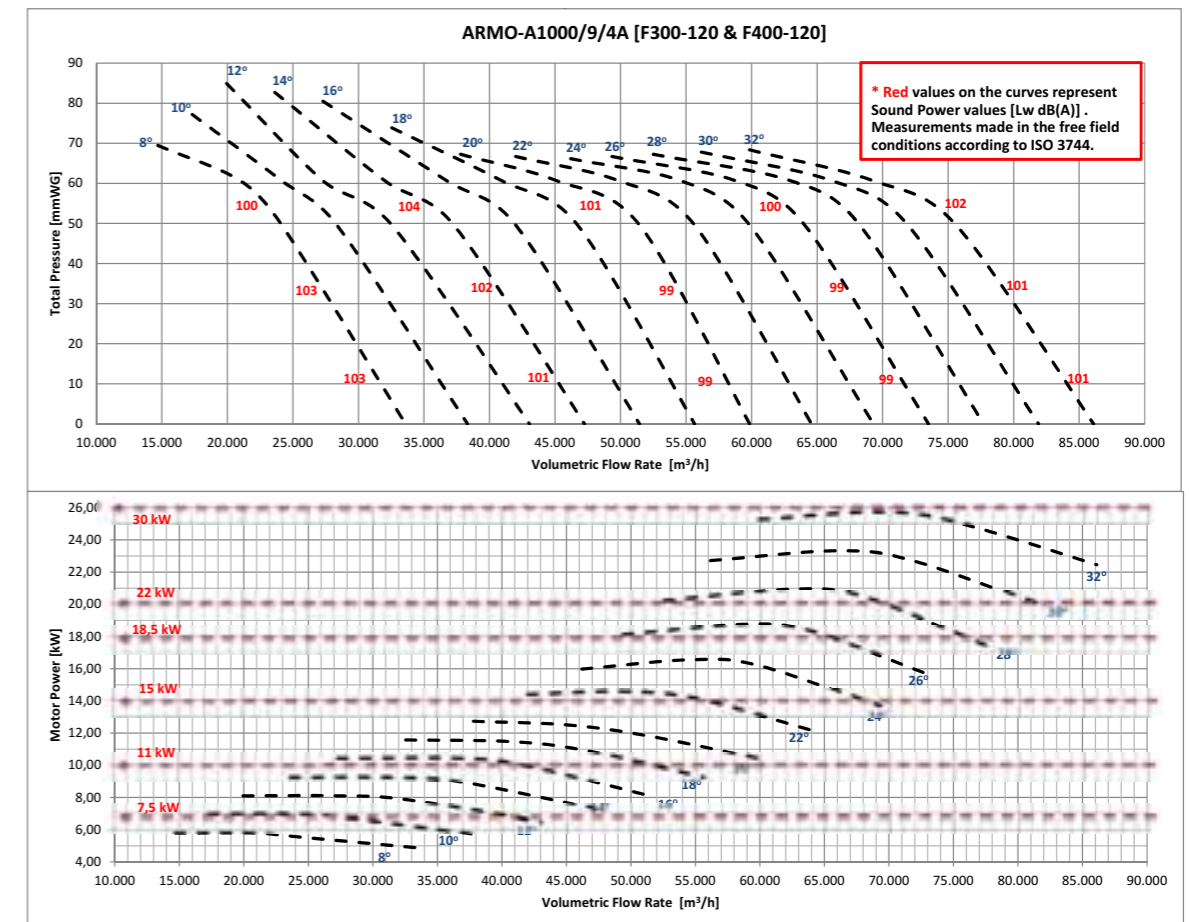
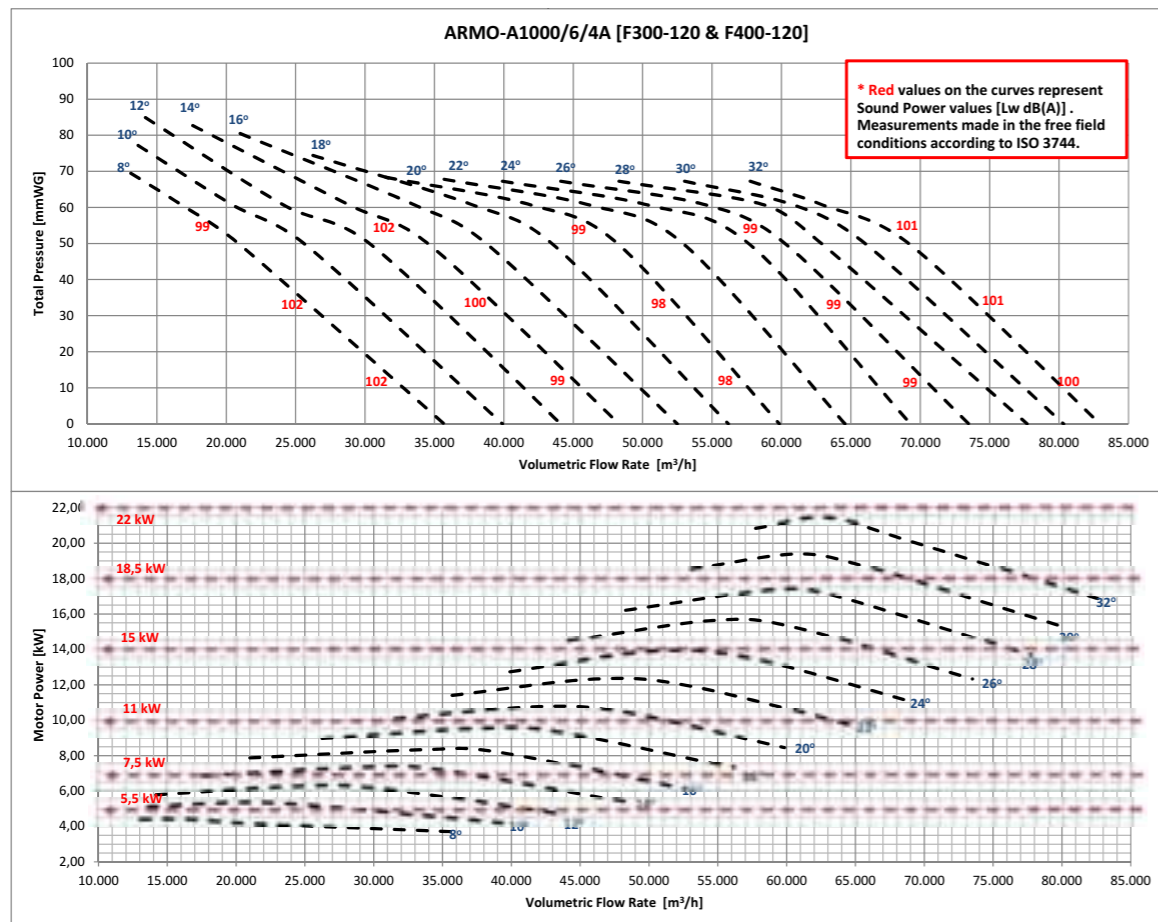
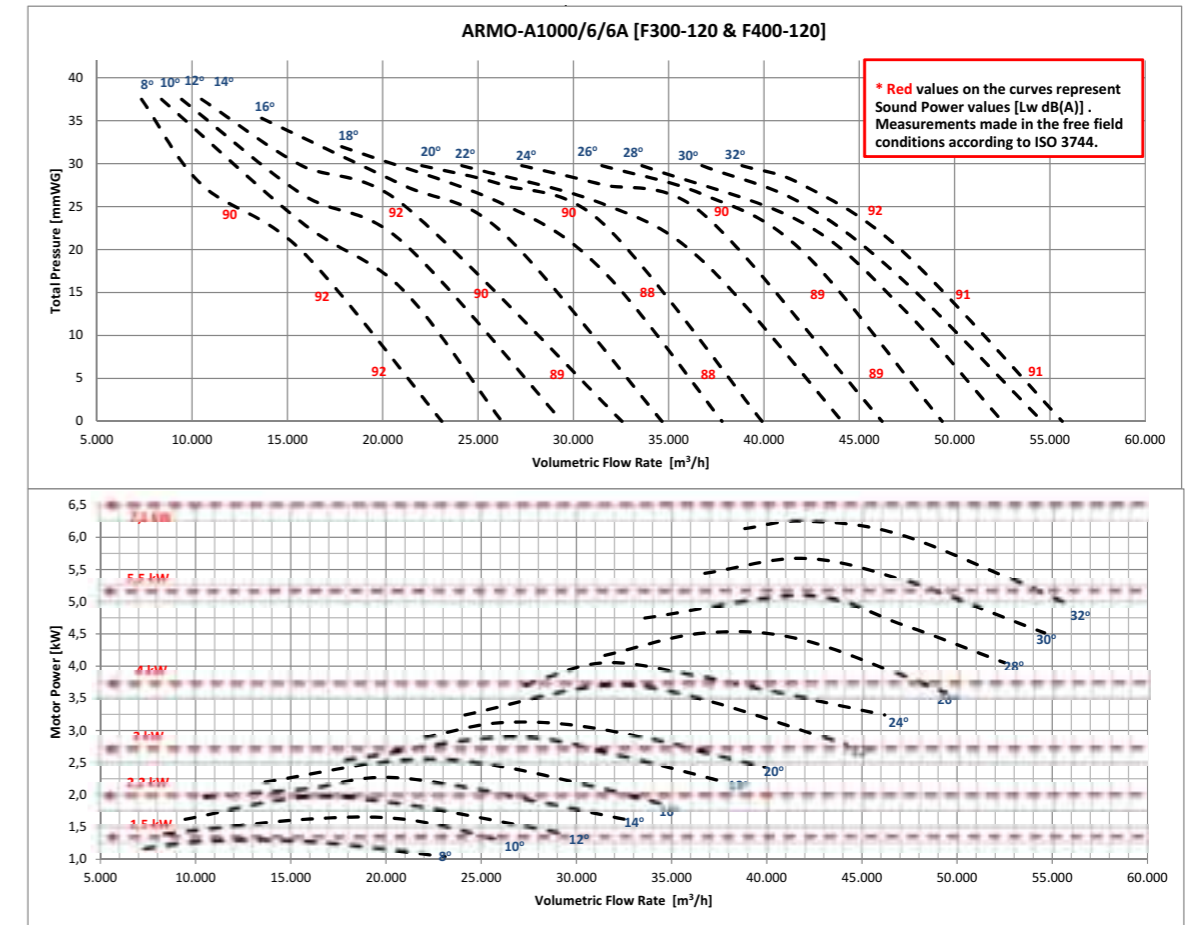
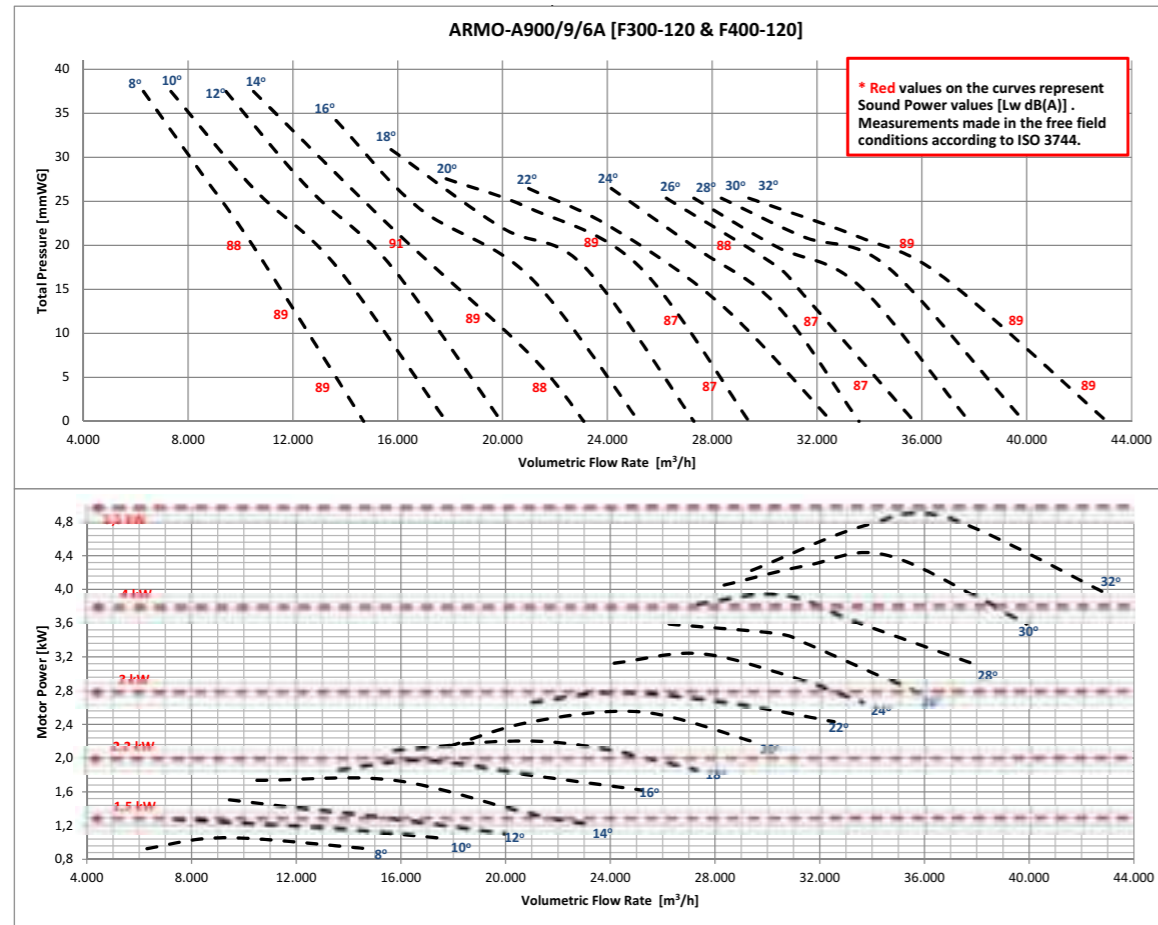

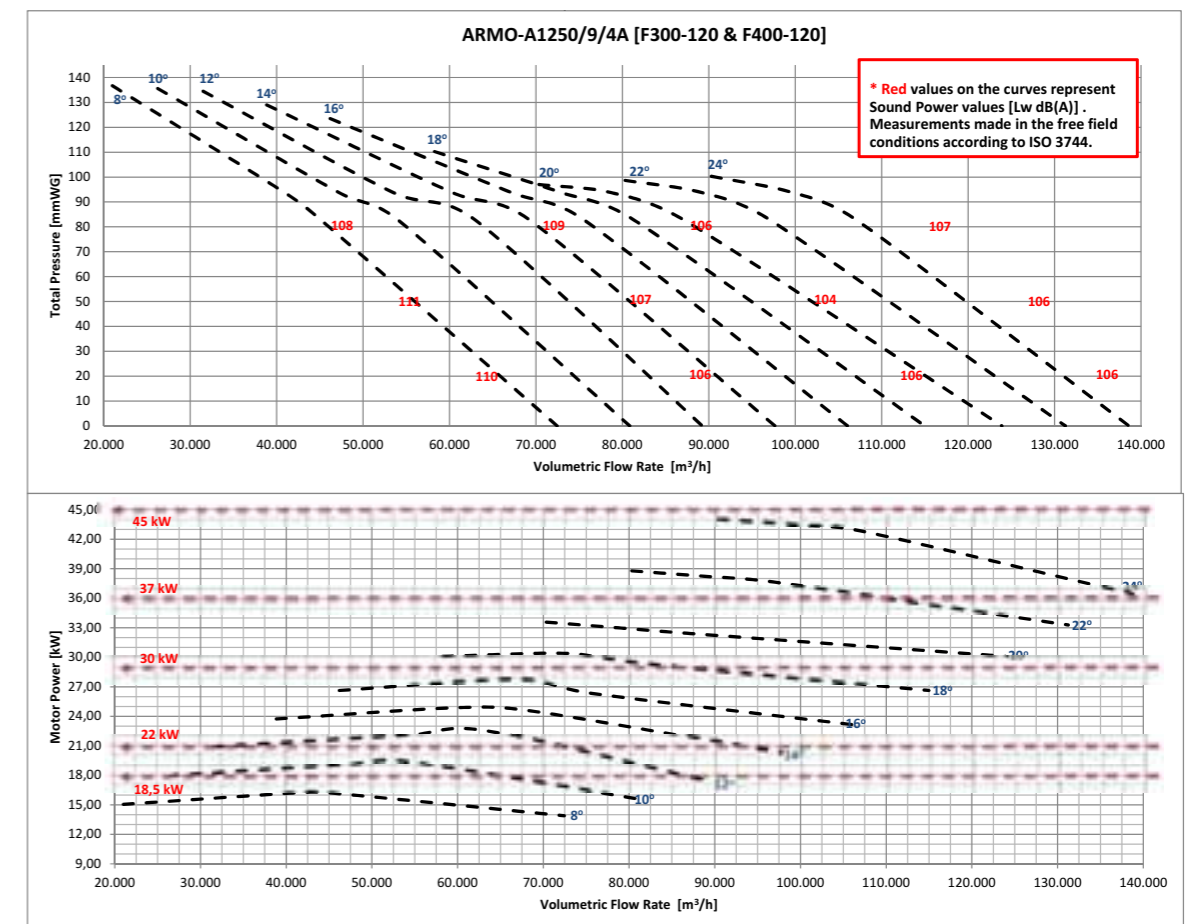
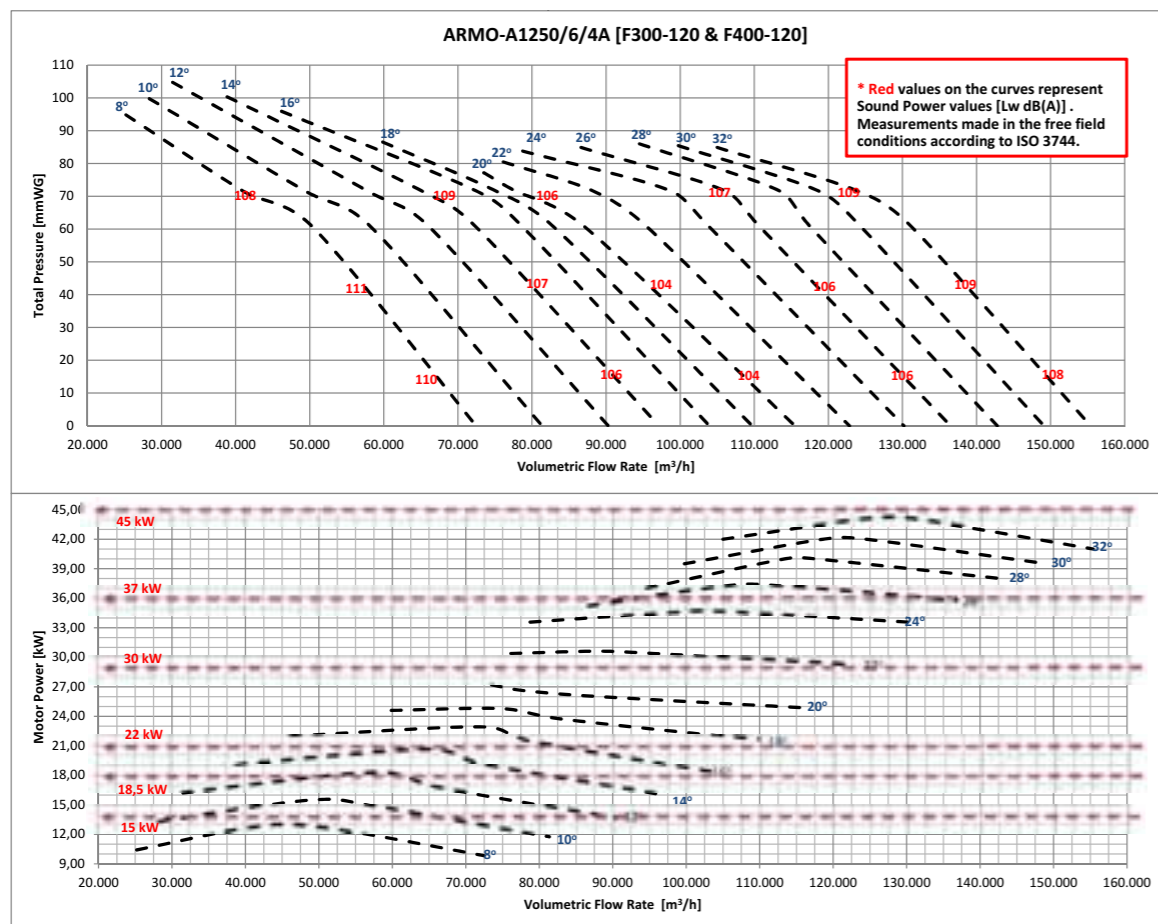
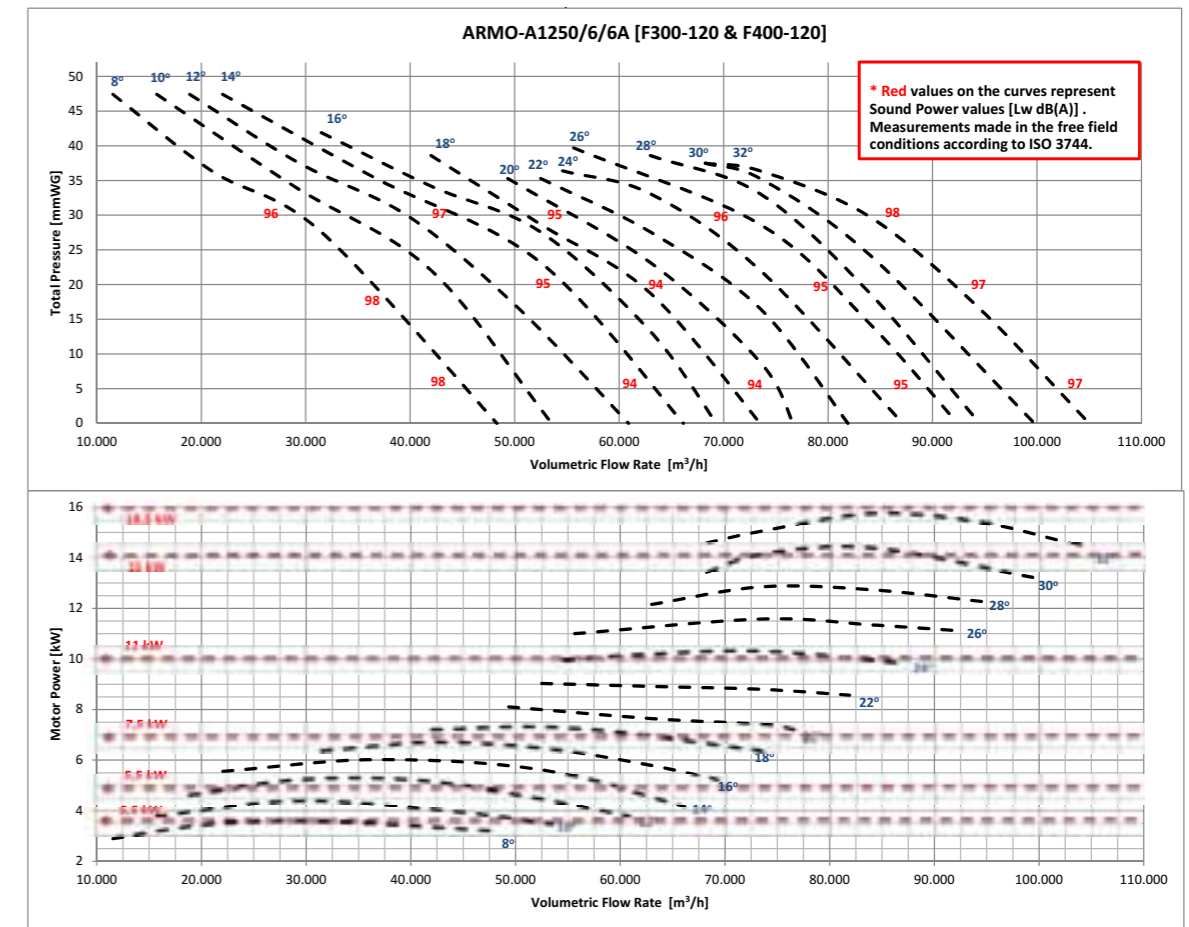
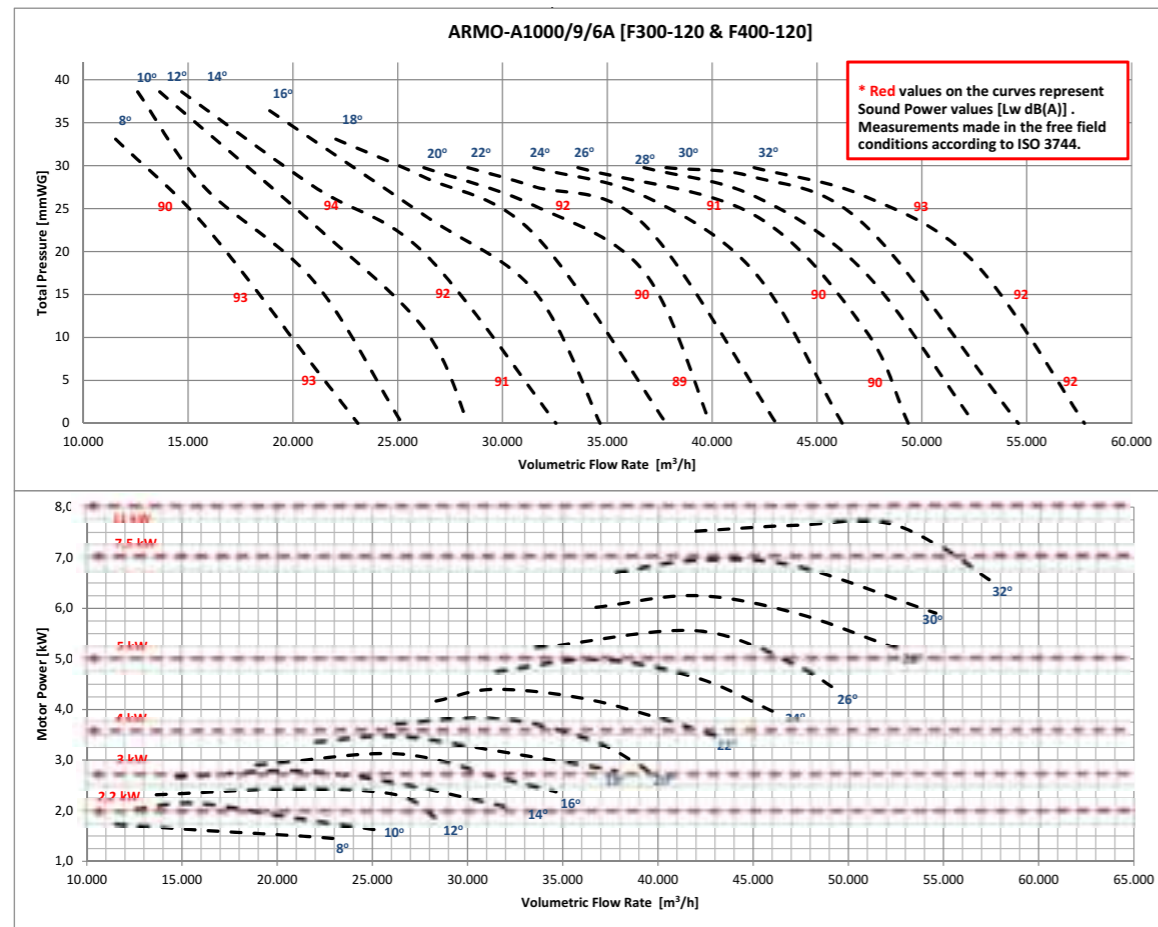

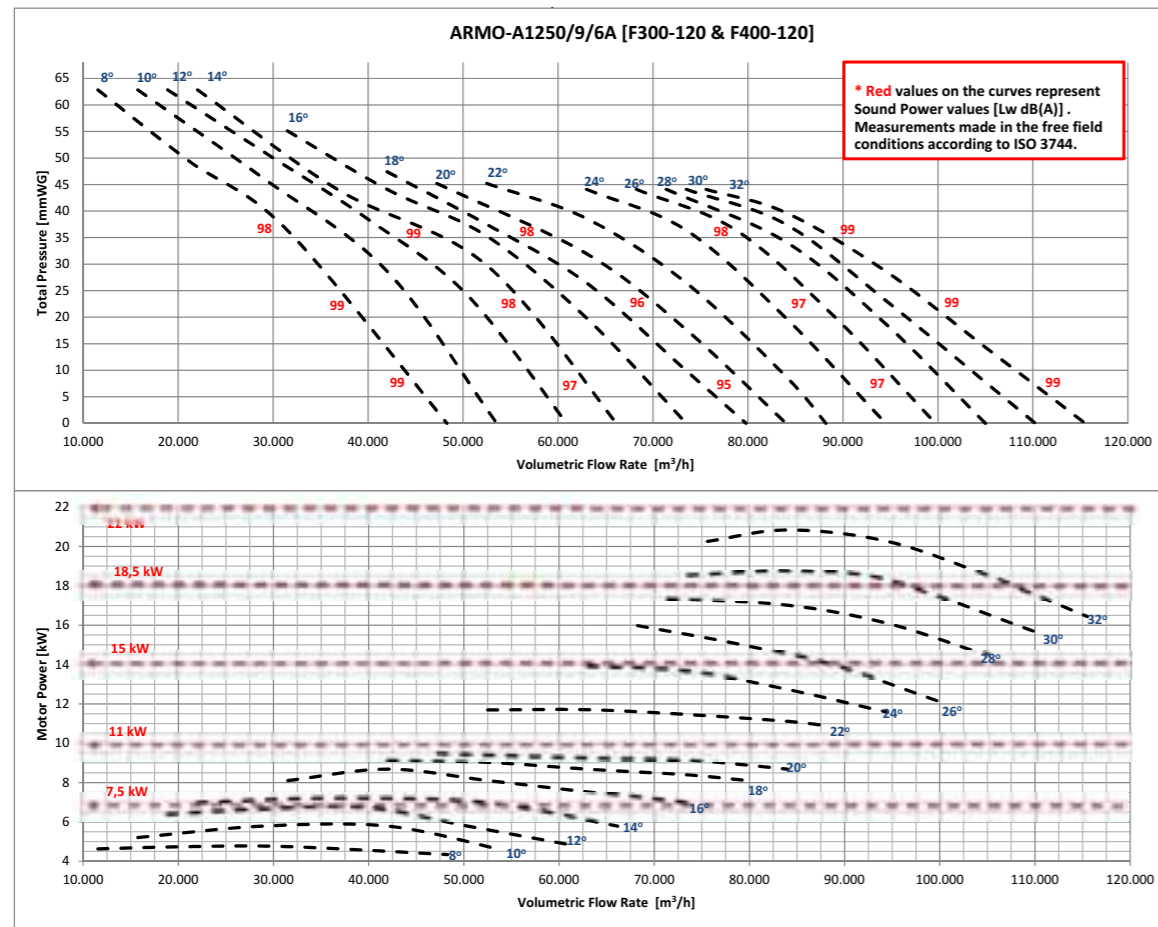



ARMO-C

SMOKE AND HEAT EXHAUST FANS / Cabinet

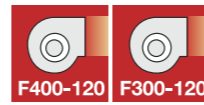

Box Axial fans are used in pressurization fan, fresh air fan and smoke exhaust fan applications. The box is fire resistant and designed according to the noise standard. Smoke evacuation fans are fire resistant.

General Features

- It has EN 12101-3 and Ce certificates.
- 2 hours continuous operation at 400 C and 300C
- There is a wide product range from 400 mm to 1250 mm.

Rotor Features

- Fire resistant aluminum alloy casting blades and fan hub.
- has the ability to work one-way and two-way. The blades are specially designed according to each direction type.
- There is no aerodynamic loss in the case of reversible wing type operation.
- Wings are airfoil and provide high aerodynamic performance in both unidirectional and bidirectional vanes.
- Wing angles are adjustable. In this way, smoke discharge fans can be demanded at different flow rates and pressures.

- The fan part of the fan is dynamically balanced according to ISO 1940 and there is no eccentricity during the operation of the fan.

Body Features

- Fan body is steel sheet. Body is hot dip galvanized and corrosion resistant.
- It has short type body and long type body types.

Motor Features

- Offers 2.4 and 6-pole motors
- The motors are IP 55 class and Class-H insulated.
- All electric motor models are approved for continuous operation (S1) and Emergency operation (S2).

Ease of Maintenance

A maintenance cover is provided to ensure easy maintenance.

Usage Areas

Stair pressurization fan, fresh air fan, smoke is used as exhaust fan.

Technical Drawing and Tables

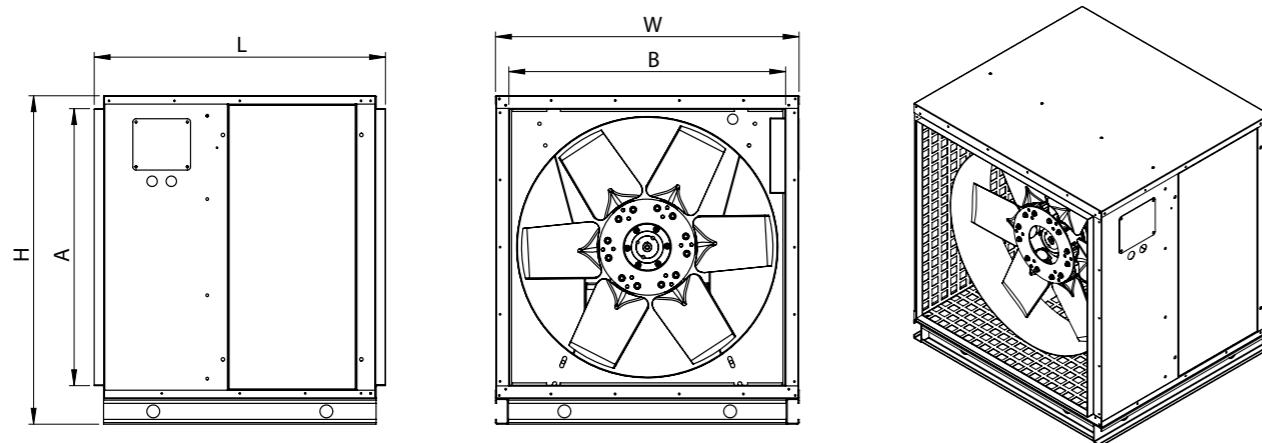

TYPE	L	W	H	A	B
ARMO-C 400	592	568	640	490	490
ARMO-C 450	592	568	640	490	490
ARMO-C 500	592	620	686	536	536
ARMO-C 560	745	707	775	624	624
ARMO-C 630	745	777	845	694	694
ARMO-C 710	910	857	925	774	774
ARMO-C 800	910	950	1025	865	865
ARMO-C 900	1065	1050	1125	965	965
ARMO-C 1000	1065	1150	1250	1069	1069
ARMO-C 1250	1065	1400	1500	1319	1319

Dimensions are in (mm)



2 POLE TYPE	SPEED	DIAMETER	POWER	CURRENT	AIR FLOW	WING ANGLE
	r.p.m	mm	kW	230V - 400V	m ³ /h	
ARMO-C / 400-6 / 0,75 - 2A	2900	400	0,75	1,6	5250	16°
ARMO-C / 400-6 / 1,1 - 2A	2900	400	1,1	2,3	6904	22°
ARMO-C / 400-6 / 1,5 - 2A	2900	400	1,5	3,4	8978	30°
ARMO-C / 400-6 / 2,2 - 2A	2900	400	2,2	4,48	9975	34°
ARMO-C / 450-6 / 1,1 - 2A	2900	450	1,1	2,3	6248	10°
ARMO-C / 450-6 / 1,5 - 2A	2900	450	1,5	3,4	8610	16°
ARMO-C / 450-6 / 2,2 - 2A	2900	450	2,2	4,48	11970	24°
ARMO-C / 450-6 / 3 - 2A	2900	450	3	6	13545	28°
ARMO-C / 500-6 / 2,2 - 2A	2900	500	2,2	4,48	11000	14°
ARMO-C / 500-6 / 3 - 2A	2900	500	3	6	14595	20°
ARMO-C / 500-6 / 4 - 2A	2900	500	4	7,4	17325	26°
ARMO-C / 500-6 / 5,5 - 2A	2900	500	5,5	11	18375	28°
ARMO-C / 560-6 / 4 - 2A	2900	560	4	7,4	17850	14°
ARMO-C / 560-6 / 5,5 - 2A	2900	560	5,5	11	22313	20°
ARMO-C / 560-6 / 7,5 - 2A	2800	560	7,5	13,6	25725	24°
ARMO-C / 630-6 / 5,5 - 2A	2900	630	5,5	11	20475	10°
ARMO-C / 630-6 / 7,5 - 2A	2800	630	7,5	13,6	27300	16°

4 POLE TYPE	SPEED	DIAMETER	POWER	CURRENT	AIR FLOW	WING ANGLE
	r.p.m	mm	kW	230V - 400V	m ³ /h	
ARMO-C / 500-6 / 0,55 - 4A	1415	500	0,55	1,6	8715	26
ARMO-C / 500-6 / 0,75 - 4A	1350	500	0,75	2,1	10290	32
ARMO-C / 500-6 / 1,1 - 4A	1400	500	1,1	2,6	12600	38
ARMO-C / 560-6 / 0,55 - 4A	1415	560	0,55	1,6	9870	16
ARMO-C / 560-6 / 0,75 - 4A	1350	560	0,75	2,1	12075	22
ARMO-C / 560-6 / 1,1 - 4A	1400	560	1,1	2,6	13860	26
ARMO-C / 560-6 / 1,5 - 4A	1405	560	1,5	3,5	15750	32
ARMO-C / 560-6 / 2,2 - 4A	1410	560	2,2	5	17850	38
ARMO-C / 630-6 / 0,75 - 4A	1350	630	0,75	2,1	10605	10
ARMO-C / 630-6 / 1,1 - 4A	1400	630	1,1	2,6	16275	20
ARMO-C / 630-6 / 1,5 - 4A	1405	630	1,5	3,5	18375	24
ARMO-C / 630-6 / 2,2 - 4A	1410	630	2,2	5	21525	30
ARMO-C / 630-6 / 3 - 4A	1410	630	3	6,6	24150	36
ARMO-C / 630-6 / 4 - 4A	1500	630	4	8,2	25200	38
ARMO-C / 710-3 / 0,75 - 4A	1350	710	0,75	2,1	14175	10
ARMO-C / 710-3 / 1,1 - 4A	1400	710	1,1	2,6	18375	16
ARMO-C / 710-3 / 1,5 - 4A	1405	710	1,5	3,5	21000	20
ARMO-C / 710-3 / 2,2 - 4A	1410	710	2,2	5	24413	26
ARMO-C / 710-3 / 3 - 4A	1410	710	3	6,6	27825	32
ARMO-C / 710-6 / 1,1 - 4A	1400	710	1,1	2,6	16275	12
ARMO-C / 710-6 / 1,5 - 4A	1405	710	1,5	3,5	20475	18
ARMO-C / 710-6 / 2,2 - 4A	1410	710	2,2	5	23625	22
ARMO-C / 710-6 / 3 - 4A	1410	710	3	6,6	28350	28
ARMO-C / 710-6 / 4 - 4A	1415	710	4	8,2	31500	32
ARMO-C / 800-6 / 2,2 - 4A	1410	800	2,2	5	24150	14
ARMO-C / 800-6 / 3 - 4A	1410	800	3	6,6	30450	20
ARMO-C / 800-6 / 4 - 4A	1415	800	4	8,2	32550	22
ARMO-C / 800-6 / 5,5 - 4A	1430	800	5,5	11,2	38850	28
ARMO-C / 800-6 / 7,5 - 4A	1440	800	7,5	15,4	42525	32
ARMO-C / 800-9 / 2,2 - 4A	1410	800	2,2	5	16275	10
ARMO-C / 800-9 / 3 - 4A	1410	800	3	6,6	21525	14
ARMO-C / 800-9 / 4 - 4A	1415	800	4	8,2	29400	20
ARMO-C / 800-9 / 5,5 - 4A	1430	800	5,5	11,2	36488	26
ARMO-C / 800-9 / 7,5 - 4A	1440	800	7,5	15,4	40950	30
ARMO-C / 800-9 / 11 - 4A	1450	800	11	21	43050	32
ARMO-C / 900-6 / 4 - 4A	1415	900	4	8,2	31500	12
ARMO-C / 900-6 / 5,5 - 4A	1430	900	5,5	11,2	38850	16
ARMO-C / 900-6 / 7,5 - 4A	1440	900	7,5	15,4	47775	22
ARMO-C / 900-6 / 11 - 4A	1450	900	11	21	56700	28
ARMO-C / 900-6 / 15 - 4A	1450	900	15	29,3	60900	32
ARMO-C / 900-9 / 4 - 4A	1415	900	4	8,2	26775	10
ARMO-C / 900-9 / 5,5 - 4A	1430	900	5,5	11,2	34125	14
ARMO-C / 900-9 / 7,5 - 4A	1440	900	7,5	15,4	41213	18
ARMO-C / 900-9 / 11 - 4A	1450	900	11	21	54600	26
ARMO-C / 900-9 / 15 - 4A	1450	900	15	29,3	63525	32
ARMO-C / 1000-6 / 5,5 - 4A	1430	1000	5,5	11,2	38850	12
ARMO-C / 1000-6 / 7,5 - 4A	1440	1000	7,5	15,4	47775	18
ARMO-C / 1000-6 / 11 - 4A	1450	1000	11	21	56700	22
ARMO-C / 1000-6 / 15 - 4A	1450	1000	15	29,3	60900	28
ARMO-C / 1000-6 / 18,5 - 4A	1455	1000	18,5	34,5	56700	32
ARMO-C / 1000-9 / 7,5 - 4A	1440	1000	7,5	15,4	43050	12
ARMO-C / 1000-9 / 11 - 4A	1450	1000	11	21	55650	18
ARMO-C / 1000-9 / 15 - 4A	1450	1000	15	29,3	69300	24
ARMO-C / 1000-9 / 18,5 - 4A	1455	1000	18,5	34,5	77700	28
ARMO-C / 1000-9 / 22 - 4A	1460	1000	22	42,5	81900	30
ARMO-C / 1000-9 / 30 - 4A	1460	1000	30	55	86100	32
ARMO-C / 1250-6 / 15 - 4A	1450	1250	15	29,3	90300	12
ARMO-C / 1250-6 / 18,5 - 4A	1455	1250	18,5	34,5	103950	16
ARMO-C / 1250-6 / 22 - 4A	1460	1250	22	42,5	109725	18
ARMO-C / 1250-6 / 30 - 4A	1460	1250	30	55	122850	22
ARMO-C / 1250-6 / 37 - 4A	1470	1250	37	67	136500	26
ARMO-C / 1250-6 / 45 - 4A	1475	1250	45	80	155400	32
ARMO-C / 1250-9 / 18,5 - 4A	1455	1250	18,5	34,5	89250	12
ARMO-C / 1250-9 / 22 - 4A	1460	1250	22	42,5	97650	14
ARMO-C / 1250-9 / 30 - 4A	1460	1250	30	55	114975	18
ARMO-C / 1250-9 / 37 - 4A	1470	1250	37	67	131250	22
ARMO-C / 1250-9 / 45 - 4A	1475	1250	45	80	138600	24

6 POLE TYPE	SPEED	DIAMETER	POWER	CURRENT	AIR FLOW	WING ANGLE
	r.p.m	mm	kW	230V - 400V	m ³ /h	
ARMO-C / 500-6 / 0,37 - 6A	900	500	0,37	1,1	8400	38
ARMO-C / 560-6 / 0,37 - 6A	900	560	0,37	1,1	10500	32
ARMO-C / 560-6 / 0,55 - 6A	930	560	0,55	1,5	11760	38
ARMO-C / 630-6 / 0,37 - 6A	900	630	0,37	1,1	11576	22
ARMO-C / 630-6 / 0,55 - 6A	930	630	0,55	1,5	13650	28
ARMO-C / 630-6 / 0,75 - 6A	945	630	0,75	2	14963	32
ARMO-C / 630-6 / 1,1 - 6A	945	630	1,1	2,9	16800	38
ARMO-C / 710-3 / 0,37 - 6A	900	710	0,37	1,1	13125	18
ARMO-C / 710-3 / 0,55 - 6A	930	710	0,55	1,5	16538	26
ARMO-C / 710-3 / 0,75 - 6A	945	710	0,75	2	18900	32
ARMO-C / 710-6 / 1,1 - 6A	945	710	1,1	2,9	11025	12
ARMO-C / 710-6 / 1,5 - 6A	945	710	1,5	3,6	13000	16
ARMO-C / 710-6 / 2,2 - 6A	950	710	2,2	5,4	13750	22
ARMO-C / 710-6 / 3 - 6A	950	710	3	6,9	18900	28
ARMO-C / 710-6 / 4 - 6A	955	710	4	9	21000	32
ARMO-C / 800-6 / 0,55 - 6A	930	800	0,55		13125	10
ARMO-C / 800-6 / 1,1 - 6A	945	800	1,1	2,9	22050	22
ARMO-C / 800-6 / 1,5 - 6A	945	800	1,5	3,6	25200	26
ARMO-C / 800-6 / 2,2 - 6A	950	800	2,2	5,4	28350	32
ARMO-C / 800-9 / 0,75 - 6A	945	800	0,75	2	14700	14
ARMO-C / 800-9 / 1,1 - 6A	945	800	1,1	2,9	19950	20
ARMO-C / 800-9 / 1,5 - 6A	945	800	1,5	3,6	23100	24
ARMO-C / 800-9 / 2,2 - 6A	950	800	2,2	5,4	27300	30
ARMO-C / 800-9 / 3 - 6A	950	800	3	6,9	28350	32
ARMO-C / 900-6 / 1,1 - 6A	945	900	1,1	2,9	23100	14
ARMO-C / 900-6 / 1,5 - 6A	945	900	1,5	3,6	25200	16
ARMO-C / 900-6 / 2,2 - 6A	950	900	2,2	5,4	31500	22
ARMO-C / 900-6 / 3 - 6A	950	900	3	6,9	36750	28
ARMO-C / 900-6 / 4 - 6A	955	900	4	9	40950	32
ARMO-C / 900-9 / 1,5 - 6A	945	900	1,5	3,6	23100	14
ARMO-C / 900-9 / 2,2 - 6A	950	900	2,2	5,4	27300	20
ARMO-C / 900-9 / 3 - 6A	950	900	3	6,9	35700	24
ARMO-C / 900-9 / 4 - 6A	955	900	4	9	39900	30
ARMO-C / 900-9 / 5,5 - 6A	985	900	5,5	12,3	43050	32
ARMO-C / 1000-6 / 1,5 - 6A	945	1000	1,5	3,6	26250	10
ARMO-C / 1000-6 / 2,2 - 6A	950	1000	2,2	5,4	34650	16
ARMO-C / 1000-6 / 3 - 6A	950	1000	3	6,9	44100	22
ARMO-C / 1000-6 / 4 - 6A	955	1000	4	9	49350	26
ARMO-C / 1000-6 / 5,5 - 6A	985	1000	5,5	12,3	55650	32
ARMO-C / 1000-9 / 2,2 - 6A	950	1000	2,2	5,4	32550	14
ARMO-C / 1000-9 / 3 - 6A	950	1000	3	6,9	39900	20
ARMO-C / 1000-9 / 4 - 6A	955	1000	4	9	43050	22
ARMO-C / 1000-9 / 5,5 - 6A	985	1000	5,5	12,3	52500	28
ARMO-C / 1000-9 / 7,5 - 6A	960	1000	7,5	15	57750	32
ARMO-C / 1250-6 / 4 - 6A	955	1250	4	9	60900	12
ARMO-C / 1250-6 / 5,5 - 6A	985	1250	5,5	12,3	63300	16
ARMO-C / 1250-6 / 7,5 - 6A	960	1250	7,5	15	76650	20
ARMO-C / 1250-6 / 11 - 6A	960	1250	11	22	92400	26
ARMO-C / 1250-6 / 15 - 6A	965	1250	15	29	105000	32
ARMO-C / 1250-9 / 7,5 - 6A	960	1250	7,5	15	73500	16
ARMO-C / 1250-9 / 11 - 6A	960	1250	11	22	88200	22
ARMO-C / 1250-9 / 15 - 6A	965	1250	15	29	105000	28
ARMO-C / 1250-9 / 18,5 - 6A	970	1250	18,5	36,5	115500	32

Accessories



BSC-F BDEB BDH BDKS BFG2 BFG3 BFG4 BFH13 BTY BBDD

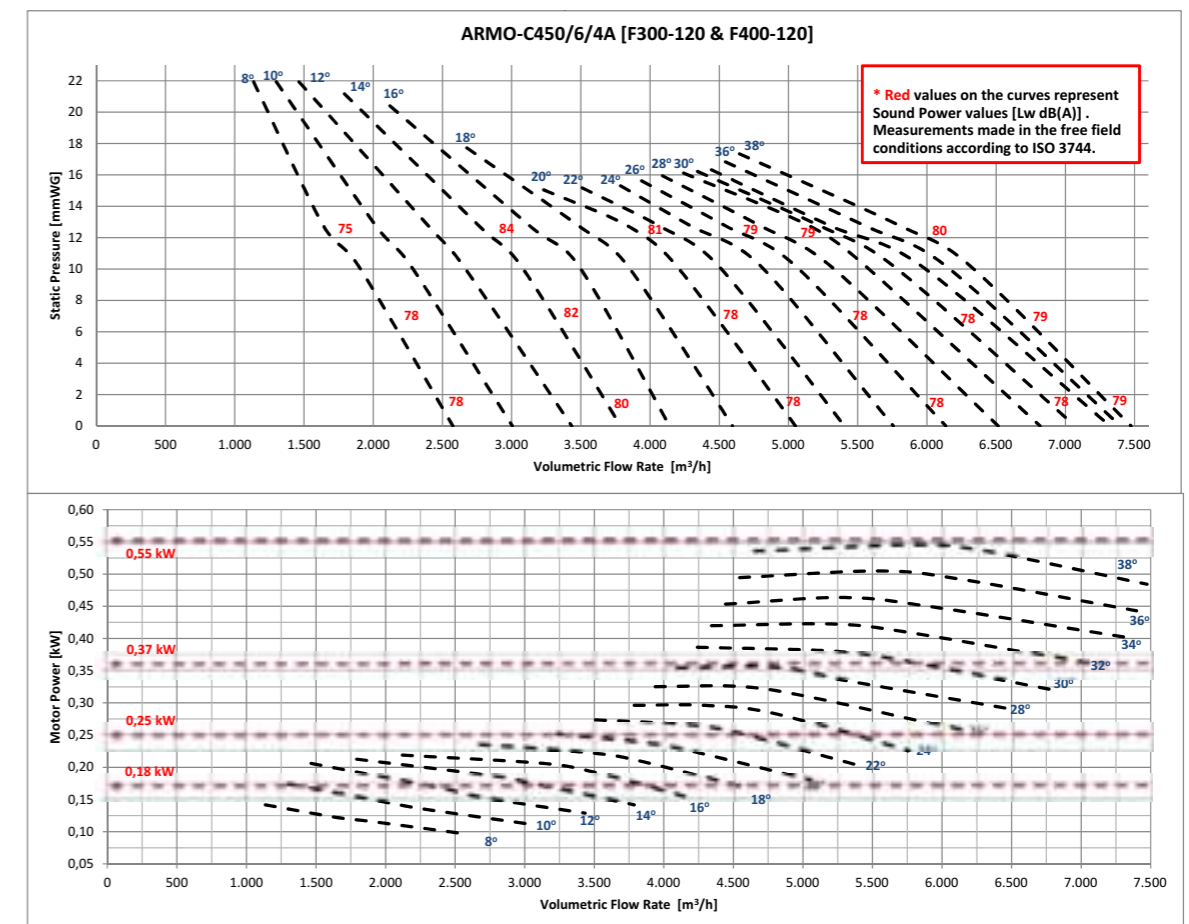
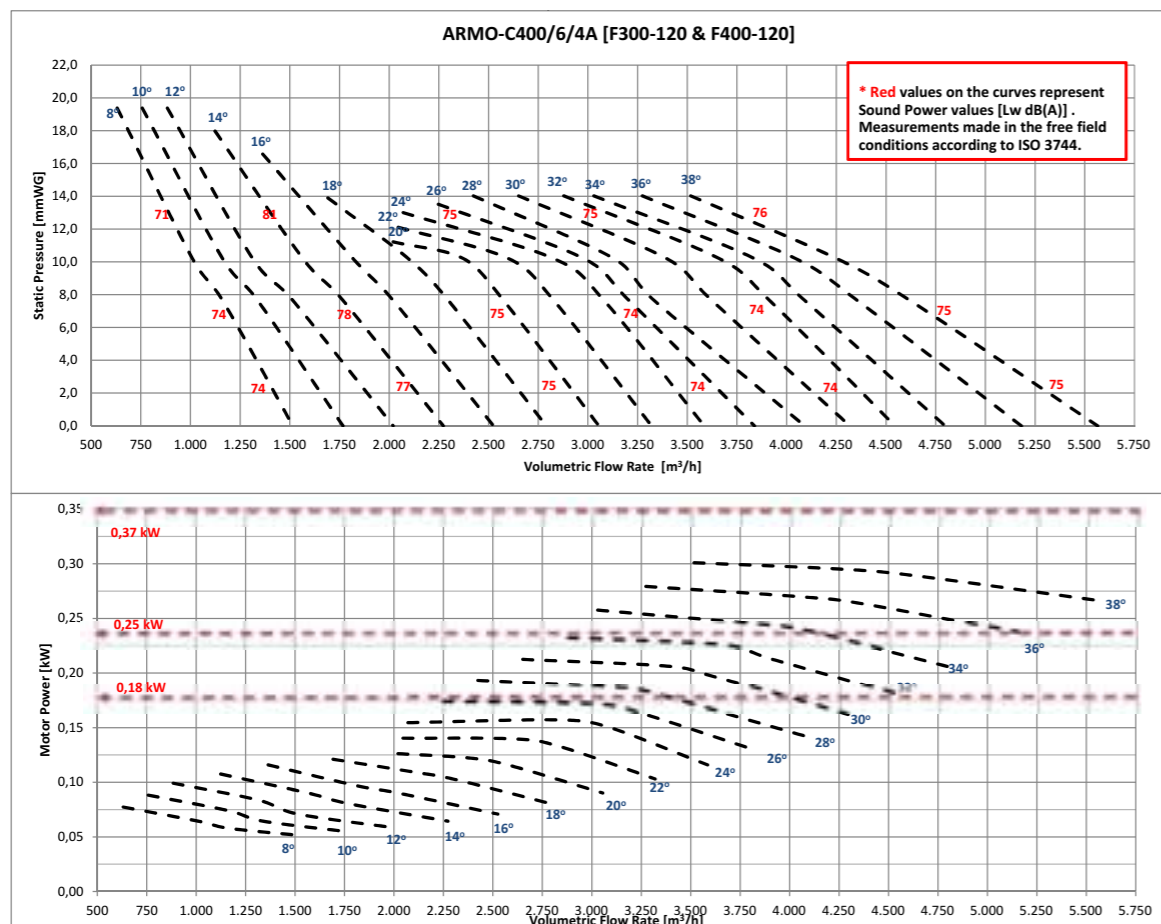
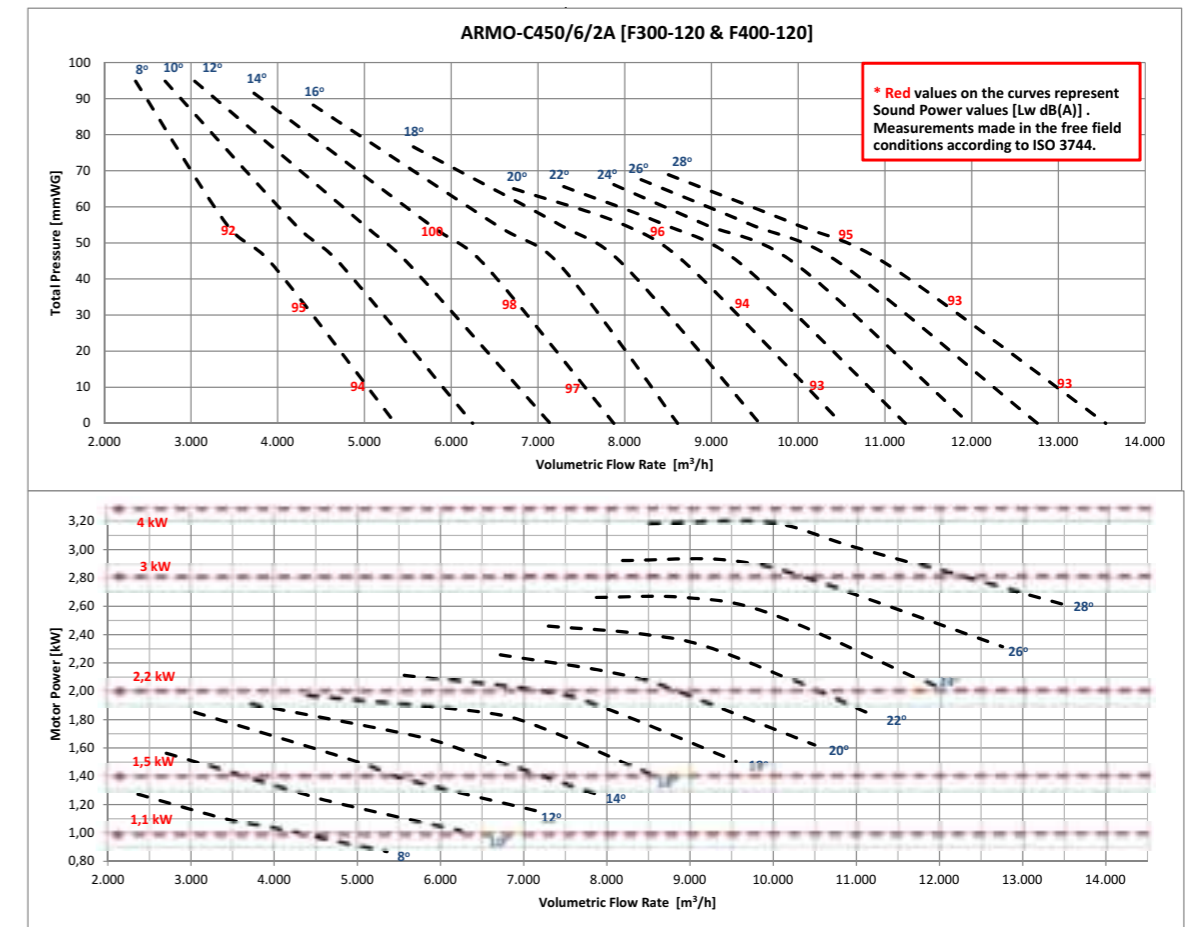
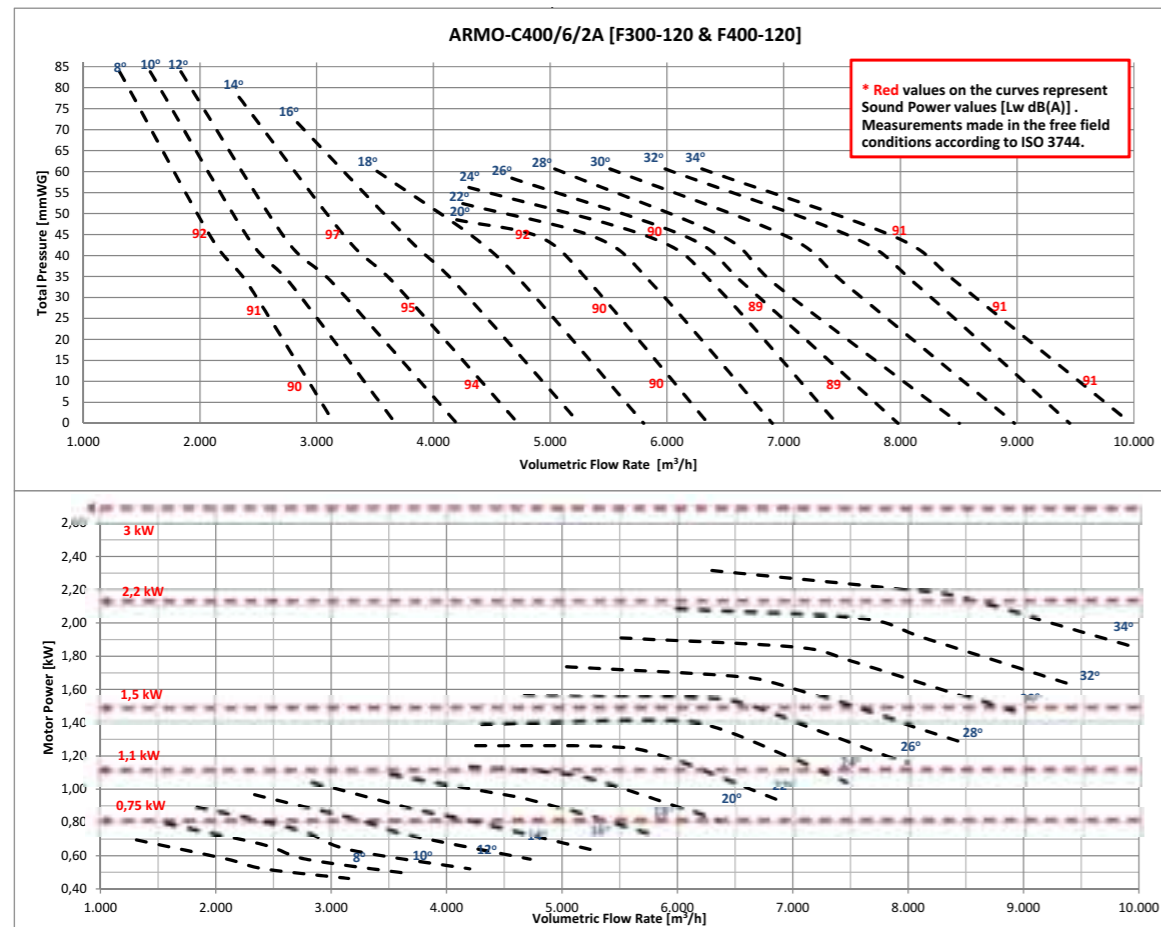

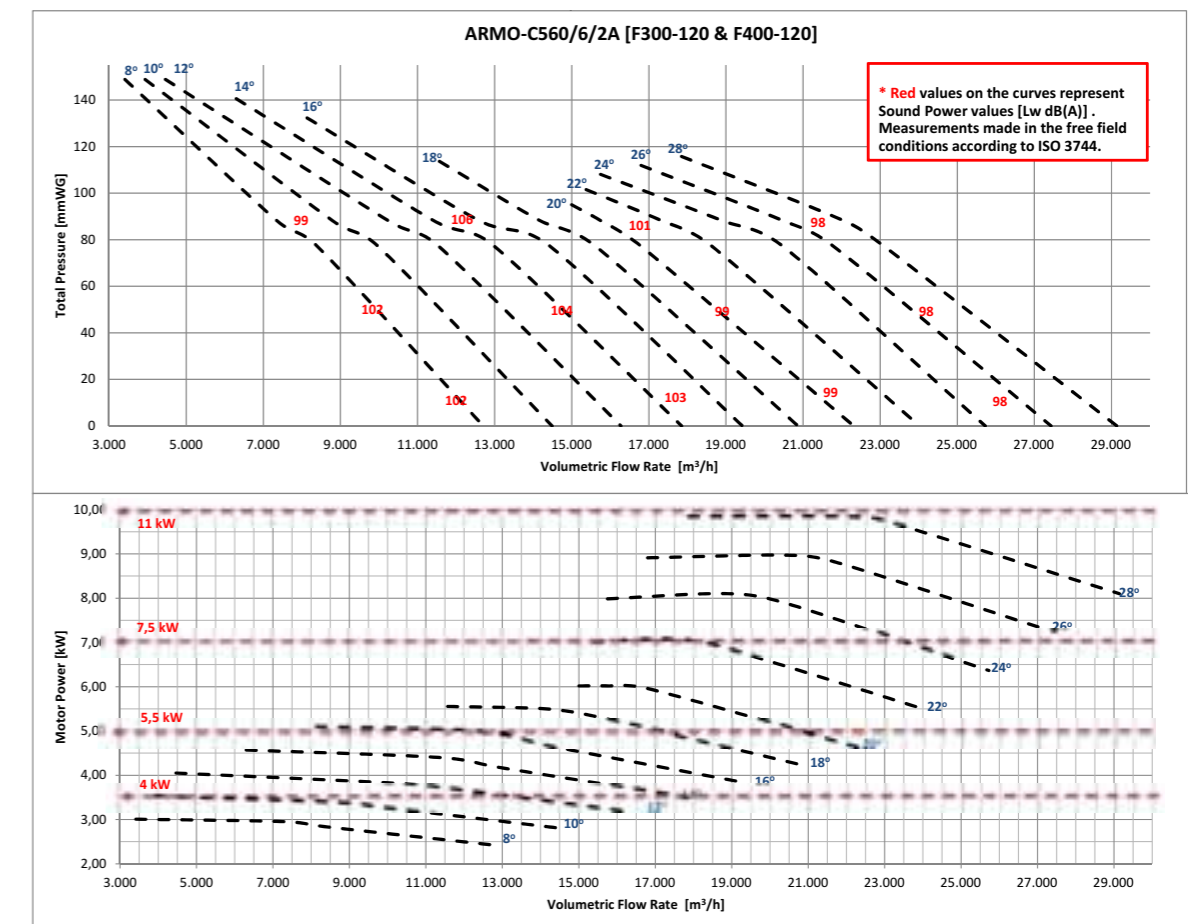
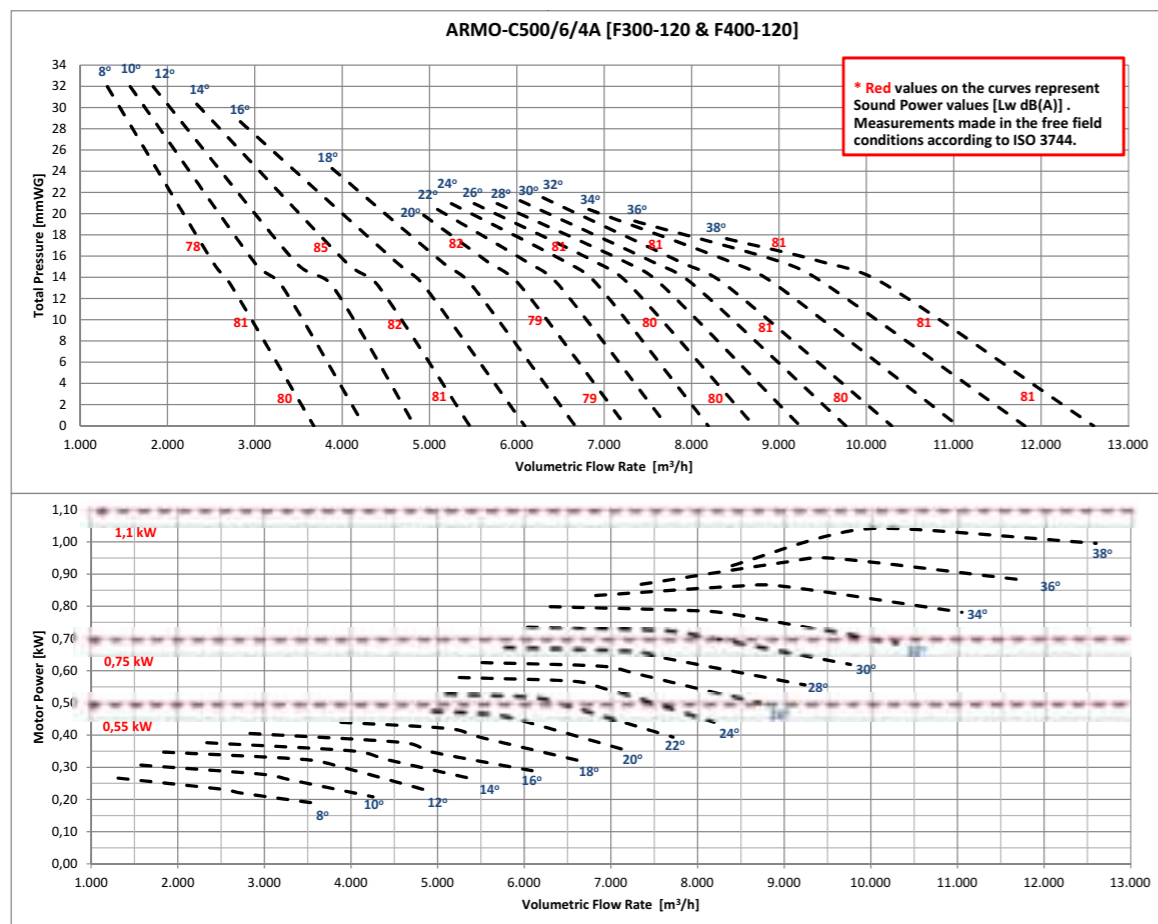
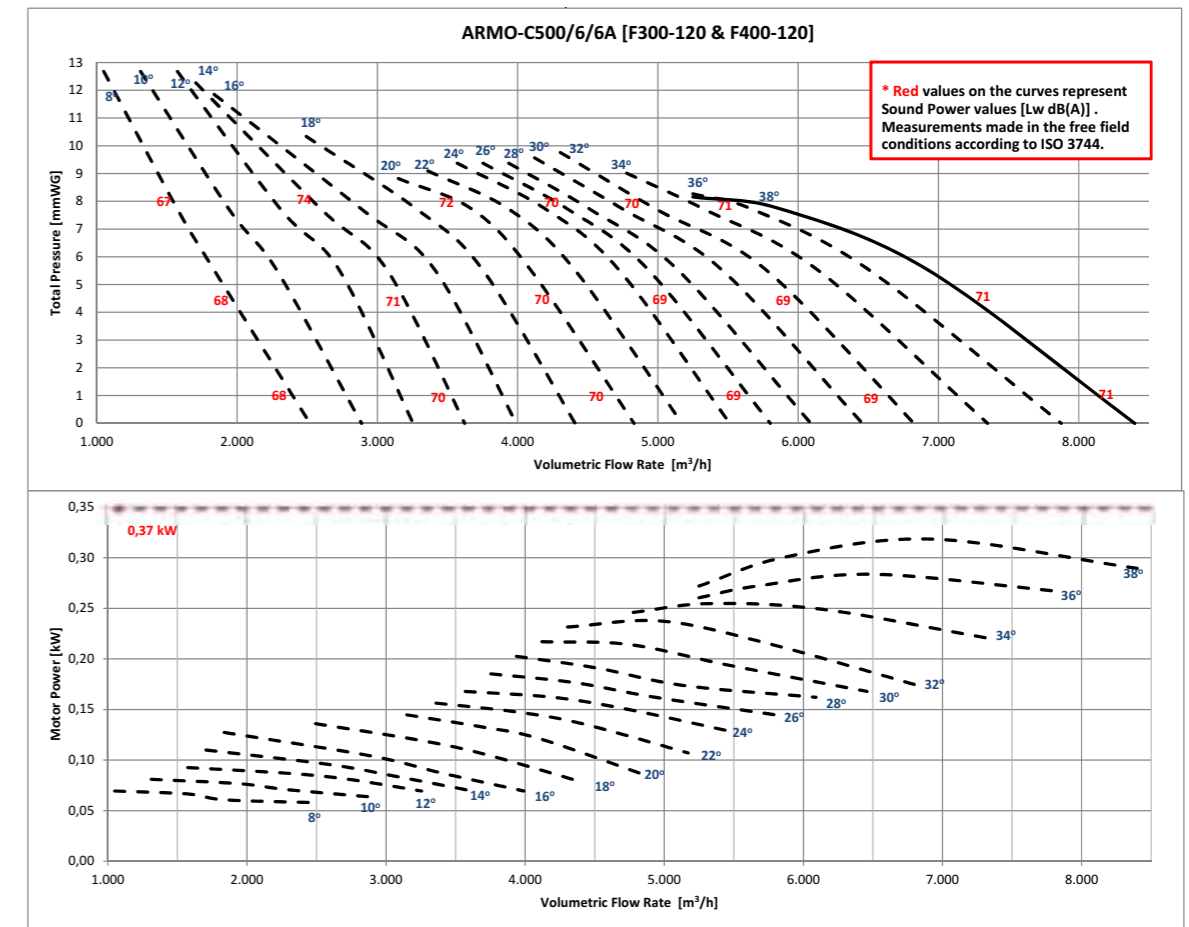
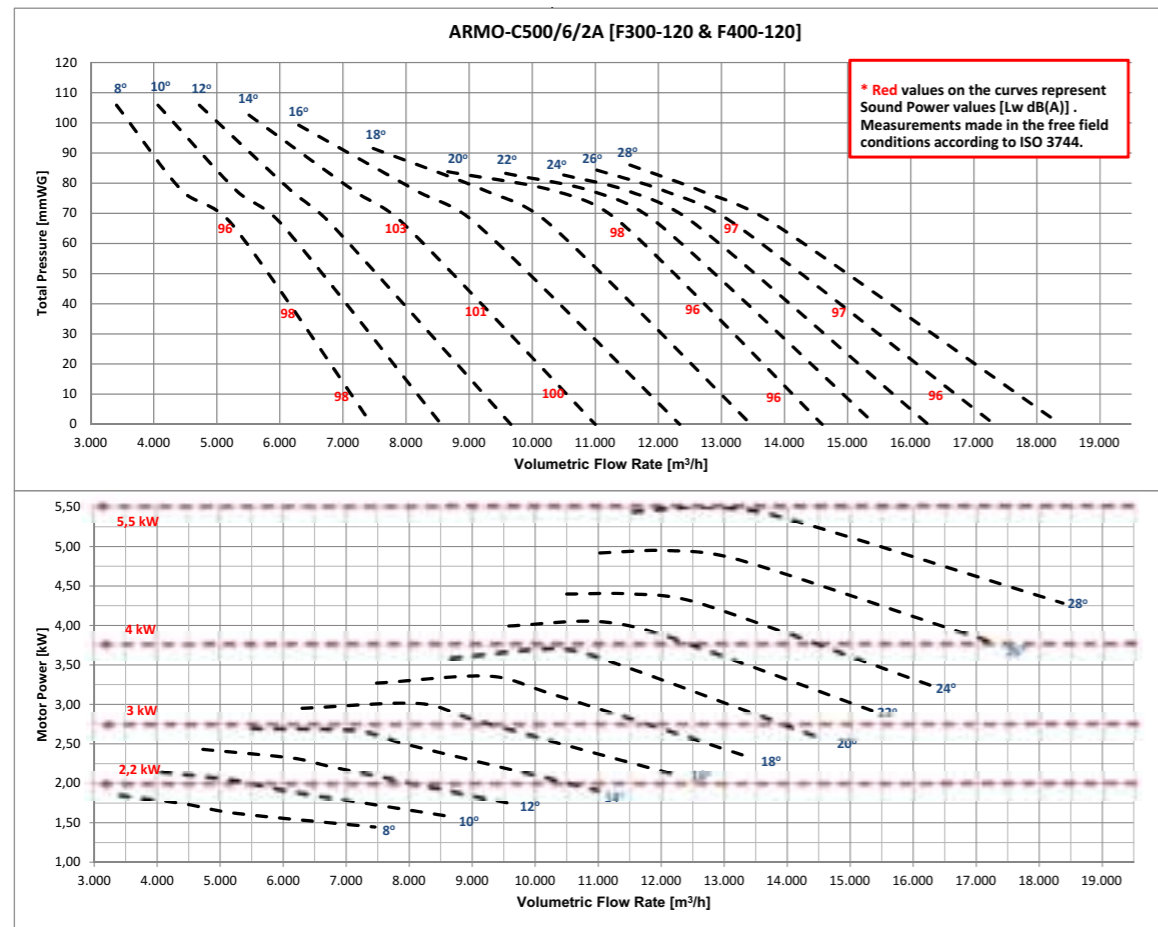

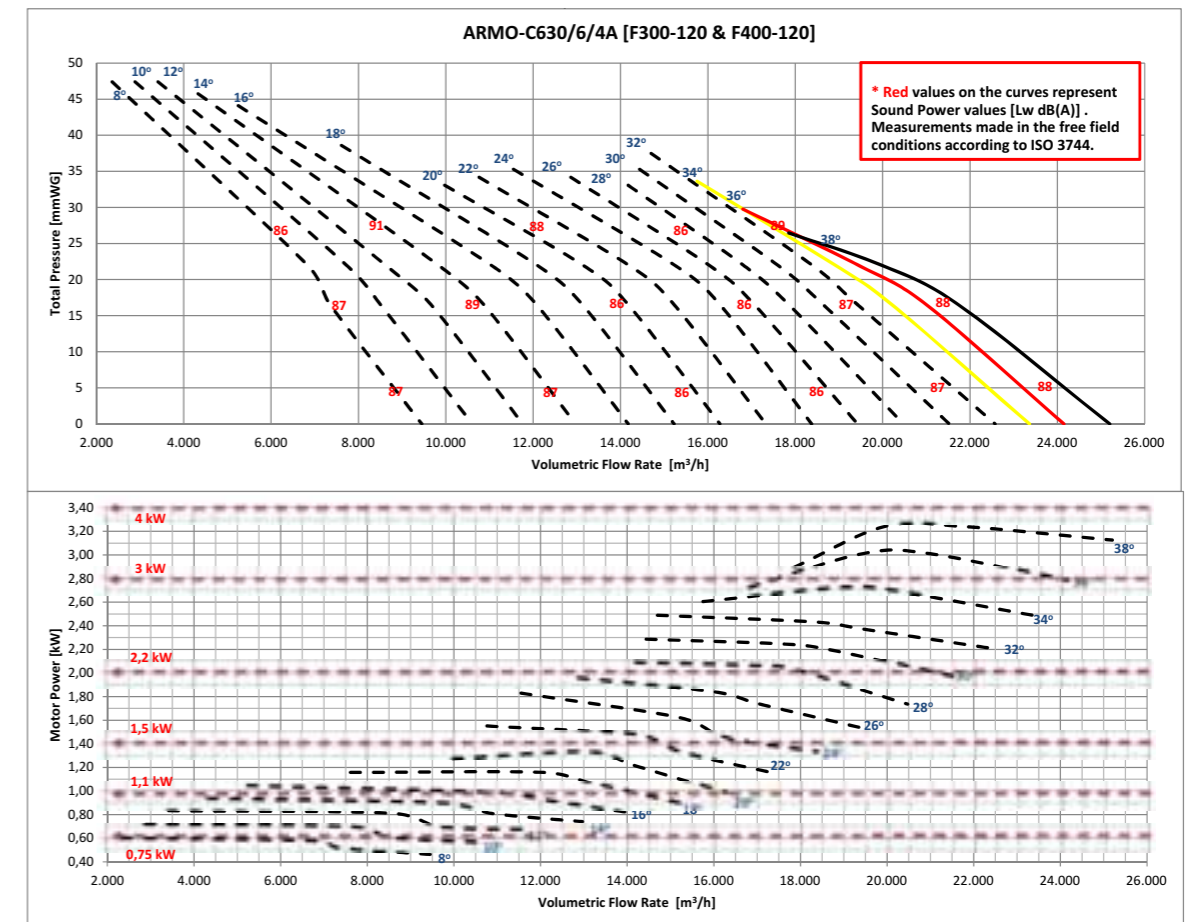
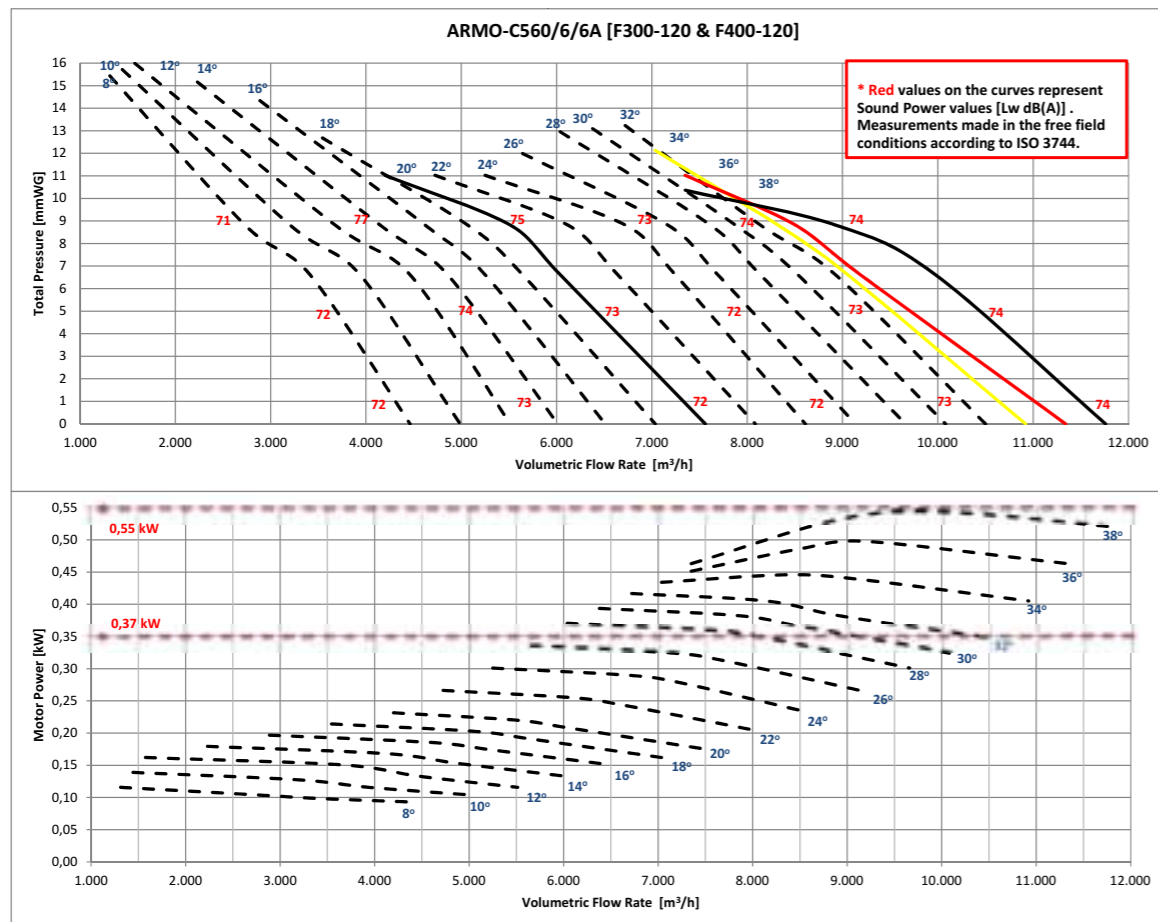
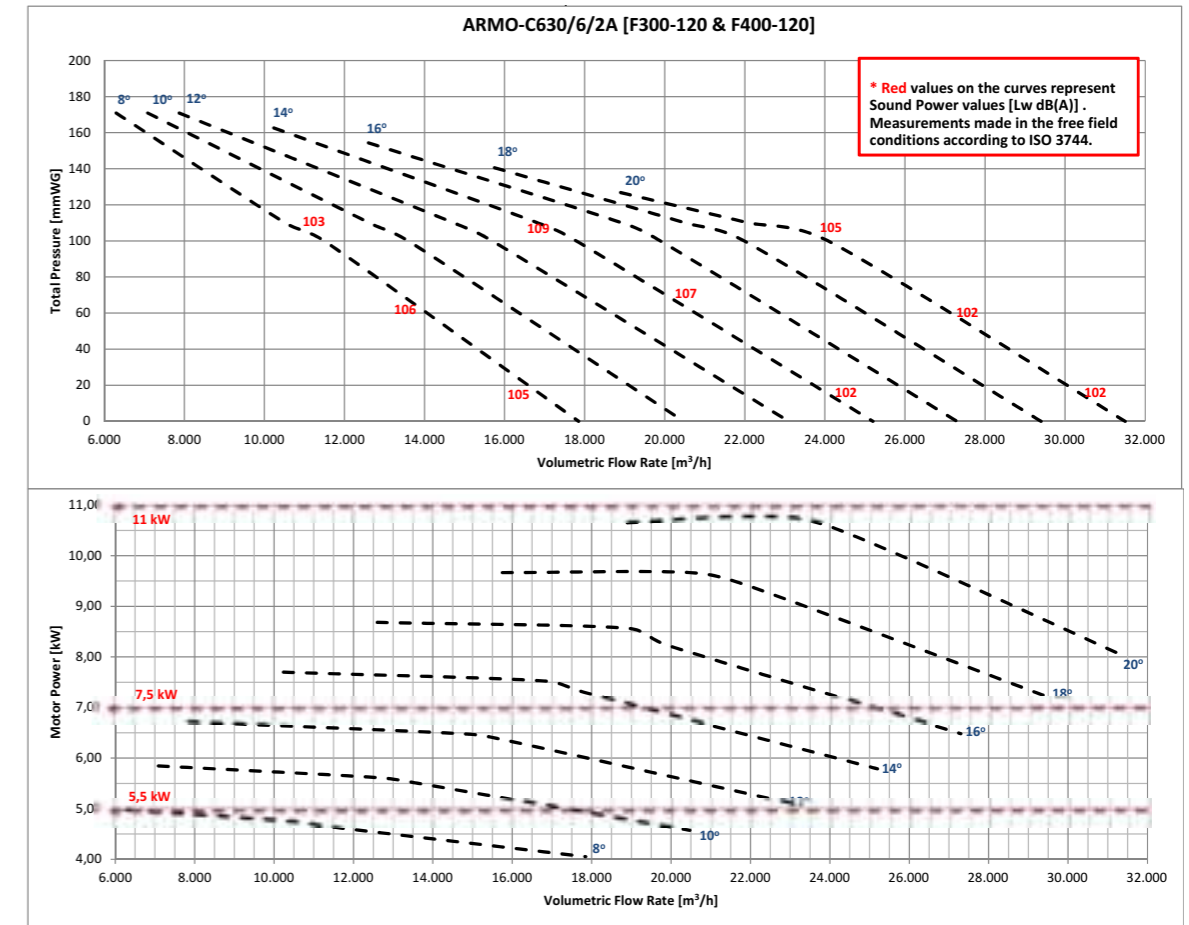
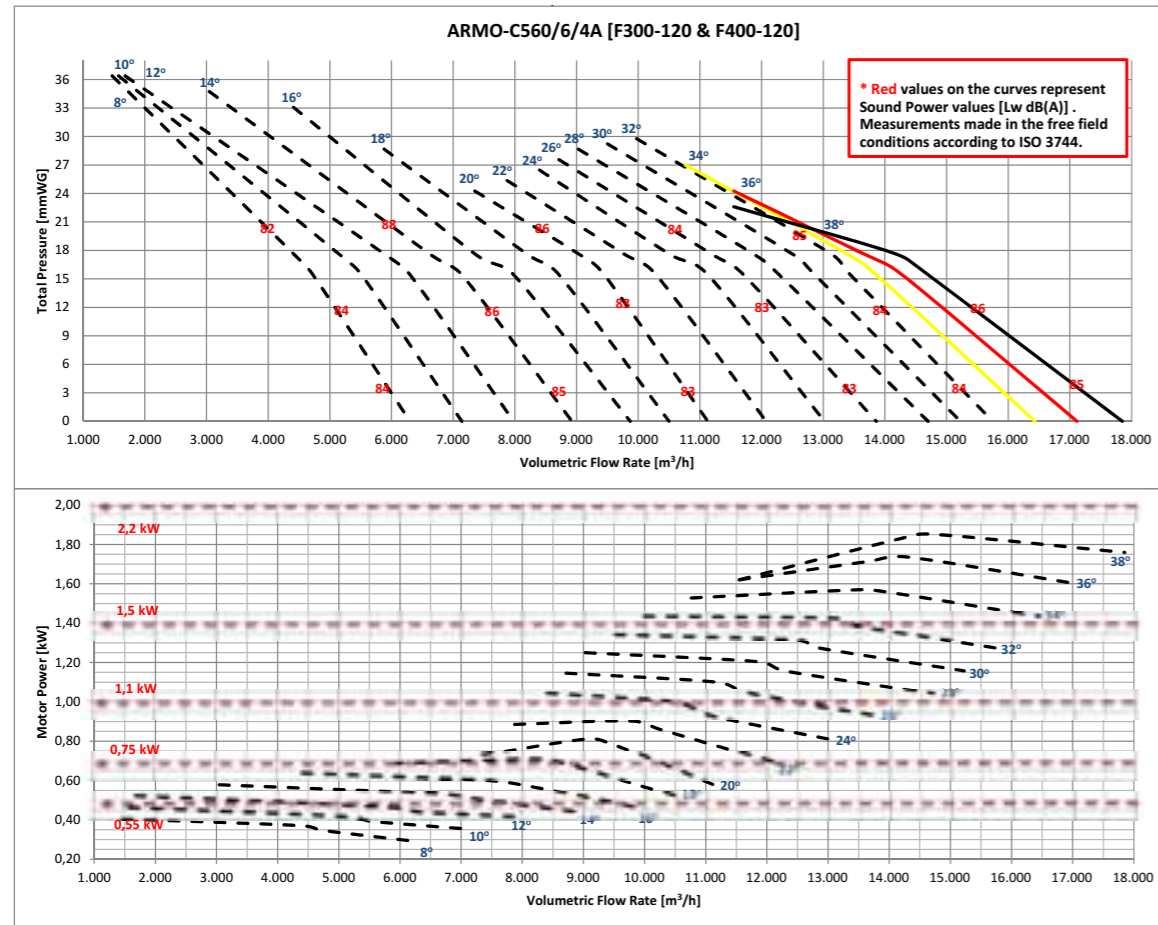

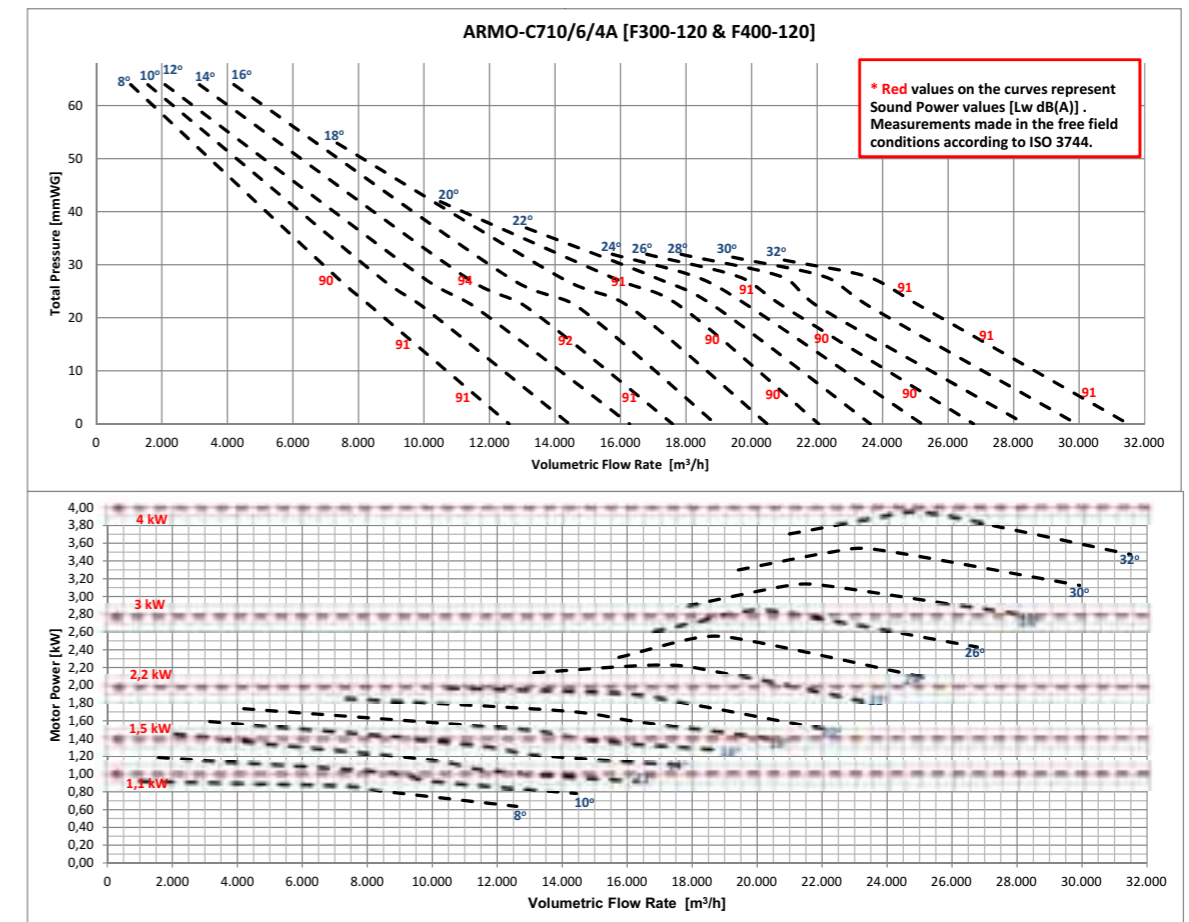
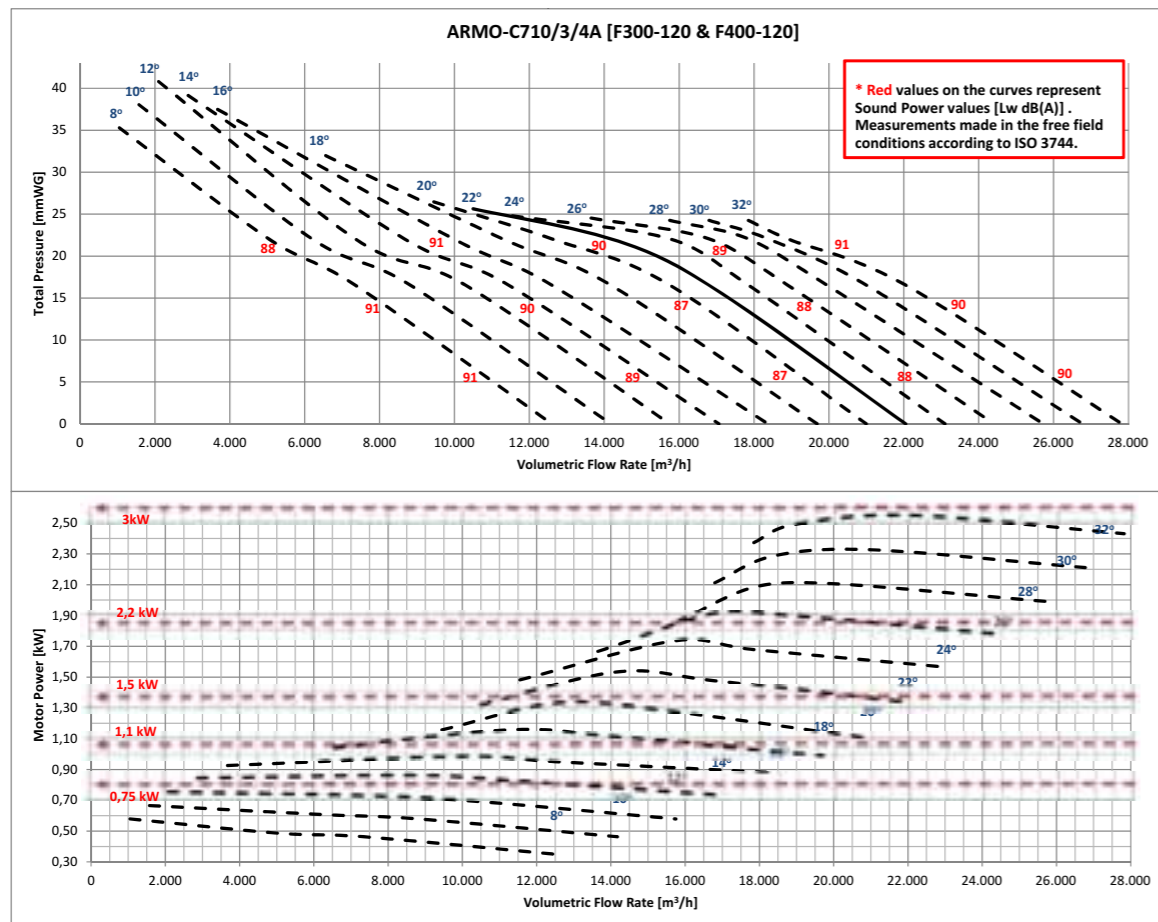
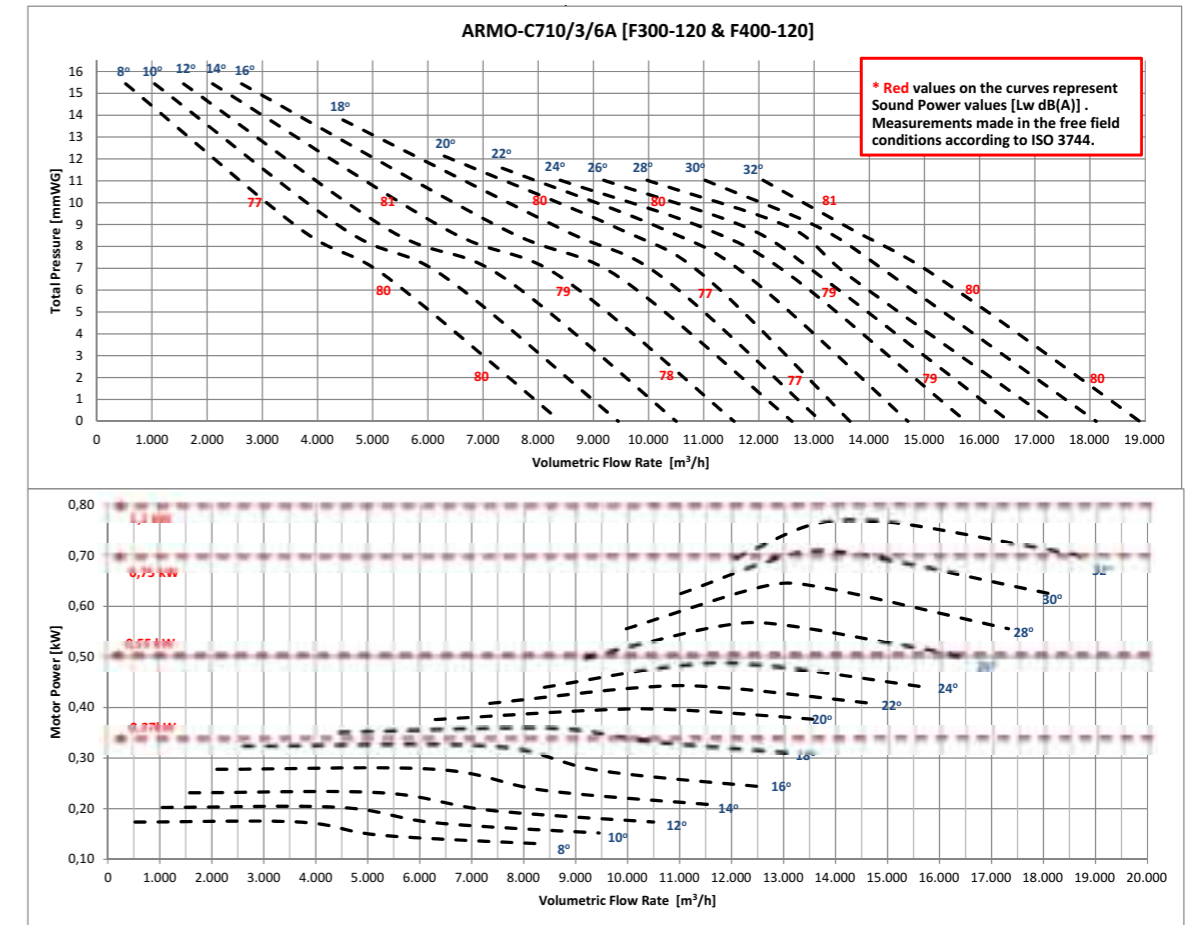
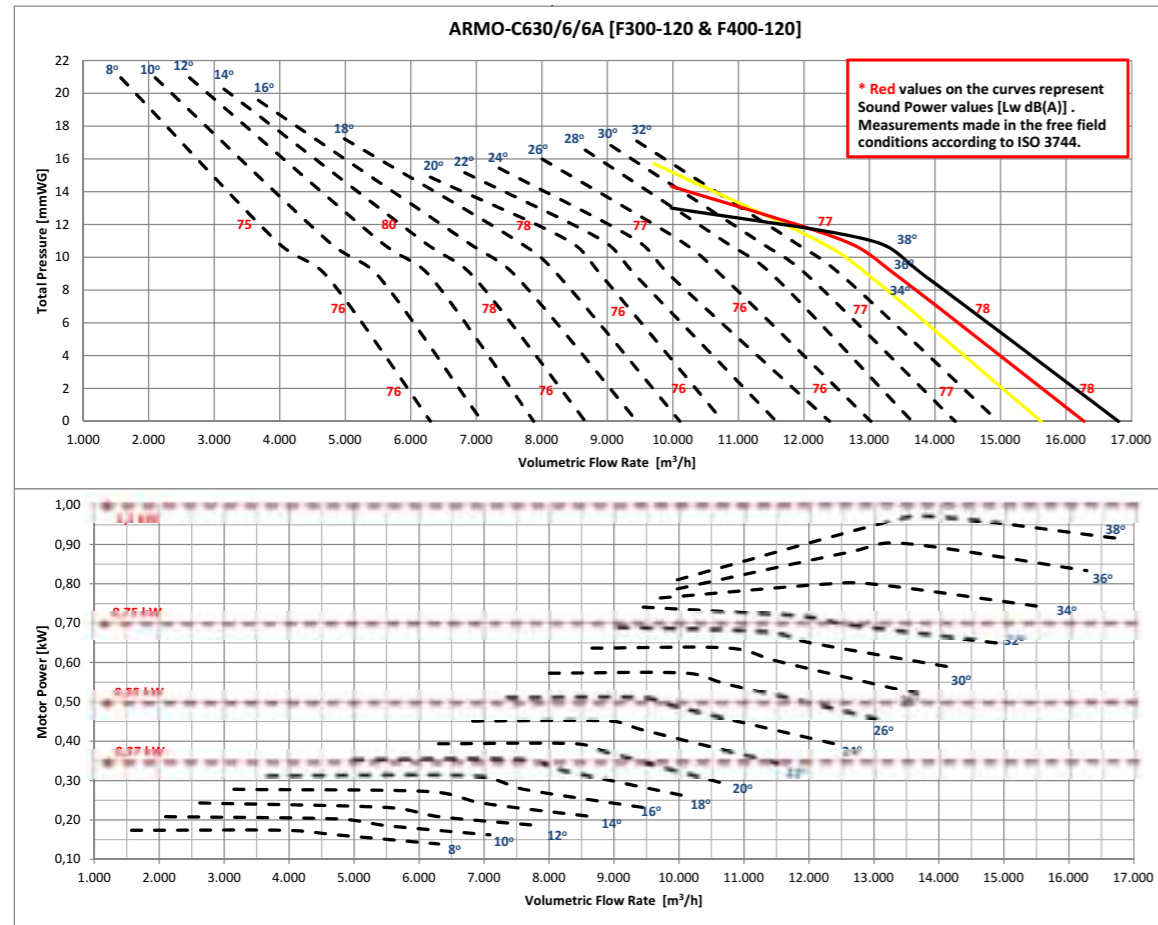

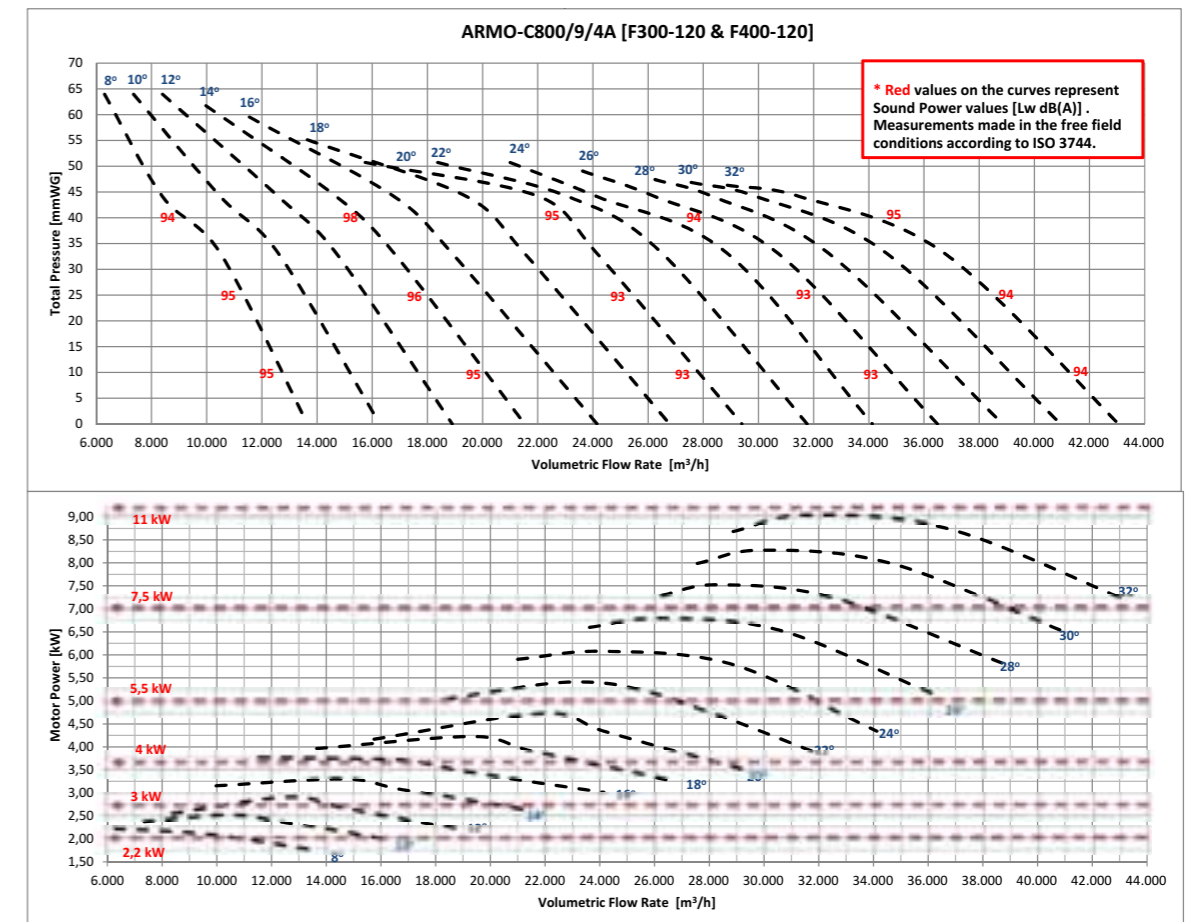
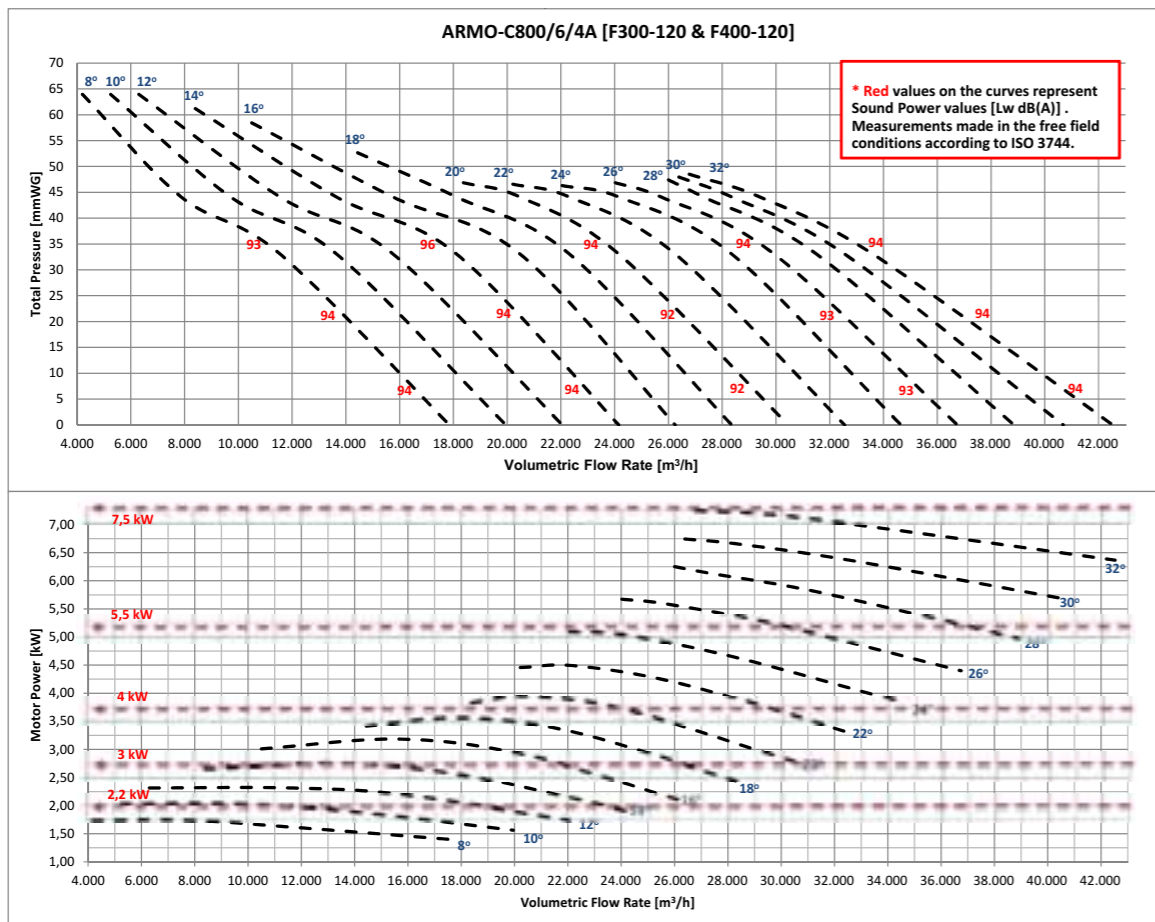
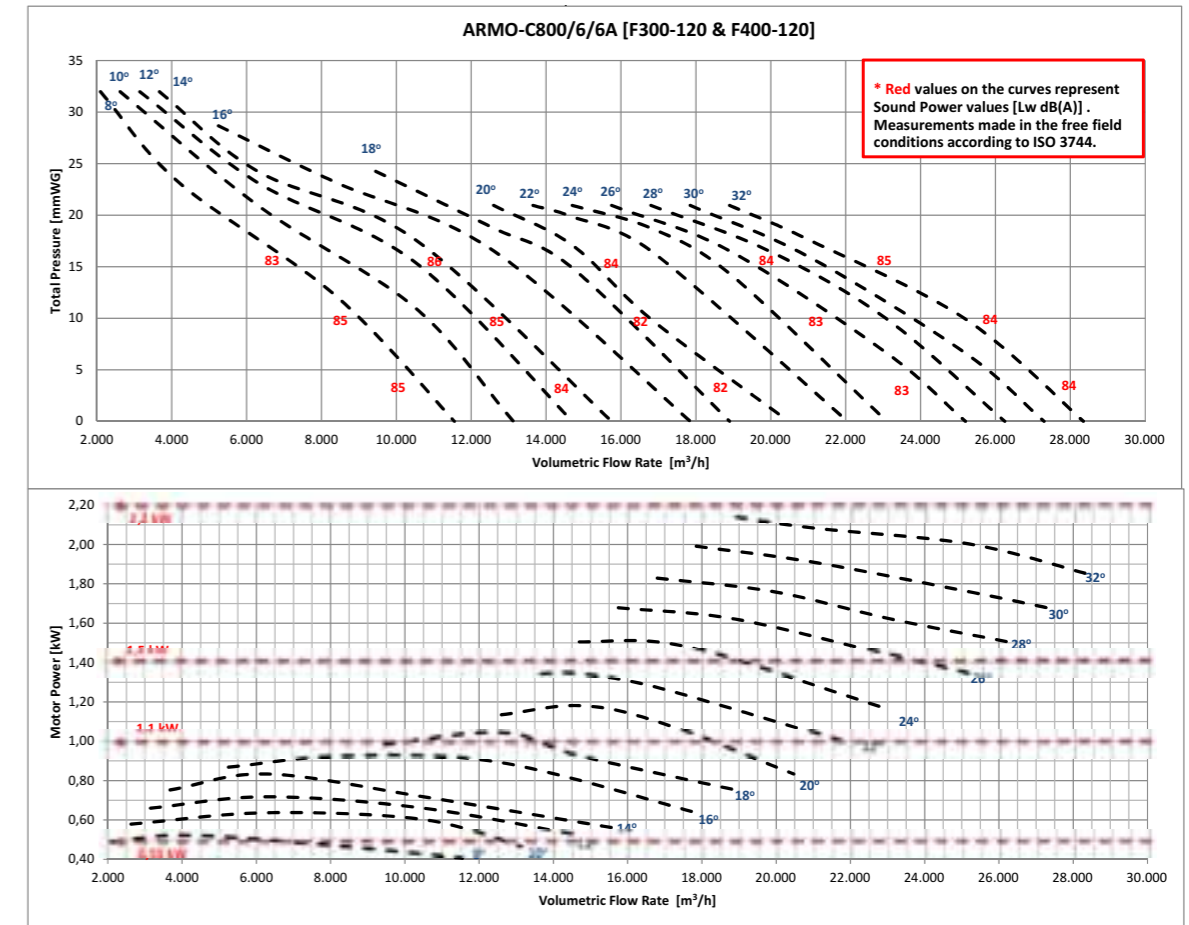
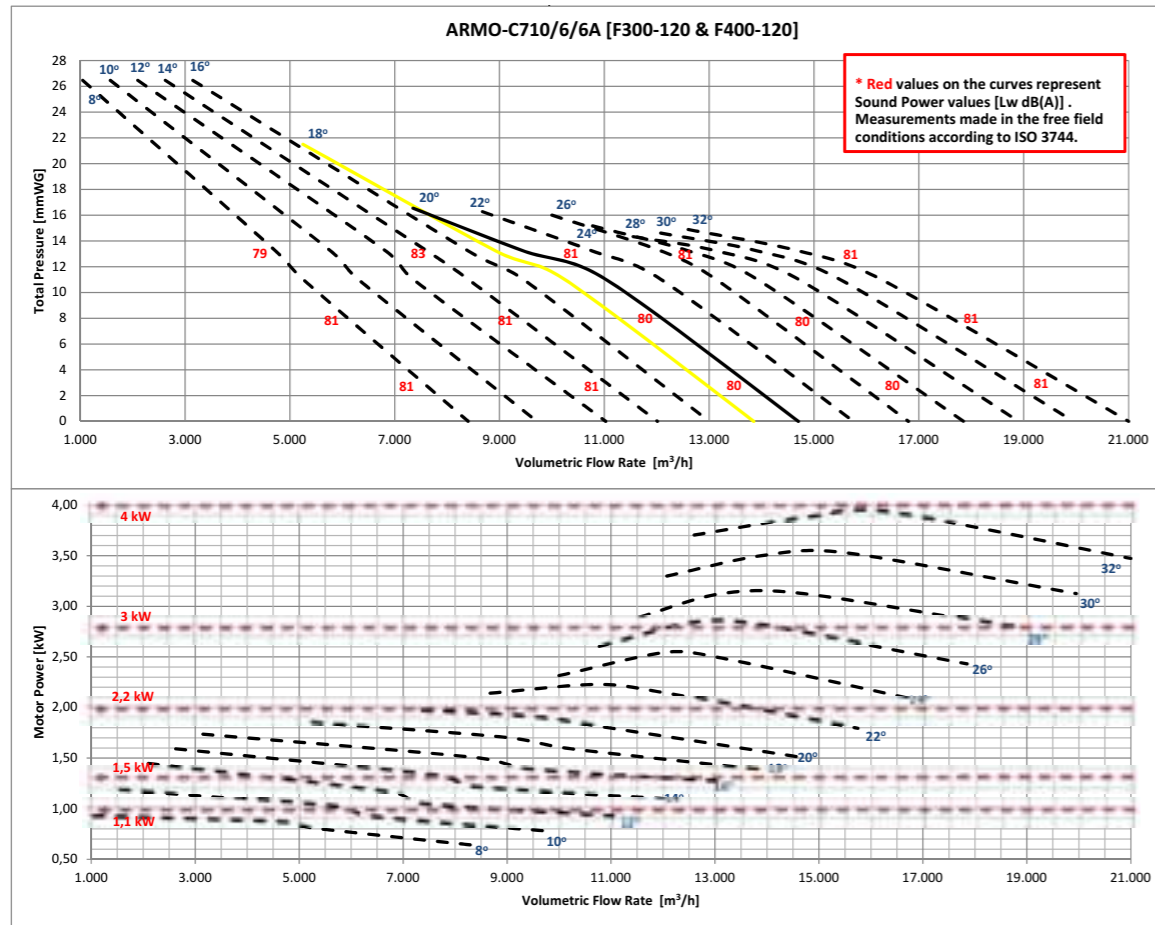

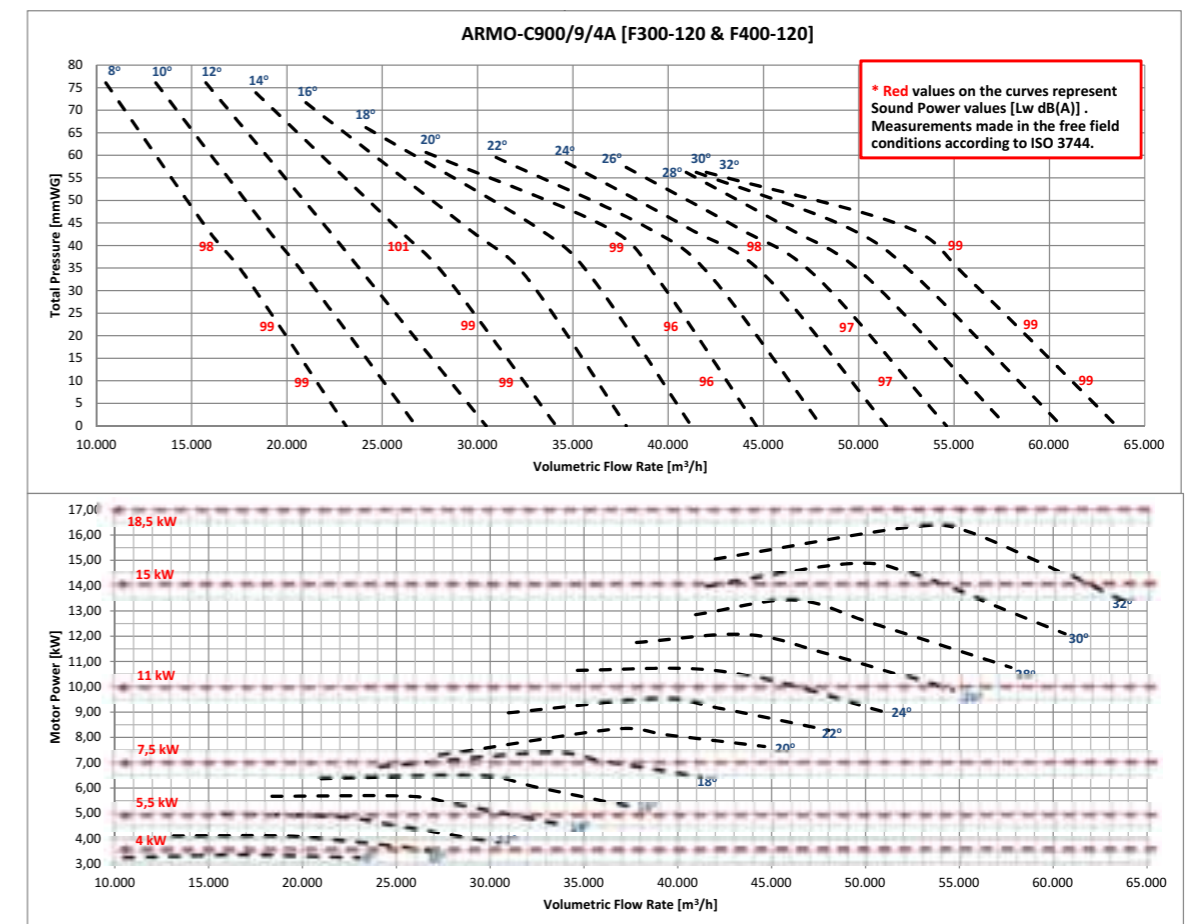
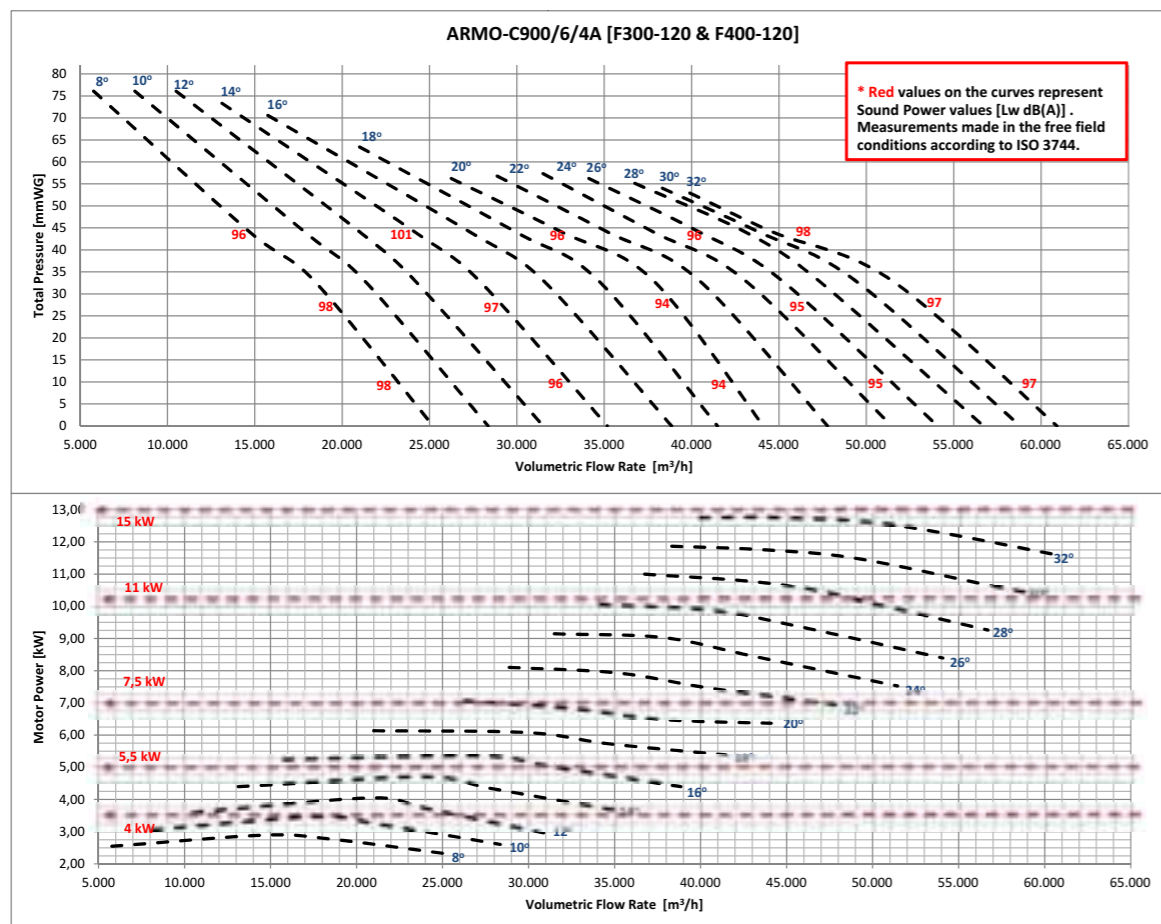
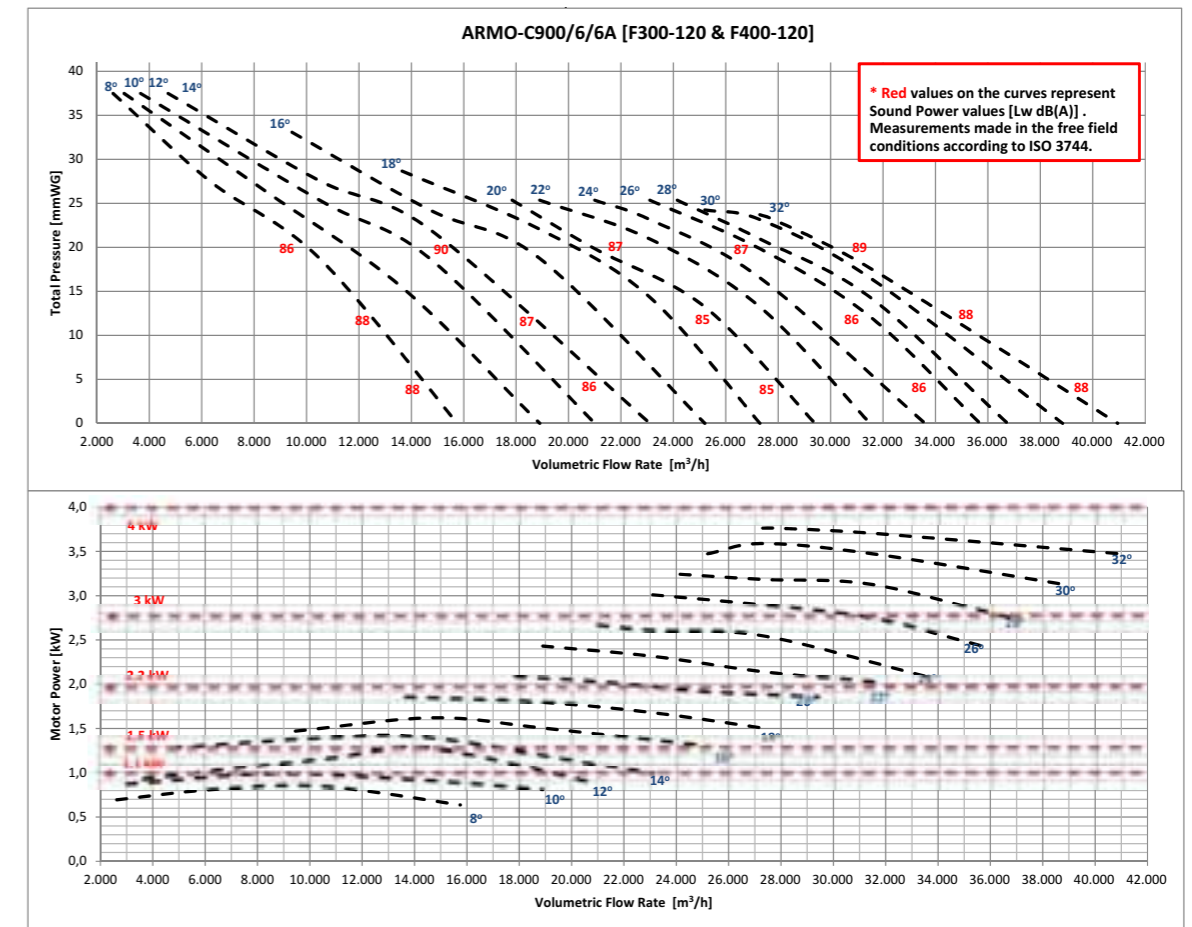
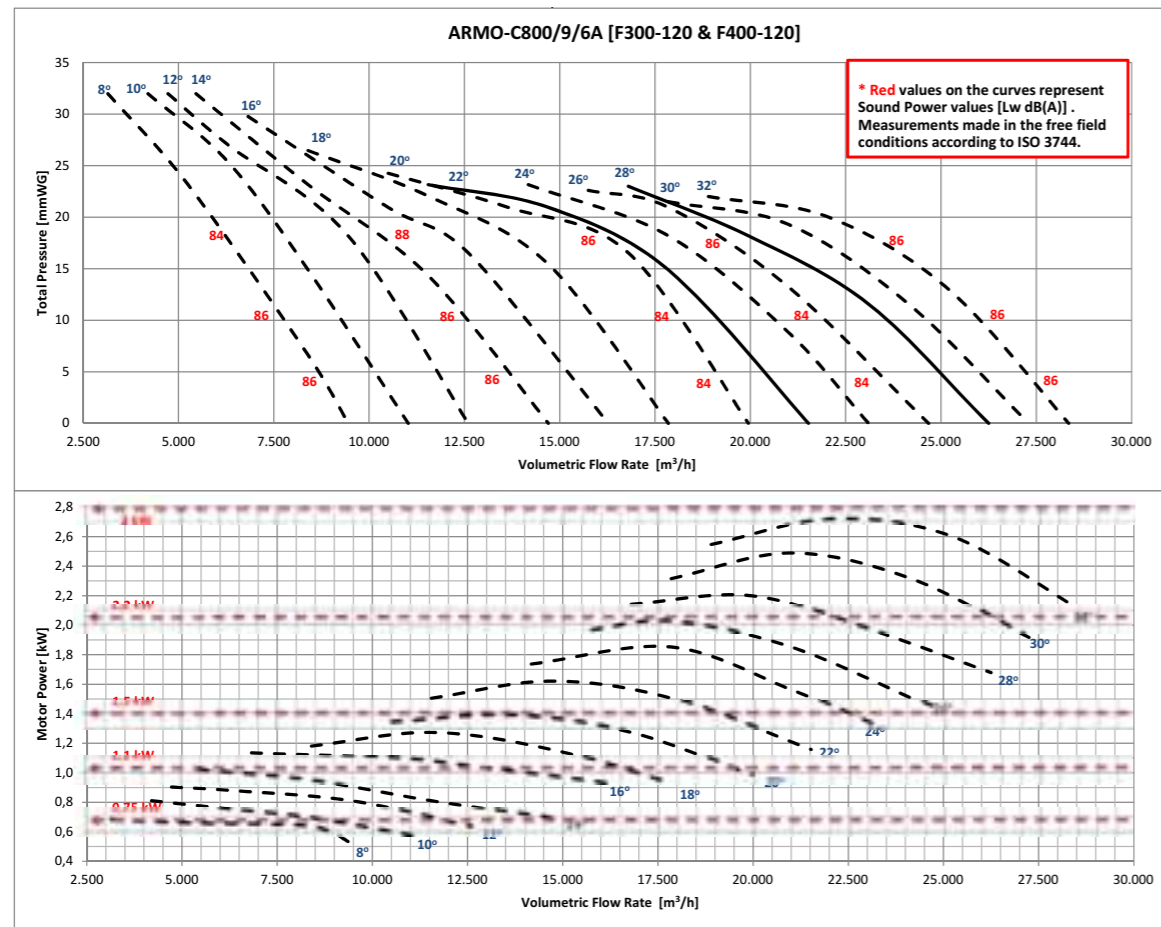

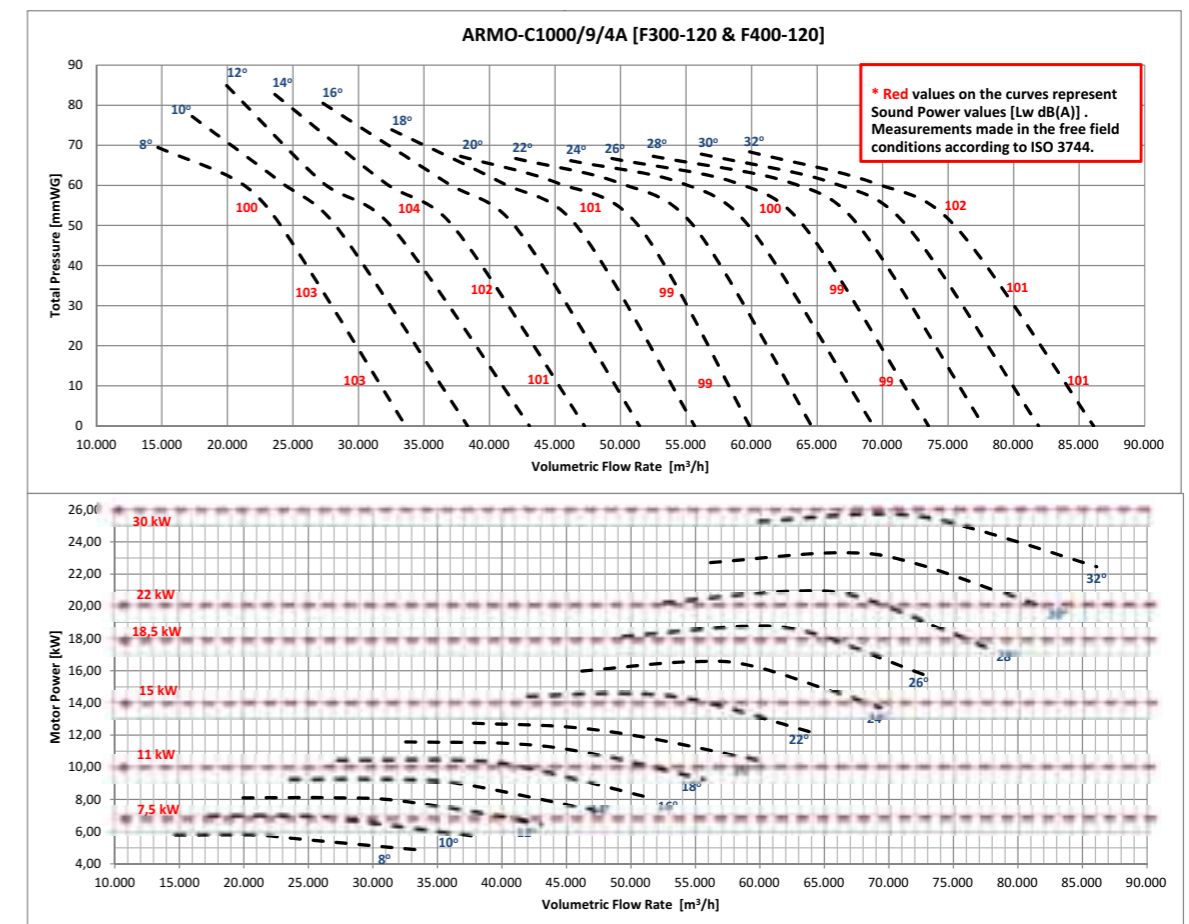
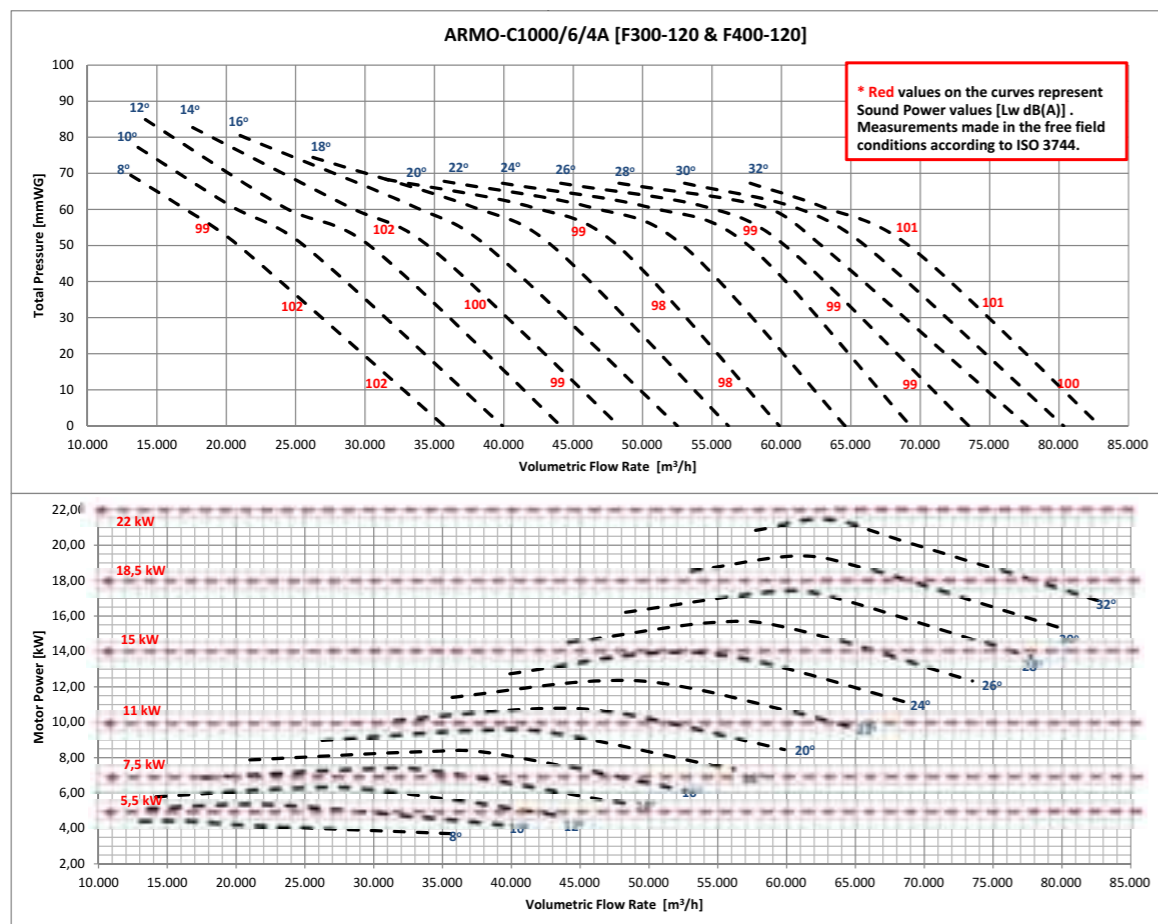
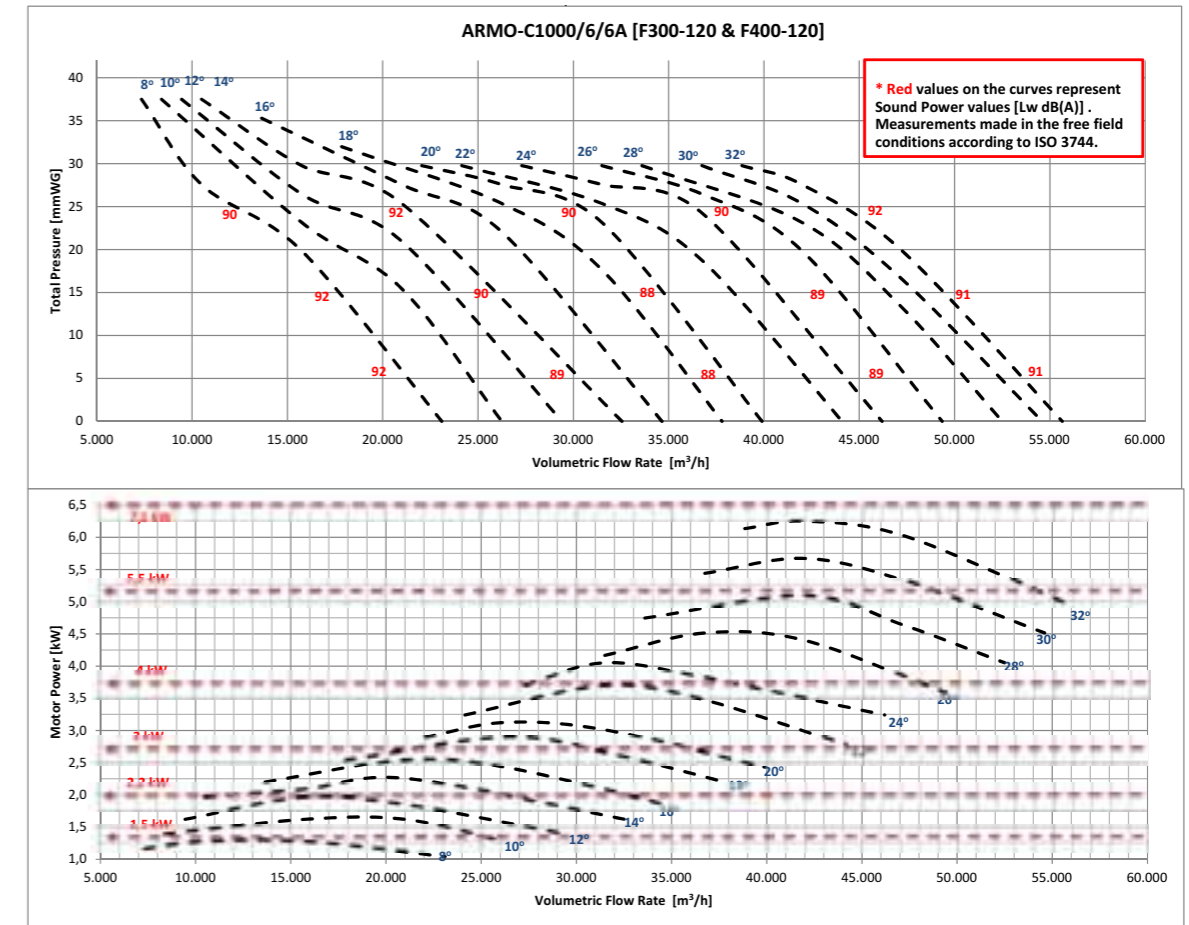
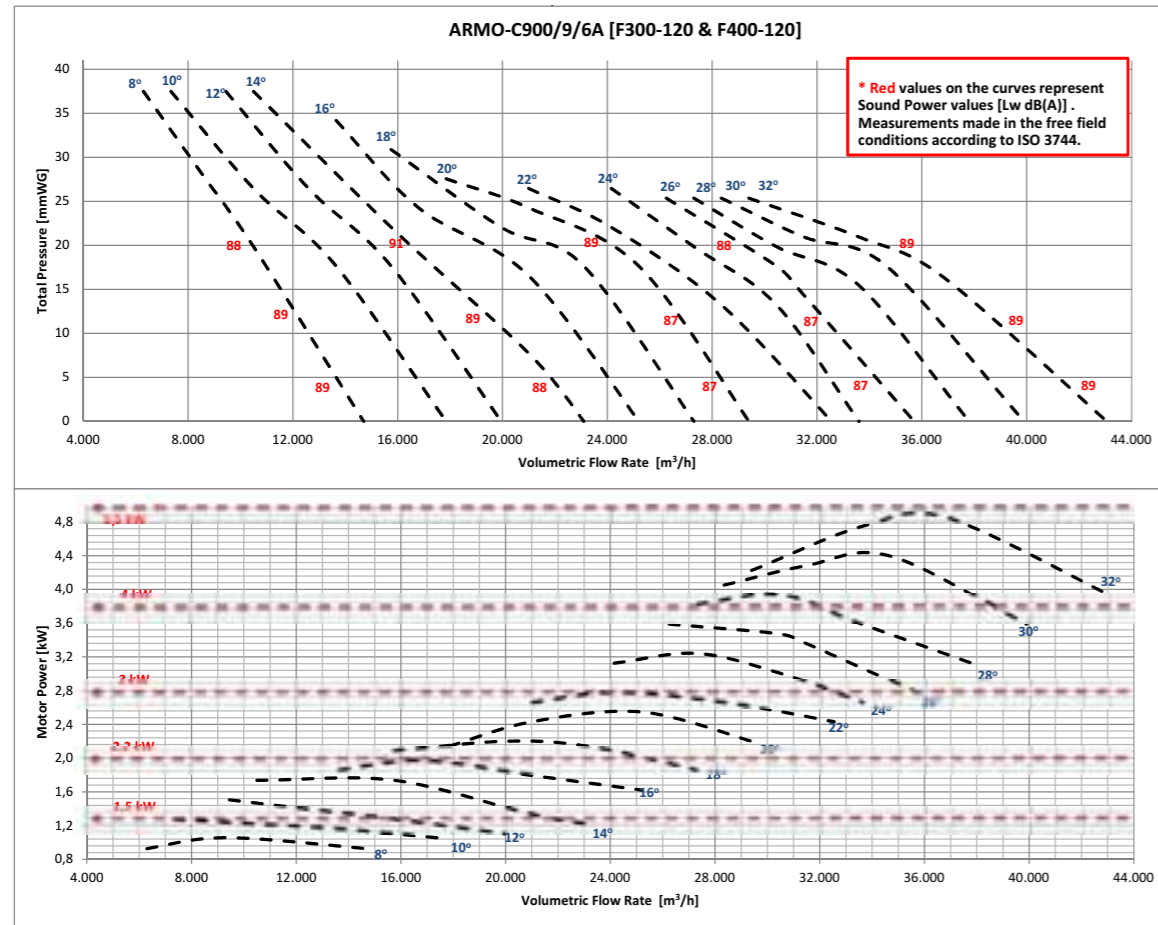

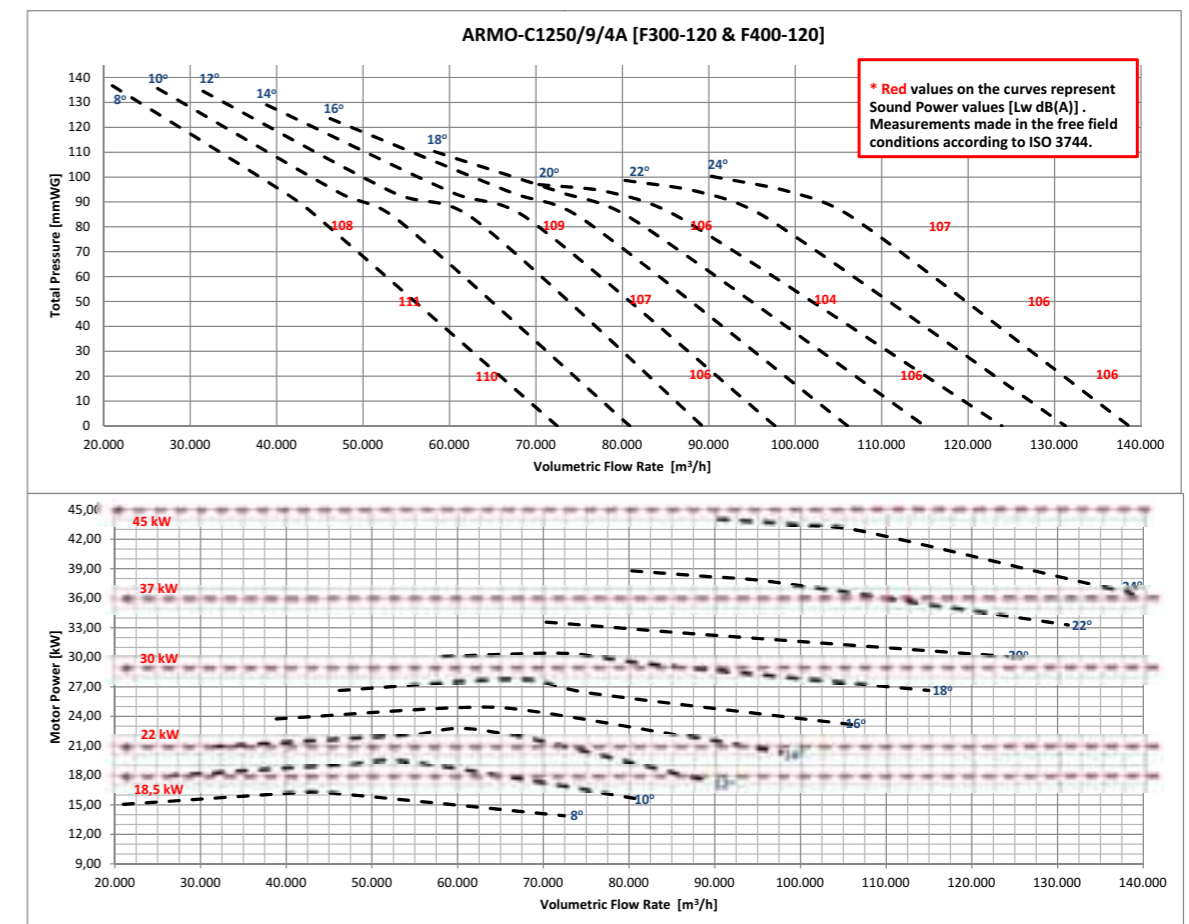
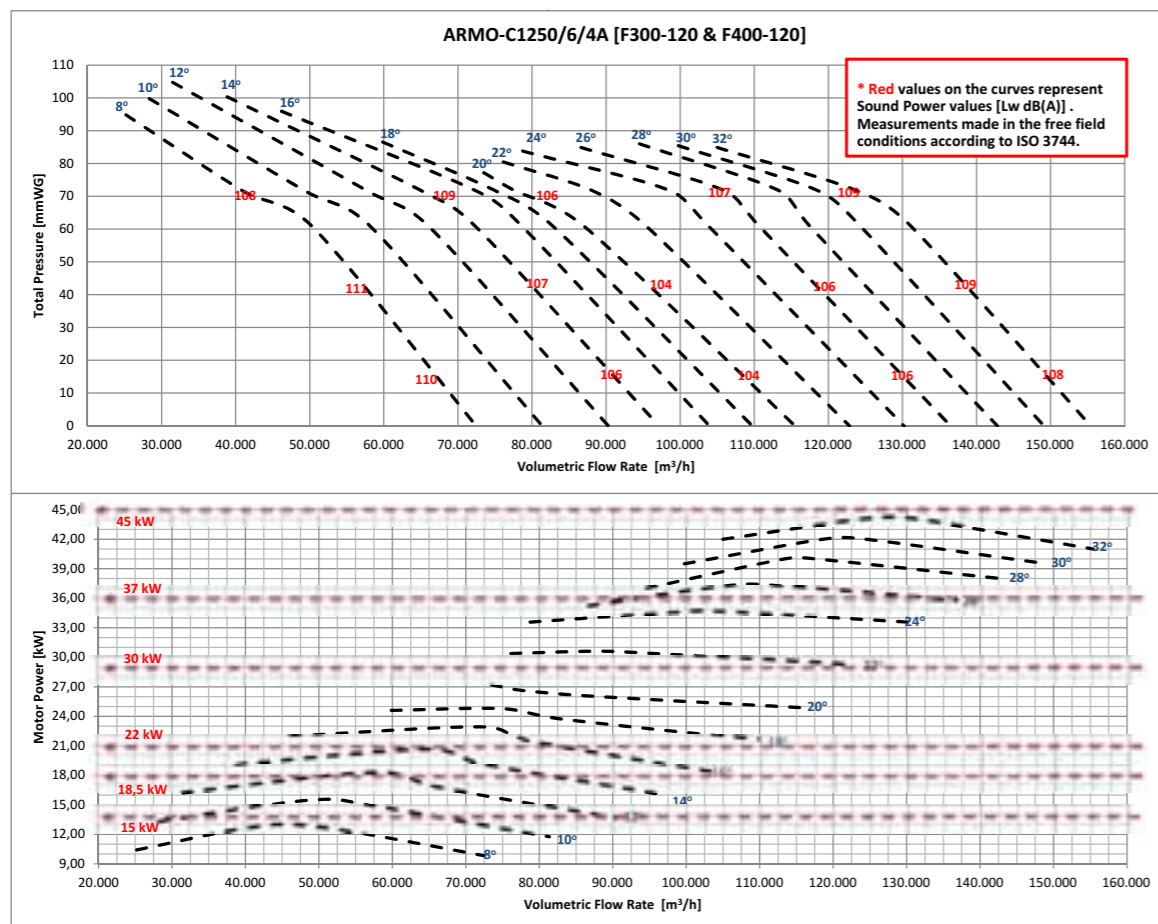
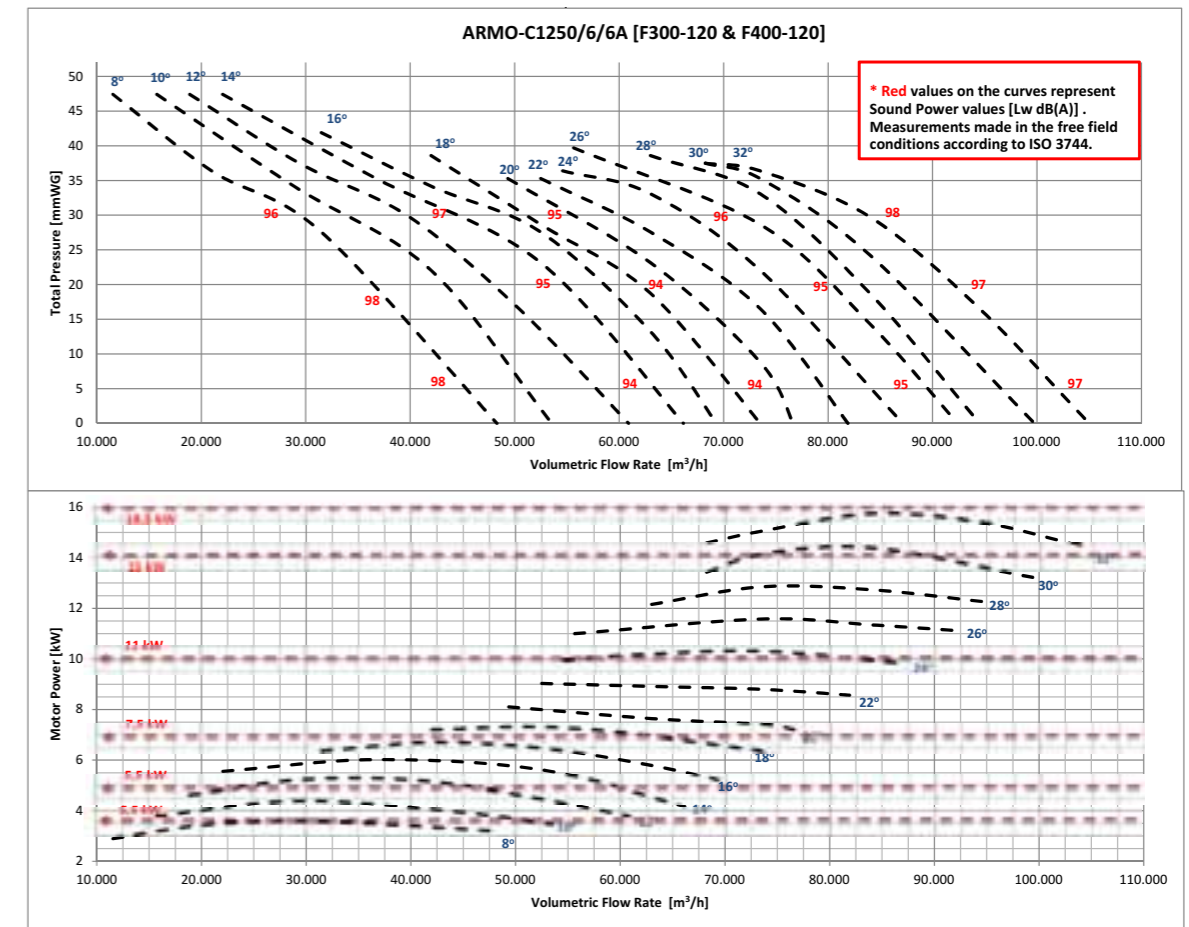
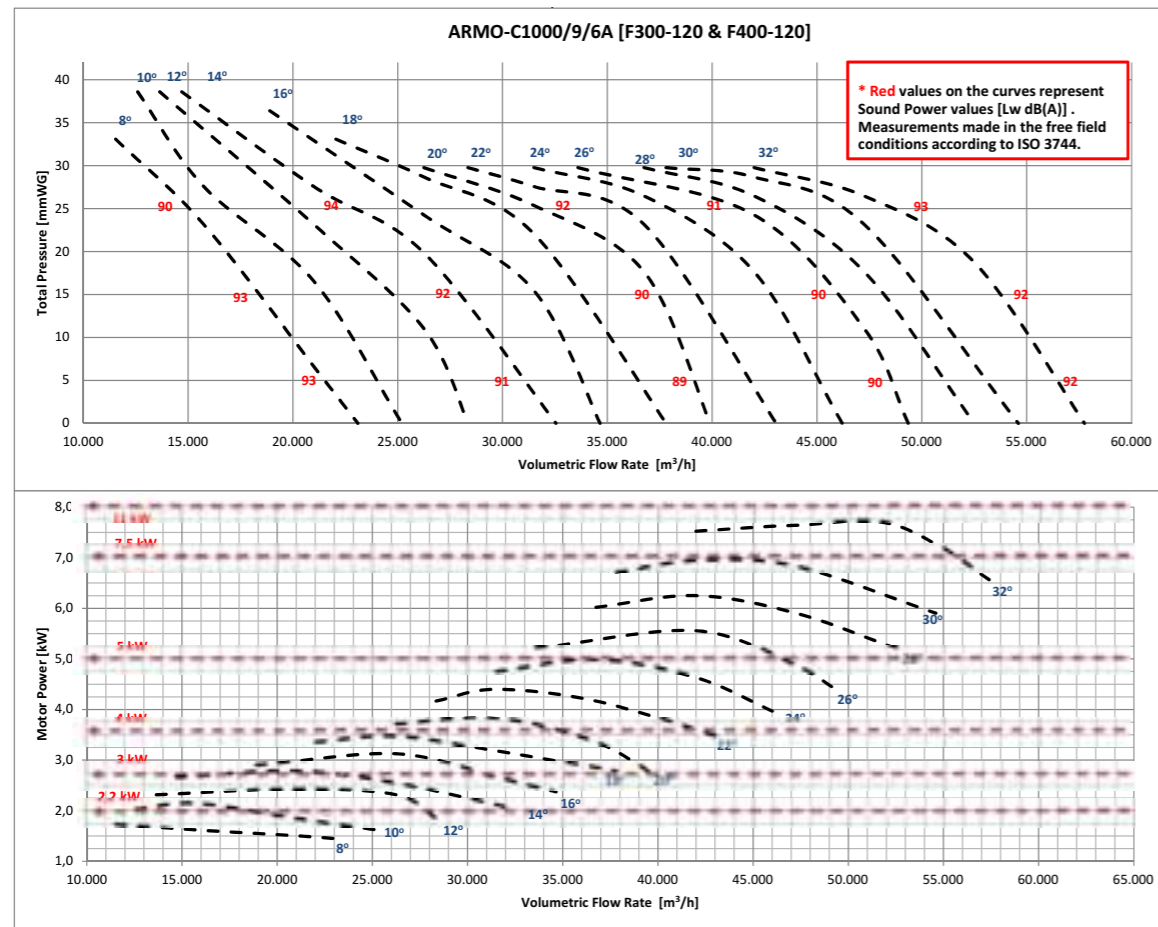

ARMO-R

SMOKE AND HEAT EXHAUST FANS / Roof



Axial roof fans are used in pressurization fan, fresh air fan and smoke exhaust fan applications. The enclosure is fire resistant and designed according to the noise standard. Smoke evacuation fans are fire resistant.

General Features

- It has EN 12101-3 and Ce certificates. • 2 hours continuous operation at 400 C and 300 C • There is a wide product range from 400 mm to 1250 mm.

Rotor Features

- Fire resistant aluminum alloy casting blades and fan hub. • Has the ability to work one-way and two-way. The blades are specially designed according to each direction type. • There is no aerodynamic loss in the case of reversible wing type operation. • Wings are airfoil and provide high aerodynamic performance in both unidirectional and bidirectional vanes. • Wing angles are adjustable. In this way, smoke discharge fans can be demanded at different flow rates and pressures. • The fan part of

the fan is dynamically balanced according to ISO 1940 and there is no eccentricity during the operation of the fan.

Body Features

- Fan body is steel sheet. Body is hot dip galvanized and corrosion resistant. • It has short type body and long type body types.

Motor Features

- Offers 2.4 and 6-pole motors • The motors are IP 55 class and Class-H insulated. • All electric motor models are approved for continuous operation (S1) and Emergency operation (S2).

Ease of Maintenance

A maintenance cover is provided to ensure easy maintenance.

Usage Areas

Roof type Axial fans are used in pressurization fan, fresh air fan and smoke exhaust fan applications.

Technical Drawing and Tables

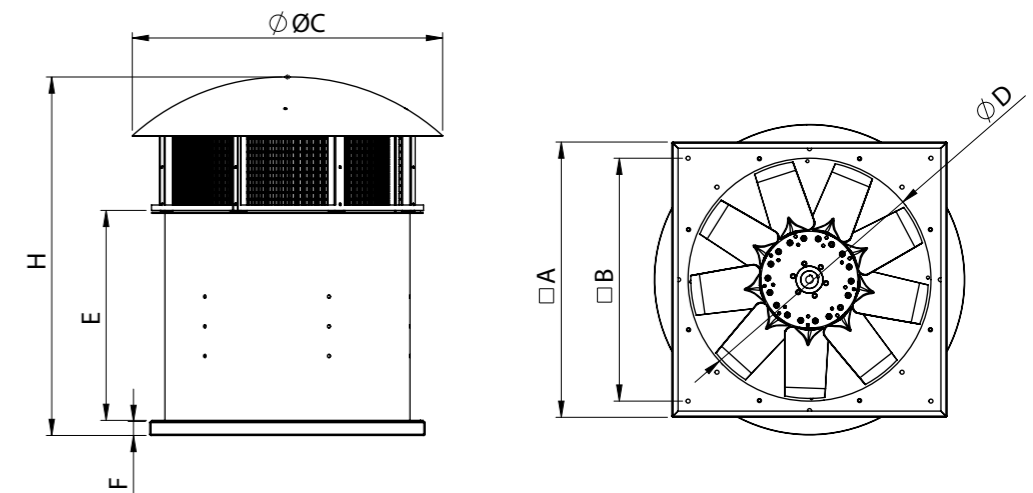

TYPE	A	B	C	D	E	H	F
ARMO-R 400	600	495	702	400	474	880	50
ARMO-R 450	650	545	702	450	474	880	50
ARMO-R 500	650	545	842	500	580	1030	50
ARMO-R 560	685	605	842	560	580	1030	50
ARMO-R 630	780	637	1130	630	600	1160	50
ARMO-R 710	830	710	1130	800	700	1300	50
ARMO-R 800	920	800	1130	800	700	1300	50
ARMO-R 900	1020	900	1130	900	775	1375	50
ARMO-R 1000	1130	1030	1430	1000	850	1450	50
ARMO-R 1250	1430	1350	1430	1250	950	1550	50

Dimensions are in (mm)

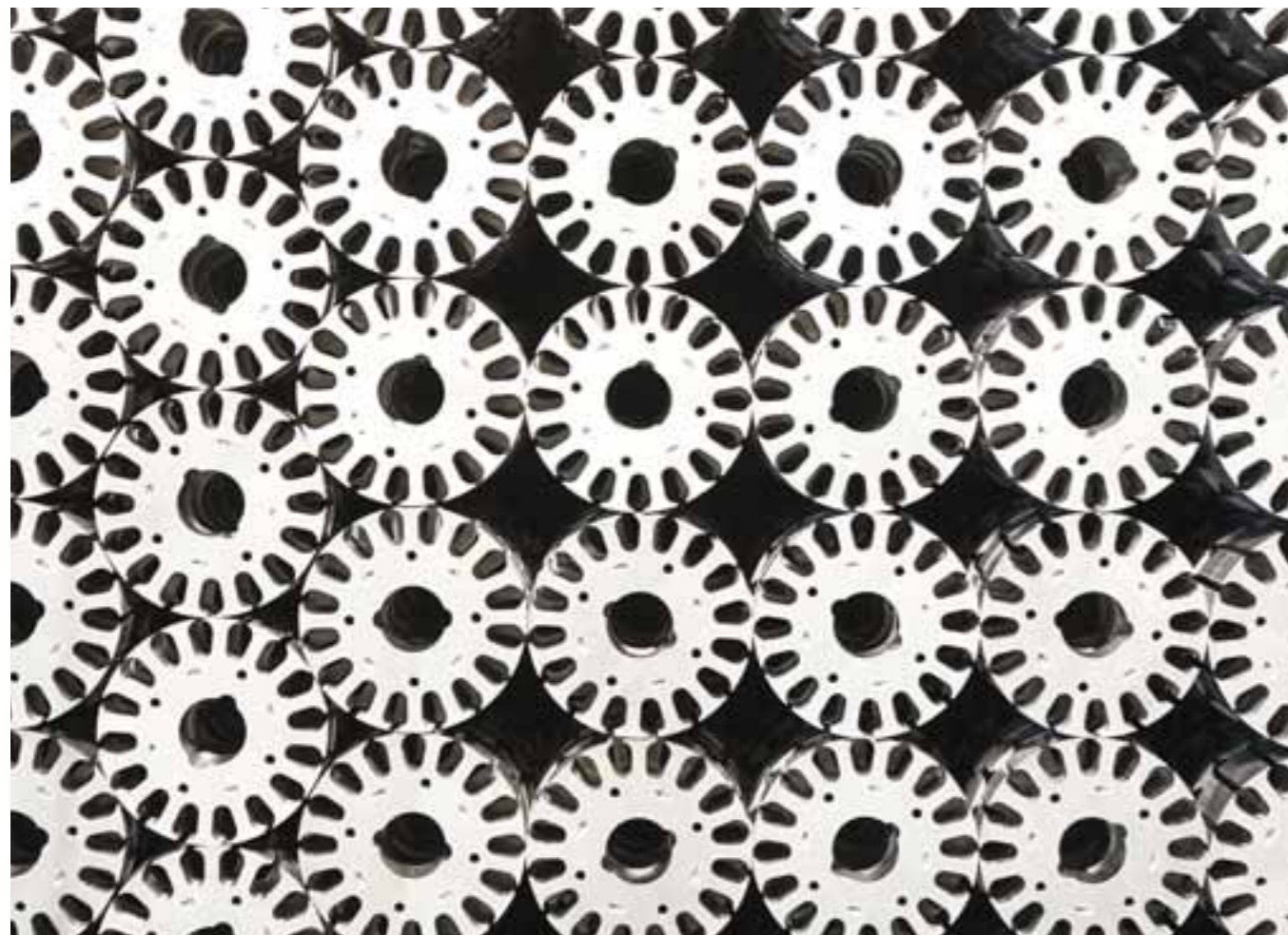
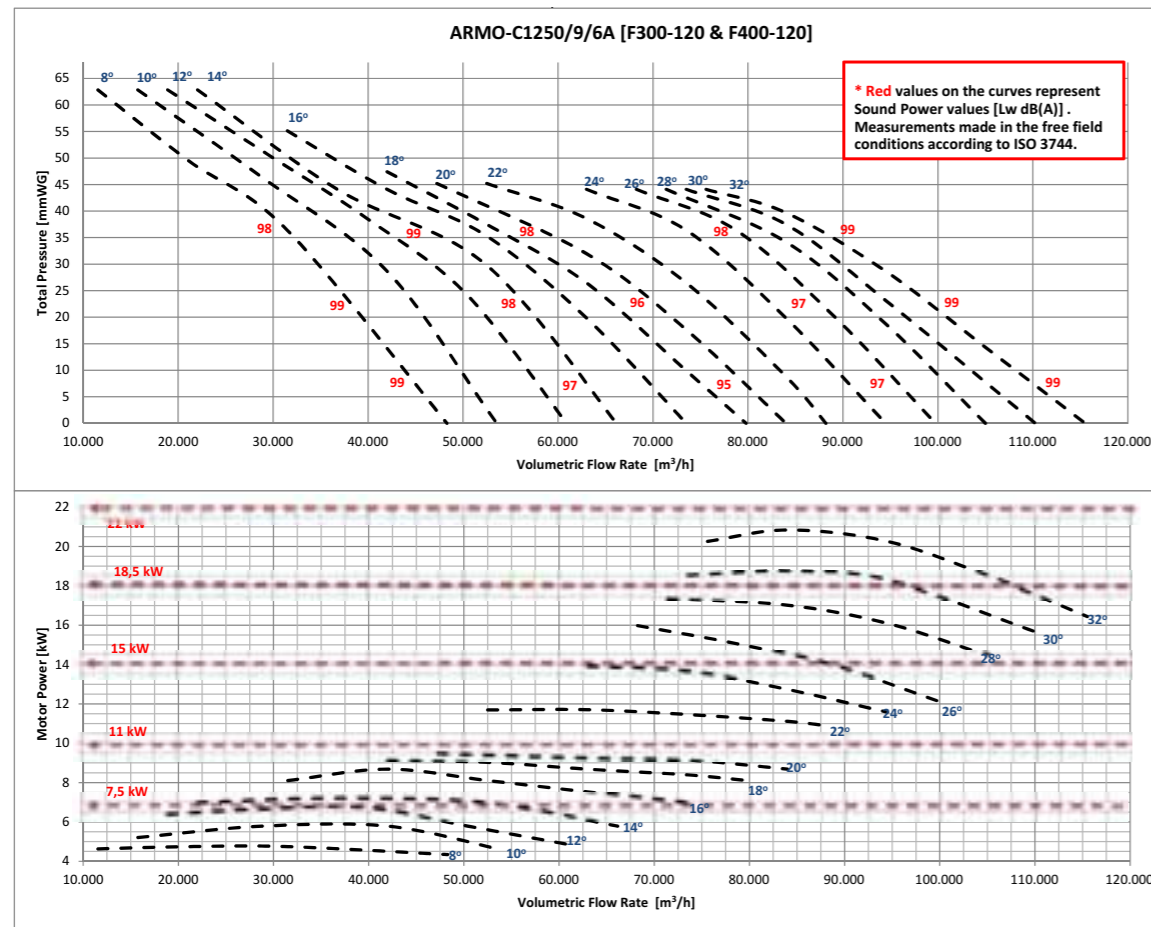



2 POLE						
TYPE	SPEED	DIAMETER	POWER	CURRENT	AIR FLOW	WING ANGLE
	r.p.m	mm	kW	230V - 400V	m ³ /h	
ARMO-R / 400-6 / 0,75 - 2A	2900	400	0,75	1,6	5250	16°
ARMO-R / 400-6 / 1,1 - 2A	2900	400	1,1	2,3	6904	22°
ARMO-R / 400-6 / 1,5 - 2A	2900	400	1,5	3,4	8978	30°
ARMO-R / 400-6 / 2,2 - 2A	2900	400	2,2	4,48	9975	34°
ARMO-R / 450-6 / 1,1 - 2A	2900	450	1,1	2,3	6248	10°
ARMO-R / 450-6 / 1,5 - 2A	2900	450	1,5	3,4	8610	16°
ARMO-R / 450-6 / 2,2 - 2A	2900	450	2,2	4,48	11970	24°
ARMO-R / 450-6 / 3 - 2A	2900	450	3	6	13545	28°
ARMO-R / 500-6 / 2,2 - 2A	2900	500	2,2	4,48	11000	14°
ARMO-R / 500-6 / 3 - 2A	2900	500	3	6	14595	20°
ARMO-R / 500-6 / 4 - 2A	2900	500	4	7,4	17325	26°
ARMO-R / 500-6 / 5,5 - 2A	2900	500	5,5	11	18375	28°
ARMO-R / 560-6 / 4 - 2A	2900	560	4	7,4	17850	14°
ARMO-R / 560-6 / 5,5 - 2A	2900	560	5,5	11	22313	20°
ARMO-R / 560-6 / 7,5 - 2A	2800	560	7,5	13,6	25725	24°
ARMO-R / 630-6 / 5,5 - 2A	2900	630	5,5	11	20475	10°
ARMO-R / 630-6 / 7,5 - 2A	2800	630	7,5	13,6	27300	16°

4 POLE						
TYPE	SPEED	DIAMETER	POWER	CURRENT	AIR FLOW	WING ANGLE
	r.p.m	mm	kW	230V - 400V	m ³ /h	
ARMO-R / 500-6 / 0,55 - 4A	1415	500	0,55	1,6	8715	26
ARMO-R / 500-6 / 0,75 - 4A	1350	500	0,75	2,1	10290	32
ARMO-R / 500-6 / 1,1 - 4A	1400	500	1,1	2,6	12600	38
ARMO-R / 560-6 / 0,55 - 4A	1415	560	0,55	1,6	9870	16
ARMO-R / 560-6 / 0,75 - 4A	1350	560	0,75	2,1	12075	22
ARMO-R / 560-6 / 1,1 - 4A	1400	560	1,1	2,6	13860	26
ARMO-R / 560-6 / 1,5 - 4A	1405	560	1,5	3,5	15750	32
ARMO-R / 560-6 / 2,2 - 4A	1410	560	2,2	5	17850	38
ARMO-R / 630-6 / 0,75 - 4A	1350	630	0,75	2,1	10605	10
ARMO-R / 630-6 / 1,1 - 4A	1400	630	1,1	2,6	16275	20
ARMO-R / 630-6 / 1,5 - 4A	1405	630	1,5	3,5	18375	24
ARMO-R / 630-6 / 2,2 - 4A	1410	630	2,2	5	21525	30
ARMO-R / 630-6 / 3 - 4A	1410	630	3	6,6	24150	36
ARMO-R / 630-6 / 4 - 4A	1500	630	4	8,2	25200	38
ARMO-R / 710-3 / 0,75 - 4A	1350	710	0,75	2,1	14175	10
ARMO-R / 710-3 / 1,1 - 4A	1400	710	1,1	2,6	18375	16
ARMO-R / 710-3 / 1,5 - 4A	1405	710	1,5	3,5	21000	20
ARMO-R / 710-3 / 2,2 - 4A	1410	710	2,2	5	24413	26
ARMO-R / 710-3 / 3 - 4A	1410	710	3	6,6	27825	32
ARMO-R / 710-6 / 1,1 - 4A	1400	710	1,1	2,6	16275	12
ARMO-R / 710-6 / 1,5 - 4A	1405	710	1,5	3,5	20475	18
ARMO-R / 710-6 / 2,2 - 4A	1410	710	2,2	5	23625	22
ARMO-R / 710-6 / 3 - 4A	1410	710	3	6,6	28350	28
ARMO-R / 710-6 / 4 - 4A	1415	710	4	8,2	31500	32
ARMO-R / 800-6 / 2,2 - 4A	1410	800	2,2	5	24150	14
ARMO-R / 800-6 / 3 - 4A	1410	800	3	6,6	30450	20
ARMO-R / 800-6 / 4 - 4A	1415	800	4	8,2	32550	22
ARMO-R / 800-6 / 5,5 - 4A	1430	800	5,5	11,2	38850	28
ARMO-R / 800-6 / 7,5 - 4A	1440	800	7,5	15,4	42525	32
ARMO-R / 800-9 / 2,2 - 4A	1410	800	2,2	5	16275	10
ARMO-R / 800-9 / 3 - 4A	1410	800	3	6,6	21525	14
ARMO-R / 800-9 / 4 - 4A	1415	800	4	8,2	29400	20
ARMO-R / 800-9 / 5,5 - 4A	1430	800	5,5	11,2	36488	26
ARMO-R / 800-9 / 7,5 - 4A	1440	800	7,5	15,4	40950	30
ARMO-R / 800-9 / 11 - 4A	1450	800	11	21	43050	32
ARMO-R / 900-6 / 4 - 4A	1415	900	4	8,2	31500	12
ARMO-R / 900-6 / 5,5 - 4A	1430	900	5,5	11,2	38850	16
ARMO-R / 900-6 / 7,5 - 4A	1440	900	7,5	15,4	47775	22
ARMO-R / 900-6 / 11 - 4A	1450	900	11	21	56700	28
ARMO-R / 900-6 / 15 - 4A	1450	900	15	29,3	60900	32
ARMO-R / 900-9 / 4 - 4A	1415	900	4	8,2	26775	10
ARMO-R / 900-9 / 5,5 - 4A	1430	900	5,5	11,2	34125	14
ARMO-R / 900-9 / 7,5 - 4A	1440	900	7,5	15,4	41213	18
ARMO-R / 900-9 / 11 - 4A	1450	900	11	21	54600	26
ARMO-R / 900-9 / 15 - 4A	1450	900	15	29,3	63525	32
ARMO-R / 1000-6 / 5,5 - 4A	1430	1000	5,5	11,2	38850	12
ARMO-R / 1000-6 / 7,5 - 4A	1440	1000	7,5	15,4	47775	18
ARMO-R / 1000-6 / 11 - 4A	1450	1000	11	21	56700	22
ARMO-R / 1000-6 / 15 - 4A	1450	1000	15	29,3	60900	28
ARMO-R / 1000-6 / 18,5 - 4A	1455	1000	18,5	34,5	56700	32
ARMO-R / 1000-9 / 7,5 - 4A	1440	1000	7,5	15,4	43050	12
ARMO-R / 1000-9 / 11 - 4A	1450	1000	11	21	55650	18
ARMO-R / 1000-9 / 15 - 4A	1450	1000	15	29,3	69300	24
ARMO-R / 1000-9 / 18,5 - 4A	1455	1000	18,5	34,5	77700	28
ARMO-R / 1000-9 / 22 - 4A	1460	1000	22	42,5	81900	30
ARMO-R / 1000-9 / 30 - 4A	1460	1000	30	55	86100	32
ARMO-R / 1250-6 / 15 - 4A	1450	1250	15	29,3	90300	12
ARMO-R / 1250-6 / 18,5 - 4A	1455	1250	18,5	34,5	103950	16
ARMO-R / 1250-6 / 22 - 4A	1460	1250	22	42,5	109725	18
ARMO-R / 1250-6 / 30 - 4A	1460	1250	30	55	122850	22
ARMO-R / 1250-6 / 37 - 4A	1470	1250	37	67	136500	26
ARMO-R / 1250-6 / 45 - 4A	1475	1250	45	80	155400	32
ARMO-R / 1250-9 / 18,5 - 4A	1455	1250	18,5	34,5	89250	12
ARMO-R / 1250-9 / 22 - 4A	1460	1250	22	42,5	97650	14
ARMO-R / 1250-9 / 30 - 4A	1460	1250	30	55	114975	18
ARMO-R / 1250-9 / 37 - 4A	1470	1250	37	67	131250	22
ARMO-R / 1250-9 / 45 - 4A	1475	1250	45	80	138600	24

6 POLE TYPE	SPEED	DIAMETER mm	POWER kW	CURRENT 230V - 400V	AIR FLOW m ³ /h	WING ANGLE
	r.p.m					
ARMO-R / 500-6 / 0,37 - 6A	900	500	0,37	1,1	8400	38
ARMO-R / 560-6 / 0,37 - 6A	900	560	0,37	1,1	10500	32
ARMO-R / 560-6 / 0,55 - 6A	930	560	0,55	1,5	11760	38
ARMO-R / 630-6 / 0,37 - 6A	900	630	0,37	1,1	11576	22
ARMO-R / 630-6 / 0,55 - 6A	930	630	0,55	1,5	13650	28
ARMO-R / 630-6 / 0,75 - 6A	945	630	0,75	2	14963	32
ARMO-R / 630-6 / 1,1 - 6A	945	630	1,1	2,9	16800	38
ARMO-R / 710-3 / 0,37 - 6A	900	710	0,37	1,1	13125	18
ARMO-R / 710-3 / 0,55 - 6A	930	710	0,55	1,5	16538	26
ARMO-R / 710-3 / 0,75 - 6A	945	710	0,75	2	18900	32
ARMO-R / 710-6 / 1,1 - 6A	945	710	1,1	2,9	11025	12
ARMO-R / 710-6 / 1,5 - 6A	945	710	1,5	3,6	13000	16
ARMO-R / 710-6 / 2,2 - 6A	950	710	2,2	5,4	13750	22
ARMO-R / 710-6 / 3 - 6A	950	710	3	6,9	18900	28
ARMO-R / 710-6 / 4 - 6A	955	710	4	9	21000	32
ARMO-R / 800-6 / 0,55 - 6A	930	800	0,55		13125	10
ARMO-R / 800-6 / 1,1 - 6A	945	800	1,1	2,9	22050	22
ARMO-R / 800-6 / 1,5 - 6A	945	800	1,5	3,6	25200	26
ARMO-R / 800-6 / 2,2 - 6A	950	800	2,2	5,4	28350	32
ARMO-R / 800-9 / 0,75 - 6A	945	800	0,75	2	14700	14
ARMO-R / 800-9 / 1,1 - 6A	945	800	1,1	2,9	19950	20
ARMO-R / 800-9 / 1,5 - 6A	945	800	1,5	3,6	23100	24
ARMO-R / 800-9 / 2,2 - 6A	950	800	2,2	5,4	27300	30
ARMO-R / 800-9 / 3 - 6A	950	800	3	6,9	28350	32
ARMO-R / 900-6 / 1,1 - 6A	945	900	1,1	2,9	23100	14
ARMO-R / 900-6 / 1,5 - 6A	945	900	1,5	3,6	25200	16
ARMO-R / 900-6 / 2,2 - 6A	950	900	2,2	5,4	31500	22
ARMO-R / 900-6 / 3 - 6A	950	900	3	6,9	36750	28
ARMO-R / 900-6 / 4 - 6A	955	900	4	9	40950	32
ARMO-R / 900-9 / 1,5 - 6A	945	900	1,5	3,6	23100	14
ARMO-R / 900-9 / 2,2 - 6A	950	900	2,2	5,4	27300	20
ARMO-R / 900-9 / 3 - 6A	950	900	3	6,9	35700	24
ARMO-R / 900-9 / 4 - 6A	955	900	4	9	39900	30
ARMO-R / 900-9 / 5,5 - 6A	985	900	5,5	12,3	43050	32
ARMO-R / 1000-6 / 1,5 - 6A	945	1000	1,5	3,6	26250	10
ARMO-R / 1000-6 / 2,2 - 6A	950	1000	2,2	5,4	34650	16
ARMO-R / 1000-6 / 3 - 6A	950	1000	3	6,9	44100	22
ARMO-R / 1000-6 / 4 - 6A	955	1000	4	9	49350	26
ARMO-R / 1000-6 / 5,5 - 6A	985	1000	5,5	12,3	55650	32
ARMO-R / 1000-9 / 2,2 - 6A	950	1000	2,2	5,4	32550	14
ARMO-R / 1000-9 / 3 - 6A	950	1000	3	6,9	39900	20
ARMO-R / 1000-9 / 4 - 6A	955	1000	4	9	43050	22
ARMO-R / 1000-9 / 5,5 - 6A	985	1000	5,5	12,3	52500	28
ARMO-R / 1000-9 / 7,5 - 6A	960	1000	7,5	15	57750	32
ARMO-R / 1250-6 / 4 - 6A	955	1250	4	9	60900	12
ARMO-R / 1250-6 / 5,5 - 6A	985	1250	5,5	12,3	63300	16
ARMO-R / 1250-6 / 7,5 - 6A	960	1250	7,5	15	76650	20
ARMO-R / 1250-6 / 11 - 6A	960	1250	11	22	92400	26
ARMO-R / 1250-6 / 15 - 6A	965	1250	15	29	105000	32
ARMO-R / 1250-9 / 7,5 - 6A	960	1250	7,5	15	73500	16
ARMO-R / 1250-9 / 11 - 6A	960	1250	11	22	88200	22
ARMO-R / 1250-9 / 15 - 6A	965	1250	15	29	105000	28
ARMO-R / 1250-9 / 18,5 - 6A	970	1250	18,5	36,5	115500	32

Accessories



BSC-F

BSST

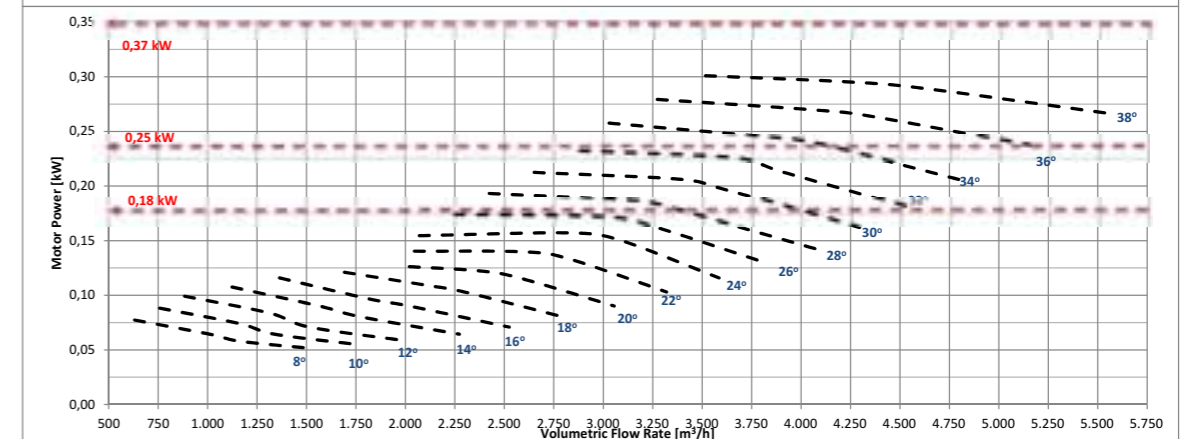
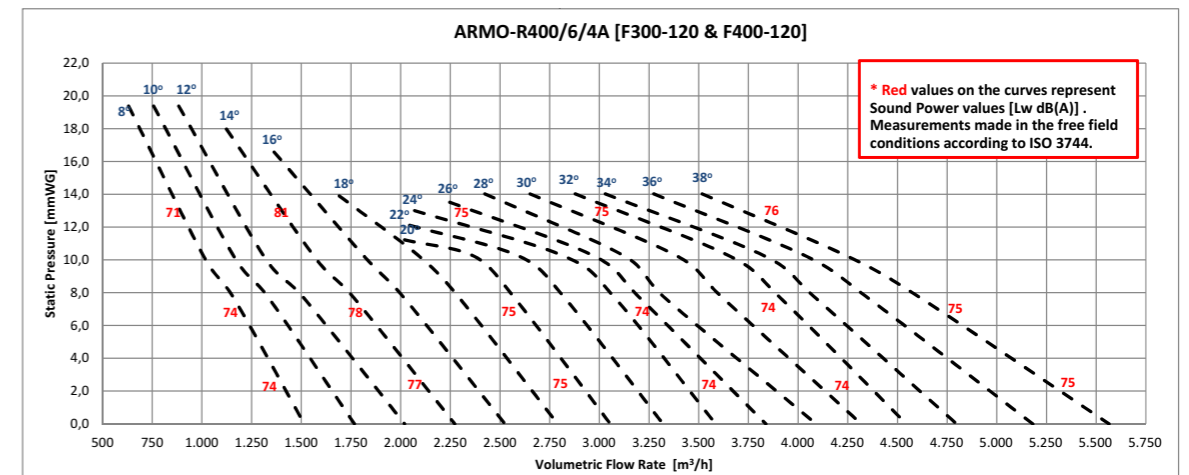
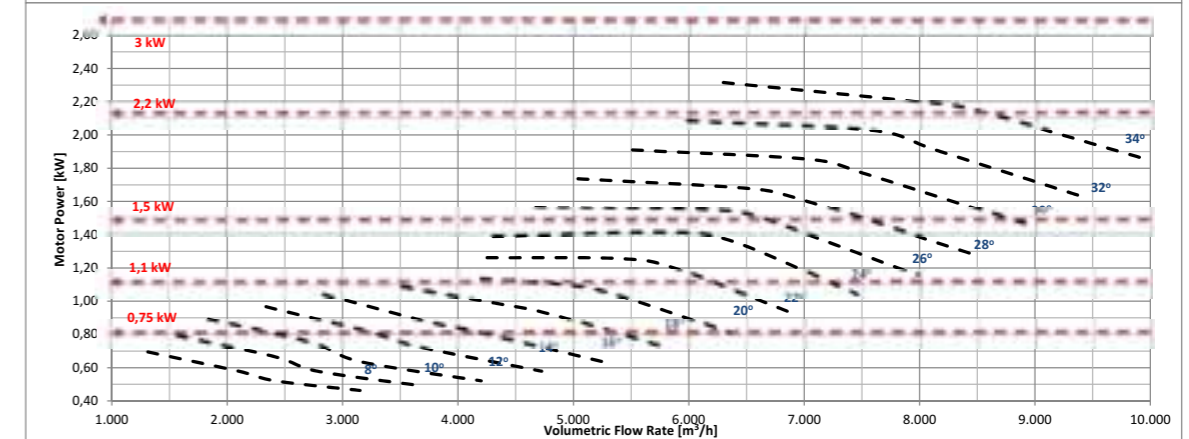
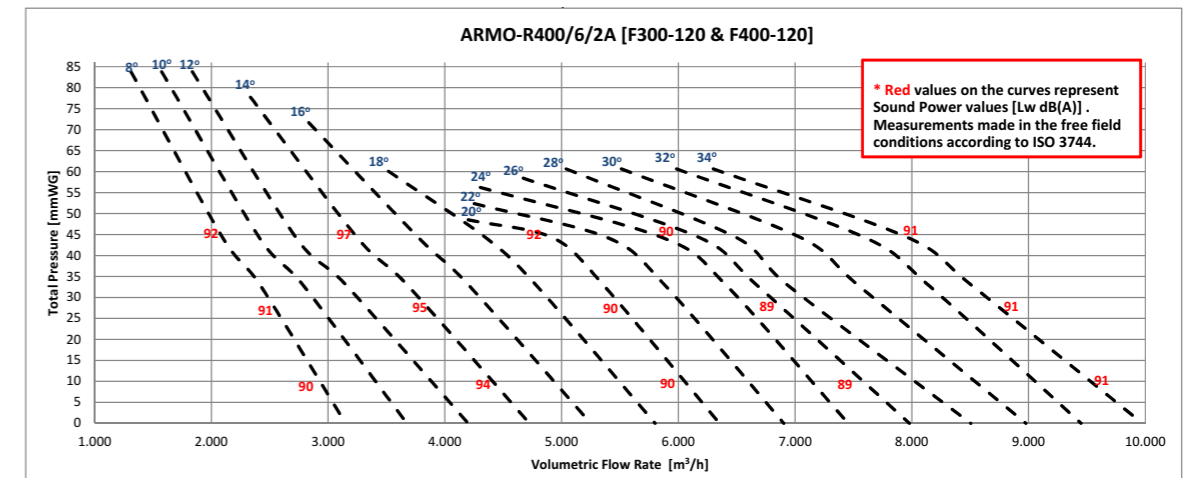

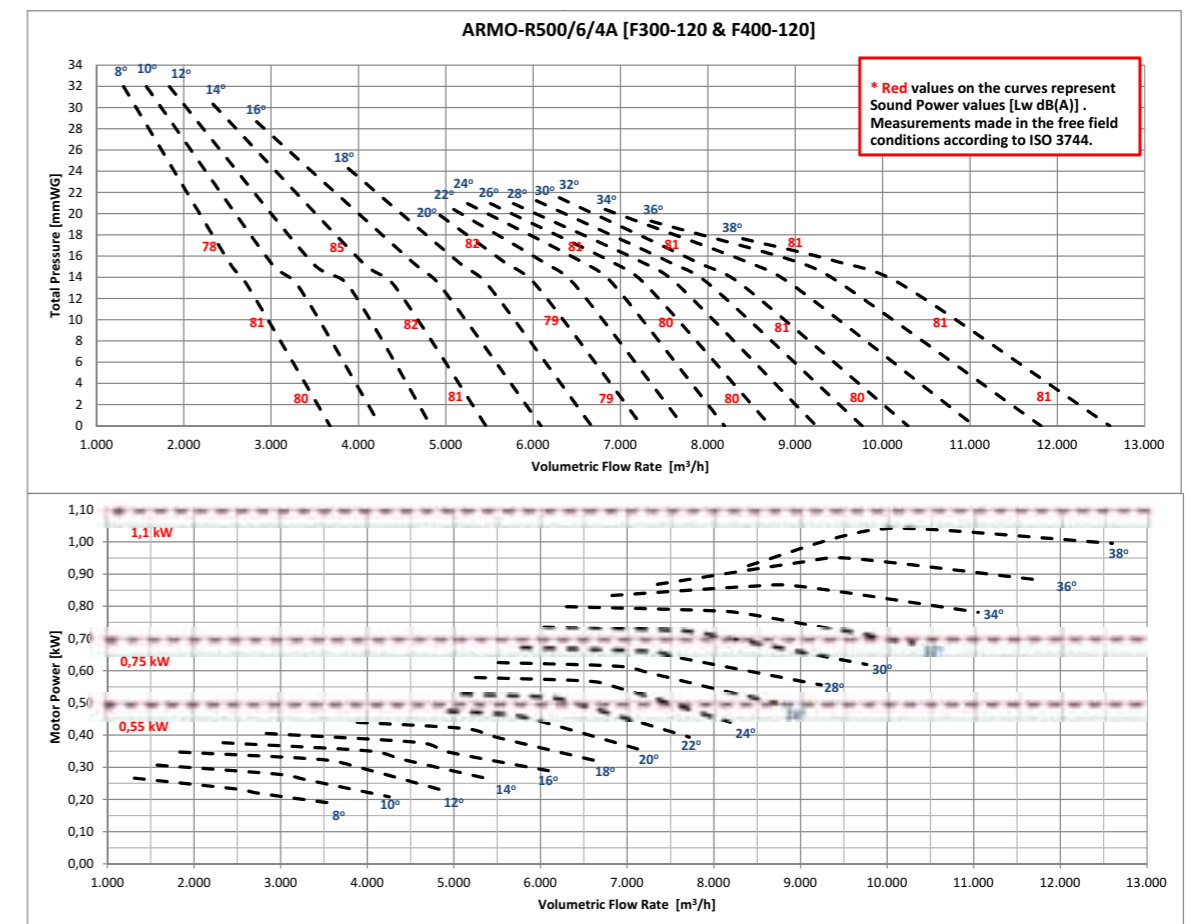
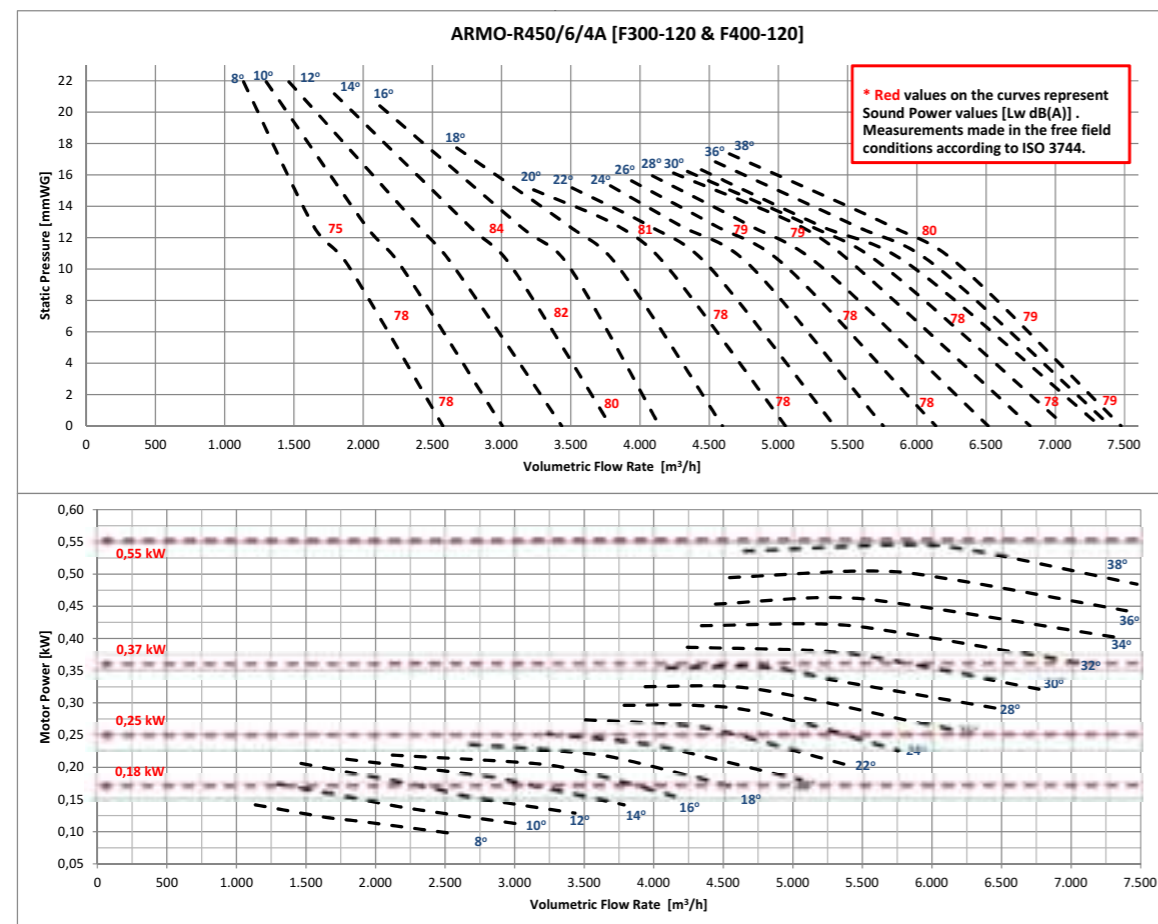
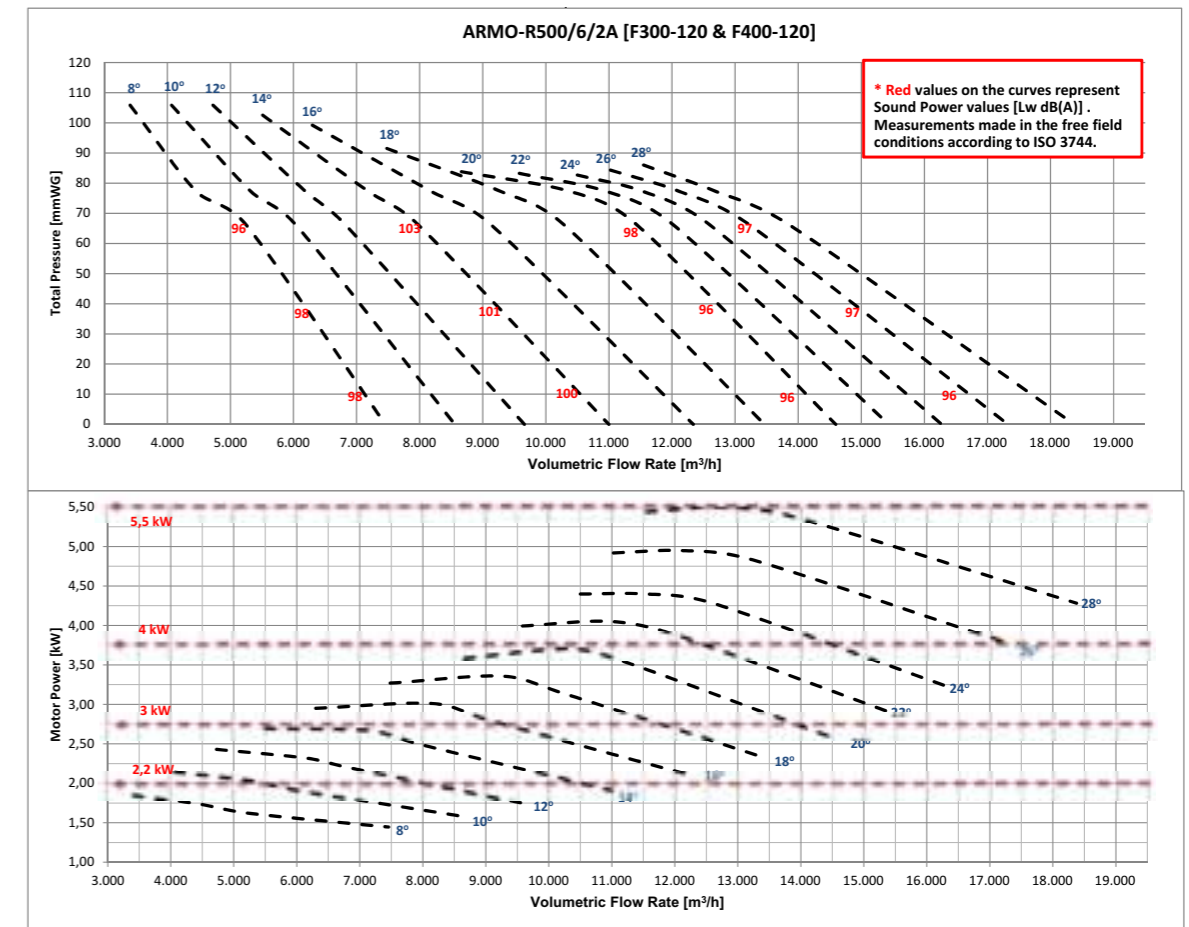
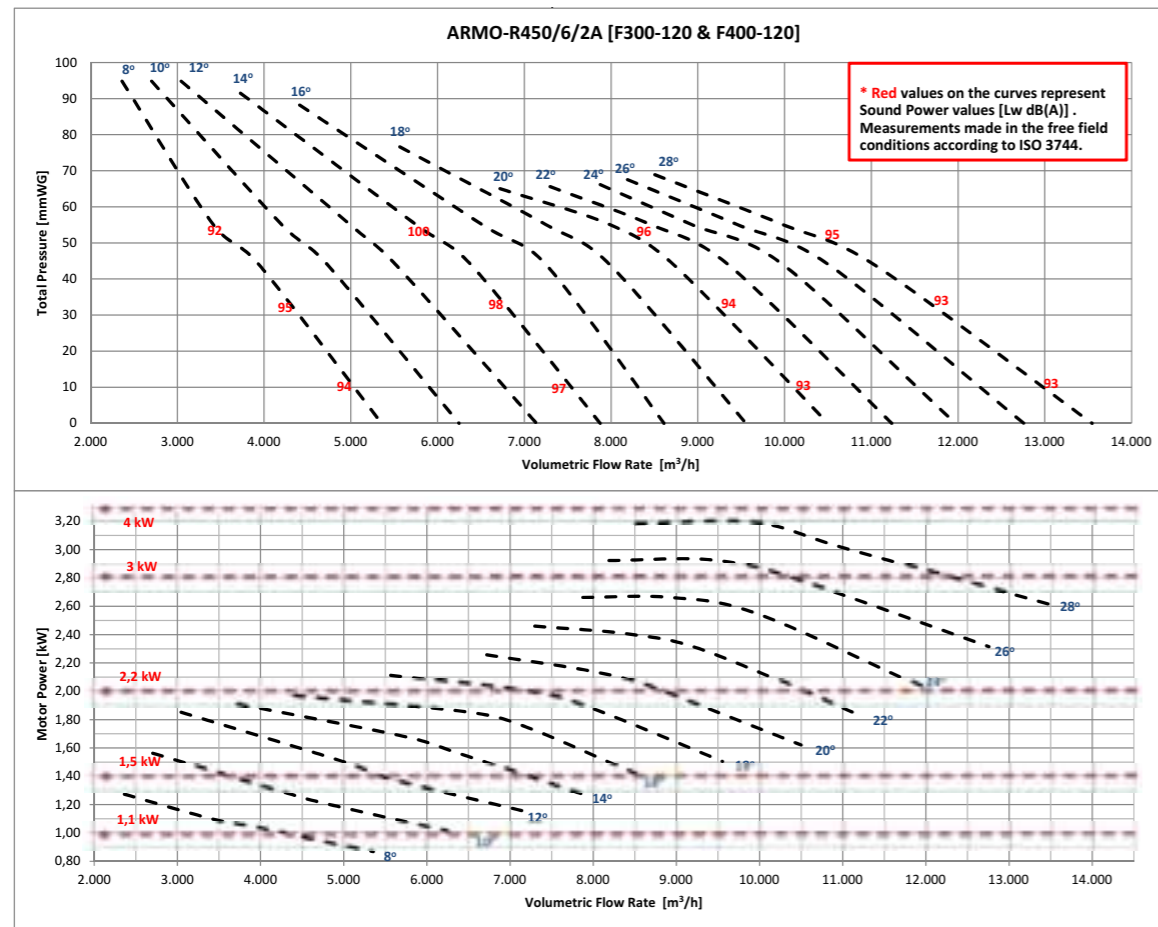

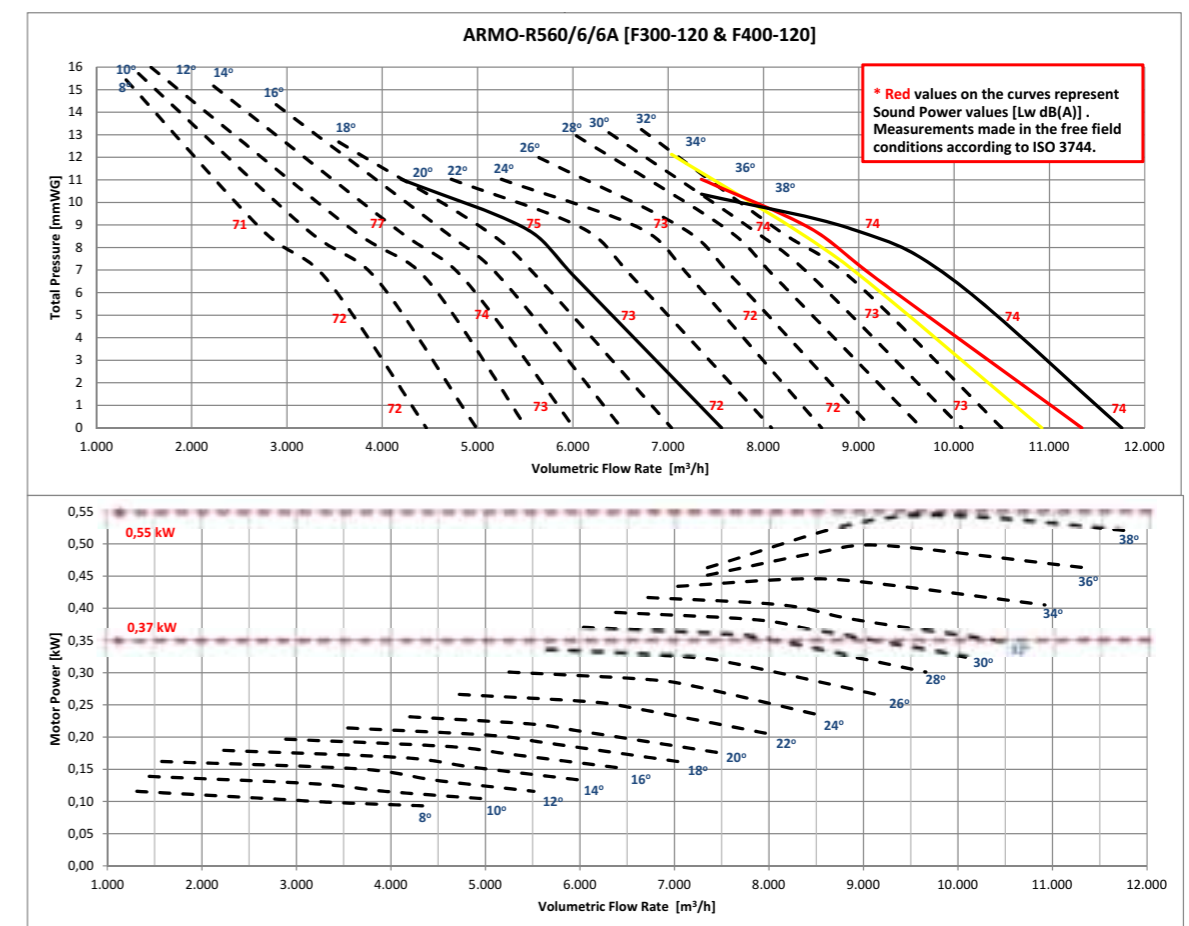
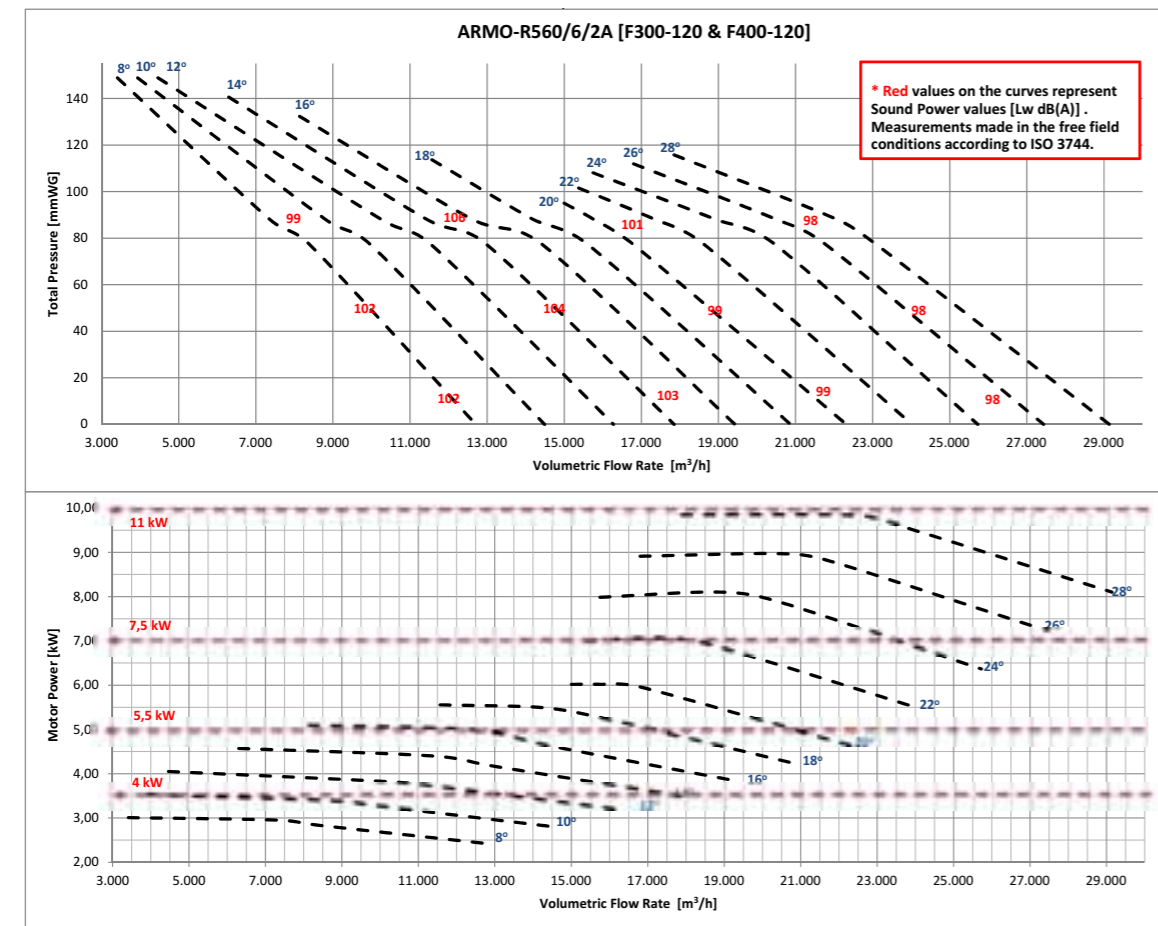
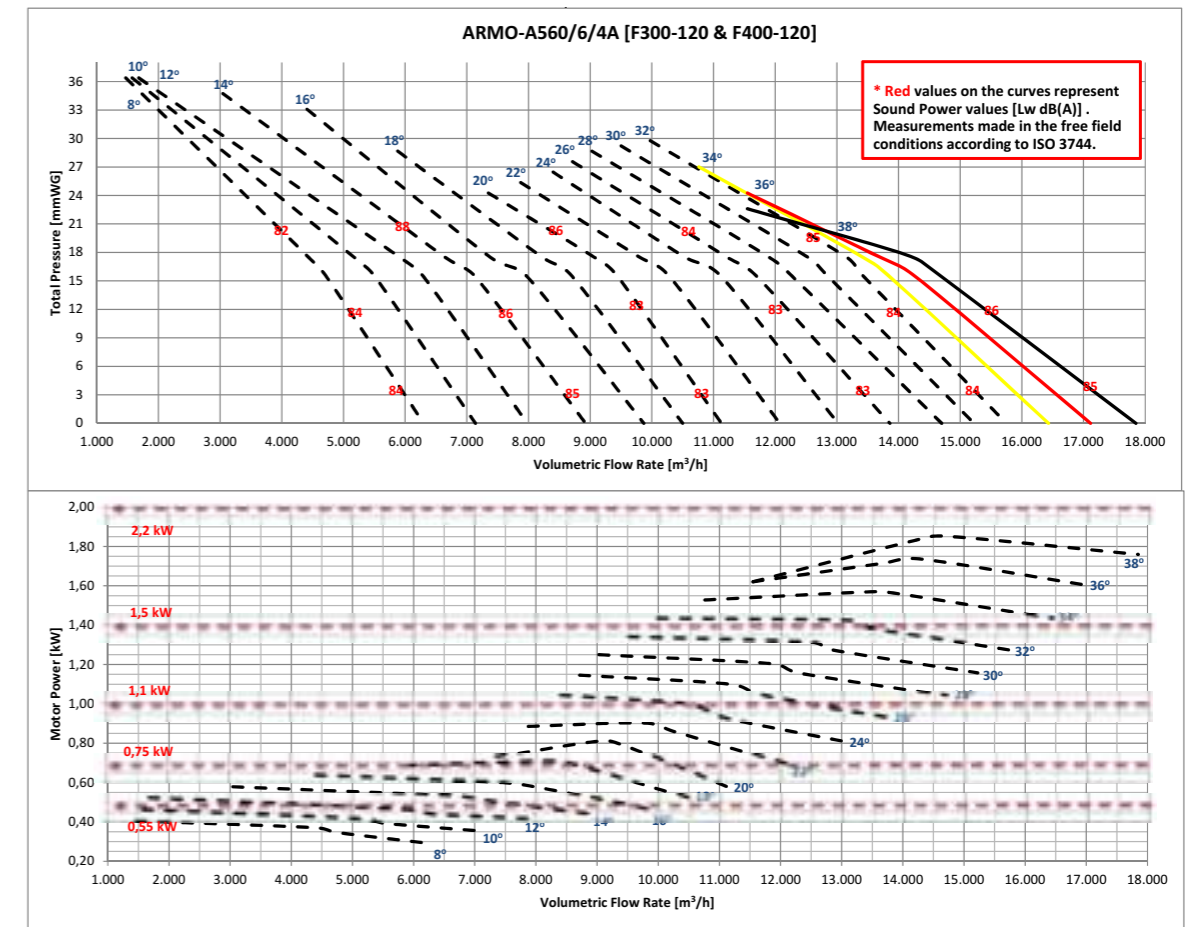
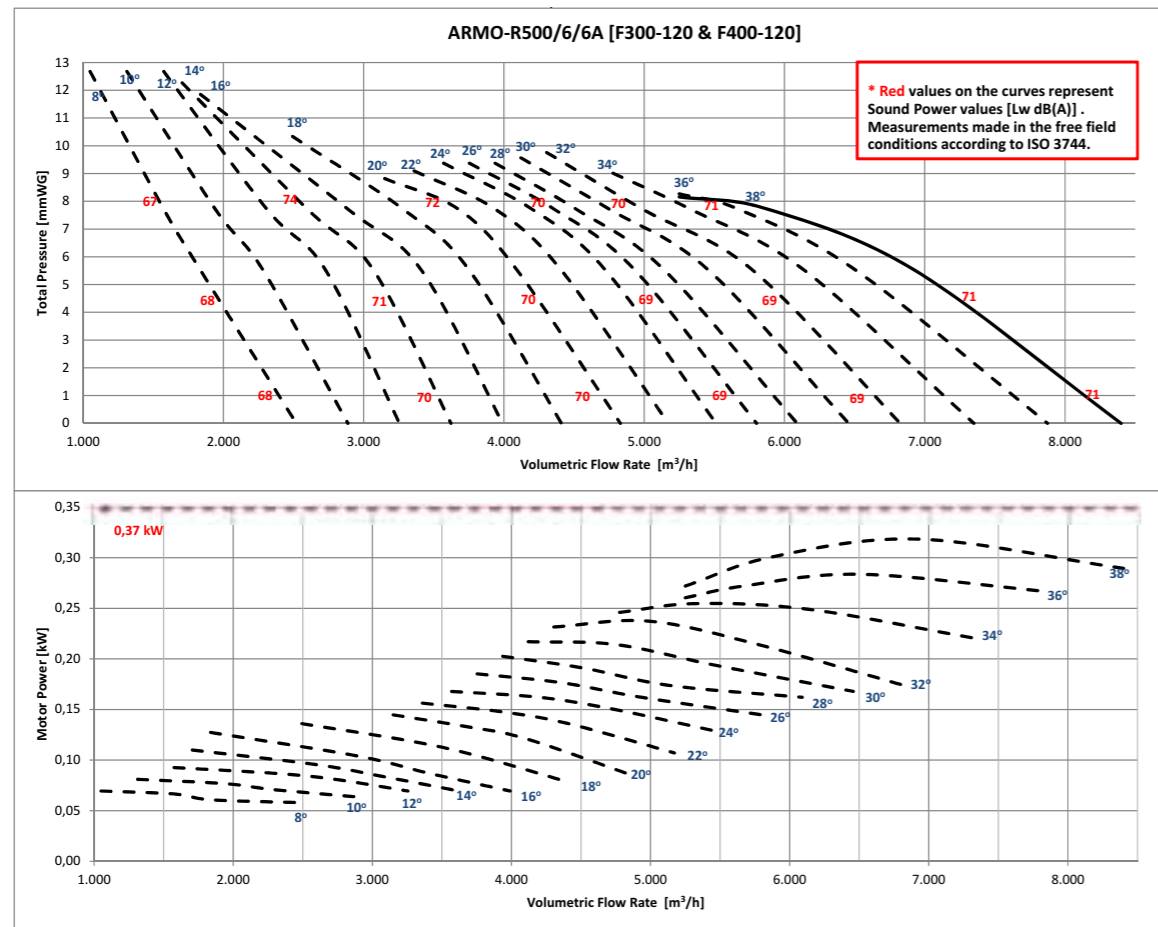

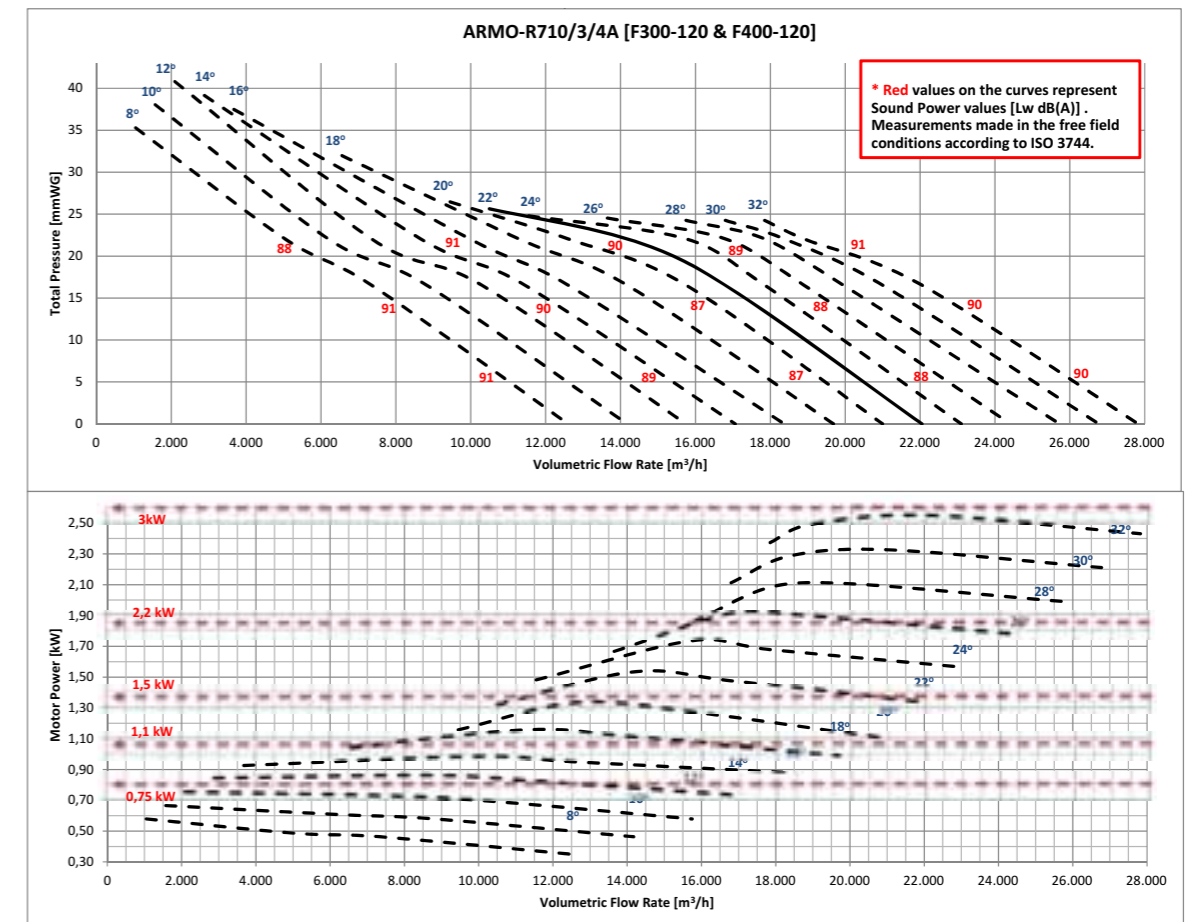
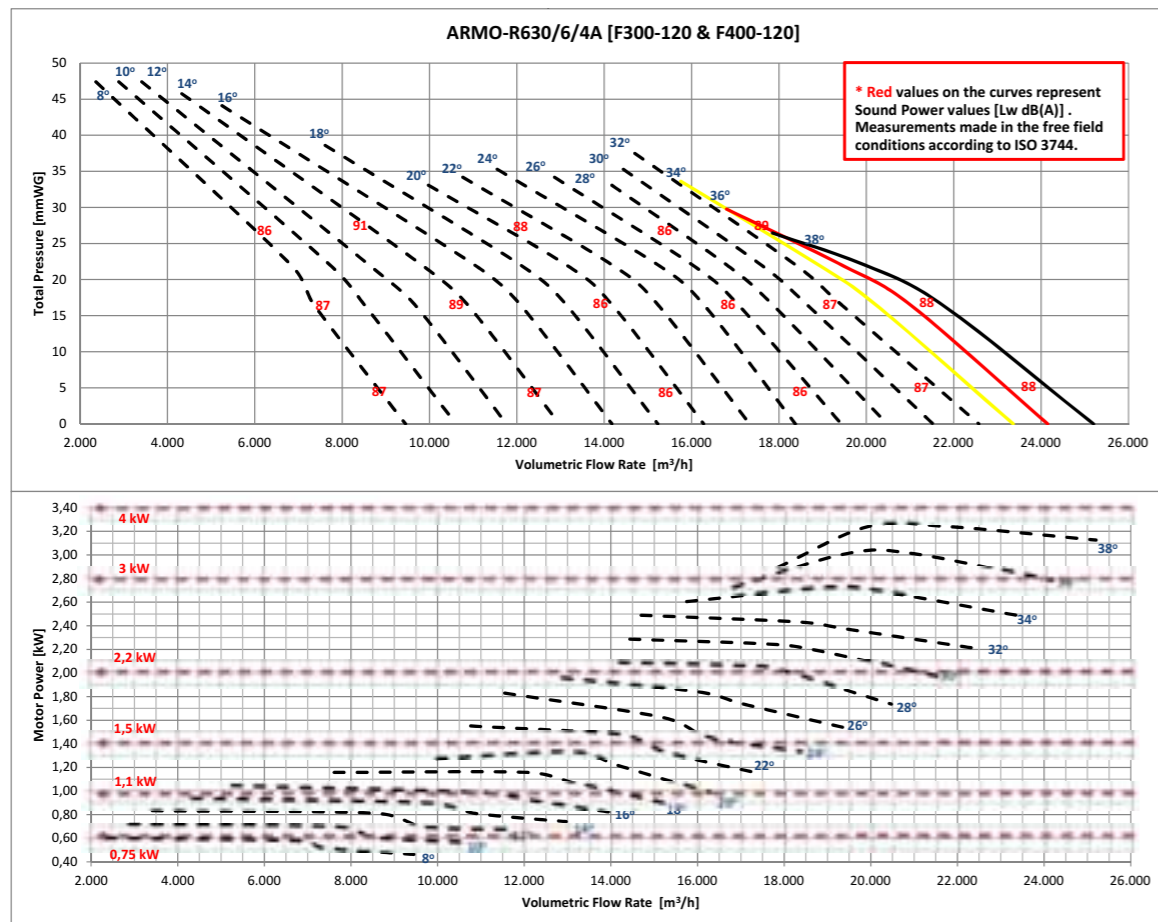
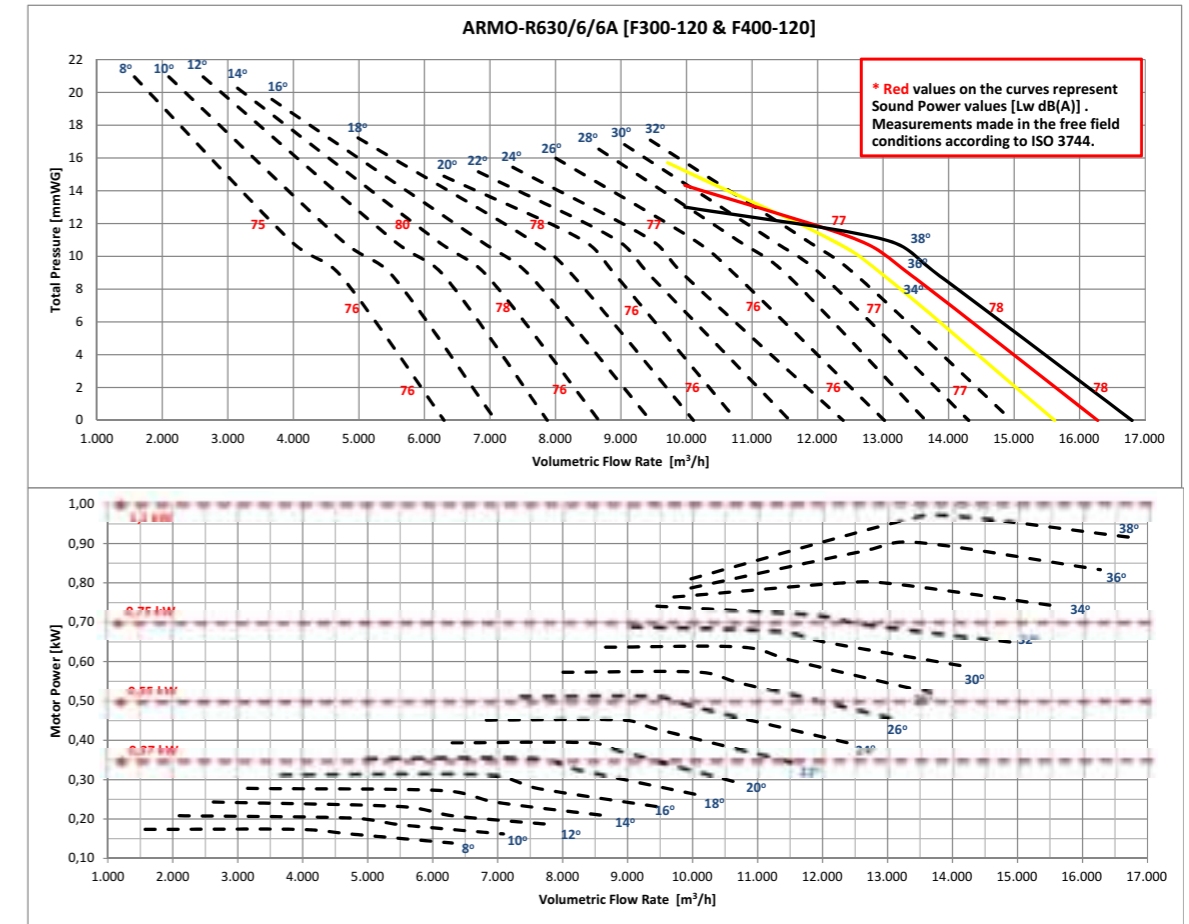
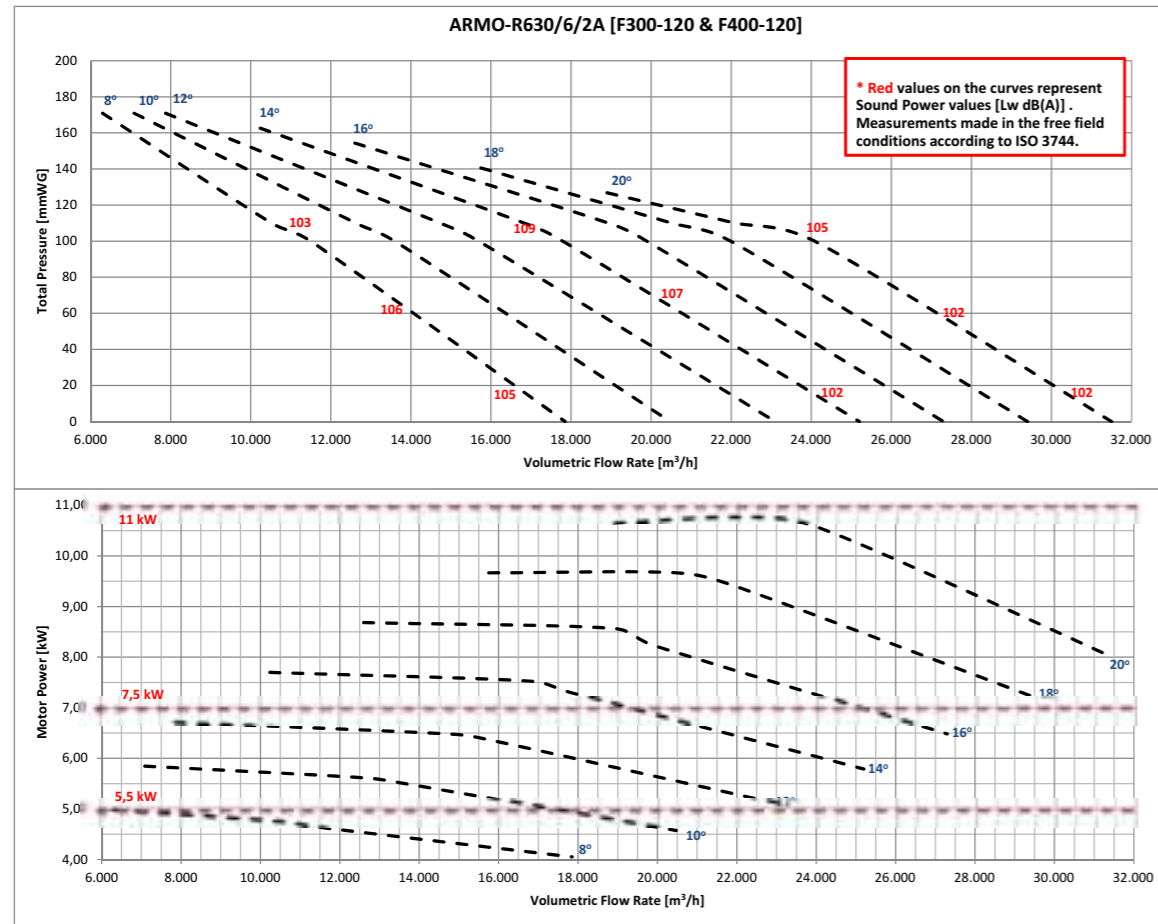

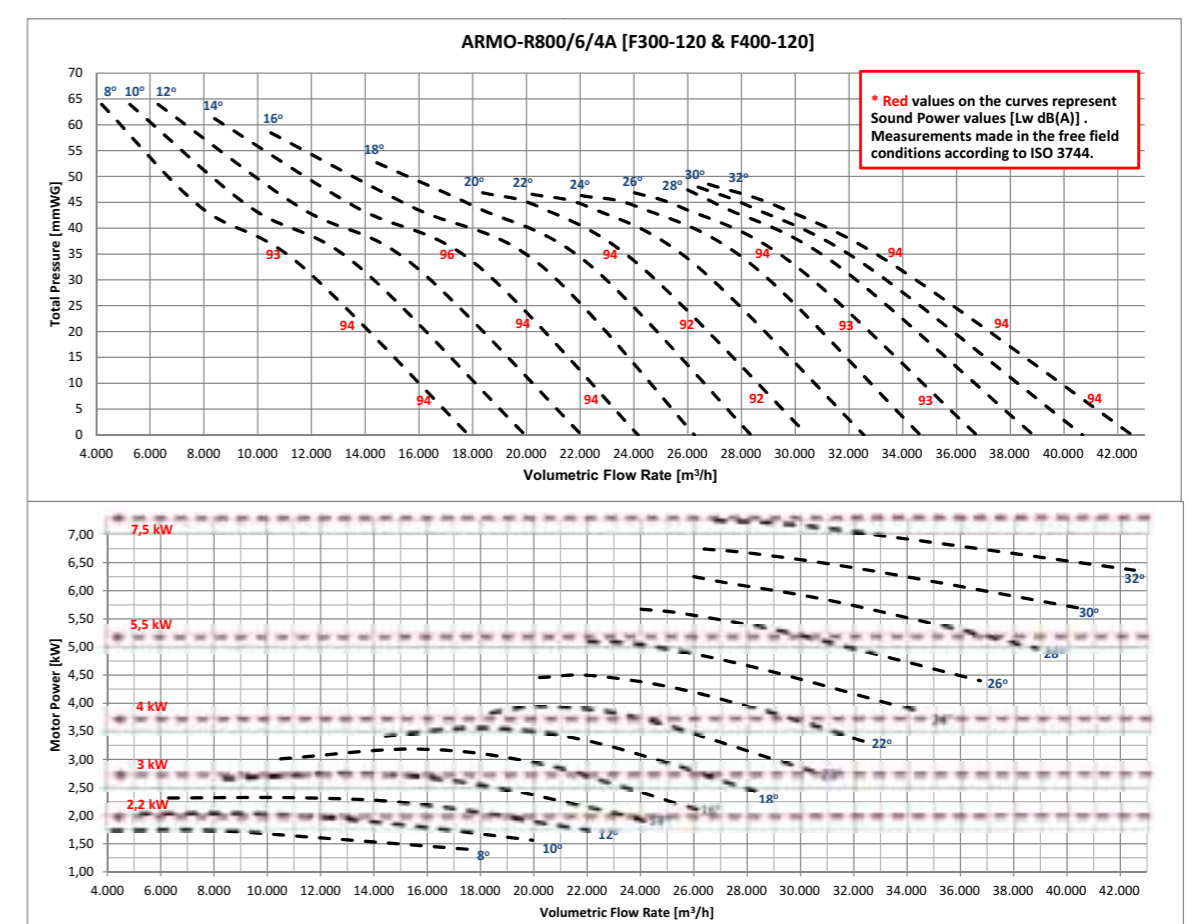
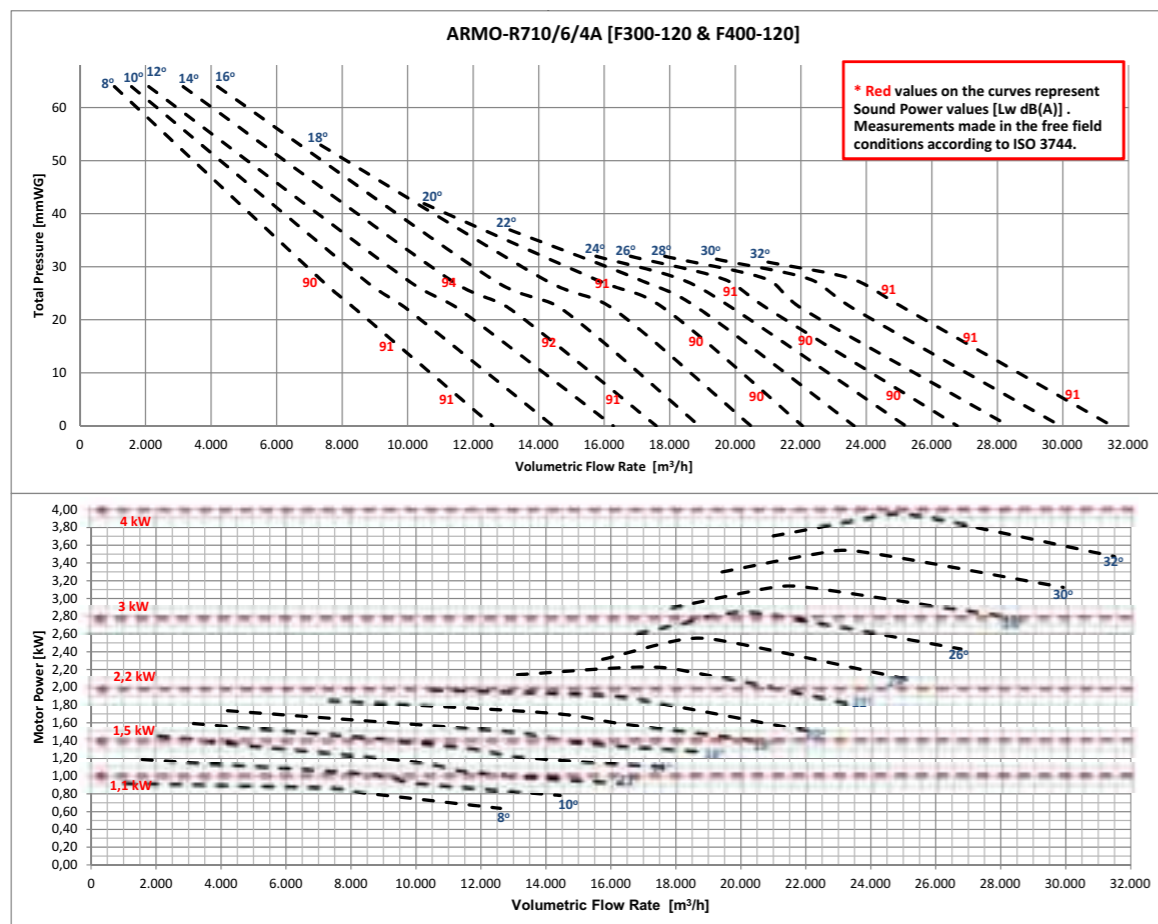
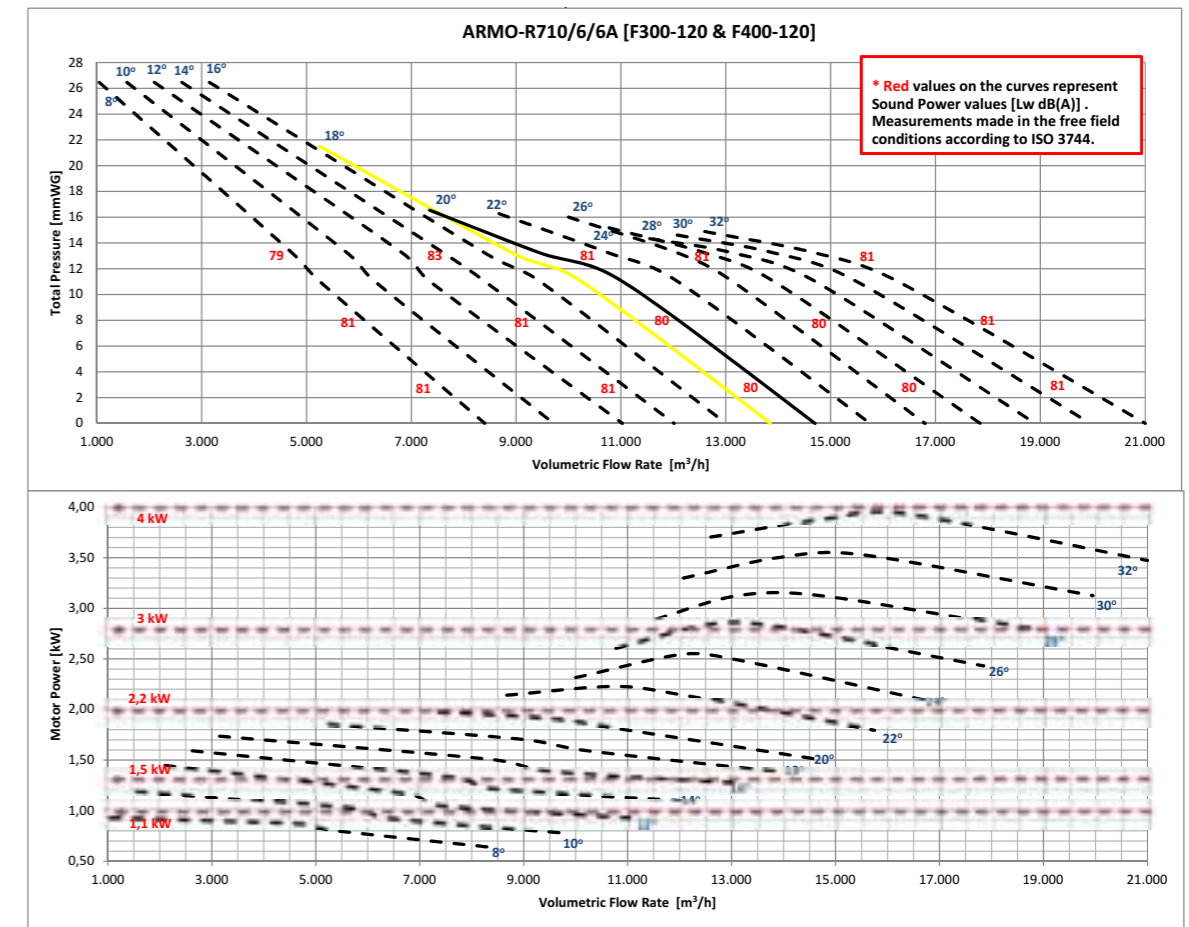
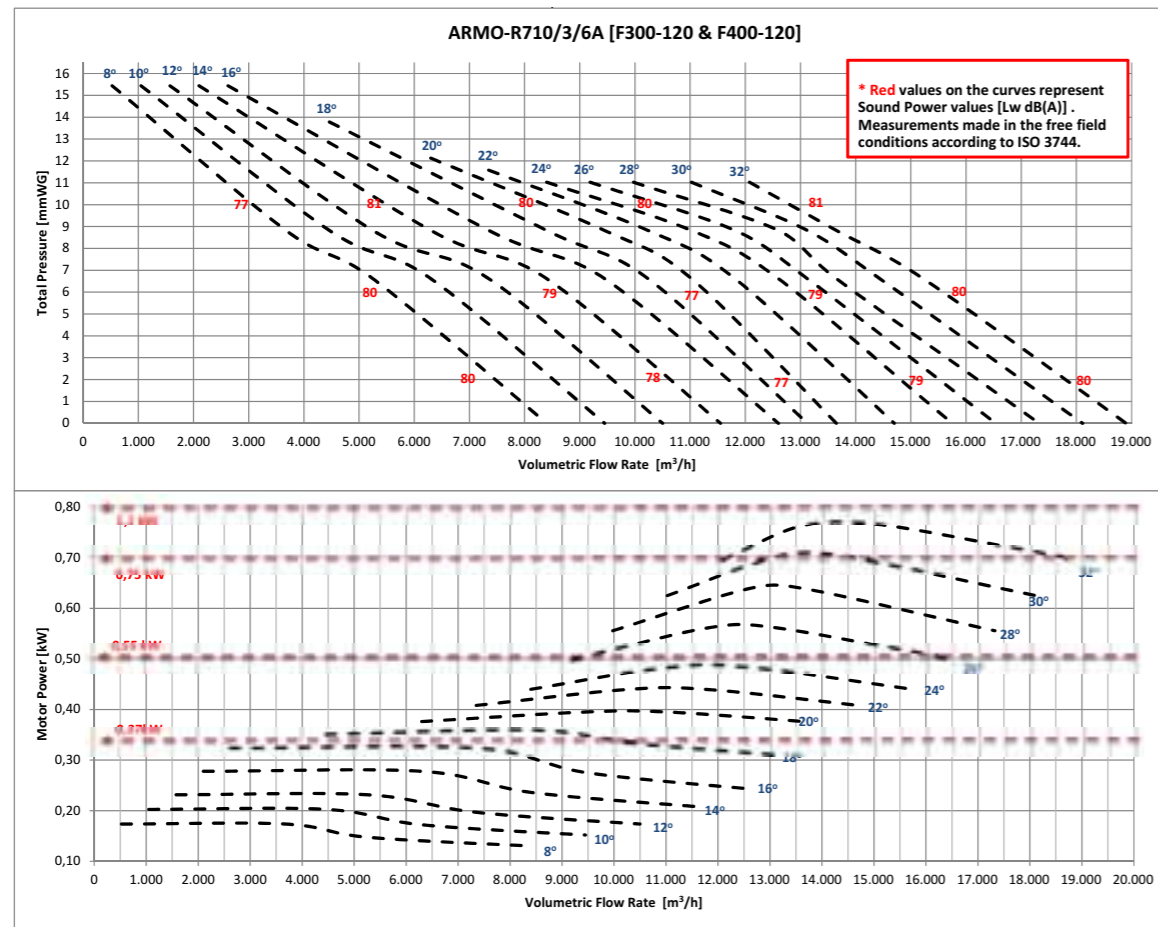

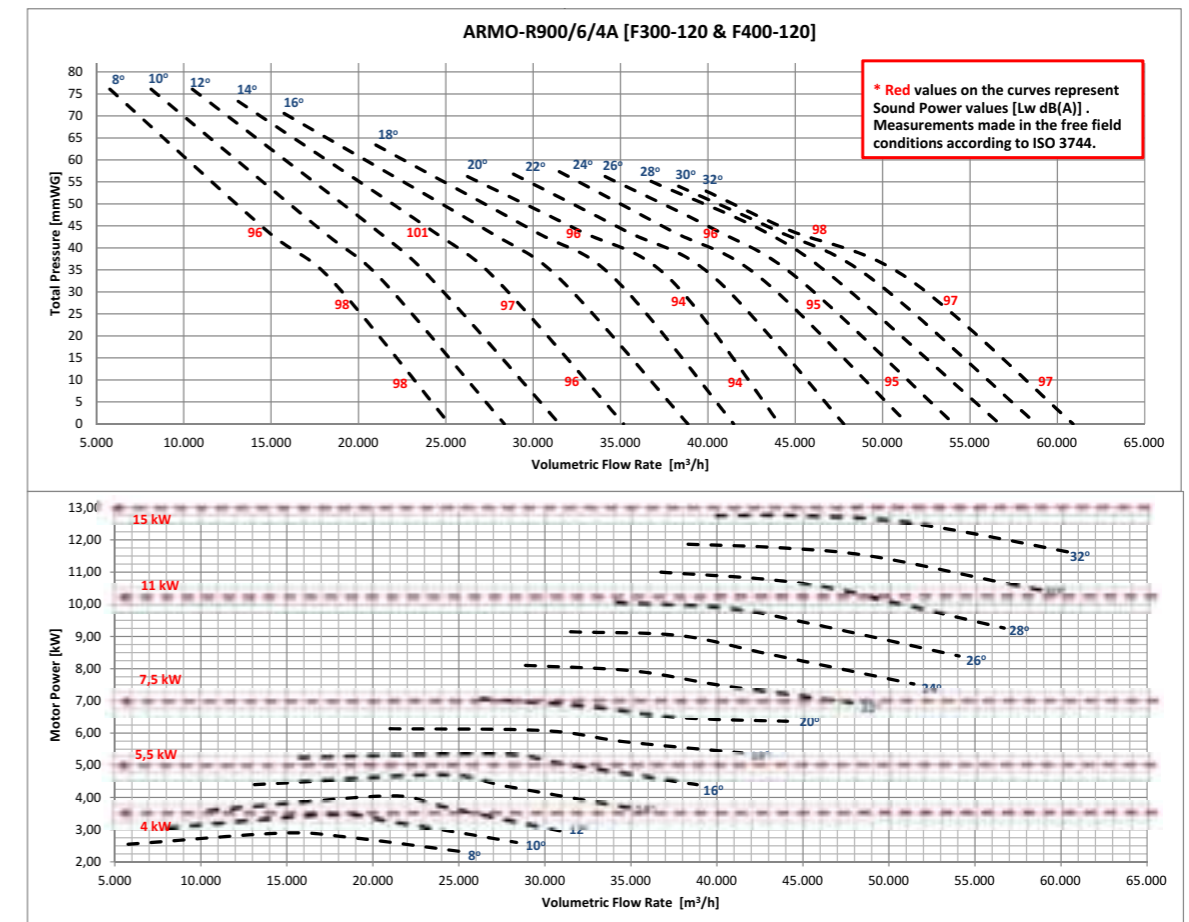
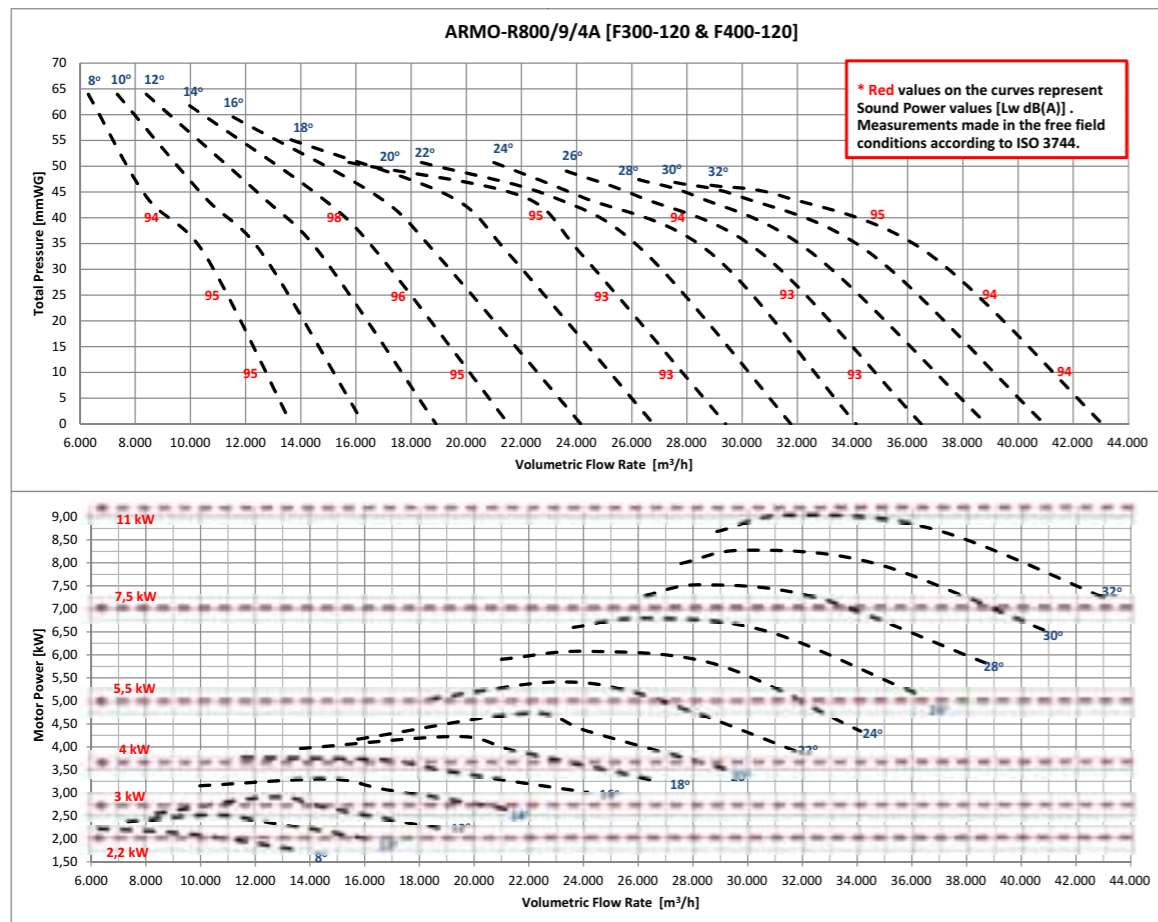
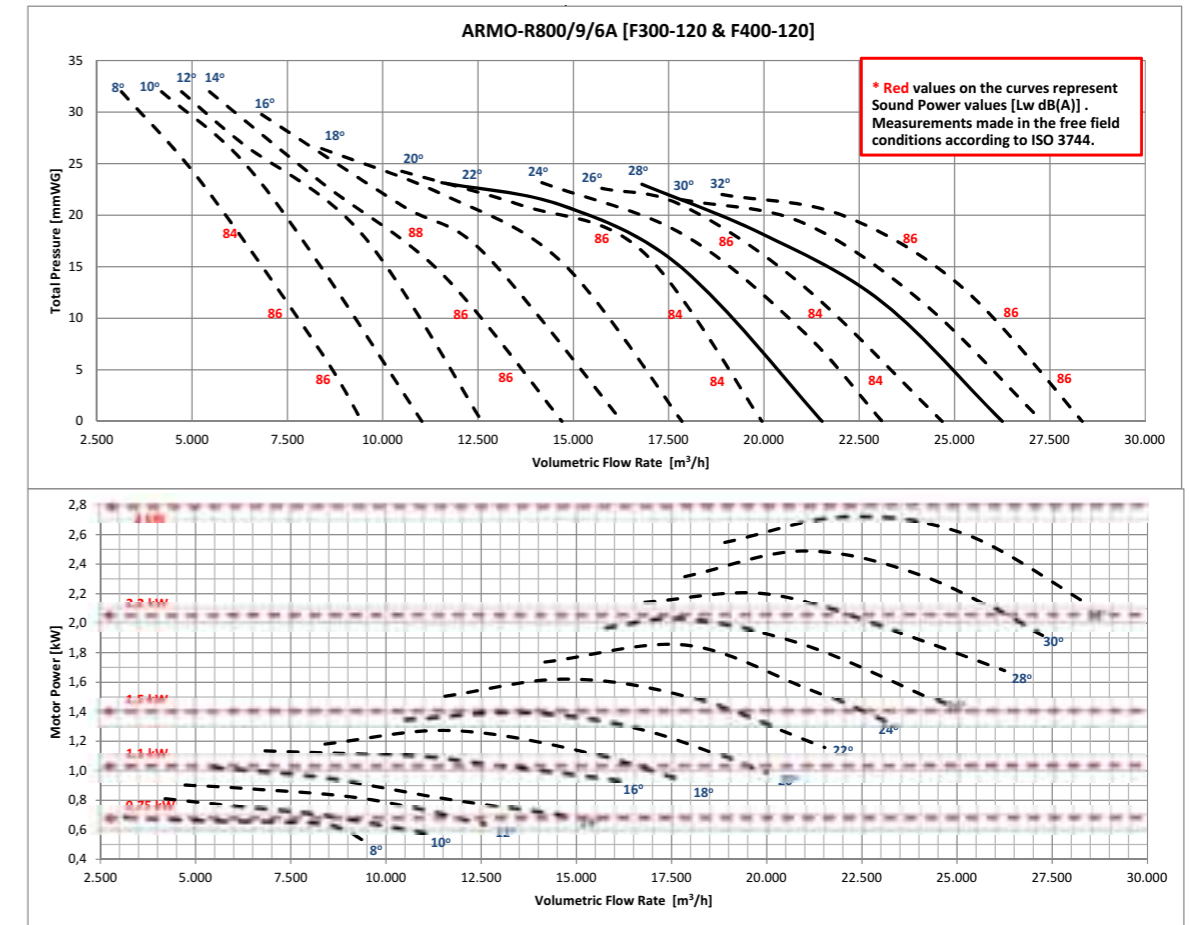
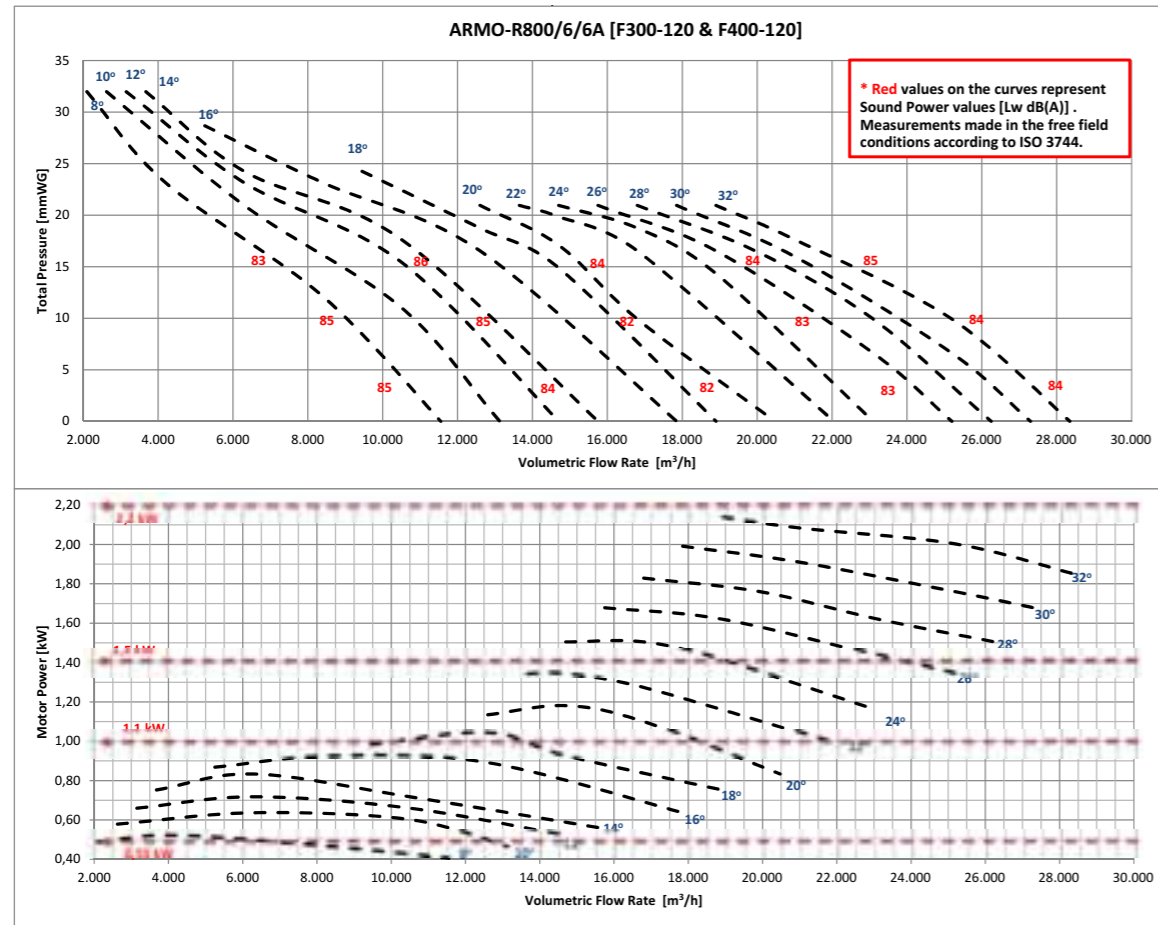

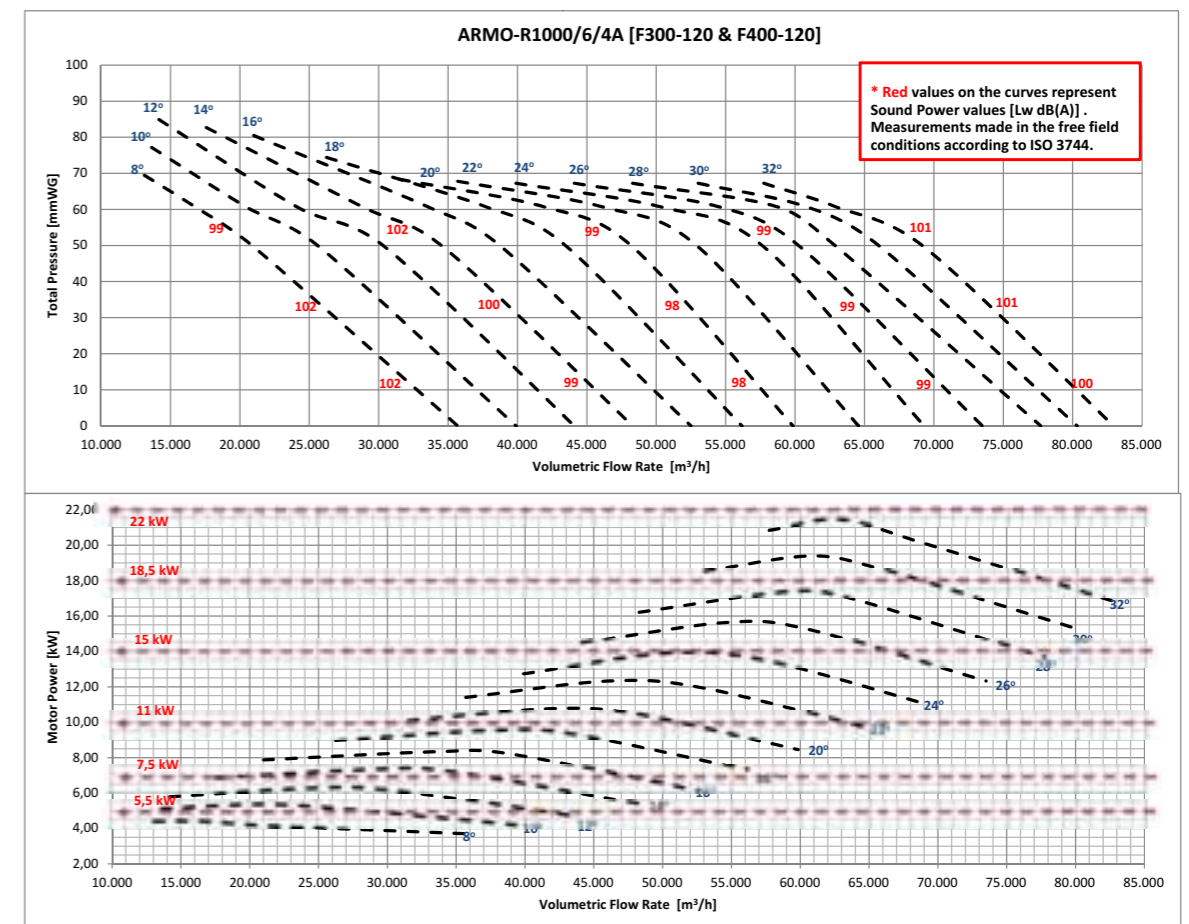
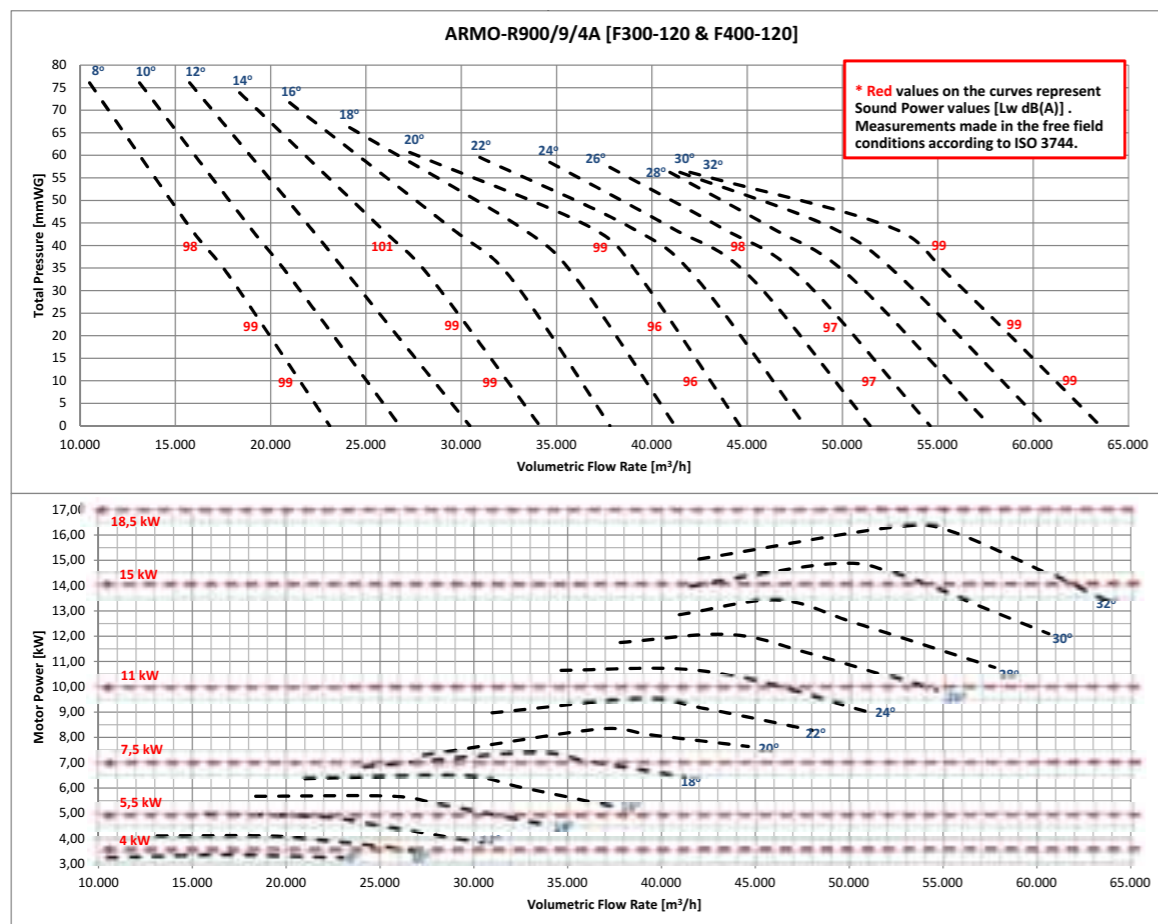
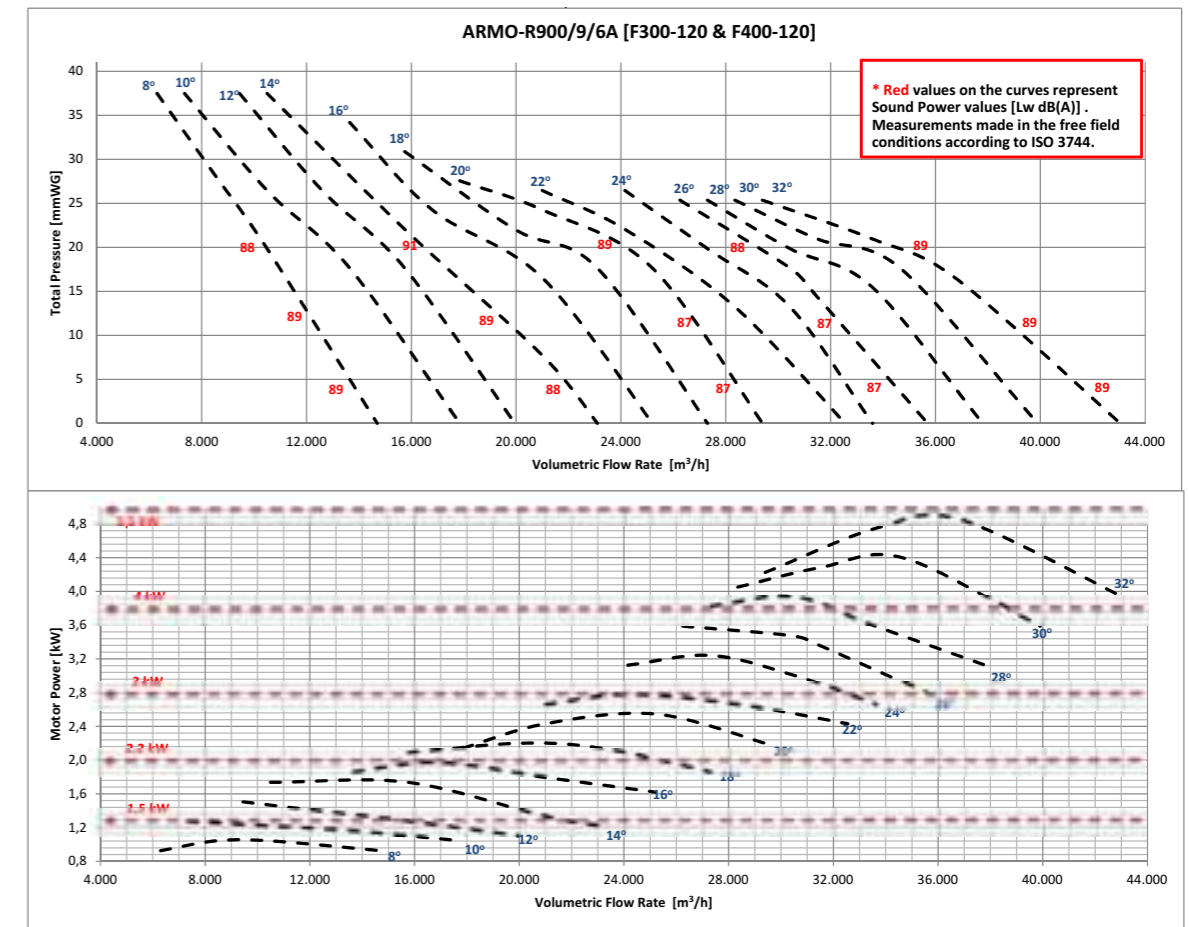
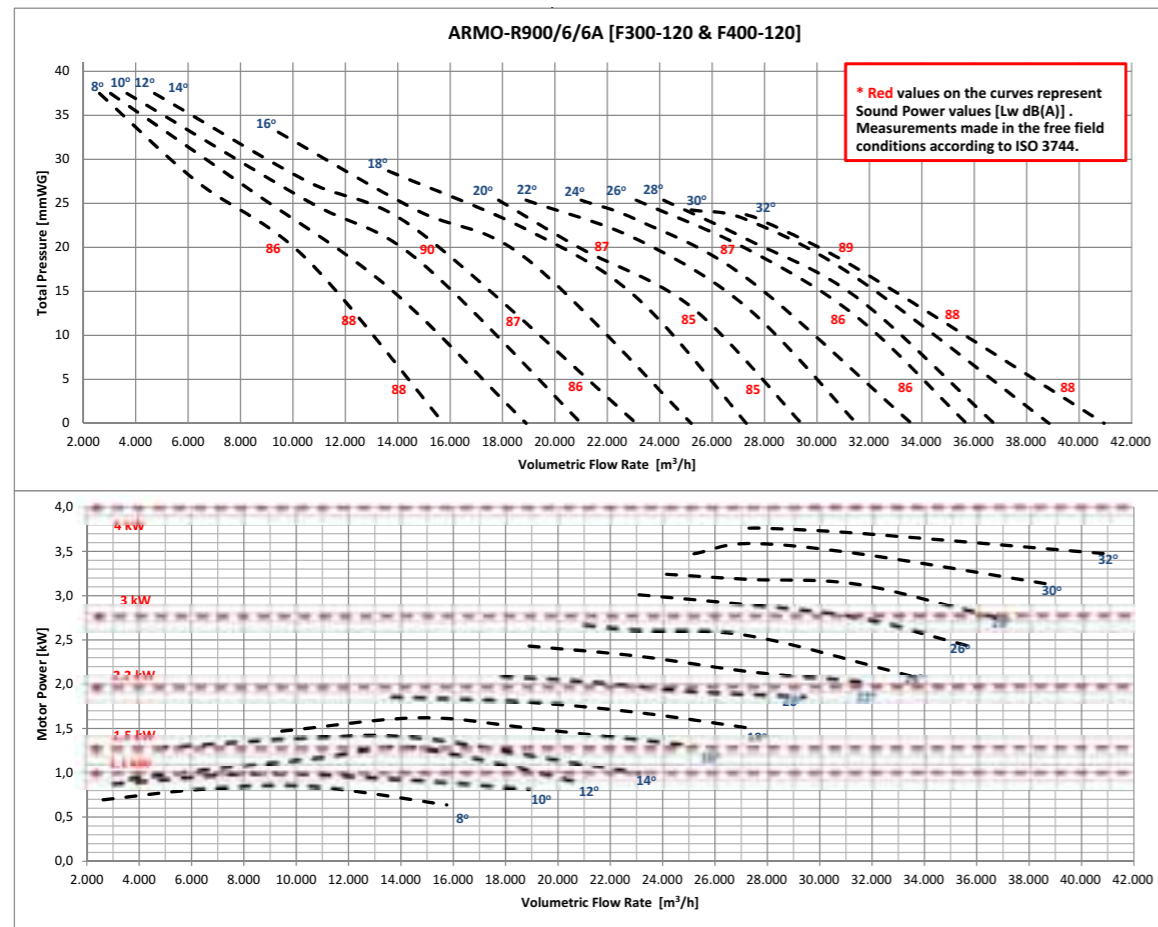

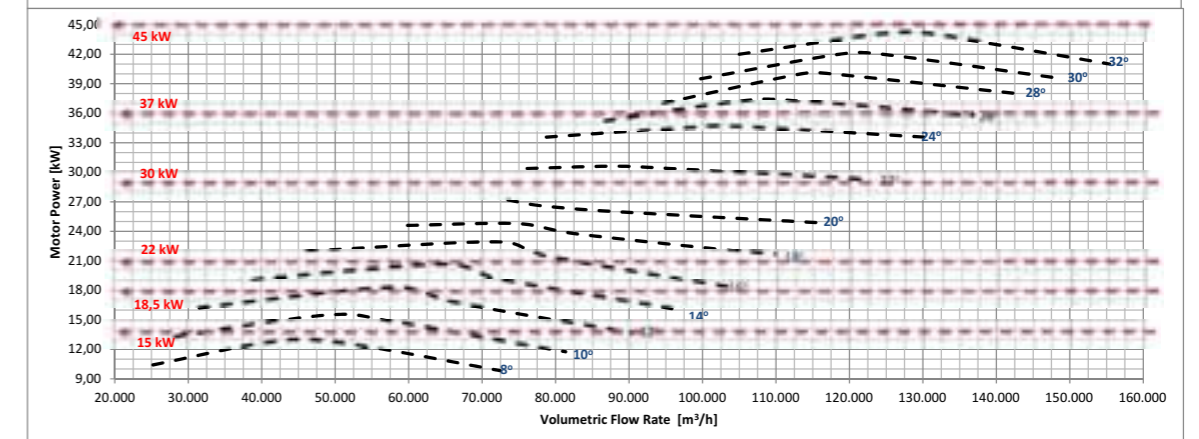
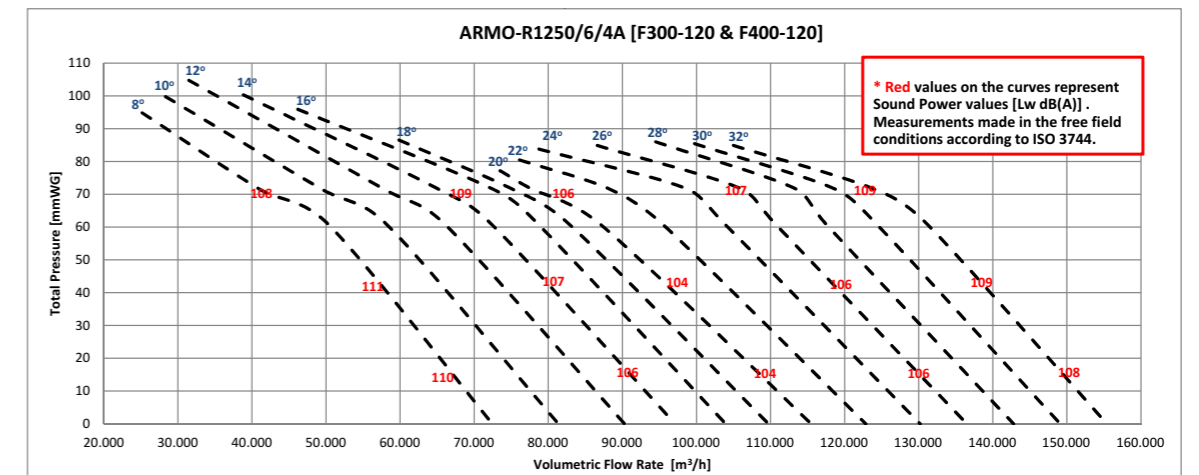
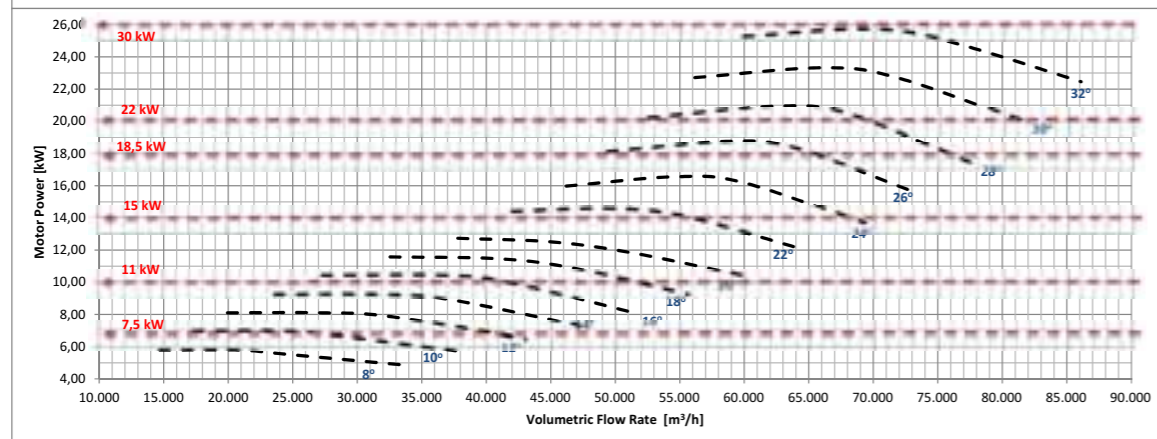
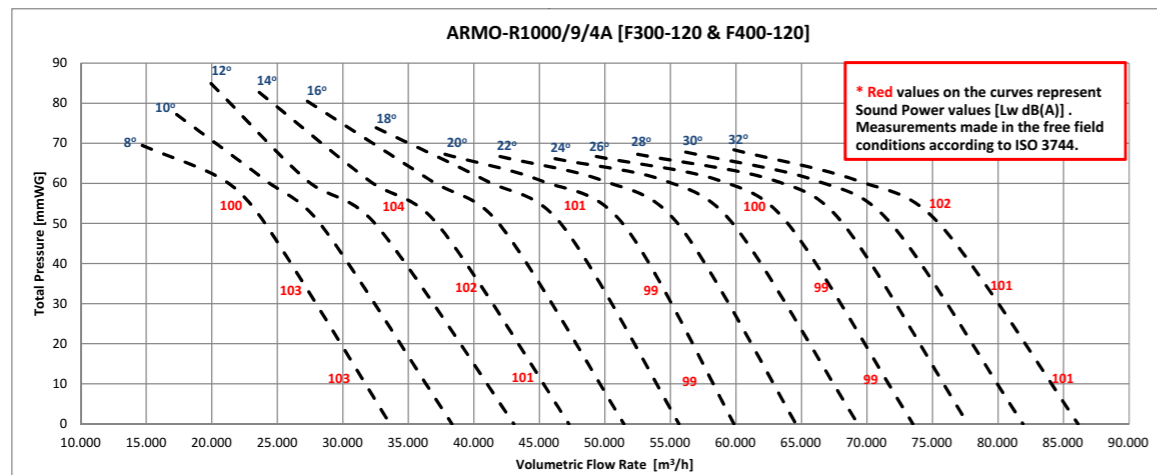
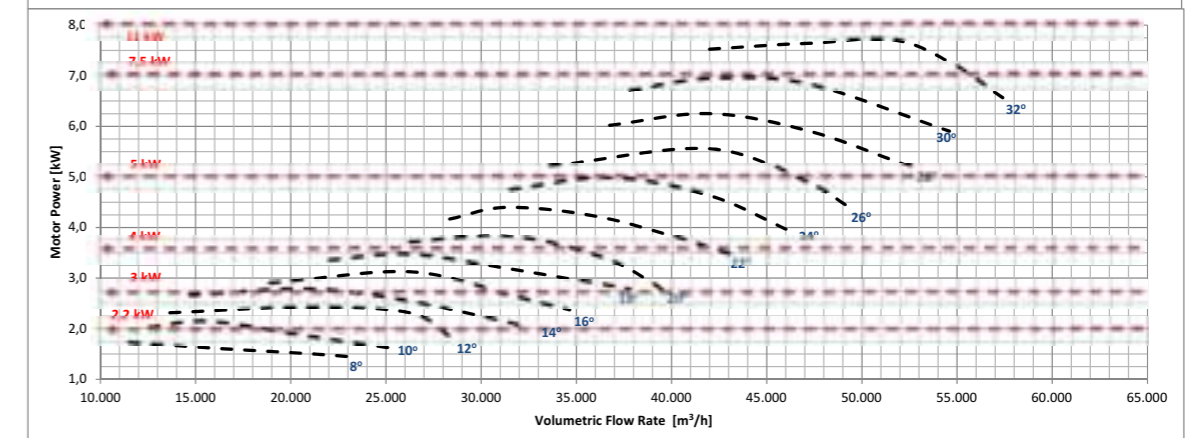
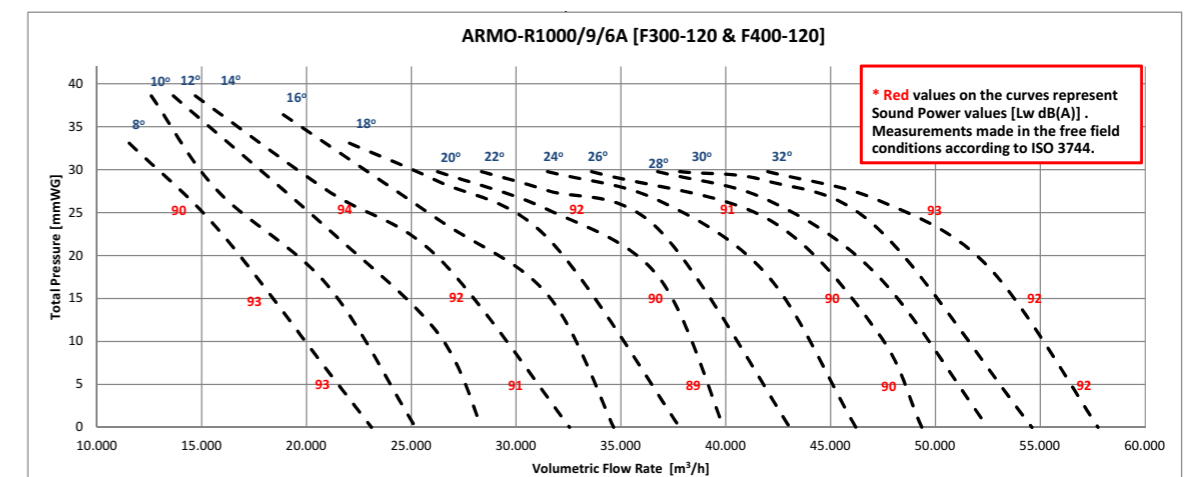
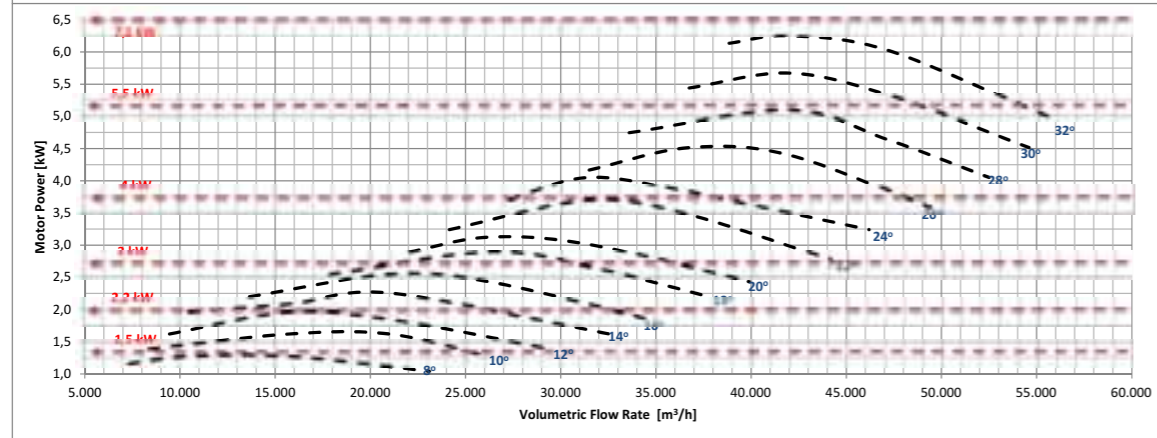
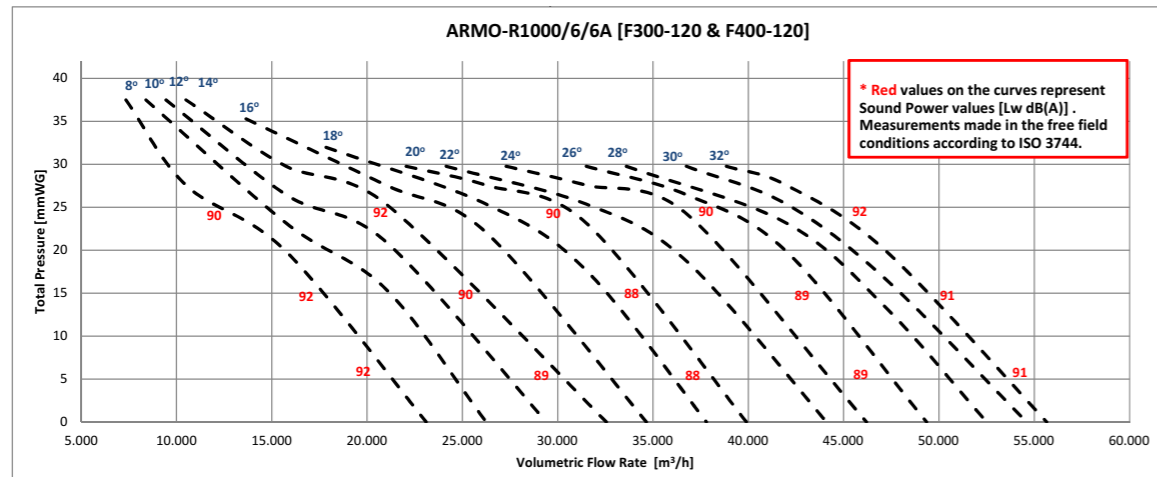

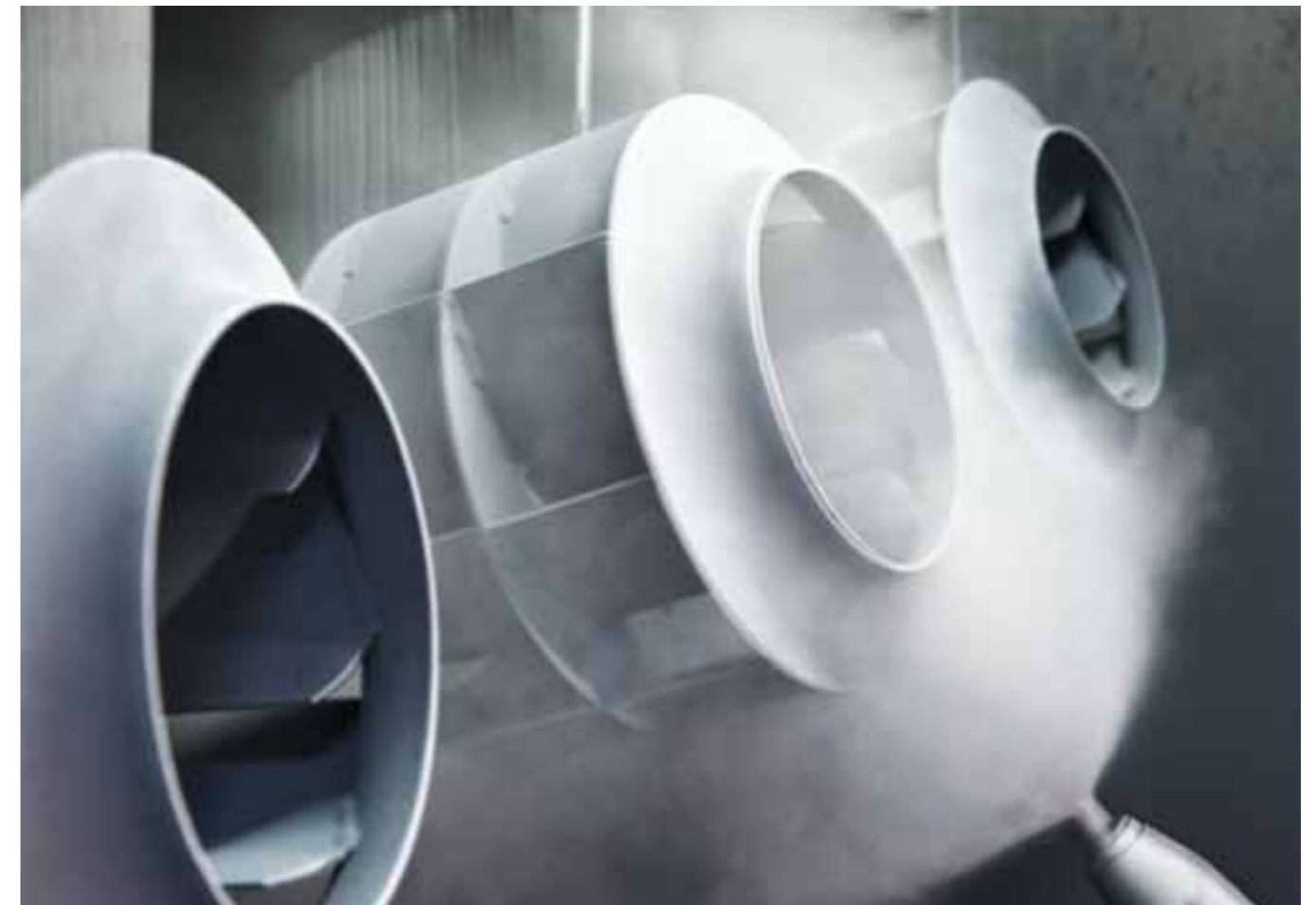
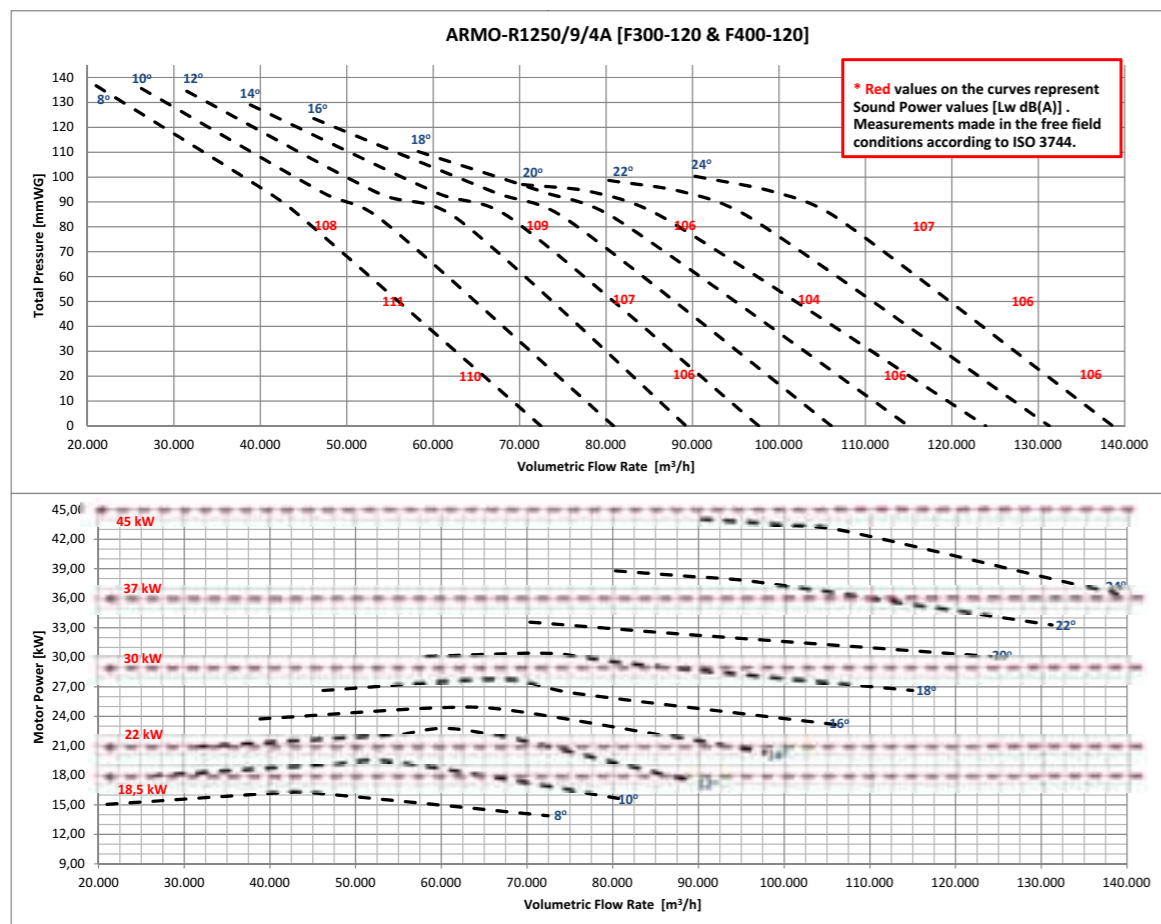
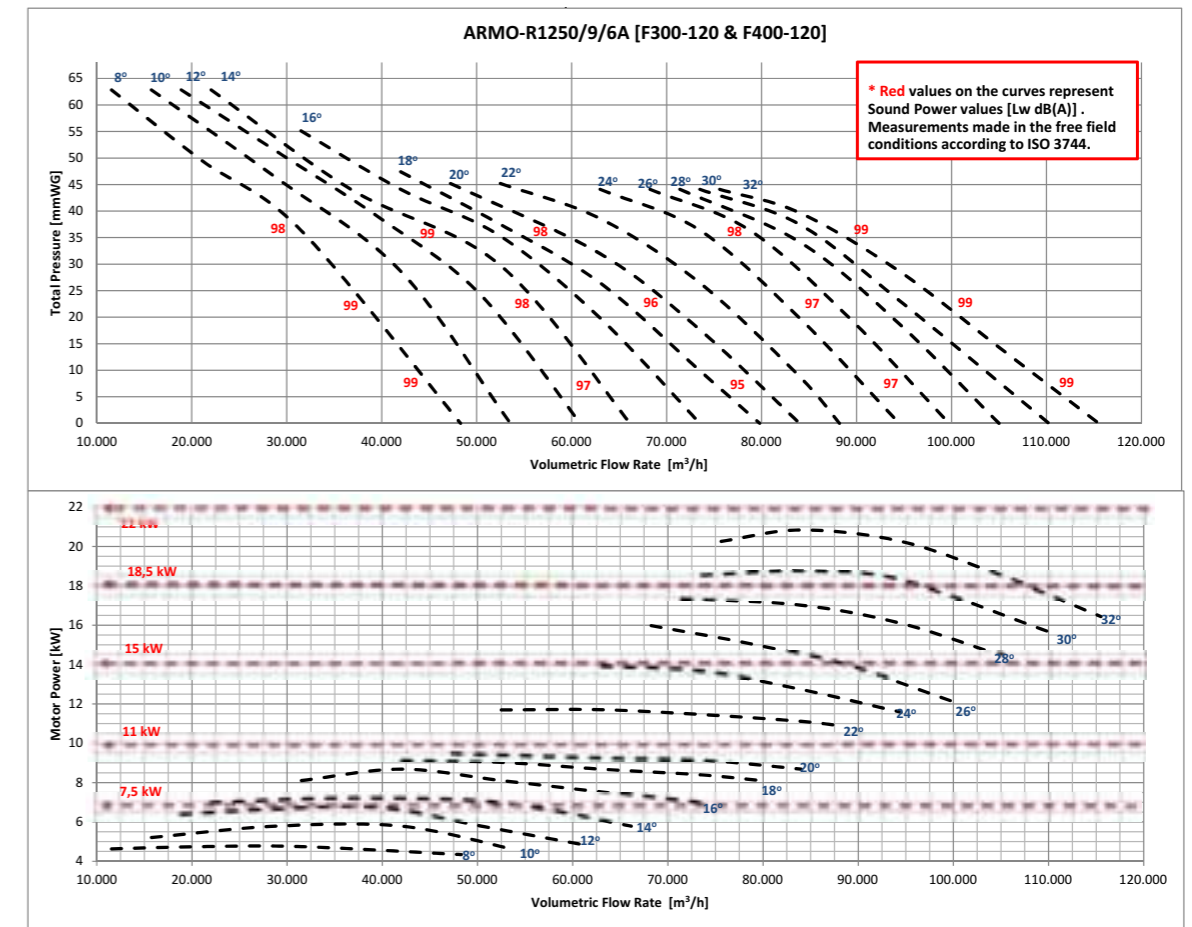
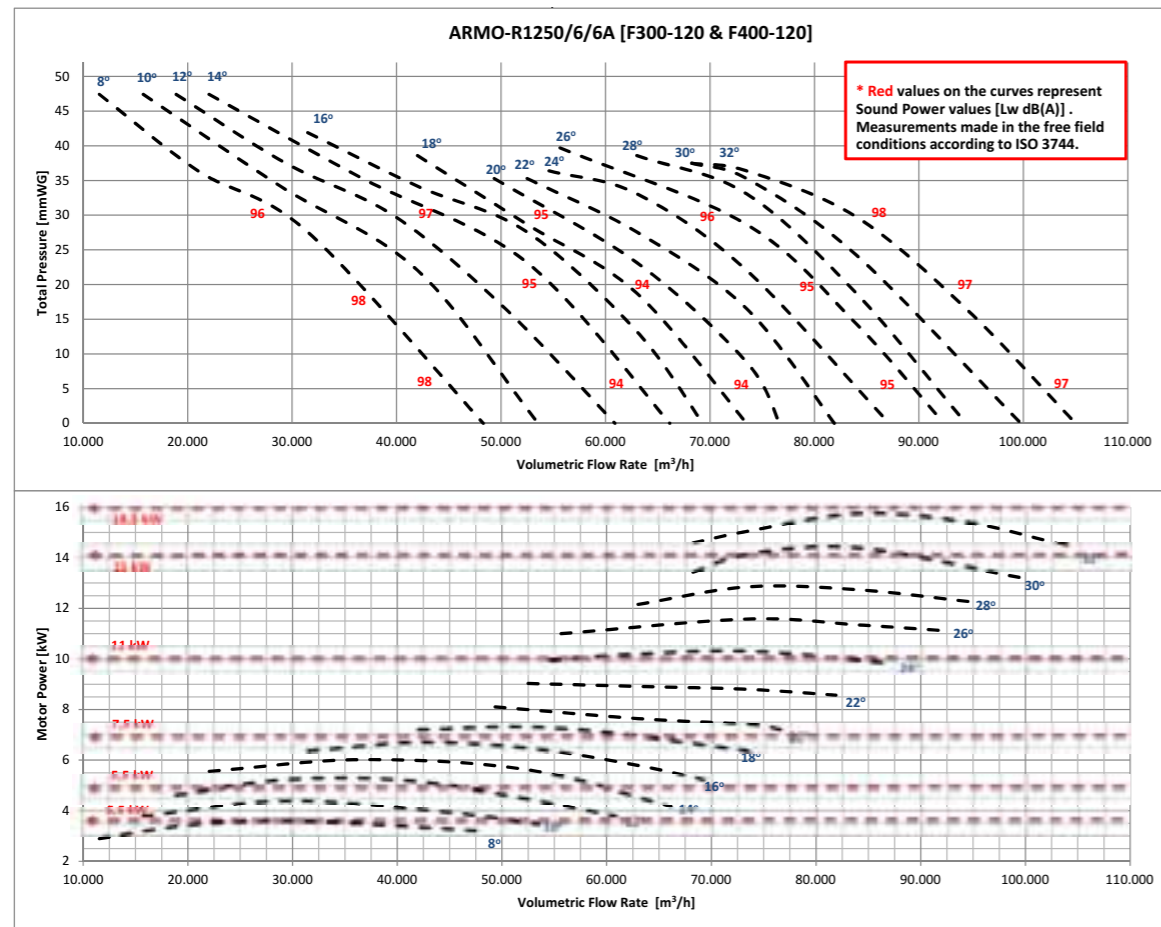



BKEF-R

KITCHEN EXHAUST FANS / Backward Curved

Fan Components and Material Properties

The double-walled body with heat and sound insulation is manufactured from galvanized sheet metal. The fan of the Bkef-R 400 is made of high quality galvanized steel which is resistant to corrosion. The fans of the Bkef-r 450-500-560 models are made of aluminum sheet. All models use an asynchronous motor and the motor is out of airflow. The device is capable of carrying air at max.120°C.

Fan Structure

The fan blades are aerodynamically curved and provide regular flow. The fans are composed of backward sloping and infrequently arranged fins.

*Filtered applications are optional. Please contact BVN representatives.

Benefits

Since the motor is out of airflow, it is resistant to high temperature. The opening cover allows for effortless maintenance of the product. Right-left-top can be changed in three different ways. Water drainage feature. They work quietly thanks to isolation. Speed can be adjusted with speed control devices.

Speed Control

Optional control devices can be provided. Speed control can be done with frequency inverter in 3 ~ phase products. (see BSC-F accessory)

Usage Areas

They are used for smoke evacuation with grease trap filter in dense oily environments such as restaurant kitchens. It is able to carry air at higher temperatures due to the motor being out of airflow.

Technical Drawing and Tables

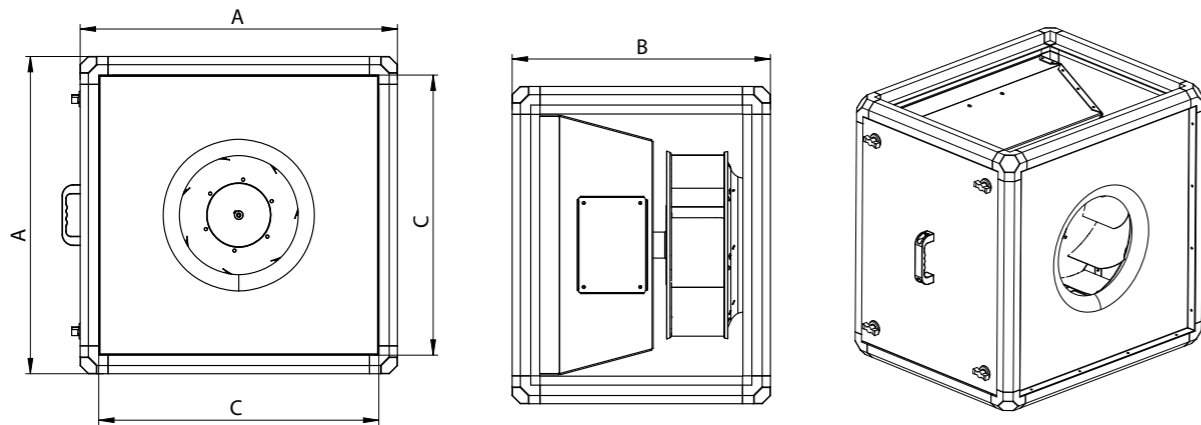

TYPE	A	B	C
BKEF-R 400	683	556	603
BKEF-R 450	683	572	603
BKEF-R 500	683	623	603
BKEF-R 560	813	690	733

Dimensions are in (mm)

TYPE	VOLTAGE	FREQUENCY	POWER	CURRENT	CAPACITOR	SPEED	AIR FLOW	SOUND PRESSURE	INSULATION CLASS	PROTECTION CLASS	WEIGHT
	V	Hz	kW	(A)	(µF)	r.p.m	m ³ /h	dB(A)	Ins.cl.	IP	kg
BKEF-R 400M	230	50	0,37	3,4	15	1390	4100	45	F	55	52
BKEF-R 450M	230	50	0,55	4,5	20	1365	5400	48	F	55	65
BKEF-R 500M	230	50	1,1	7,5	35	1410	8200	52	F	55	77
BKEF-R 560M	230	50	2,2	14,2	50	1420	10800	55	F	55	95
BKEF-R 400T	380	50	0,37	1,2	-	1390	4100	45	F	55	52
BKEF-R 450T	380	50	0,55	1,6	-	1365	5400	48	F	55	65
BKEF-R 500T	380	50	1,1	2,6	-	1410	8200	52	F	55	77
BKEF-R 560T	380	50	2,2	4,9	-	1420	10800	55	F	55	95

Sound Level Measured from 3m distance in room condition.

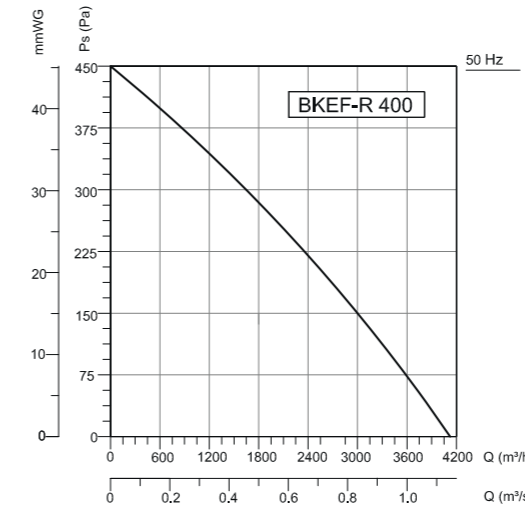

Frequency	Tot	63	125	250	500	1000	2000	4000	8000 Hz
L _{wa} Inlet	68	55	57	61	63	62	59	54	47 dB(A)
L _{wa} Outlet	70	57	59	63	65	64	61	56	49 dB(A)
L _{wa} Surrounding	52	39	41	45	47	46	43	38	31 dB(A)

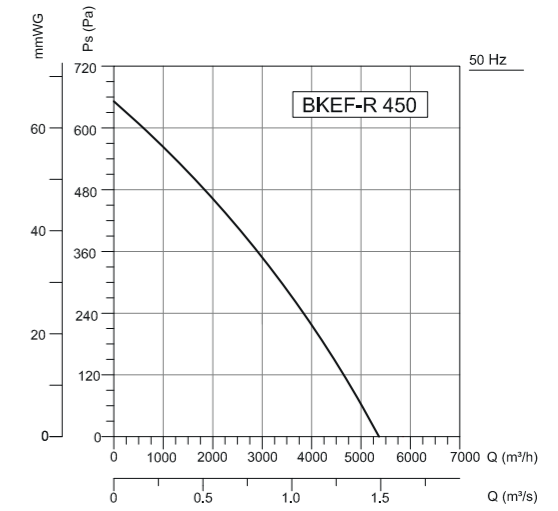

Frequency	Tot	63	125	250	500	1000	2000	4000	8000 Hz
L _{wa} Inlet	70	57	59	63	65	64	61	46	49 dB(A)
L _{wa} Outlet	72	59	61	65	67	66	63	58	51 dB(A)
L _{wa} Surrounding	55	42	44	48	50	49	46	41	34 dB(A)

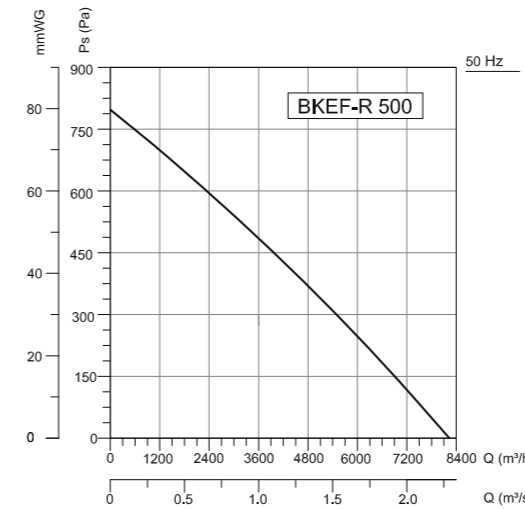

Frequency	Tot	63	125	250	500	1000	2000	4000	8000 Hz
L _{wa} Inlet	74	61	63	67	69	68	65	60	53 dB(A)
L _{wa} Outlet	76	63	65	69	71	70	67	62	55 dB(A)
L _{wa} Surrounding	59	46	48	52	54	53	50	45	38 dB(A)

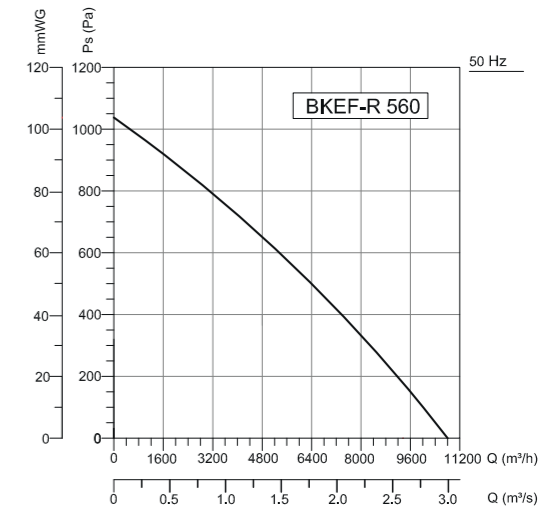

Frequency	Tot	63	125	250	500	1000	2000	4000	8000 Hz
L _{wa} Inlet	76	63	65	69	71	70	67	62	55 dB(A)
L _{wa} Outlet	77	67	66	70	71	71	68	63	56 dB(A)
L _{wa} Surrounding	62	50	52	55	57	56	49	53	42 dB(A)

Accessories





BKEF-RH

KITCHEN EXHAUST FANS / Backward Curved - High Pressure

Fan Components and Material Properties

The double-walled body with heat and sound insulation is manufactured from galvanized sheet metal. 25 mm thick mineral wool was applied for sound and heat insulation. All models of the fan can be removed and installed. All models use asynchronous motor and the motor is out of airflow. The device is capable of carrying air at max.120°C.

Fan Structure

Electrostatic painted and welded plug fan is used. The fan blades are aerodynamically curved and provide regular flow. It is suitable to operate at high speed as it uses a welded plug fan.

*Filtered applications are optional. Please contact BVN representatives.

Benefits

Since the motor is out of airflow, it is resistant to high temperature. It has high performance and high efficiency because it works at high speed. Thanks to the removable panels, smoke can be easily steered. Right-left-top can be changed in three different ways. Water drainage feature. They work quietly thanks to isolation. Occasionally requires wheel cleaning. Speed can be adjusted with speed control devices.

Usage Areas

In restaurants with dense oil like greaseproof environments, it is possible to use commercially available commercial kitchen etc. with smoke trap and long channel distance. Used in environments. It is able to carry air at higher temperatures due to the motor being out of airflow.

Technical Drawing and Tables

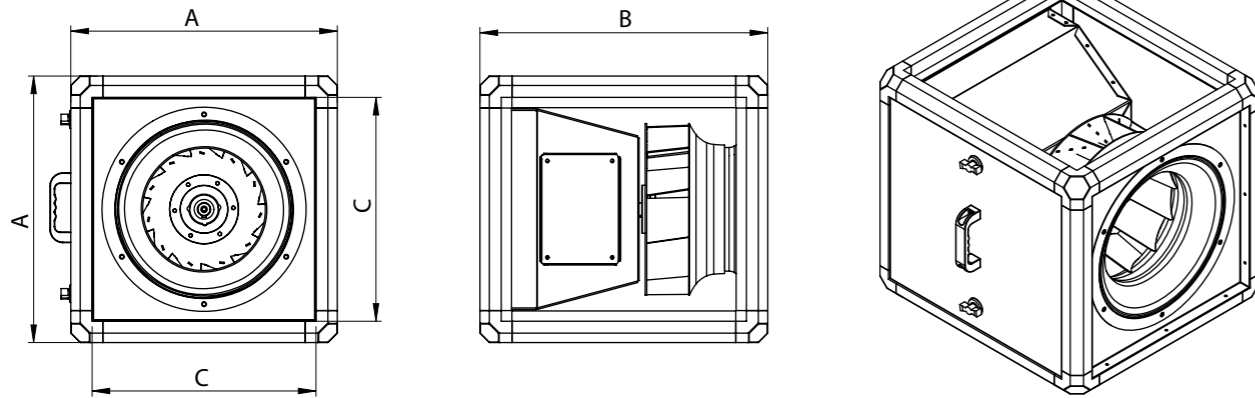

TYPE	A	B	C
BKEF-RH 280	500	500	420
BKEF-RH 315	500	540	420

Dimensions are in (mm)

TYPE	VOLTAGE	FREQUENCY	POWER	CURRENT	CAPACITOR	SPEED	AIR FLOW	SOUND PRESSURE	INSULATION CLASS	PROTECTION CLASS	WEIGHT
	V	Hz	kW	(A)	(µF)	r.p.m	m ³ /h	dB(A)	Ins.cl.	IP	kg
BKEF-RH 280M	230	50	0,75	5	30	2840	3600	65	F	55	38
BKEF-RH 315M	230	50	1,5	9,8	40	2865	5000	68	F	55	41
BKEF-RH 280T	380	50	0,75	1,8	-	2840	3600	65	F	55	38
BKEF-RH 315T	380	50	1,5	3,3	-	2865	5000	68	F	55	41

Sound Level Measured from 3m distance in room condition.

Accessories

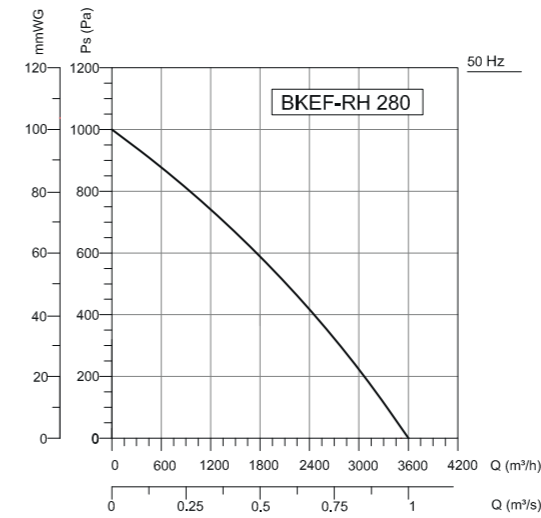

Frequency	Tot	63	125	250	500	1000	2000	4000	8000	Hz
L _{WA} Inlet	86	72	74	78	80	79	76	71	74	dB(A)
L _{WA} Outlet	86	76	75	79	80	80	77	72	65	dB(A)
L _{WA} Surrounding	71	59	61	64	66	65	58	62	51	dB(A)

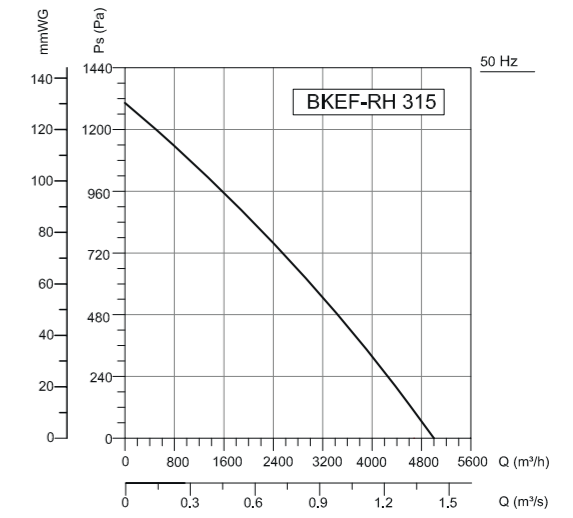

Frequency	Tot	63	125	250	500	1000	2000	4000	8000	Hz
L _{WA} Inlet	90	76	78	82	84	84	80	75	68	dB(A)
L _{WA} Outlet	90	80	79	83	84	84	82	76	69	dB(A)
L _{WA} Surrounding	75	63	65	68	70	69	62	66	55	dB(A)





BKEF

KITCHEN EXHAUST FANS / Backward Curved

Fan Components and Material Properties

The body with heat and sound insulation is manufactured from galvanized sheet metal. The fans of the Bkef 315-355-400 are made of high quality galvanized steel that is resistant to corrosion. The fans of the Bkef 450-500-560 models are made of aluminum sheet. Asynchronous motor is used in all models. The motor is out of airflow. The device is capable of carrying air at max.120°C.

Fan Structure

The fan blades are aerodynamically curved and provide regular flow. The fans are composed of backward sloping and infrequently arranged fins.

Benefits

Since the motor is out of airflow, it is resistant to high temperature. The opening cover allows for effortless maintenance of the product. Water drainage feature. They work quietly thanks to isolation. Speed can be adjusted with speed control devices.

Speed Control

Optional control devices can be provided. Speed control can be done with frequency inverter in 3-phase products. (see BSC-F accessory)

Usage Areas

They are used for smoke evacuation with grease trap filter in dense oily environments such as restaurant kitchens. It is able to carry air at higher temperatures due to the motor being out of airflow.

Technical Drawing and Tables

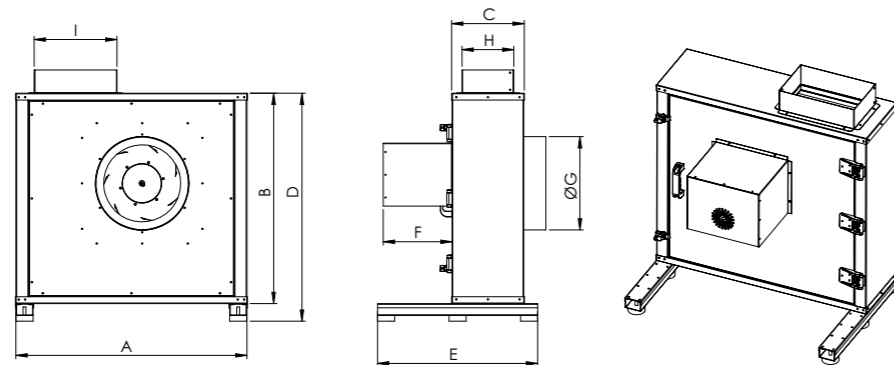

TYPE	A	B	C	D	E	F	G	H	J
BKEF 315	650	605	220	665	480	245	250	160	230
BKEF 355	730	655	230	715	480	245	280	170	260
BKEF 400	815	740	255	800	580	245	330	185	295
BKEF 450	905	810	270	870	580	245	350	210	325
BKEF 500	1005	900	335	990	635	280	400	280	355
BKEF 560	1105	1000	365	1090	715	330	455	310	455

Dimensions are in (mm)

TYPE	VOLTAGE	FREQUENCY	POWER	CURRENT	CAPACITOR	SPEED	AIR FLOW	SOUND PRESSURE	INSULATION CLASS	PROTECTION CLASS	WEIGHT
	V	Hz	kW	(A)	(µF)	r.p.m	m³/h	dB(A)	Ins.cl.	IP	kg
BKEF 315M	230	50	0,25	2,1	10	1390	1800	37-29	F	55	51
BKEF 355M	230	50	0,25	2,1	10	1390	2800	41-33	F	55	63
BKEF 400M	230	50	0,37	3,4	15	1400	4000	42-34	F	55	78
BKEF 450M	230	50	0,55	4,5	20	1410	5200	45-37	F	55	87
BKEF 500M	230	50	1,1	7,5	35	1400	8000	49-42	F	55	120
BKEF 560M	230	50	2,2	14,2	50	1430	10000	52-44	F	55	145
BKEF 315T	380	50	0,25	0,87	-	1380	1800	37-29	F	55	51
BKEF 355T	380	50	0,25	0,87	-	1380	2800	41-33	F	55	63
BKEF 400T	380	50	0,37	1,2	-	1390	4000	42-34	F	55	78
BKEF 450T	380	50	0,55	1,6	-	1365	5200	45-37	F	55	87
BKEF 500T	380	50	1,1	2,6	-	1410	8000	49-42	F	55	120
BKEF 560T	380	50	2,2	4,9	-	1420	10000	52-44	F	55	145

Sound Level Measured from 3m distance in room condition.

Accessories

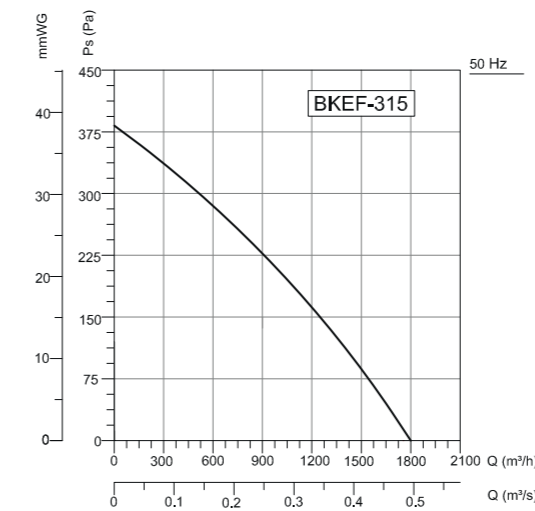
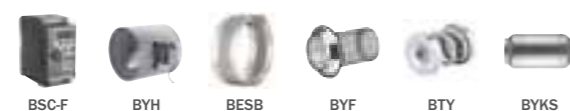

Frequency	Tot	63	125	250	500	1000	2000	4000	8000	Hz
L _{wa} Inlet	78	74	73	68	66	62	56	53	53	dB(A)
L _{wa} Outlet	80	76	75	70	67	64	58	55	55	dB(A)
L _{wa} Surrounding	60	56	55	50	48	44	38	35	35	dB(A)

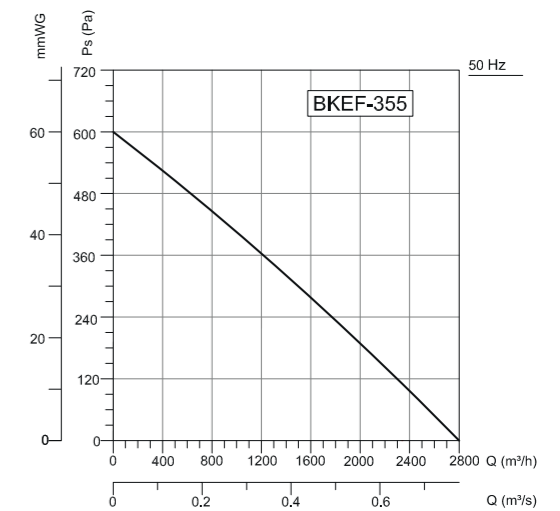

Frequency	Tot	63	125	250	500	1000	2000	4000	8000	Hz
L _{wa} Inlet	82	78	77	72	70	66	60	60	57	dB(A)
L _{wa} Outlet	84	80	79	74	72	68	62	62	59	dB(A)
L _{wa} Surrounding	64	60	59	54	52	48	42	42	39	dB(A)

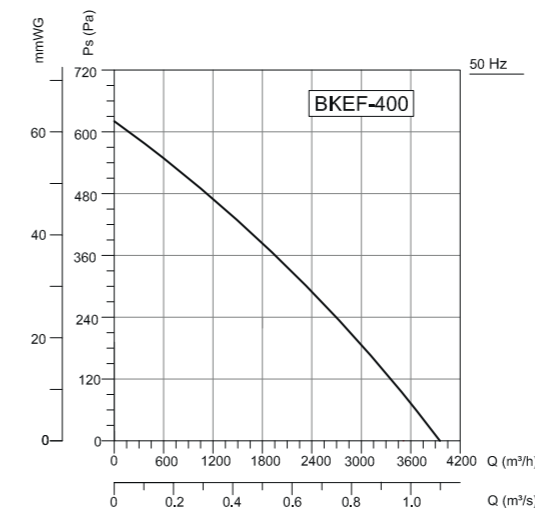

Frequency	Tot	63	125	250	500	1000	2000	4000	8000	Hz
L _{wa} Inlet	83	79	78	73	71	67	61	58	58	dB(A)
L _{wa} Outlet	85	81	80	75	73	69	63	60	60	dB(A)
L _{wa} Surrounding	65	61	60	55	53	49	43	40	40	dB(A)

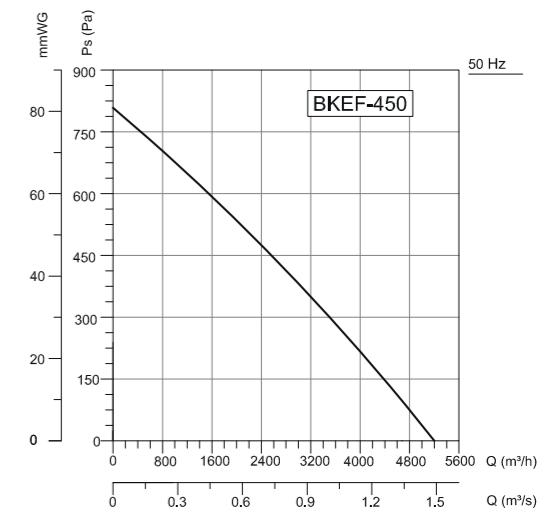

Frequency	Tot	63	125	250	500	1000	2000	4000	8000	Hz
L _{wa} Inlet	86	82	81	76	74	70	64	61	61	dB(A)
L _{wa} Outlet	88	84	83	78	76	75	66	63	63	dB(A)
L _{wa} Surrounding	68	64	63	58	56	52	46	43	43	dB(A)

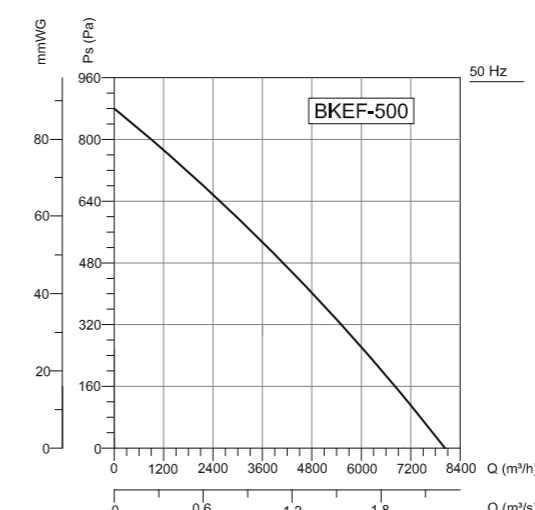

Frequency	Tot	63	125	250	500	1000	2000	4000	8000	Hz
L _{wa} Inlet	88	85	84	79	75	73	67	64	64	dB(A)
L _{wa} Outlet	91	87	86	81	79	78	69	66	66	dB(A)
L _{wa} Surrounding	71	67	66	61	59	55	49	46	46	dB(A)

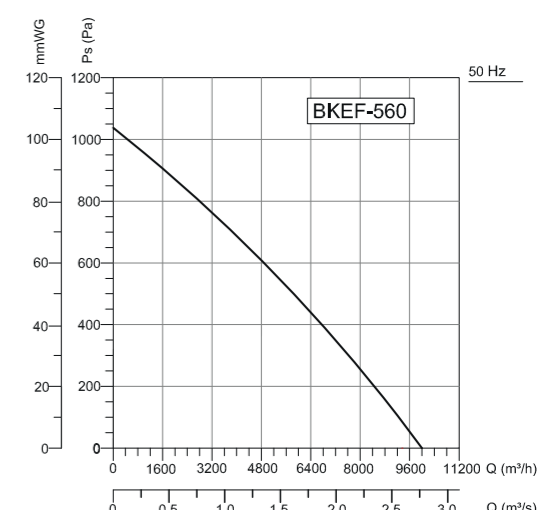

Frequency	Tot	63	125	250	500	1000	2000	4000	8000	Hz
L _{wa} Inlet	91	88	87	82	78	76	70	67	67	dB(A)
L _{wa} Outlet	94	90	89	84	82	81	72	69	69	dB(A)
L _{wa} Surrounding	74	70	69	64	62	58	52	49	49	dB(A)



BKEF-T

KITCHEN FANS / Forward Curved

Fan Components and Material Properties
The rectangular body and the impellers of the fans are made of high quality galvanized steel which is resistant to corrosion. Motor protection cover. The BSKF-R is equipped with an asynchronous motor outside the air flow. The device is capable of carrying air at max.120°C.

Fan Structure
Double-walled galvanized body and galvanized forward inclined fan impeller. The fan blades are forward-curved, combined with the plug-in technique and produced in an aerodynamic manner to ensure regular flow. It is designed to work between the rectangular channel. Opening direction interchangeable cover is available.

Benefits
Since the motor is out of airflow, it is resistant to high temperature. The swing-out lid allows the product to

be maintained effortlessly without removing the fan. The housing with fan connection and anti-vibration mountings are included in the isolated base frame. Thanks to the aerodynamic wing structure, they work quietly. Speed can be adjusted with speed control devices. 50 mm thick mineral wool was applied for sound and heat insulation. Water drainage feature.

Speed Control
Optional control devices can be provided. 3 ~ phase products can be controlled with frequency inverter speed control. (see BSC-F accessory)

Usage Areas
It is able to carry air at higher temperatures due to the motor being out of airflow. It should be used with a filter in kitchens that do not contain oil particles. The kitchen can also be used for ambient air ventilation. In order to achieve long service life, fan blade cleaning should be considered.

Technical Drawing and Tables

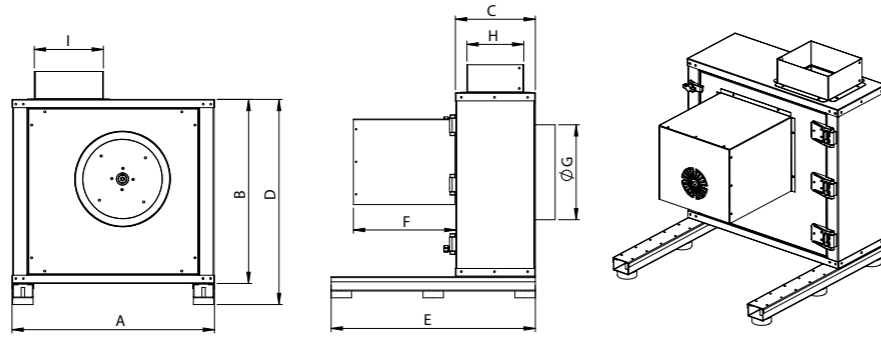

TYPE	A	B	C	D	E	F	G	H	I
BKEF-T 200	460	415	210	475	500	240	200	145	145
BKEF-T 225	495	460	210	520	500	240	210	145	165
BKEF-T 250	535	480	230	545	550	300	250	165	180
BKEF-T 280	595	540	235	605	600	300	280	170	205
BKEF-T 315	650	600	265	660	650	340	335	188	225
BKEF-T 355	730	660	310	820	650	405	340	210	256

Dimensions are in (mm)

TYPE	VOLTAGE	FREQUENCY	POWER	CURRENT	CAPACITOR	SPEED	AIR FLOW	SOUND PRESSURE	INSULATION CLASS	PROTECTION CLASS	WEIGHT
	V	Hz	kW	(A)	(µF)	r.p.m	m ³ /h	dB(A)	Ins.cl.	IP	kg
BKEF-T 200M	230	50	0,55	4,5	20	1365	1750	40	F	55	40
BKEF-T 225M	230	50	0,75	4,6	30	1405	2250	42	F	55	43
BKEF-T 250M	230	50	1,5	9,3	50	1410	3500	45	F	55	52
BKEF-T 280M	230	50	1,5	9,3	50	1410	4200	48	F	55	63
BKEF-T 315M	230	50	3	19	60	1425	5000	50	F	55	78
BKEF-T 200T	380	50	0,55	1,6	-	1365	1750	40	F	55	40
BKEF-T 225T	380	50	0,75	2,1	-	1405	2250	42	F	55	43
BKEF-T 250T	380	50	1,5	3,5	-	1410	3500	45	F	55	52
BKEF-T 280T	380	50	1,5	3,5	-	1410	4200	48	F	55	63
BKEF-T 315T	380	50	3	6,9	-	960	5000	50	F	55	78
BKEF-T 355T	380	50	3	6,9	-	960	6000	45	F	55	85

Sound Level Measured from 3m distance in room condition.

Accessories

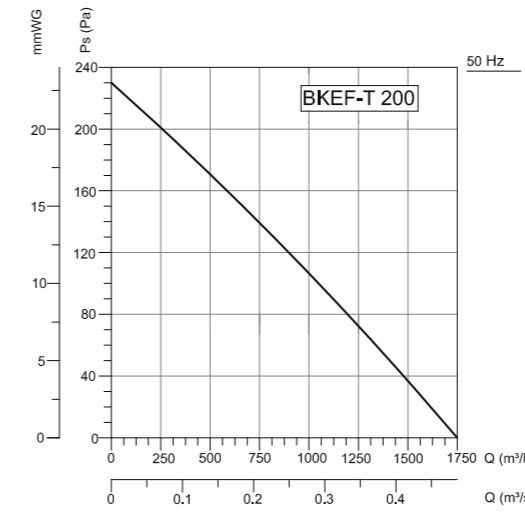
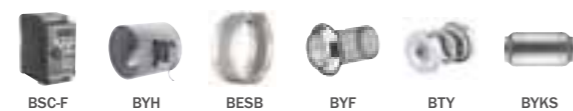

Frequency	Tot	63	125	250	500	1000	2000	4000	8000	Hz
L _{wa} Inlet	81	79	75	72	68	66	62	58	58	dB(A)
L _{wa} Outlet	83	81	77	74	70	68	64	60	60	dB(A)
L _{wa} Surrounding	63	61	57	54	50	48	44	40	40	dB(A)

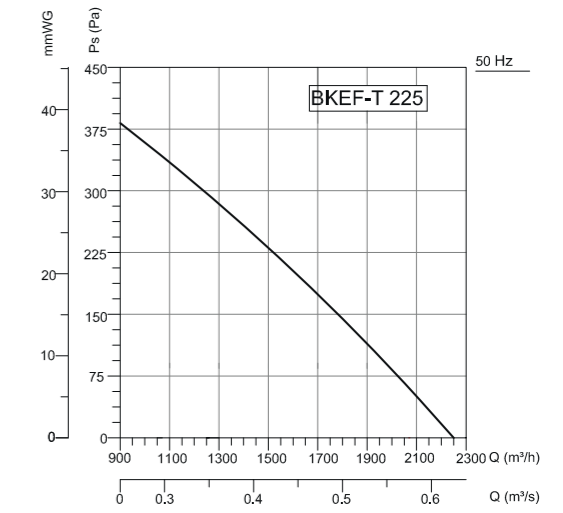

Frequency	Tot	63	125	250	500	1000	2000	4000	8000	Hz
L _{wa} Inlet	83	81	77	74	70	68	64	60	60	dB(A)
L _{wa} Outlet	85	83	79	76	72	70	66	62	62	dB(A)
L _{wa} Surrounding	65	63	59	56	52	50	46	42	42	dB(A)

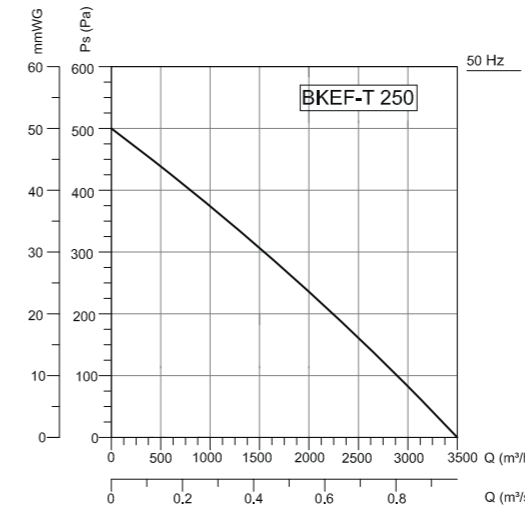

Frequency	Tot	63	125	250	500	1000	2000	4000	8000	Hz
L _{wa} Inlet	89	84	86	75	73	72	68	64	64	dB(A)
L _{wa} Outlet	88	86	81	80	75	74	69	64	64	dB(A)
L _{wa} Surrounding	68	65	61	60	56	54	49	45	45	dB(A)

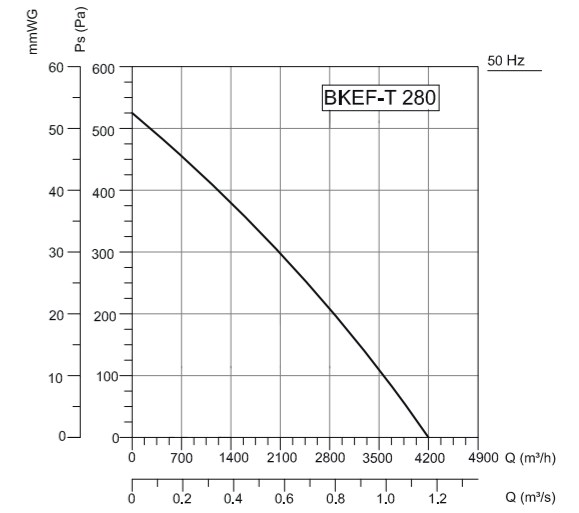

Frequency	Tot	63	125	250	500	1000	2000	4000	8000	Hz
L _{wa} Inlet	89	87	83	80	76	74	70	66	66	dB(A)
L _{wa} Outlet	91	89	85	82	78	76	72	68	68	dB(A)
L _{wa} Surrounding	71	69	65	62	58	56	52	46	46	dB(A)

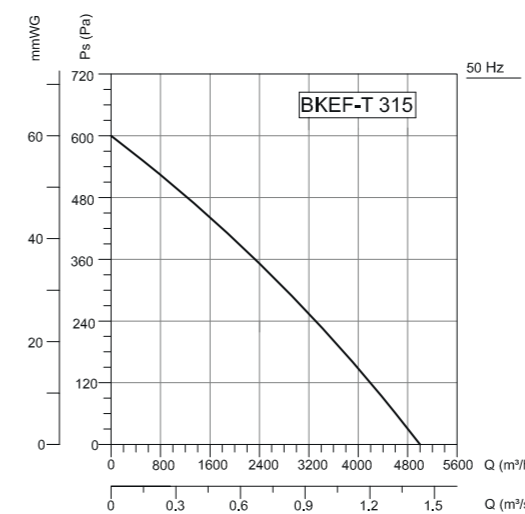

Frequency	Tot	63	125	250	500	1000	2000	4000	8000	Hz
L _{wa} Inlet	91	89	85	82	78	76	72	68	68	dB(A)
L _{wa} Outlet	93	91	87	84	80	78	74	70	70	dB(A)
L _{wa} Surrounding	73	71	67	64	60	58	54	48	48	dB(A)

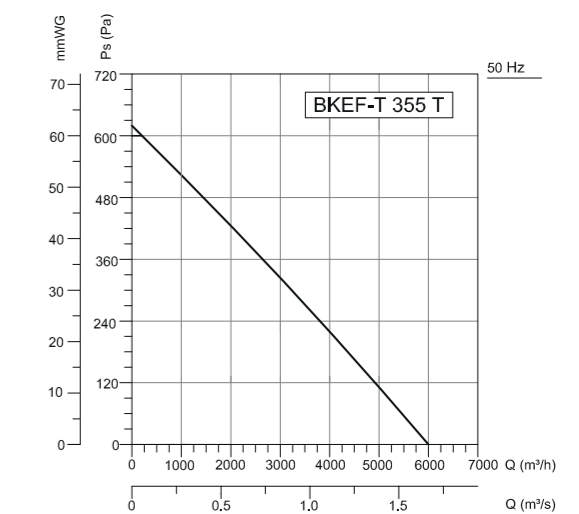

Frequency	Tot	63	125	250	500	1000	2000	4000	8000	Hz
L _{wa} Inlet	88	84	85	76	72	73	68	64	64	dB(A)
L _{wa} Outlet	87	85	80	79	74	73	68	63	63	dB(A)
L _{wa} Surrounding	68	65	61	60	56	54	49	45	45	dB(A)

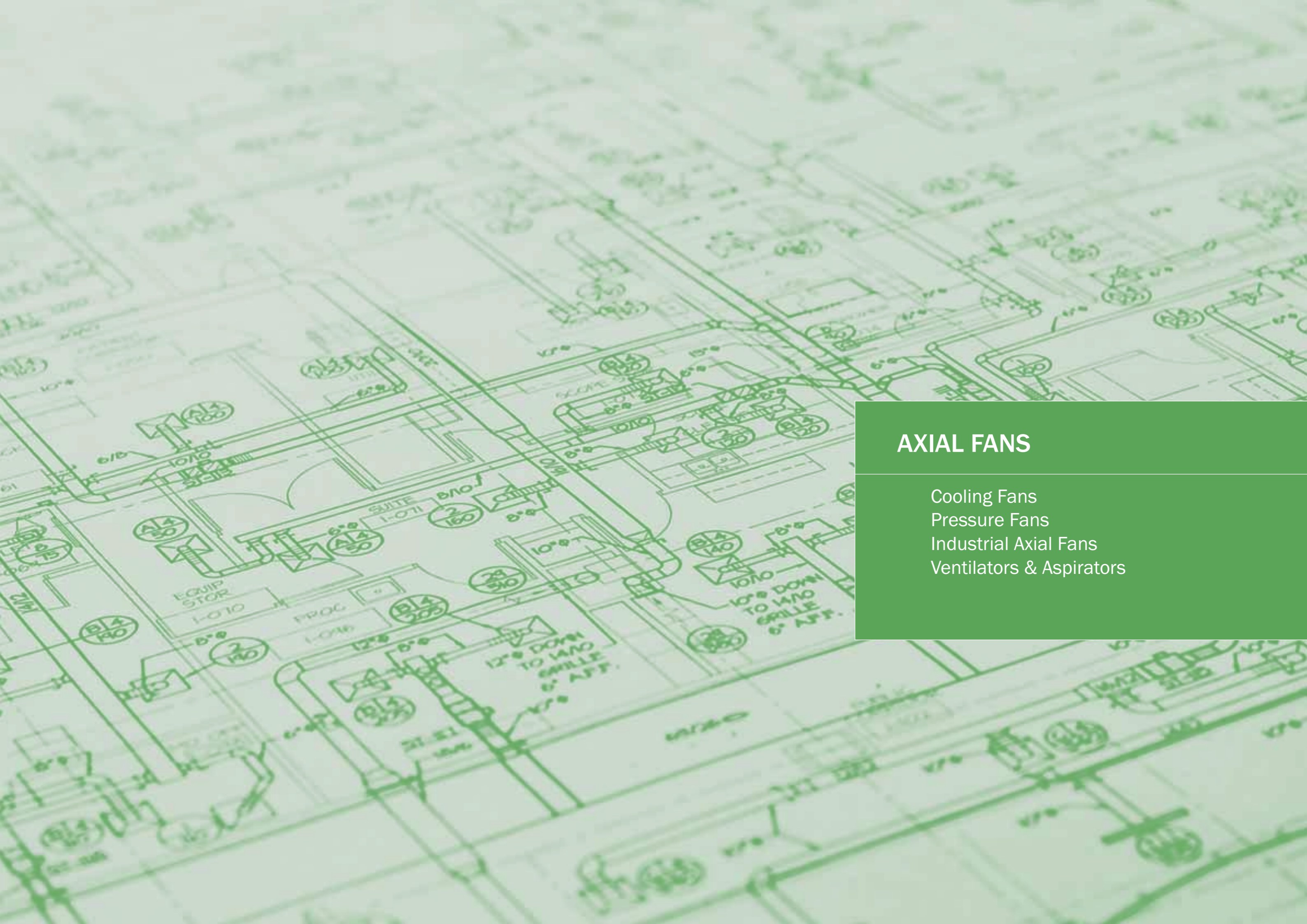

AXIAL FANS

Cooling Fans
Pressure Fans
Industrial Axial Fans
Ventilators & Aspirators

AXIAL FANS

They work with low energy consumption in a high air flow rates. They are used in different applications such as cooling, heating, building, car park ventilation and industrial ventilation with comprehensive model options.

USAGE AREA

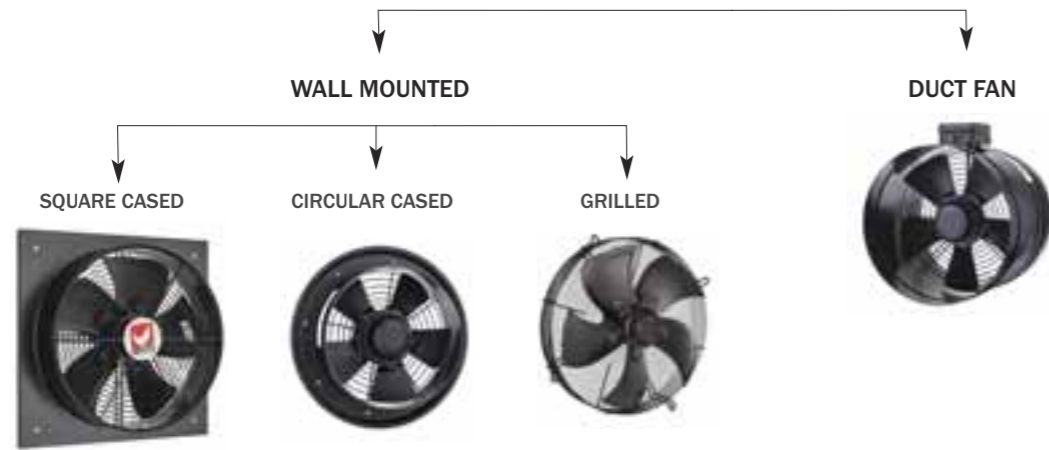

IMPELLER TYPE





SF COOLING FANS

Fan Components and Material Properties

The propeller is manufactured from electrostatic powder coated sheet metal, protective wire and wire mesh electrostatic powder coated steel wire. The propeller is coupled directly to the motor. Protective and carrier wireframe produced in standard connection dimensions.

* Square Plate and Flat Grill options are available. Please contact BVN representatives.

Benefits

With its blower and suction types, the SF cooling fans are designed for high performance, low noise level and long-term maintenance-free operation in a variety of applications. Speed can be adjusted

with speed control devices. Propellers are manufactured in the most ideal angle according to their size and maximum performance is ensured.

Speed Control

Optional control devices can be provided. 1-Phase products can be controlled with linear voltage regulator (see BSC accessory). * In line with the demand, three-phase models can be produced in accordance with the inverter.

Usage Areas

Refrigeration machines, laboratories, residences, air-conditioning outdoor units, hot and cold air appliances and industrial chillers etc. used in places.

Technical Drawing and Tables

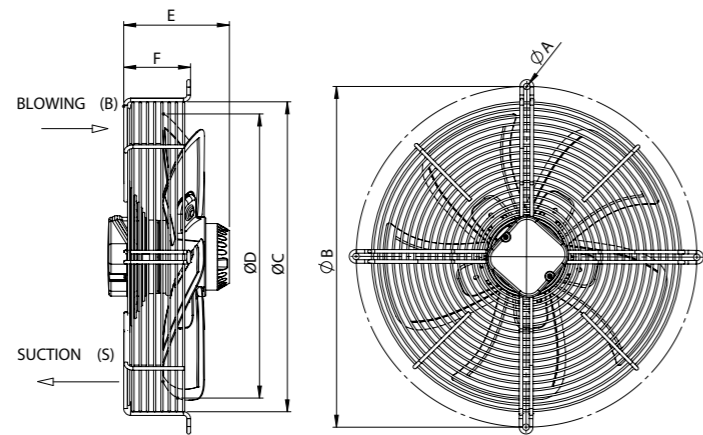

TYPE	A	B	C	D	E	F
SF 250	6,5	321	280	250	115	75
SF 300	6,5	360	329	300	115	61
SF 350	6,5	422	374	345	148	88
SF 400	9	470	422	396	146	93
SF 450	9	522	472	444	160	93

Dimensions are in (mm)

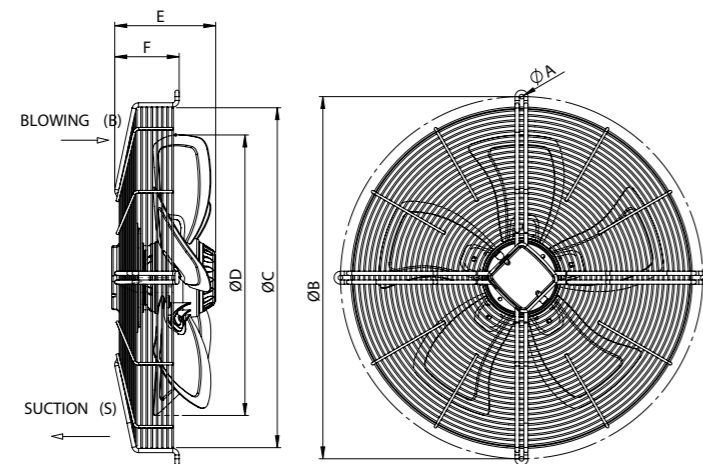

TYPE	A	B	C	D	E	F
SF 500	9	565	520	500	170	97
SF 560	9	700	654	552	198	124
SF 630	9	750	700	623	198	142

Dimensions are in (mm)

TYPE	VOLTAGE	FREQUENCY	POWER	CURRENT	CAPACITOR	SPEED	AIR FLOW	SOUND PRESSURE	INSULATION CLASS	PROTECTION CLASS	WEIGHT
	V	Hz	W	(A)	(µF)	r.p.m	m³/h	dB(A)	Ins.cl.	IP	kg
SF-4M 250 B	230	50/60	50/60	0,22/0,26	2	1400/1670	1000/1190	44	F	54	2,5
SF-4M 300 B	230	50/60	72/87	0,32/0,38	2,5	1300/1450	1700/1900	50	F	54	4
SFX-4M 300 B	230	50/60	100/120	0,5/0,54	3,5	1450/1710	1900/2240	50	F	54	4
SF-4M 350 B	230	50/60	165/195	0,75/0,85	4	1380/1545	3300/3700	55	F	54	4,7
SF-4M 400 B	230	50/60	160/220	0,75/1,1	5	1400/1650	4000/4700	58	F	54	6,1
SF-4M 450 B	230	50/60	245/355	1,2/1,6	7	1400/1600	5700/6500	63	F	54	6,9
SFX-6M 450 B	230	50/60	165/220	0,75/0,95	4	910/1025	4575/5225	55	F	54	6,9
SF-4M 500 B	230	50/60	450/600	1,98/2,65	10	1300/1450	6900/7700	65	F	55	9,5
SFX-4M 500 B	230	50	750	3,28	16	1260	9250	66	F	55	10,5
SFX-6M 500 B	230	50/60	220/275	0,99/1,2	6,3	850	6240	58	F	55	10,5
SFX-4M 560 B	230	50	1000	4,8	12,5	1250	11000	81	F	55	15
SFX-6M 560 B	230	50	450	2	10	875	8000	62	F	55	15
SFX-6M 630 B	230	50/60	630/750	2,9	12,5	850	11000	65	F	55	18

SFX-4T 300 B	Y380/Δ220	50/60	90/108	0,29/0,52	-	1450/1710	1900/2240	50	F	54	4
SF-4T 350 B	Y380/Δ220	50/60	160/170	0,33/0,58	-	1380/1545	3300/3700	55	F	54	4,7
SF-4T 400 B	Y380/Δ220	50/60	140/190	0,47/0,8	-	1400/1650	4000/4700	58	F	54	6,1
SF-4T 450 B	Y380/Δ220	50/60	200/285	0,5/0,55	-	1400/1600	5700/6500	63	F	54	6,9
SF-4T 500 B	380 Δ / Y	50	425/250	0,87/0,45	-	1300/1000	6900/5300	65	F	55	9,5
SFX-4T 500 B	380 Δ / Y	50	800/550	1,6/0,95	-	1260/1000	9250/7340	66	F	55	10,5
SFX-8T 500 B	380 Δ / Y	50/60	150/85	0,40/0,15	-	650/550	4770/4040	52	F	55	10,5
SFX-4T 560 B	380 Δ / Y	50	1200/800	2,6/1,5	-	1325/1050	12000/9500	68	F	55	15
SFX-6T 560 B	380 Δ / Y	50	500/300	1/0,5	-	875/650	8000/5950	62	F	55	15
SFX-6T 630 B	380 Δ / Y	50/60	600/400	1,25/0,70	-	850/650	11000/8400	65	F	54	18

SF-4M 250 S	230	50/60	50/60	0,22/0,26	2	1400/1670	1000/1190	44	F	54	2,5
SF-4M 300 S	230	50/60	72/87	0,32/0,38	2,5	1300/1450	1700/1900	50	F	54	4
SFX-4M 300 S	230	50/60	100/120	0,5/0,54	3,5	1450/1710	1900/2240	50	F	54	4
SF-4M 350 S	230	50/60	165/195	0,75/0,85	4	1380/1545	3300/3700	55	F	54	4,7
SF-4M 400 S	230	50/60	160/220	0,75/1,1	5	1400/1650	4000/4700	58	F	54	6,1
SF-4M 450 S	230	50/60	245/355	1,2/1,6	7	1400/1600	5700/6500	63	F	54	6,9
SFX-6M 450 S	230	50/60	165/220	0,75/0,95	4	910/1025	4575/5225	55	F	54	6,9
SF-4M 500 S	230	50/60	450/600	1,98/2,65	10	1300/1450	6900/7700	65	F	55	9,5
SFX-4M 500 S	230	50	750	3,28	16	1260	9250	66	F	55	10,5
SFX-6M 500 S	230	50/60	220/275	0,99/1,2	6,3	850	6240	58	F	55	10,5
SFX-4M 560 S	230	50	1000	4,8	12,5	1250	11000	81	F	55	15
SFX-6M 560 S	230	50	450	2	10	875	8000	62	F	55	15
SFX-6M 630 S	230	50/60	630/750	2,9	12,5	850	11000	65	F	55	18

SFX-4T 300 S	Y380/Δ220	50/60	90/108	0,29/0,52	-	1450/1710	1900/2240	50	F	54	4
SF-4T 350 S	Y380/Δ220	50/60	160/170	0,33/0,58	-	1380/1545	3300/3700	55	F	54	4,7
SF-4T 400 S	Y380/Δ220	50/60	140/190	0,47/0,8	-	1400/1650	4000/4700	58	F	54	6,1
SF-4T 450 S	Y380/Δ220	50/60	200/285	0,5/0,55	-	1400/1600	5700/6500	63	F	54	6,9
SF-4T 500 S	380 Δ / Y	50	425/250	0,87/0,45	-	1300/1000	6900/5300	65	F	55	9,5
SFX-4T 500 S	380 Δ / Y	50	800/550	1,6/0,95	-	1260/1000	9250/7340	66	F	55	10,5
SFX-8T 500 S	380 Δ / Y	50/60	150/85	0,40/0,15	-	650/550	4770/4040	52	F	55	10,5
SFX-4T 560 S	380 Δ / Y	50	1200/800	2,6/1,5	-	1325/1050	12000/9500	68	F	55	15
SFX-6T 560 S	380 Δ / Y	50	500/300	1/0,5	-	875/650	8000/5950	62	F	55	15
SFX-6T 630 S	380 Δ / Y	50/60	600/400	1,25/0,70	-	850/650	11000/8400	65	F	54	18

Sound Level Measured from 3m distance in room condition.

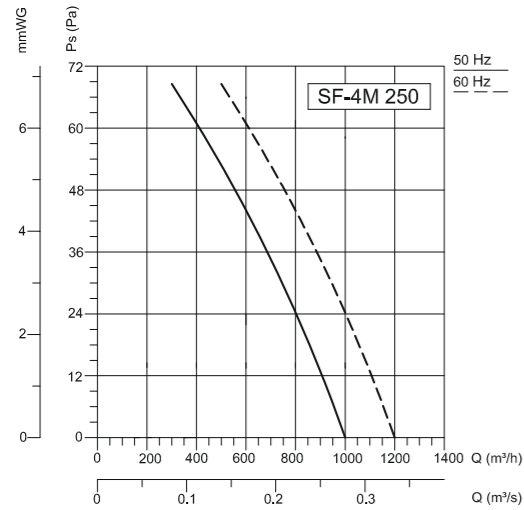

Frequency	Tot	63	125	250	500	1000	2000	4000	8000	Hz
L_{WA} Inlet	51	22	40	46	44	45	42	23		dB(A)

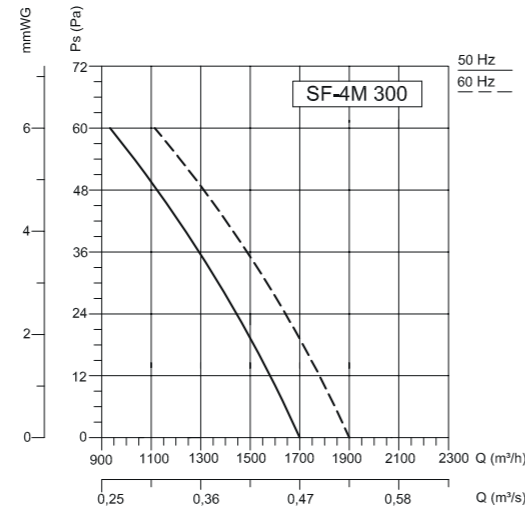

Frequency	Tot	63	125	250	500	1000	2000	4000	8000	Hz
L_{WA} Inlet	51	22	40	46	44	45	42	23		dB(A)

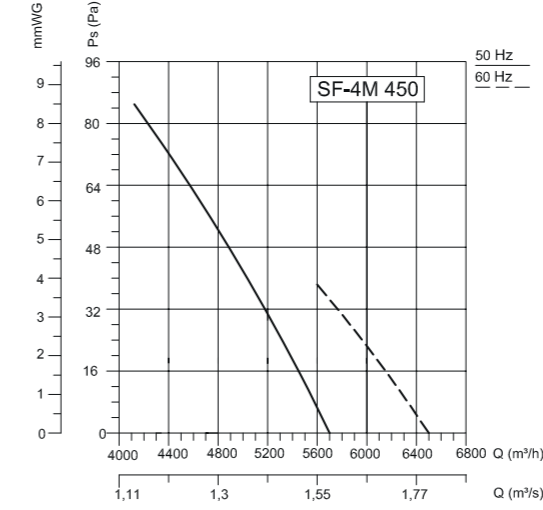

Frequency	Tot	63	125	250	500	1000	2000	4000	8000	Hz
L_{WA} Inlet	70	51	60	62	65	65	53	51		dB(A)

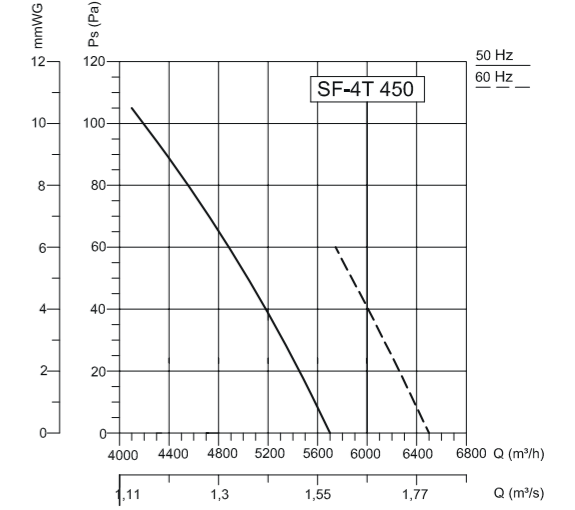

Frequency	Tot	63	125	250	500	1000	2000	4000	8000	Hz
L_{WA} Inlet	70	51	60	62	65	65	53	51		dB(A)

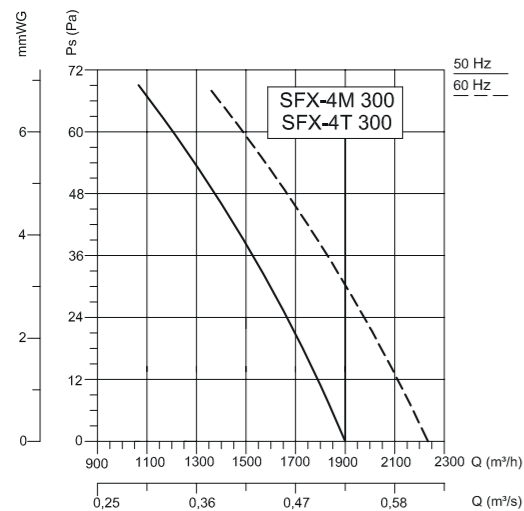

Frequency	Tot	63	125	250	500	1000	2000	4000	8000	Hz
L_{WA} Inlet	58	30	48	53	51	52	49	32		dB(A)

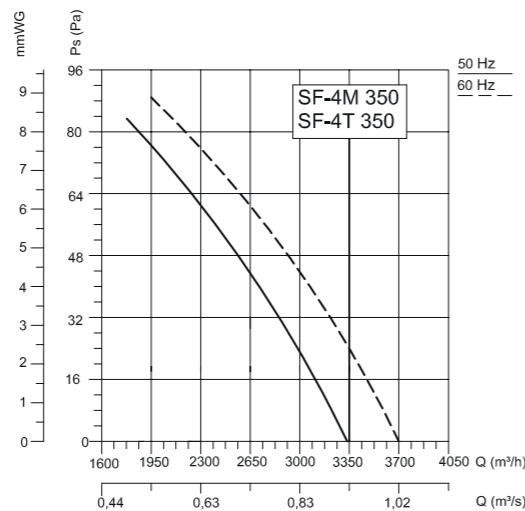

Frequency	Tot	63	125	250	500	1000	2000	4000	8000	Hz
L_{WA} Inlet	62	43	52	53	55	57	55	54		dB(A)

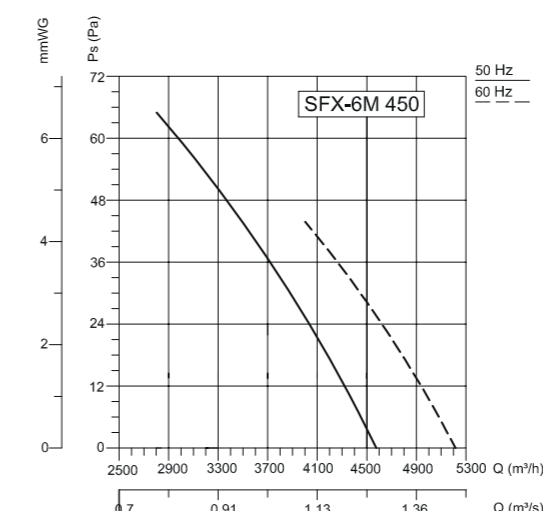

Frequency	Tot	63	125	250	500	1000	2000	4000	8000	Hz
L_{WA} Inlet	62	43	52	53	55	57	55	54		dB(A)

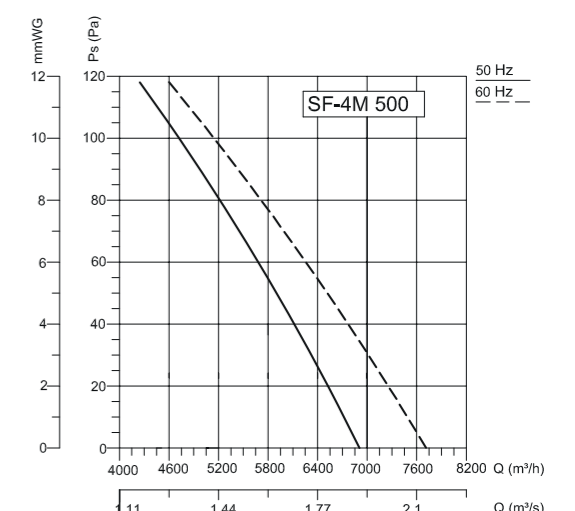

Frequency	Tot	63	125	250	500	1000	2000	4000	8000	Hz
L_{WA} Inlet	72	53	61	63	66	67	65	53		dB(A)

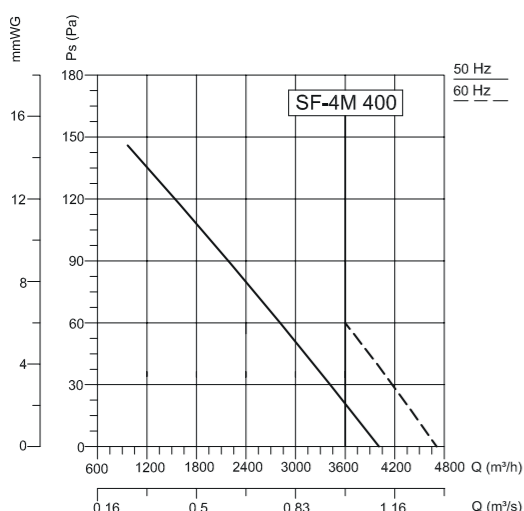

Frequency	Tot	63	125	250	500	1000	2000	4000	8000	Hz
L_{WA} Inlet	65	56	53	59	57	59	59	47		dB(A)

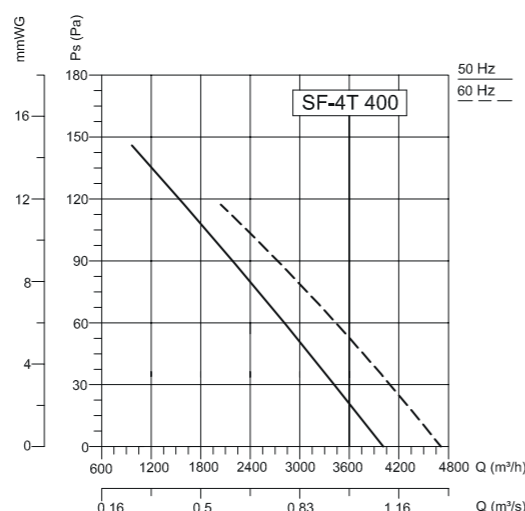

Frequency	Tot	63	125	250	500	1000	2000	4000	8000	Hz
L_{WA} Inlet	65	56	53	59	57	59	59	47		dB(A)

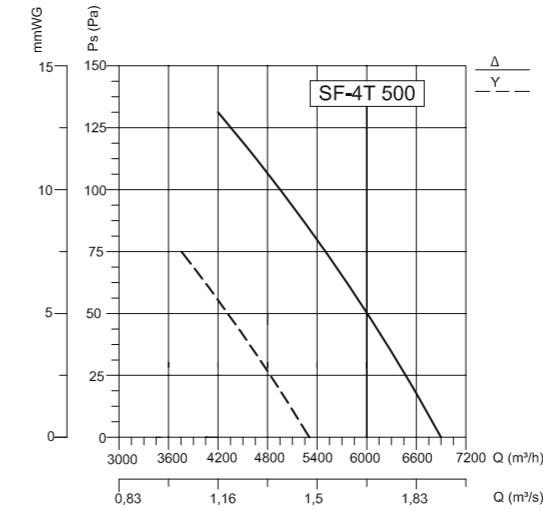

Frequency	Tot	63	125	250	500	1000	2000	4000	8000	Hz
L_{WA} Inlet	72	53	61	63	66	67	65	53		dB(A)

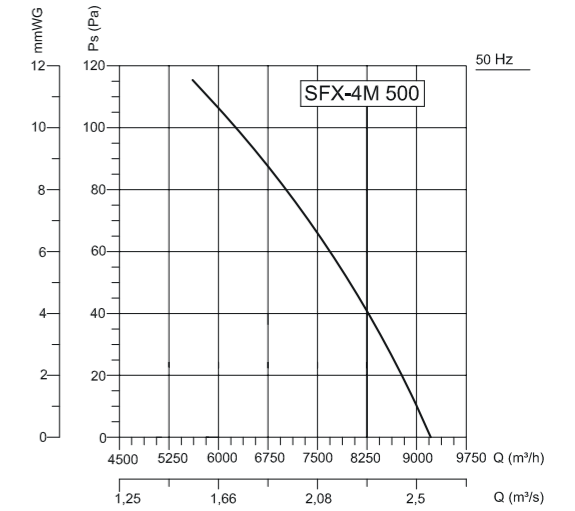

Frequency	Tot	63	125	250	500	1000	2000	4000	8000	Hz
L_{WA} Inlet	73	54	62	64	67	68	66	54		dB(A)

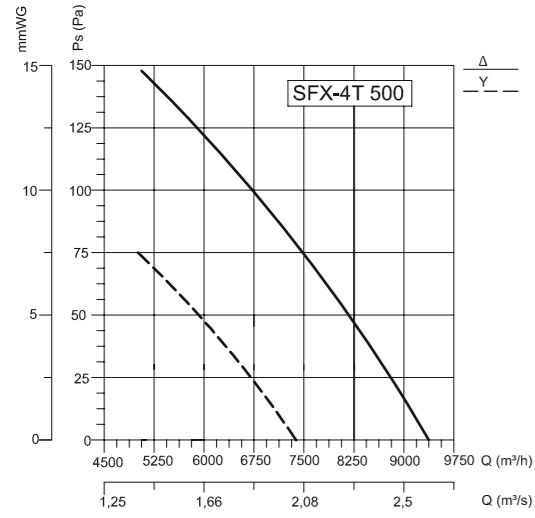

Frequency	Tot	63	125	250	500	1000	2000	4000	8000	Hz
L_{wA} Inlet	73	54	62	64	67	68	66	54		dB(A)

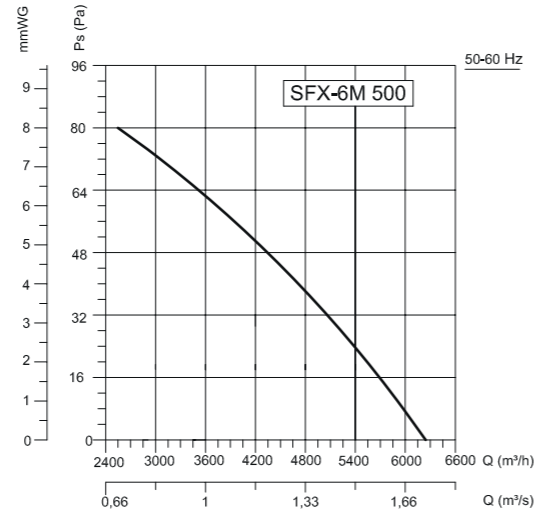

Frequency	Tot	63	125	250	500	1000	2000	4000	8000	Hz
L_{wA} Inlet	65	56	53	59	57	59	59	47		dB(A)

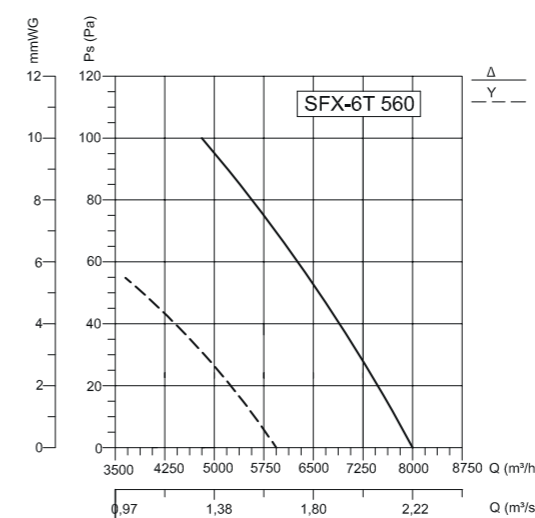

Frequency	Tot	63	125	250	500	1000	2000	4000	8000	Hz
L_{wA} Inlet	69	53	59	62	64	63	59	50		dB(A)

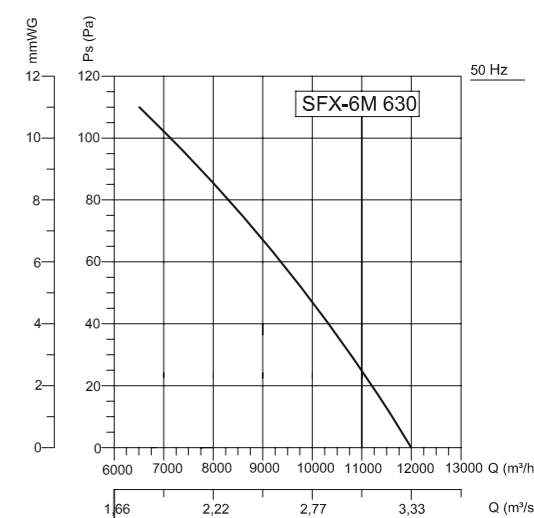

Frequency	Tot	63	125	250	500	1000	2000	4000	8000	Hz
L_{wA} Inlet	72	57	63	65	66	66	63	53		dB(A)

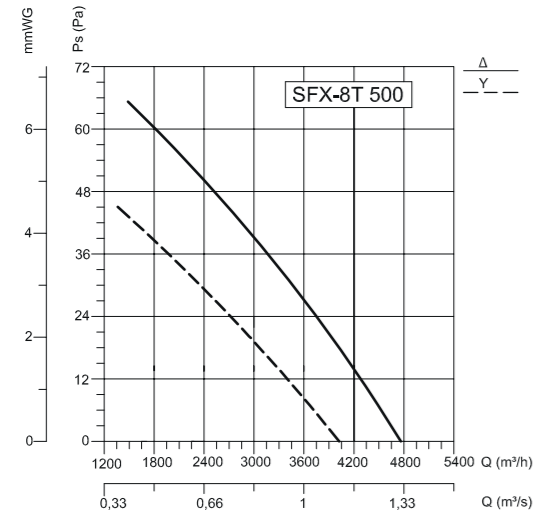

Frequency	Tot	63	125	250	500	1000	2000	4000	8000	Hz
L_{wA} Inlet	59	30	48	54	52	53	50	31		dB(A)

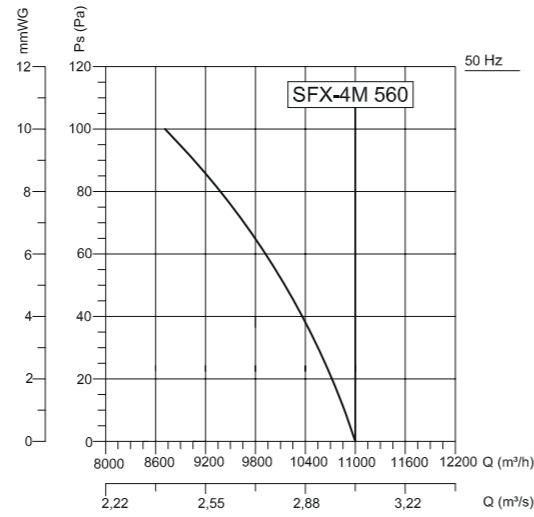

Frequency	Tot	63	125	250	500	1000	2000	4000	8000	Hz
L_{wA} Inlet	75	59	65	68	70	69	65	56		dB(A)

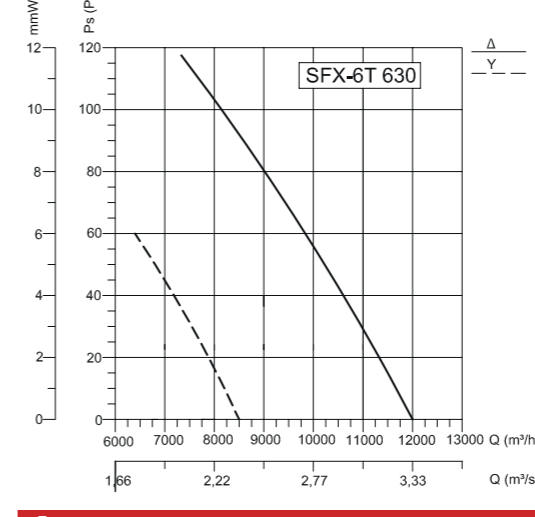

Frequency	Tot	63	125	250	500	1000	2000	4000	8000	Hz
L_{wA} Inlet	72	57	63	65	66	66	63	53		dB(A)

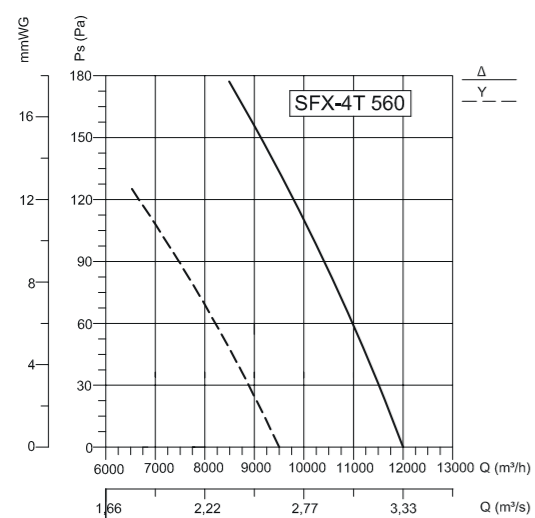

Frequency	Tot	63	125	250	500	1000	2000	4000	8000	Hz
L_{wA} Inlet	75	59	65	68	70	69	65	56		dB(A)

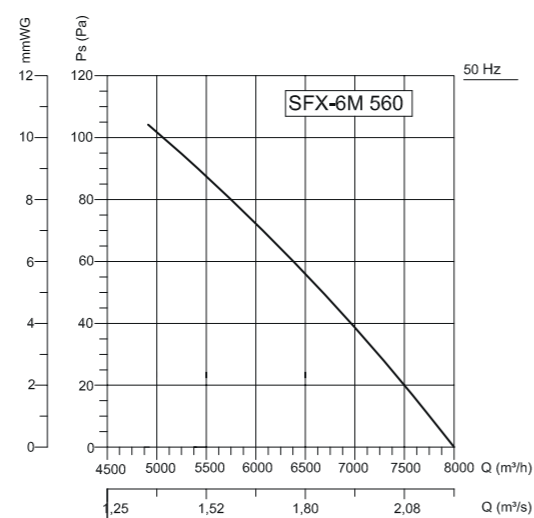

Frequency	Tot	63	125	250	500	1000	2000	4000	8000	Hz
L_{wA} Inlet	69	53	59	62	64	63	59	50		dB(A)





BDRAX

COOLING FANS

Fan Components and Material Properties

The case and propeller are made of electrostatic powder coated sheet metal and electrostatic powder coated from protective wire mesh strip steel. The motor and fan impeller are connected to the main body by steel carriers. It has an external rotor motor with closed structure.

Benefits

Thanks to their ideal wing angles, they achieve high air flow at minimum sound levels despite their small size. Easily mounted on windows and wall.

Speed Control

Optional control devices can be provided. * Speed control can be done with linear voltage regulator. (see BSC accessory)

Usage Areas

It is used for exhausting indoor air or for the need for fresh air. It is also used for air circulation by machine manufacturers.

Accessories



Technical Drawing and Tables

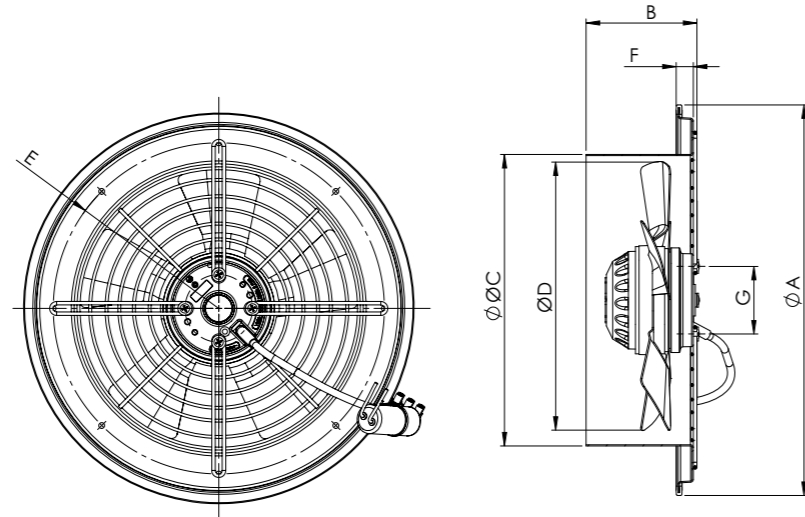

TYPE	A	B	C	D	E	F	G
BDRAX 200-2K	284	95	200	189	229	14	58
BDRAX 200-4K	284	95	200	189	229	14	58
BDRAX 250-2K	335	95	250	238	284	14	58
BDRAX 250-4K	335	95	250	238	284	14	58
BDRAX 300-2K	390	95	300	288	332	14	58
BDRAX 300-4K	390	95	300	288	332	14	58
BDRAX 350-2K	427	100	350	338	398	2	58
BDRAX 350-4K	427	100	350	338	398	2	58

Dimensions are in (mm)

TYPE	VOLTAGE	FREQUENCY	POWER	CURRENT	CAPACITOR	SPEED	AIR FLOW	SOUND PRESSURE	INSULATION CLASS	PROTECTION CLASS	WEIGHT
TYPE	V	Hz	W	(A)	(µF)	r.p.m	m ³ /h	dB(A)	Ins.cl.	IP	kg
BDRAX 200-2K	230	50/60	63	0,28	2	2750/3200	680/790	50	B	44	2
BDRAX 200-4K	230	50/60	55	0,26	2	1450/1750	407/490	40	B	44	2,2
BDRAX 250-2K	230	50/60	100	0,5	4	2700/3100	1500/1700	55	B	44	2,7
BDRAX 250-4K	230	50/60	55	0,28	1,5	1400/1680	760/910	41	B	44	2,7
BDRAX 300-2K	230	50/60	140/190	0,6/0,85	5	2600/2800	2020/2175	57	B	44	3,5
BDRAX 300-4K	230	50/60	65	0,29	2	1360/1550	1410/1600	47	B	44	3,5
BDRAX 350-2K	230	50/60	200	0,9	5	2050	3110	62	B	44	4,6
BDRAX 350-4K	230	50/60	75/100	0,32/0,45	3	1330/1500	2340/2640	52	B	44	4,6

The sound level is measured at a distance of 3 m in open field condition.

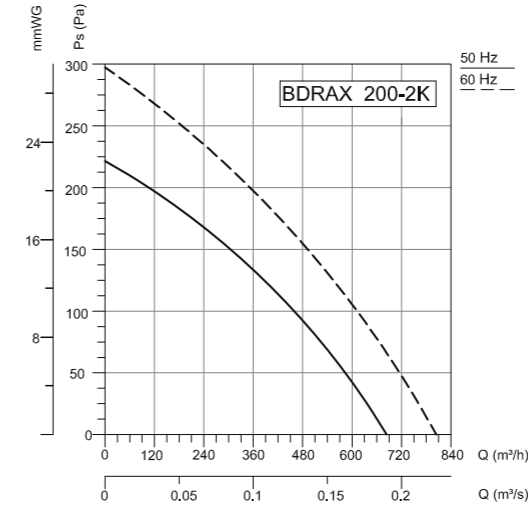

Frequency	Tot	63	125	250	500	1000	2000	4000	8000 Hz
SURROUNDING	71	38	43	64	64	65	64	58	50 dB(A)

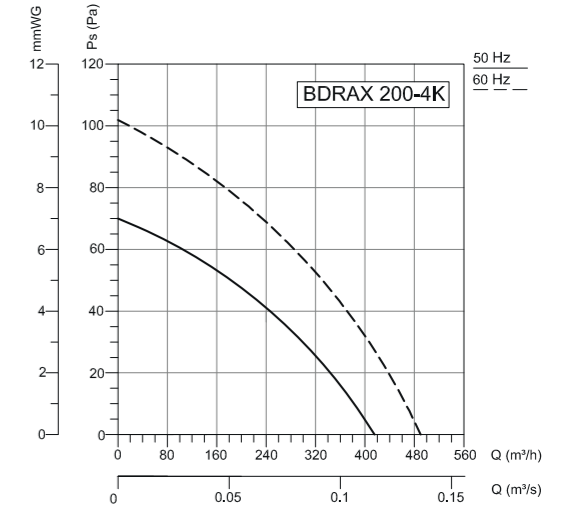

Frequency	Tot	63	125	250	500	1000	2000	4000	8000 Hz
L _{wa} Surrounding	61	27	32	54	54	55	54	48	39 dB(A)

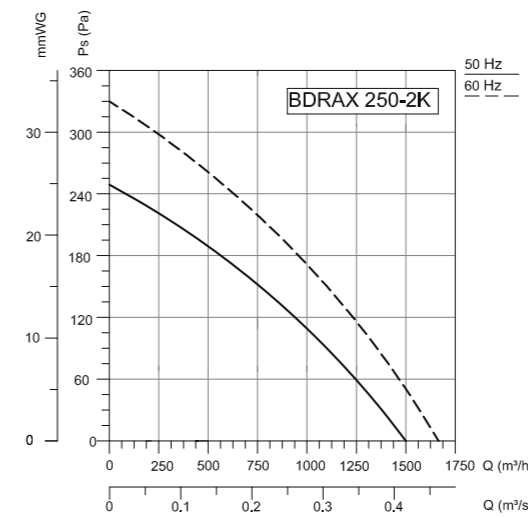

Frequency	Tot	63	125	250	500	1000	2000	4000	8000 Hz
L _{wa} Surrounding	76	44	51	66	66	70	71	67	62 dB(A)

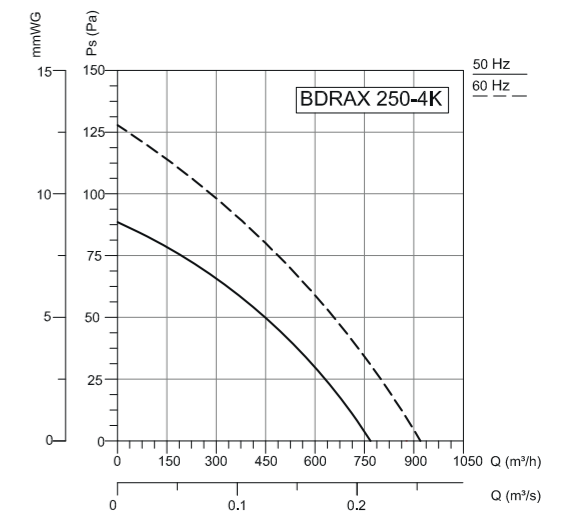

Frequency	Tot	63	125	250	500	1000	2000	4000	8000 Hz
L _{wa} Surrounding	62	30	37	52	51	56	57	53	48 dB(A)

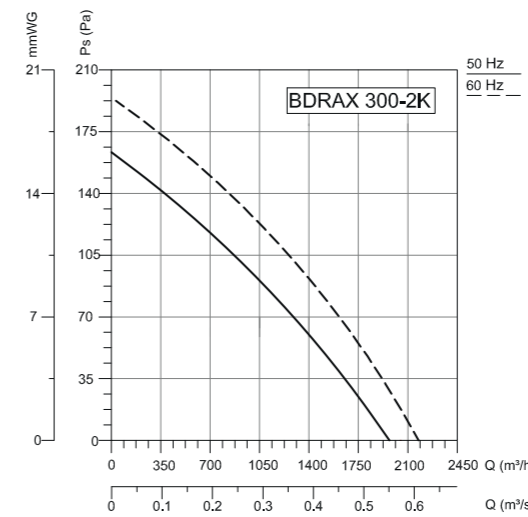

Frequency	Tot	63	125	250	500	1000	2000	4000	8000 Hz
L _{wa} Surrounding	78	46	53	68	68	72	73	69	64 dB(A)

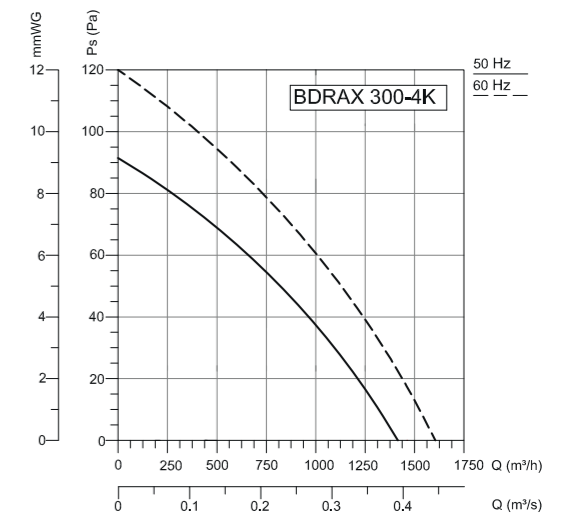

Frequency	Tot	63	125	250	500	1000	2000	4000	8000 Hz
L _{wa} Surrounding	68	39	51	54	63	63	63	58	48 dB(A)

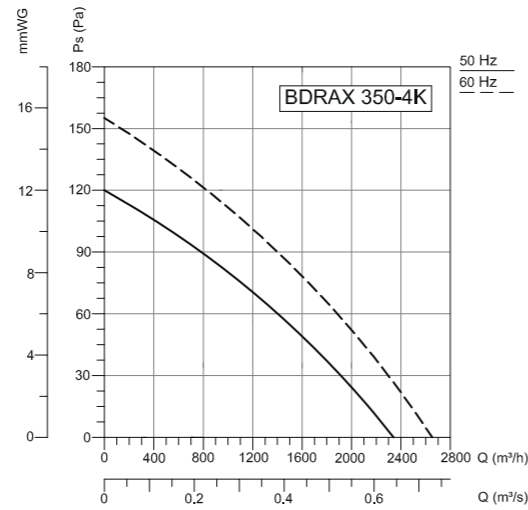
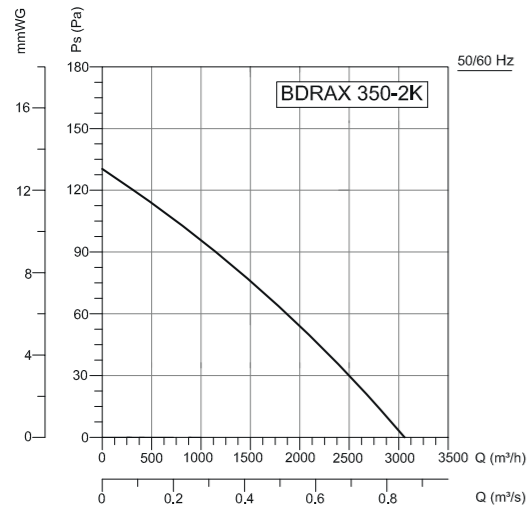

Frequency	Tot	63	125	250	500	1000	2000	4000	8000	Hz
L_{wa} Surrounding	83	48	64	68	74	80	78	73	60	dB(A)

Frequency	Tot	63	125	250	500	1000	2000	4000	8000	Hz
L_{wa} Surrounding	73	38	54	58	64	70	68	63	50	dB(A)



BTFM

PRESSURATION FANS / Tube

Fan Components and Material Properties

Cylindrical tube casing, airfoil wing structure and direct coupled motor fans with 3500 m³ / h flow rate of 115000 m³ / h and Ø400 mm -Ø1250 mm 16 models are available in the range options. Body is made of steel with electrostatic powder coating. The motor and fan impeller are connected to the main body by steel carriers. It can be manufactured with foot on request.

Fan Structure

Axial wings are produced in pressurized aluminum casting and airfoil structure. The aerodynamically optimized wings provide high efficiency.

Benefits

It works with low noise levels and is designed to be maintenance-free for long periods of time. Speed can be adjusted with speed control devices. The wings are manufactured at the ideal angle and in the form of wings and provide maximum performance.

Speed Control

Optional control devices can be provided. 3-phase products can be controlled by frequency inverter (see BSC-F accessory).

Usage Areas

BTFM type axial fans are used for stair pressurization, lift pressurization, ambient pressurization and ambient exhaust applications. They are manufactured from durable metal alloy body by using high efficiency aluminum fins.

Technical Drawing and Tables

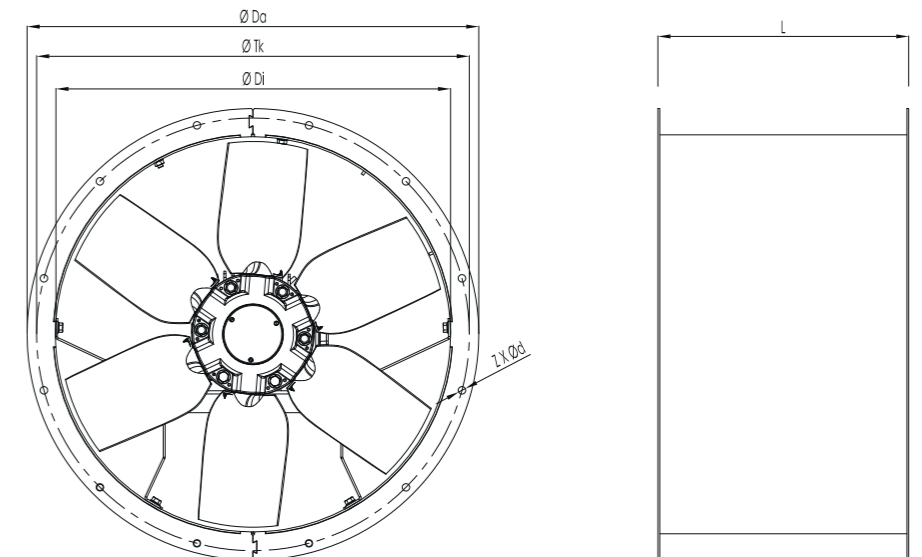

TYPE	ØDi	ØDa	ØTk	ØL	ZXØD
BTFM 400	400	480	450	350	8X12
BTFM 450	450	530	500	350	8X12
BTFM 500	500	590	560	400	12X12
BTFM 560	560	650	620	400	12X12
BTFM 630	630	720	690	400	12X12
BTFM 710	710	800	770	450	16X12
BTFM 800	800	890	860	500	16X12
BTFM 900	900	1005	970	550	16X15
BTFM 1000	1000	1105	1070	700	16X15
BTFM 1250	1250	1390	1320	850	20X15

Dimensions are in (mm)

TYPE	VOLTAGE	FREQUENCY	POWER	CURRENT	CAPACITOR	SPEED	AIR FLOW	SOUND PRESSURE	INSULATION CLASS	PROTECTION CLASS
	V	Hz	kW	(A)	(μ F)	r.p.m	m ³ /h	dB(A)	Ins.cl.	IP
BTFM 400-M/6-20/0,37/4A	230	50	0,37	2,6	15	1390	3500	60	F	55
BTFM 450-M/6-20/0,55/4A	230	50	0,55	3,3	20	1365	4500	62	F	55
BTFM 500-M/6-20/0,55/4A	230	50	0,55	3,3	20	1365	7000	66	F	55
BTFM 560-M/6-18/0,75/4A	230	50	0,75	4,6	30	1405	10000	63	F	55
BTFM 630-M/6-16/1,1/4A	230	50	1,1	7,1	35	1410	14000	70	F	55
BTFM 710-M/6-14/1,5/4A	230	50	1,5	3,5	50	1410	17500	71	F	55
BTFM 800-M/6-10/2,2/4A	230	50	2,2	13,4	60	1425	23000	74	F	55
BTFM 800-M/6-14/3/4A	230	50	3	19,0	60	1425	25000	76	F	55
BTFM 400-T/6-20/0,37/4A	380	50	0,37	1,2	-	1390	3500	60	F	55
BTFM 450-T/6-20/0,55/4A	380	50	0,55	1,6	-	1365	4500	62	F	55
BTFM 500-T/6-20/0,55/4A	380	50	0,55	1,6	-	1365	7000	66	F	55
BTFM 560-T/6-18/0,75/4A	380	50	0,75	2,1	-	1405	10000	63	F	55
BTFM 630-T/6-16/1,1/4A	380	50	1,1	2,6	-	1410	14000	70	F	55
BTFM 710-T/6-14/1,5/4A	380	50	1,5	3,5	-	1410	17500	71	F	55
BTFM 800-T/6-10/2,2/4A	380	50	2,2	5,0	-	1425	23000	74	F	55
BTFM 800-T/6-14/3/4A	380	50	3	6,6	-	1425	25000	76	F	55
BTFM 900-T/6-12/4/4A	380	50	4	8,4	-	1440	35000	79	F	55
BTFM 900-T/6-16/5,5/4A	380	50	5,5	11,2	-	1465	40000	81	F	55
BTFM 1000-T/6-14/7,5/4A	380	50	7,5	15,4	-	1465	50000	84	F	55
BTFM 1000-T/6-20/11/4A	380	50	11	21,3	-	1465	60000	86	F	55
BTFM 1000-T/6-24/15/4A	380	50	15	29,4	-	1465	70000	87	F	55
BTFM 1000-T/6-28/18,5/4A	380	50	18,5	34,5	-	1470	80000	88	F	55
BTFM 1250-T/6-14/22/4A	380	50	22	42,5	-	1470	100000	94	F	55
BTFM 1250-T/6-20/30/4A	380	50	30	55,0	-	1470	115000	94	F	55

Sound Level Measured from 3m distance in room condition.

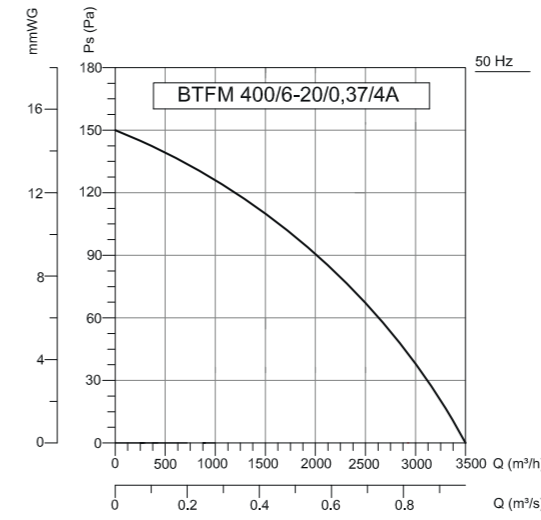

Frequency	Tot	63	125	250	500	1000	2000	4000	8000	Hz
L _{wa} Outlet	78	50	60	68	74	73	70	65	58	dB(A)
L _{wa} In-duct	80	50	63	71	75	75	72	68	62	dB(A)
(3m-Free Field)	60	35	42	51	55	54	53	49	45	dB(A)

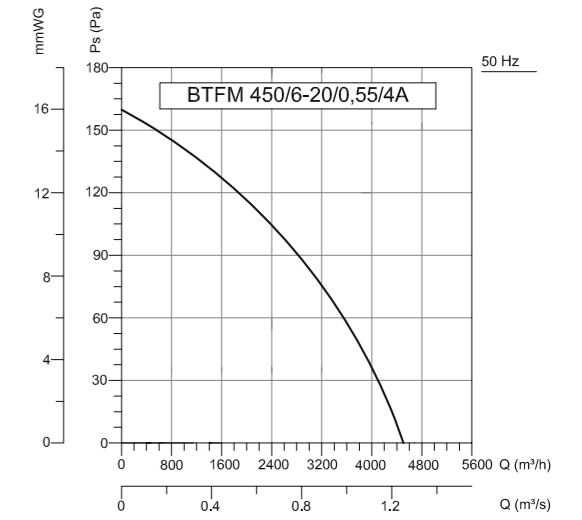

Frequency	Tot	63	125	250	500	1000	2000	4000	8000	Hz
L _{wa} Outlet	80	51	62	70	74	75	73	65	60	dB(A)
L _{wa} In-duct	82	53	64	73	76	77	74	71	65	dB(A)
(3m-Free Field)	62	35	45	52	58	57	54	50	44	dB(A)

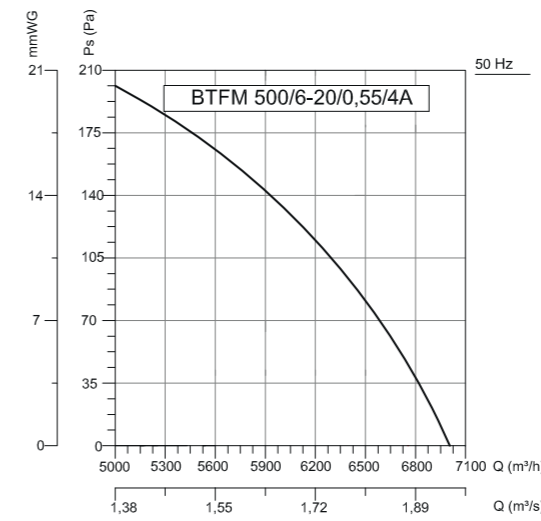

Frequency	Tot	63	125	250	500	1000	2000	4000	8000	Hz
L _{wa} Outlet	83	55	65	74	78	78	76	71	64	dB(A)
L _{wa} In-duct	85	57	67	76	80	80	77	73	66	dB(A)
(3m-Free Field)	66	40	48	56	62	61	58	54	49	dB(A)

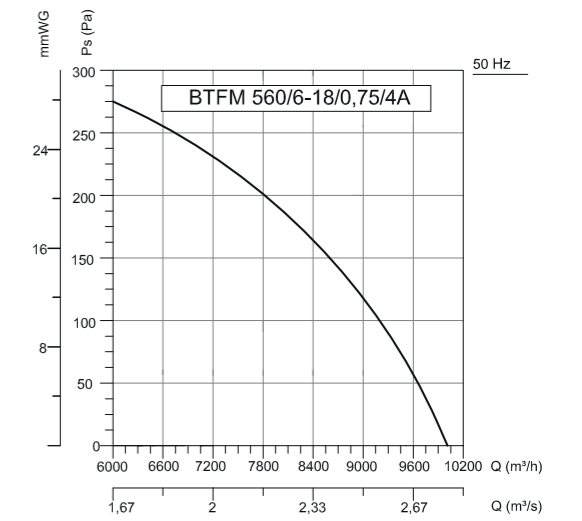

Frequency	Tot	63	125	250	500	1000	2000	4000	8000	Hz
L _{wa} Outlet	81	52	62	71	75	76	73	68	61	dB(A)
L _{wa} In-duct	82	52	64	72	77	77	74	70	63	dB(A)
(3m-Free Field)	63	35	45	53	58	58	55	51	44	dB(A)

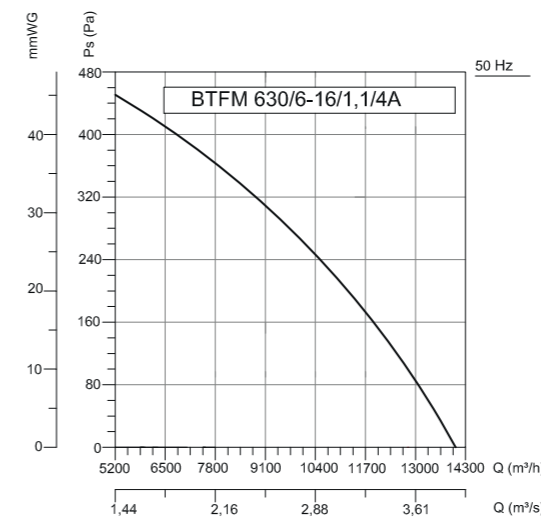

Frequency	Tot	63	125	250	500	1000	2000	4000	8000	Hz
L _{wa} Outlet	88	59	70	79	82	83	79	76	68	dB(A)
L _{wa} In-duct	89	62	71	79	84	84	81	77	70	dB(A)
(3m-Free Field)	70	43	52	61	65	65	63	58	52	dB(A)

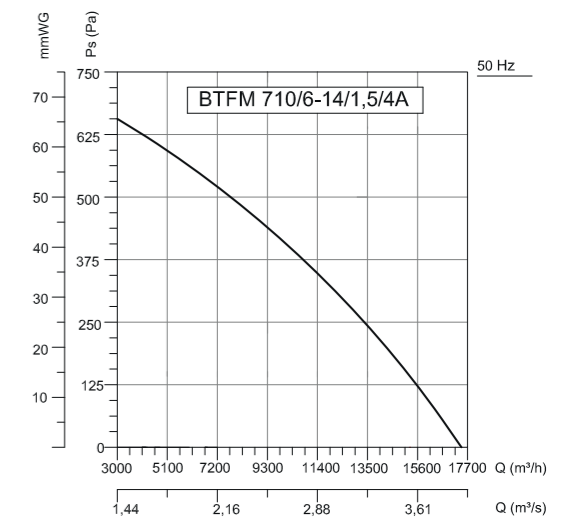

Frequency	Tot	63	125	250	500	1000	2000	4000	8000	Hz
L _{wa} Outlet	88	60	70	78	83	83	80	76	69	dB(A)
L _{wa} In-duct	89	61	71	80	84	84	82	77	70	dB(A)
(3m-Free Field)	71	42	52	61	65	66	63	59	51	dB(A)

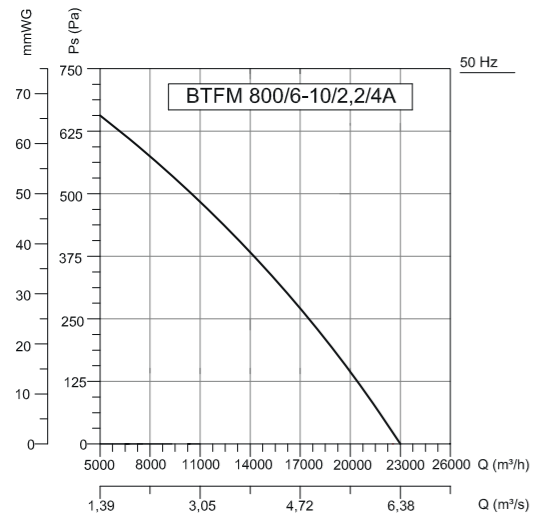

Frequency	Tot	63	125	250	500	1000	2000	4000	8000	Hz
L _{wa} Outlet	91	63	73	82	86	86	83	79	72	dB(A)
L _{wa} In-duct	92	65	74	83	87	87	85	80	74	dB(A)
(3m-Free Field)	74	44	55	64	68	69	66	63	54	dB(A)

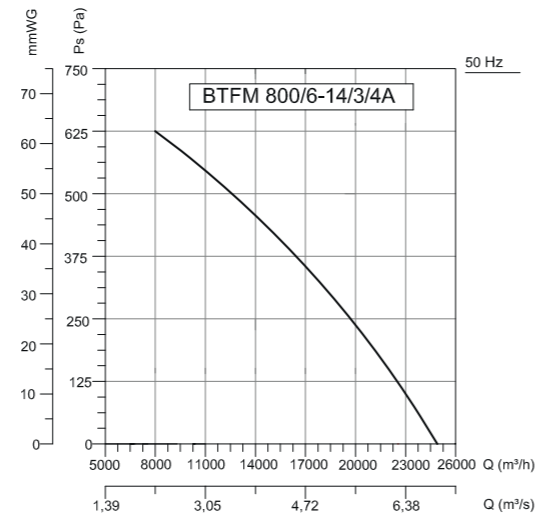

Frequency	Tot	63	125	250	500	1000	2000	4000	8000	Hz
L _{wa} Outlet	93	66	76	84	88	88	86	81	73	dB(A)
L _{wa} In-duct	95	64	75	85	89	90	87	82	74	dB(A)
(3m-Free Field)	76	49	58	66	71	71	68	65	58	dB(A)

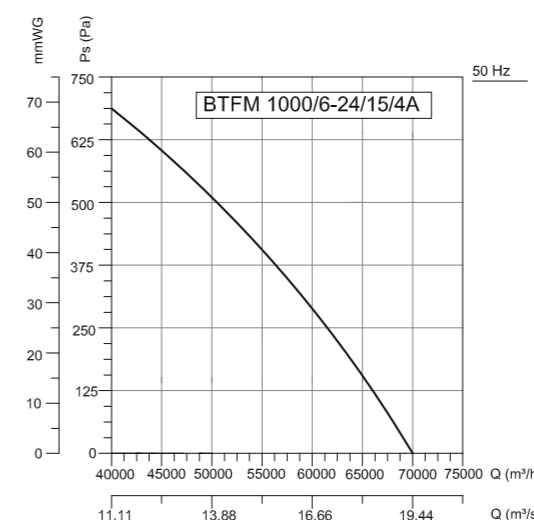

Frequency	Tot	63	125	250	500	1000	2000	4000	8000	Hz
L _{wa} Outlet	105	78	87	95	99	100	97	94	86	dB(A)
L _{wa} In-duct	106	78	87	96	100	101	99	94	85	dB(A)
(3m-Free Field)	87	60	69	78	82	81	79	75	65	dB(A)

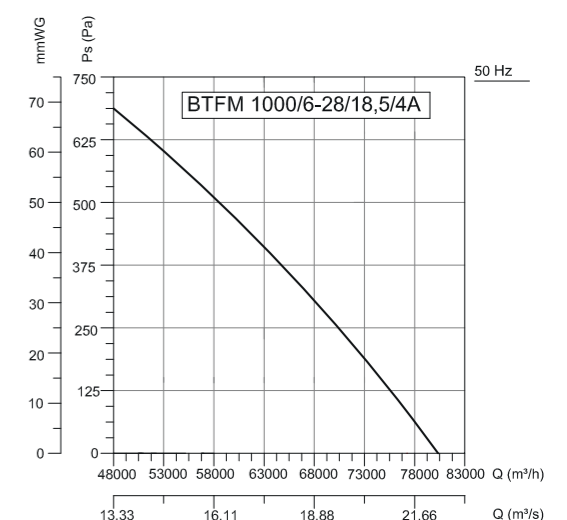

Frequency	Tot	63	125	250	500	1000	2000	4000	8000	Hz
L _{wa} Outlet	106	77	88	96	101	101	98	94	86	dB(A)
L _{wa} In-duct	107	78	88	97	101	102	99	95	88	dB(A)
(3m-Free Field)	88	59	70	79	83	84	80	76	69	dB(A)

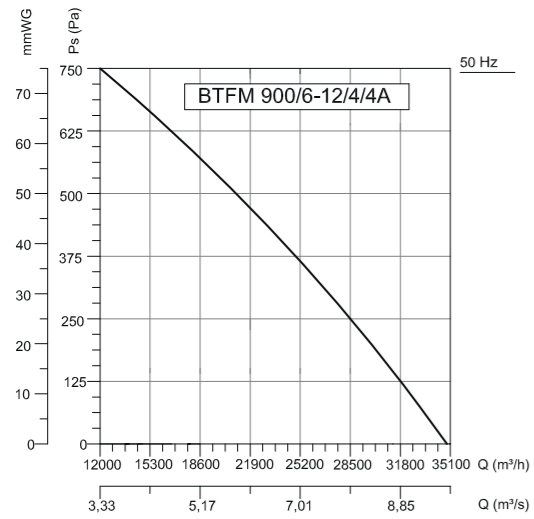

Frequency	Tot	63	125	250	500	1000	2000	4000	8000	Hz
L _{wa} Outlet	96	67	78	87	91	91	89	84	78	dB(A)
L _{wa} In-duct	97	69	79	89	92	92	90	84	77	dB(A)
(3m-Free Field)	79	52	61	69	74	74	71	67	61	dB(A)

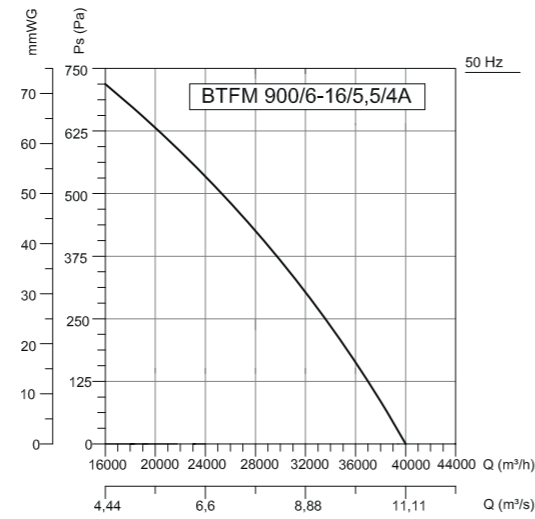

Frequency	Tot	63	125	250	500	1000	2000	4000	8000	Hz
L _{wa} Outlet	98	70	80	89	93	93	91	86	79	dB(A)
L _{wa} In-duct	99	70	88	90	94	94	91	87	79	dB(A)
(3m-Free Field)	81	54	63	71	76	76	73	69	61	dB(A)

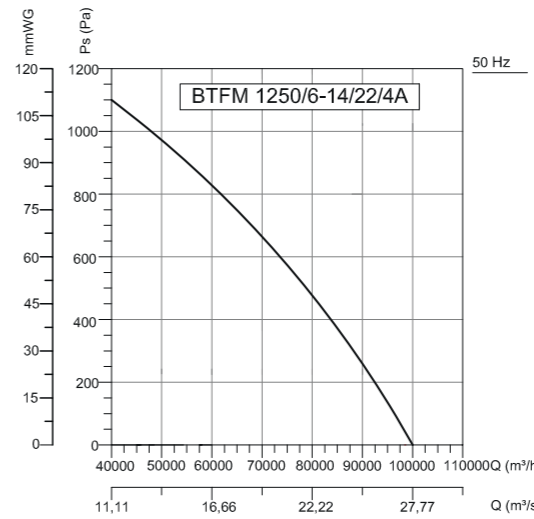

Frequency	Tot	63	125	250	500	1000	2000	4000	8000	Hz
L _{wa} Outlet	112	83	94	102	107	106	104	100	92	dB(A)
L _{wa} In-duct	112	85	94	103	108	107	104	100	93	dB(A)
(3m-Free Field)	94	65	76	86	89	89	87	82	74	dB(A)

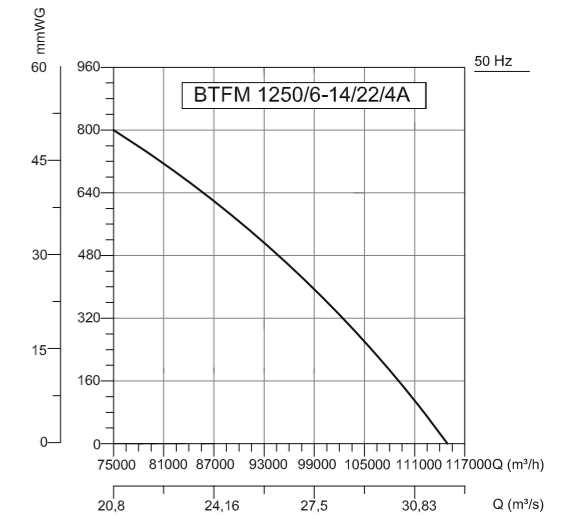

Frequency	Tot	63	125	250	500	1000	2000	4000	8000	Hz
L _{wa} Outlet	112	83	94	102	107	106	104	99	92	dB(A)
L _{wa} In-duct	113	85	94	104	107	108	105	102	93	dB(A)
(3m-Free Field)	94	65	76	85	89	88	87	82	76	dB(A)

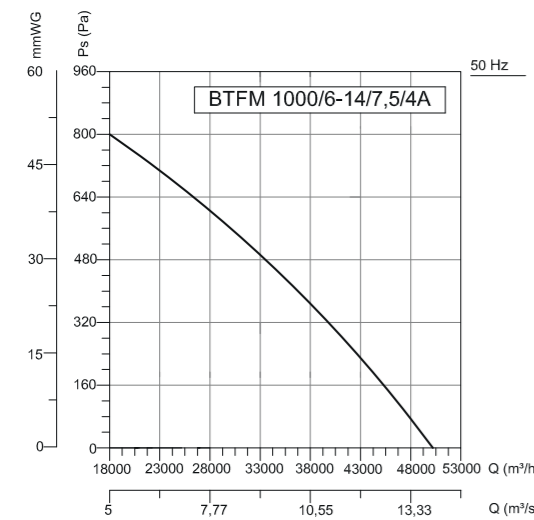

Frequency	Tot	63	125	250	500	1000	2000	4000	8000	Hz
L _{wa} Outlet	102	75	83	92	96	97	93	91	82	dB(A)
L _{wa} In-duct	102	75	84	93	96	97	95	90	82	dB(A)
(3m-Free Field)	84	55	66	74	79	78	76	72	64	dB(A)

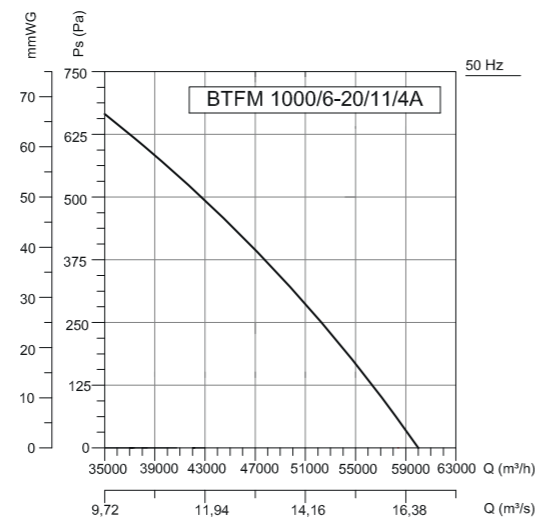

Frequency	Tot	63	125	250	500	1000	2000	4000	8000	Hz
L _{wa} Outlet	103	76	85	94	98	98	96	92	84	dB(A)
L _{wa} In-duct	104	76	86	95	99	98	96	93	85	dB(A)
(3m-Free Field)	86	58	68	76	81	82	78	74	68	dB(A)

Accessories



BSC-F

BESB

BKFB

BSST

BTEK

BTY

BBDD



BTFM-EX

PRESSURATION FANS / Exproof

Fan Components and Material Properties

Cylindrical tube casing, airfoil wing structure and direct coupled motor fans with 3500 m³ / h flow rate of 115000 m³ / h and Ø400 mm -Ø1250 mm 16 models are available in the range options. Body is made of steel with electrostatic powder coating. The motor and fan impeller are connected to the main body by steel carriers. In the case of friction due to the body around the propeller, aluminum sheet is used to prevent sparks. Asynchronous ex-proof motor is used in all models. The motor is out of airflow. It can be manufactured with foot on request.

Fan Structure

Axial wings are produced in pressurized aluminum casting and airfoil structure. The aerodynamically optimized wings provide high efficiency.

Benefits

It works with low noise levels and is designed to be maintenance-free for long periods of time. Speed can be adjusted with speed control devices. The wings are manufactured at the ideal angle and in the form of wings and provide maximum performance.

Speed Control

Optional control devices can be provided. 3-phase products with frequency inverter speed control can be done. (see BSC-F accessory)

Usage Areas

Ex-proof fans are one of the preferred fan types for the ventilation of high-risk environments. It is designed to be non-sparking. Usage areas are determined according to the degree of Atex directive.

Technical Drawing and Tables

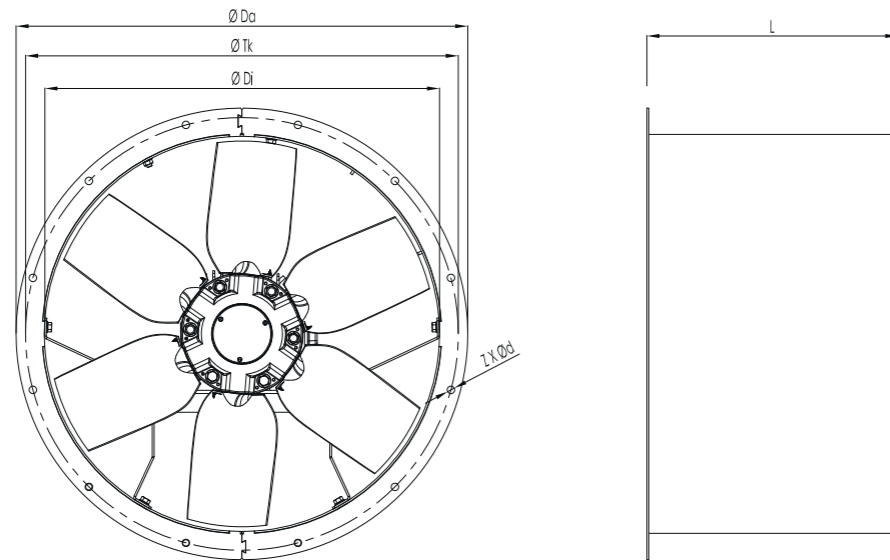

TYPE	ØDi	ØDa	ØTk	ØL	ZXØD
BTFM 400	400	480	450	350	8X12
BTFM 450	450	530	500	350	8X12
BTFM 500	500	590	560	400	12X12
BTFM 560	560	650	620	400	12X12
BTFM 630	630	720	690	400	12X12
BTFM 710	710	800	770	450	16X12
BTFM 800	800	890	860	500	16X12
BTFM 900	900	1005	970	550	16X15
BTFM 1000	1000	1105	1070	700	16X15
BTFM 1250	1250	1390	1320	850	20X15

Dimensions are in (mm)

Accessories



TYPE	VOLTAGE	FREQUENCY	POWER	CURRENT	CAPACITOR	SPEED	AIR FLOW	SOUND PRESSURE	INSULATION CLASS	PROTECTION CLASS
	V	Hz	kW	(A)	(µF)	r.p.m	m ³ /h	dB(A)	Ins.cl.	IP
BTFM 400-T/6-20/EX	380	50	0,37	1,2	-	1390	3500	60	F	55
BTFM 450-T/6-20/EX	380	50	0,55	1,6	-	1365	4500	62	F	55
BTFM 500-T/6-20/EX	380	50	0,55	1,6	-	1365	7000	66	F	55
BTFM 560-T/6-18/EX	380	50	0,75	2,1	-	1405	10000	63	F	55
BTFM 630-T/6-16/EX	380	50	1,1	2,6	-	1410	14000	70	F	55
BTFM 710-T/6-14/EX	380	50	1,5	3,5	-	1410	17500	71	F	55
BTFM 800-T/6-10/EX	380	50	2,2	5,0	-	1425	23000	74	F	55
BTFM 800-T/6-14/EX	380	50	3	6,6	-	1425	25000	76	F	55
BTFM 900-T/6-12/EX	380	50	4	8,4	-	1440	35000	79	F	55
BTFM 900-T/6-16/EX	380	50	5,5	11,2	-	1465	40000	81	F	55
BTFM 1000-T/6-14/EX	380	50	7,5	15,4	-	1465	50000	84	F	55
BTFM 1000-T/6-20/EX	380	50	11	21,3	-	1465	60000	86	F	55
BTFM 1000-T/6-24/EX	380	50	15	29,4	-	1465	70000	87	F	55
BTFM 1000-T/6-28/EX	380	50	18,5	34,5	-	1470	80000	88	F	55
BTFM 1250-T/6-14/EX	380	50	22	42,5	-	1470	100000	94	F	55
BTFM 1250-T/6-20/EX	380	50	30	55,0	-	1470	115000	94	F	55

Sound Level Measured from 3m distance in room condition.

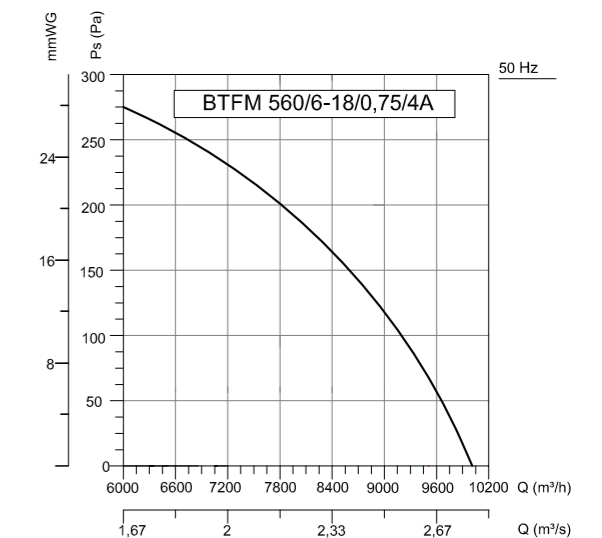
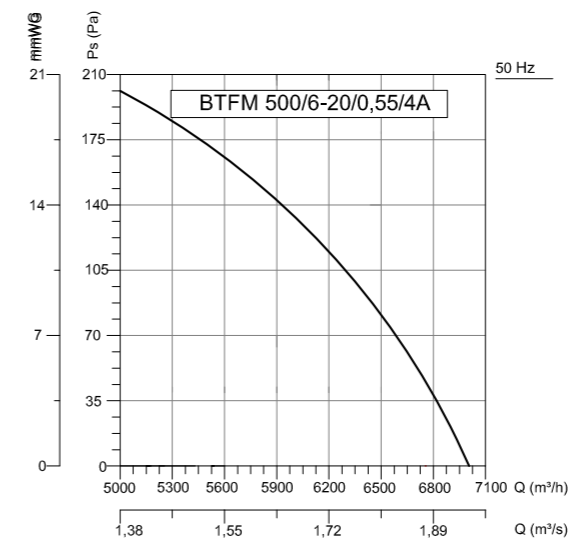
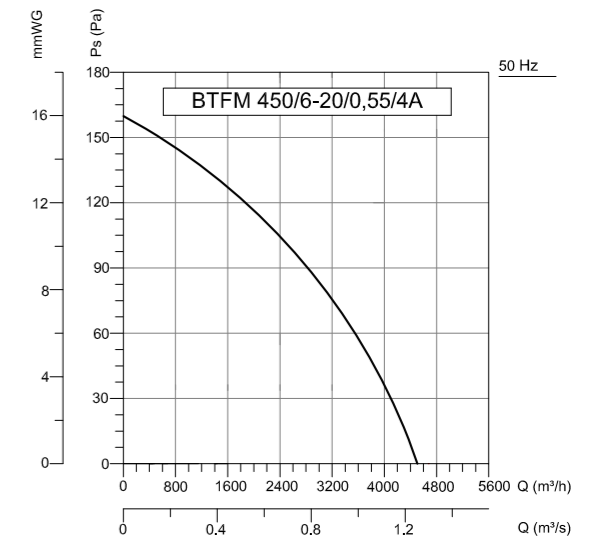
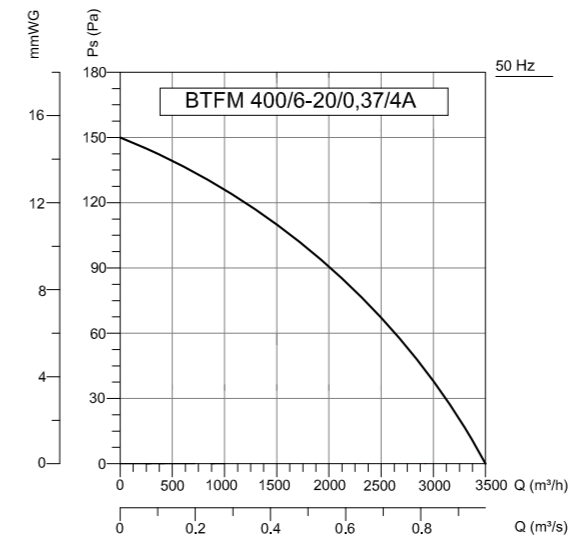

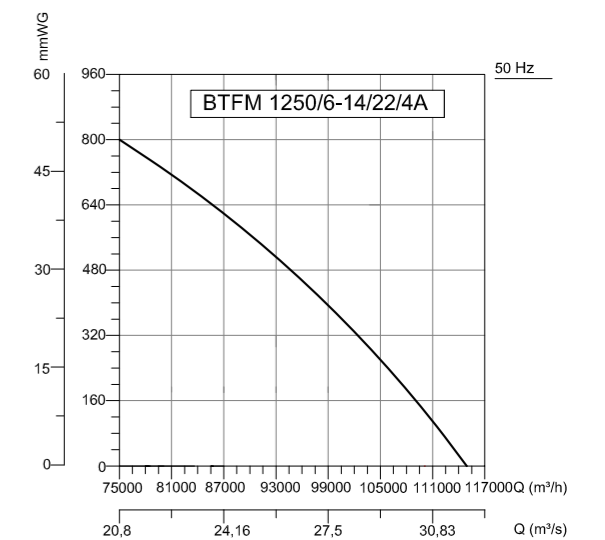
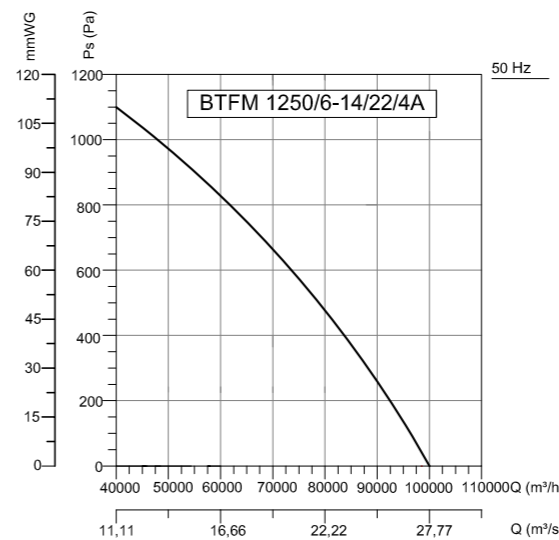
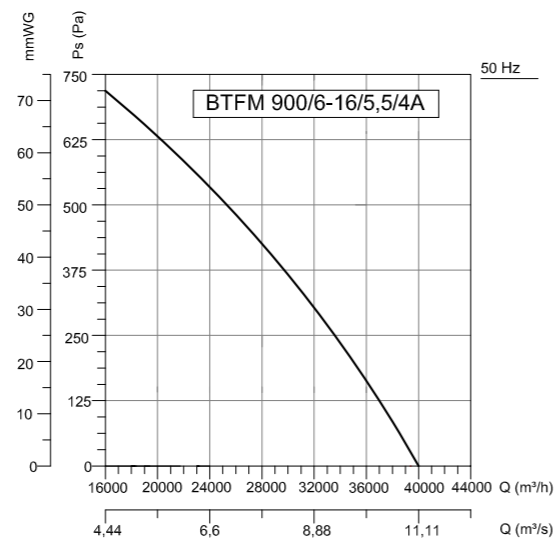
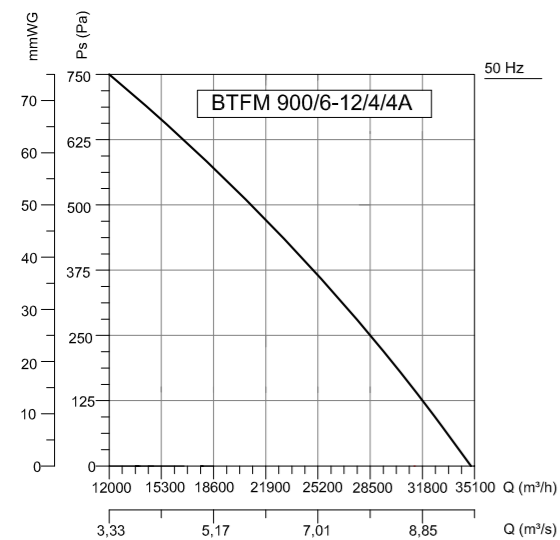
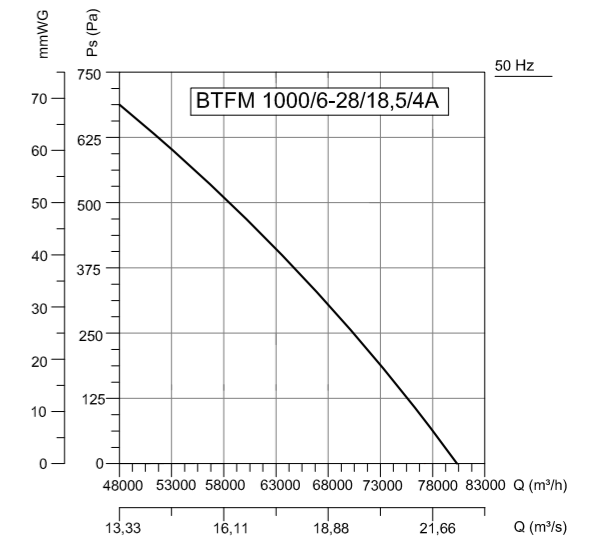
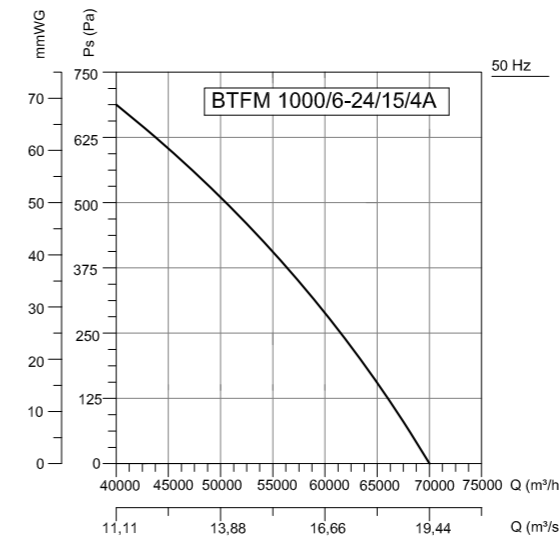
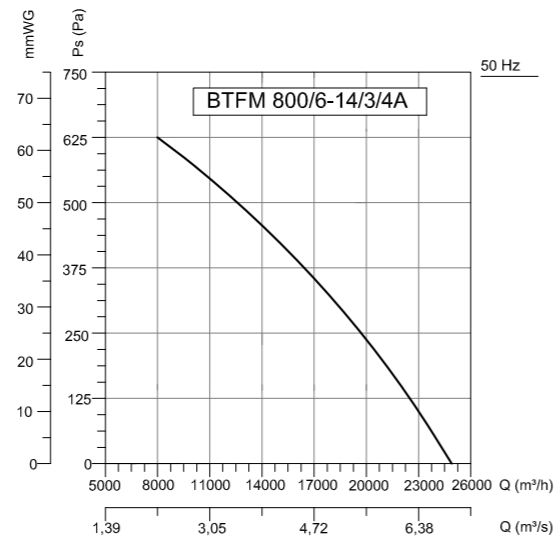
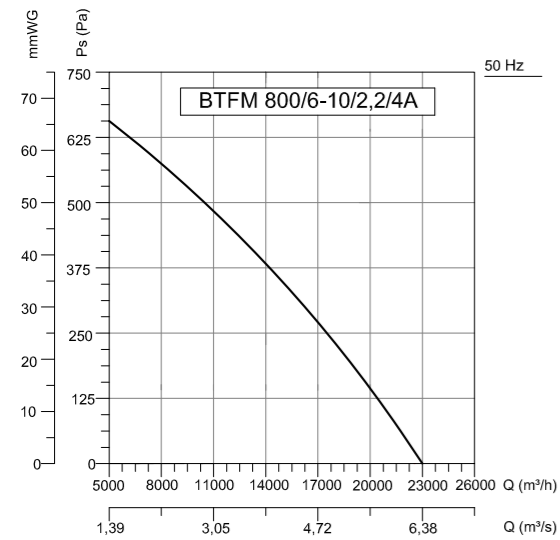
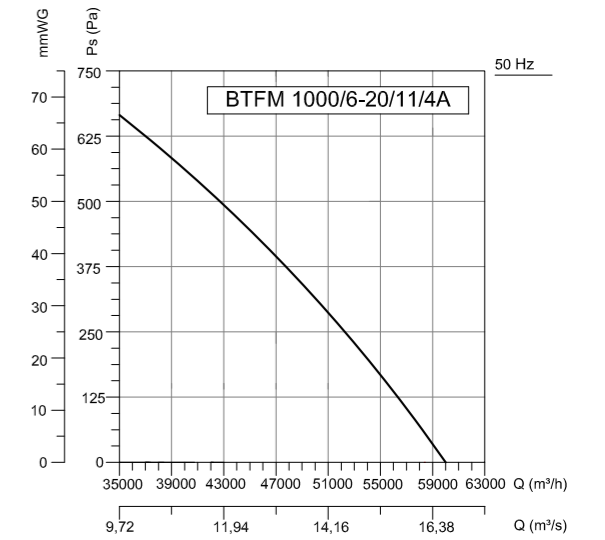
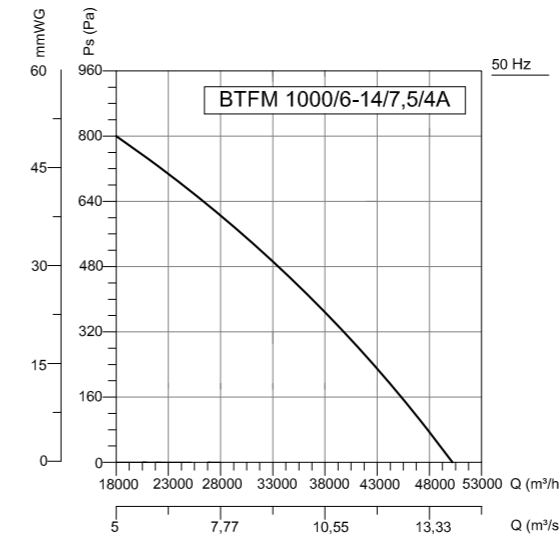
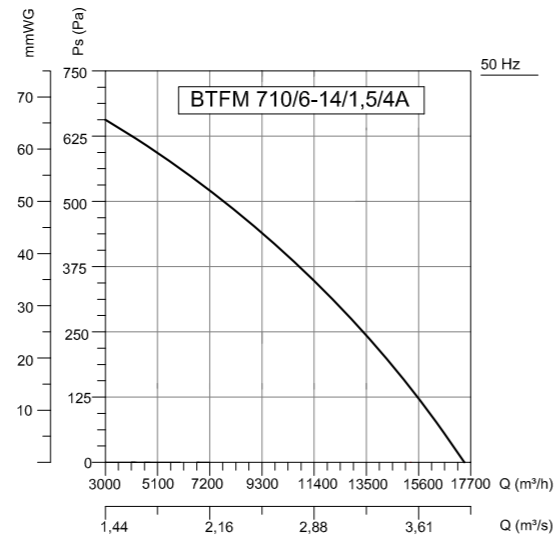
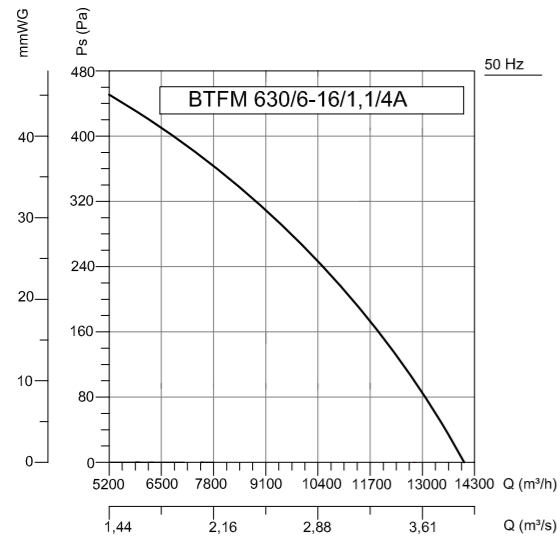



ARMO-A

PRESSURATION FANS / Tube Axial

Axial tube fans are used in pressurization fan, fresh air fan and smoke exhaust fan applications. The fan sleeve is fire resistant and designed according to the noise standard. Smoke evacuation fans are fire resistant. Smoke discharge fans can be installed vertically and horizontally according to the characteristics of the structure.

General Features

EN 12101-3 and CE certificates. 2 hours continuous operation at 400 C and 300 C. There is a wide product range from 400 mm to 1250 mm.

Rotor Features

Fire resistant aluminum alloy casting blades and fan hub. It is capable of one-way and two-way operation. The blades are specially designed according to each direction type. There is no aerodynamic loss in the case of reversible wing type operation. Wings are airfoil and provide high aerodynamic performance in both unidirectional and bidirectional vanes. Wing angles are adjustable. In this way, smoke discharge fans can be demanded at different flow rates and pressures. The fan part of the fan is balanced dynamically to ISO 1940 and there is no eccentricity during the operation of the fan.

Body Features

Fan body is steel sheet. Body is hot dip galvanized and corrosion resistant. It has short type body and long type body types.

Motor Features

Offers 2.4 and 6-pole motors. The motors are IP 55 class and Class-H insulated. All electric motor models are approved for continuous operation (S1) and Emergency operation (S2).

Ease of Maintenance

A maintenance cover is provided to ensure easy maintenance.

Usage Areas

They are the fans that provide the combustion of toxic gases that are supplied by the jet fans to the external environment. Axial fans are used in pressurization fan, fresh air fan and smoke exhaust fan applications.

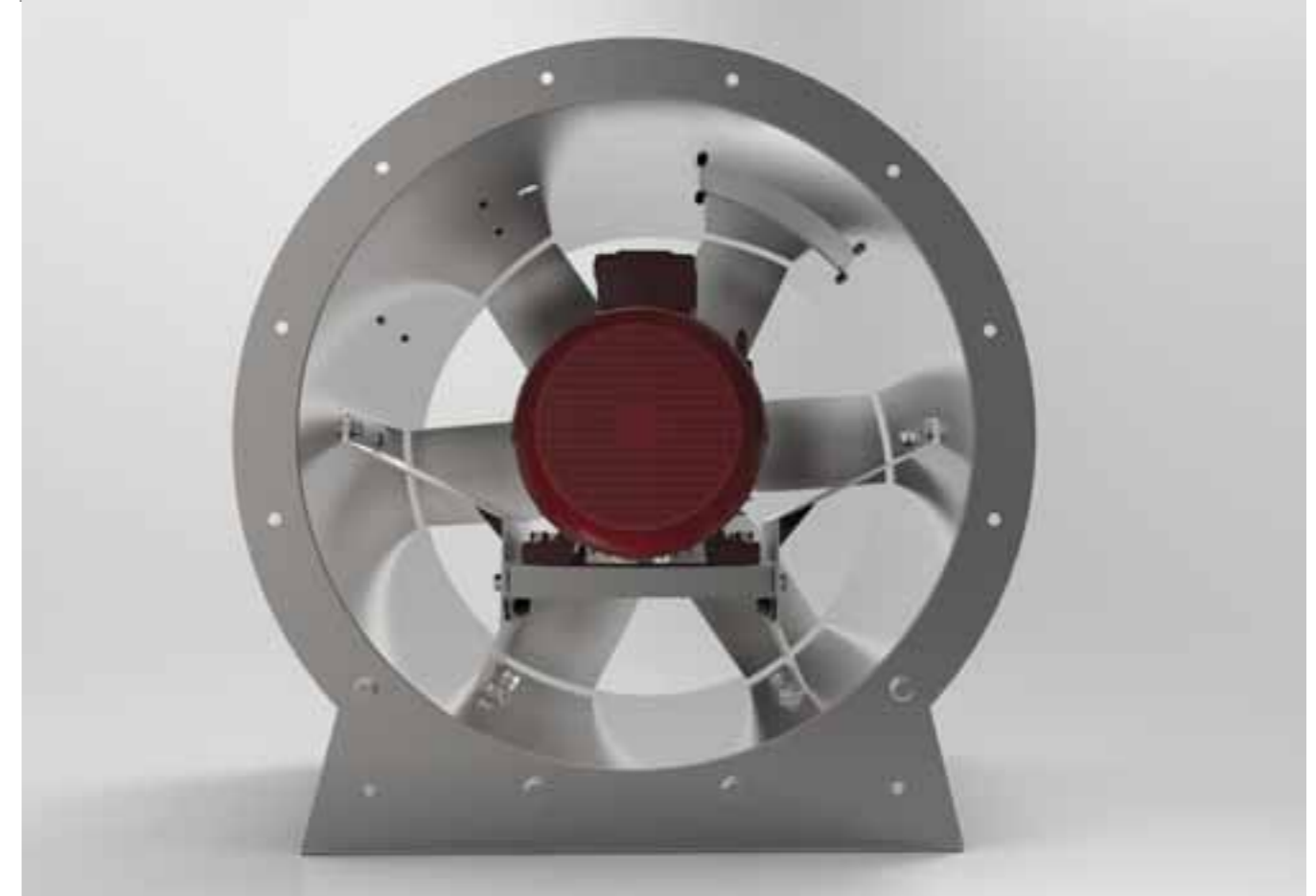

Technical Drawing and Tables

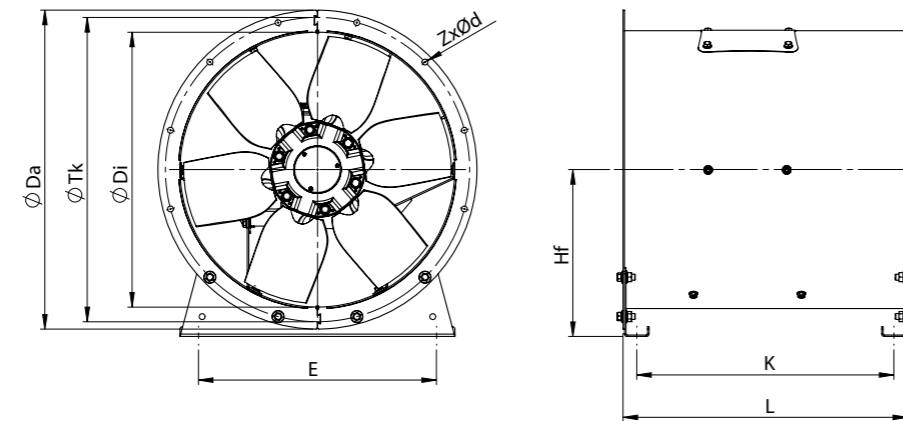

TYPE	ØDi	ØDa	ØTk	ZxØd	L	Hf	K	E
ARMO-A 400	400	480	450	8xØ12	474	255	420	335
ARMO-A 450	450	530	500	8xØ12	474	280	420	385
ARMO-A 500	500	590	560	12xØ12	580	310	524	425
ARMO-A 560	560	650	620	12xØ12	580	340	524	485
ARMO-A 630	630	720	690	12xØ12	600	375	544	555
ARMO-A 710	710	800	770	16xØ12	600	420	544	595
ARMO-A 800	800	890	860	16xØ12	700	470	634	625
ARMO-A 900	900	1005	970	16xØ15	775	527	697	675
ARMO-A 1000	1000	1105	1070	16xØ15	850	577	772	775
ARMO-A 1250	1250	1390	1320	20xØ15	949	720	861	950

Dimensions are in (mm)

TYPE	2 POLE					
	SPEED r.p.m	DIAMETER mm	POWER kW	CURRENT 230V - 400V	AIR FLOW m ³ /h	WING ANGLE
ARMO-A / 400-6 / 0,75 - 2A	2900	400	0,75	1,6	5250	16°
ARMO-A / 400-6 / 1,1 - 2A	2900	400	1,1	2,3	6904	22°
ARMO-A / 400-6 / 1,5 - 2A	2900	400	1,5	3,4	8978	30°
ARMO-A / 400-6 / 2,2 - 2A	2900	400	2,2	4,48	9975	34°
ARMO-A / 450-6 / 1,1 - 2A	2900	450	1,1	2,3	6248	10°
ARMO-A / 450-6 / 1,5 - 2A	2900	450	1,5	3,4	8610	16°
ARMO-A / 450-6 / 2,2 - 2A	2900	450	2,2	4,48	11970	24°
ARMO-A / 450-6 / 3 - 2A	2900	450	3	6	13545	28°
ARMO-A / 500-6 / 2,2 - 2A	2900	500	2,2	4,48	11000	14°
ARMO-A / 500-6 / 3 - 2A	2900	500	3	6	14595	20°
ARMO-A / 500-6 / 4 - 2A	2900	500	4	7,4	17325	26°
ARMO-A / 500-6 / 5,5 - 2A	2900	500	5,5	11	18375	28°
ARMO-A / 560-6 / 4 - 2A	2900	560	4	7,4	17850	14°
ARMO-A / 560-6 / 5,5 - 2A	2900	560	5,5	11	22313	20°
ARMO-A / 560-6 / 7,5 - 2A	2800	560	7,5	13,6	25725	24°
ARMO-A / 630-6 / 5,5 - 2A	2900	630	5,5	11	20475	10°
ARMO-A / 630-6 / 7,5 - 2A	2800	630	7,5	13,6	27300	16°

Sound Level Measured from 3m distance in room condition.

4 POLE TYPE	SPEED	DIAMETER	POWER	CURRENT	AIR FLOW	WING ANGLE
	r.p.m	mm	kW	230V - 400V	m ³ /h	
ARMO-A / 500-6 / 0,55- 4A	1415	500	0,55	1,6	8715	26
ARMO-A / 500-6 / 0,75- 4A	1350	500	0,75	2,1	10290	32
ARMO-A / 500-6 / 1,1- 4A	1400	500	1,1	2,6	12600	38
ARMO-A / 560-6 / 0,55- 4A	1415	560	0,55	1,6	9870	16
ARMO-A / 560-6 / 0,75- 4A	1350	560	0,75	2,1	12075	22
ARMO-A / 560-6 / 1,1- 4A	1400	560	1,1	2,6	13860	26
ARMO-A / 560-6 / 1,5- 4A	1405	560	1,5	3,5	15750	32
ARMO-A / 560-6 / 2,2- 4A	1410	560	2,2	5	17850	38
ARMO-A / 630-6 / 0,75- 4A	1350	630	0,75	2,1	10605	10
ARMO-A / 630-6 / 1,1- 4A	1400	630	1,1	2,6	16275	20
ARMO-A / 630-6 / 1,5- 4A	1405	630	1,5	3,5	18375	24
ARMO-A / 630-6 / 2,2- 4A	1410	630	2,2	5	21525	30
ARMO-A / 630-6 / 3- 4A	1410	630	3	6,6	24150	36
ARMO-A / 630-6 / 4- 4A	1500	630	4	8,2	25200	38
ARMO-A / 710-3 / 0,75- 4A	1350	710	0,75	2,1	14175	10
ARMO-A / 710-3 / 1,1- 4A	1400	710	1,1	2,6	18375	16
ARMO-A / 710-3 / 1,5- 4A	1405	710	1,5	3,5	21000	20
ARMO-A / 710-3 / 2,2- 4A	1410	710	2,2	5	24413	26
ARMO-A / 710-3 / 3- 4A	1410	710	3	6,6	27825	32
ARMO-A / 710-6 / 1,1- 4A	1400	710	1,1	2,6	16275	12
ARMO-A / 710-6 / 1,5- 4A	1405	710	1,5	3,5	20475	18
ARMO-A / 710-6 / 2,2- 4A	1410	710	2,2	5	23625	22
ARMO-A / 710-6 / 3- 4A	1410	710	3	6,6	28350	28
ARMO-A / 710-6 / 4- 4A	1415	710	4	8,2	31500	32
ARMO-A / 800-6 / 2,2- 4A	1410	800	2,2	5	24150	14
ARMO-A / 800-6 / 3- 4A	1410	800	3	6,6	30450	20
ARMO-A / 800-6 / 4- 4A	1415	800	4	8,2	32550	22
ARMO-A / 800-6 / 5,5- 4A	1430	800	5,5	11,2	38850	28
ARMO-A / 800-6 / 7,5- 4A	1440	800	7,5	15,4	42525	32
ARMO-A / 800-9 / 2,2- 4A	1410	800	2,2	5	16275	10
ARMO-A / 800-9 / 3- 4A	1410	800	3	6,6	21525	14
ARMO-A / 800-9 / 4- 4A	1415	800	4	8,2	29400	20
ARMO-A / 800-9 / 5,5- 4A	1430	800	5,5	11,2	36488	26
ARMO-A / 800-9 / 7,5- 4A	1440	800	7,5	15,4	40950	30
ARMO-A / 800-9 / 11- 4A	1450	800	11	21	43050	32
ARMO-A / 900-6 / 4- 4A	1415	900	4	8,2	31500	12
ARMO-A / 900-6 / 5,5- 4A	1430	900	5,5	11,2	38850	16
ARMO-A / 900-6 / 7,5- 4A	1440	900	7,5	15,4	47775	22
ARMO-A / 900-6 / 11- 4A	1450	900	11	21	56700	28
ARMO-A / 900-6 / 15- 4A	1450	900	15	29,3	60900	32
ARMO-A / 900-9 / 4- 4A	1415	900	4	8,2	26775	10
ARMO-A / 900-9 / 5,5- 4A	1430	900	5,5	11,2	34125	14
ARMO-A / 900-9 / 7,5- 4A	1440	900	7,5	15,4	41213	18
ARMO-A / 900-9 / 11- 4A	1450	900	11	21	54600	26
ARMO-A / 900-9 / 15- 4A	1450	900	15	29,3	63525	32
ARMO-A / 1000-6 / 5,5- 4A	1430	1000	5,5	11,2	38850	12
ARMO-A / 1000-6 / 7,5- 4A	1440	1000	7,5	15,4	47775	18
ARMO-A / 1000-6 / 11- 4A	1450	1000	11	21	56700	22
ARMO-A / 1000-6 / 15- 4A	1450	1000	15	29,3	60900	28
ARMO-A / 1000-6 / 18,5- 4A	1455	1000	18,5	34,5	56700	32
ARMO-A / 1000-9 / 7,5- 4A	1440	1000	7,5	15,4	43050	12
ARMO-A / 1000-9 / 11- 4A	1450	1000	11	21	55650	18
ARMO-A / 1000-9 / 15- 4A	1450	1000	15	29,3	69300	24
ARMO-A / 1000-9 / 18,5- 4A	1455	1000	18,5	34,5	77700	28
ARMO-A / 1000-9 / 22- 4A	1460	1000	22	42,5	81900	30
ARMO-A / 1000-9 / 30- 4A	1460	1000	30	55	86100	32
ARMO-A / 1250-6 / 15- 4A	1450	1250	15	29,3	90300	12
ARMO-A / 1250-6 / 18,5- 4A	1455	1250	18,5	34,5	103950	16
ARMO-A / 1250-6 / 22- 4A	1460	1250	22	42,5	109725	18
ARMO-A / 1250-6 / 30- 4A	1460	1250	30	55	122850	22
ARMO-A / 1250-6 / 37- 4A	1470	1250	37	67	136500	26
ARMO-A / 1250-6 / 45- 4A	1475	1250	45	80	155400	32
ARMO-A / 1250-9 / 18,5- 4A	1455	1250	18,5	34,5	89250	12
ARMO-A / 1250-9 / 22- 4A	1460	1250	22	42,5	97650	14
ARMO-A / 1250-9 / 30- 4A	1460	1250	30	55	114975	18
ARMO-A / 1250-9 / 37- 4A	1470	1250	37	67	131250	22
ARMO-A / 1250-9 / 45- 4A	1475	1250	45	80	138600	24

6 POLE TYPE	SPEED	DIAMETER	POWER	CURRENT	AIR FLOW	WING ANGLE
	r.p.m	mm	kW	230V - 400V	m ³ /h	
ARMO-A / 500-6 / 0,37- 6A	900	500	0,37	1,1	8400	38
ARMO-A / 560-6 / 0,37- 6A	900	560	0,37	1,1	10500	32
ARMO-A / 560-6 / 0,55- 6A	930	560	0,55	1,5	11760	38
ARMO-A / 630-6 / 0,37- 6A	900	630	0,37	1,1	11576	22
ARMO-A / 630-6 / 0,55- 6A	930	630	0,55	1,5	13650	28
ARMO-A / 630-6 / 0,75- 6A	945	630	0,75	2	14963	32
ARMO-A / 630-6 / 1,1- 6A	945	630	1,1	2,9	16800	38
ARMO-A / 710-3 / 0,37- 6A	900	710	0,37	1,1	13125	18
ARMO-A / 710-3 / 0,55- 6A	930	710	0,55	1,5	16538	26
ARMO-A / 710-3 / 0,75- 6A	945	710	0,75	2	18900	32
ARMO-A / 710-6 / 1,1- 6A	945	710	1,1	2,9	11025	12
ARMO-A / 710-6 / 1,5- 6A	945	710	1,5	3,6	13000	16
ARMO-A / 710-6 / 2,2- 6A	950	710	2,2	5,4	13750	22
ARMO-A / 710-6 / 3- 6A	950	710	3	6,9	18900	28
ARMO-A / 710-6 / 4- 6A	955	710	4	9	21000	32
ARMO-A / 800-6 / 0,55- 6A	930	800	0,55		13125	10
ARMO-A / 800-6 / 1,1- 6A	945	800	1,1	2,9	22050	22
ARMO-A / 800-6 / 1,5- 6A	945	800	1,5	3,6	25200	26
ARMO-A / 800-6 / 2,2- 6A	950	800	2,2	5,4	28350	32
ARMO-A / 800-9 / 0,75- 6A	945	800	0,75	2	14700	14
ARMO-A / 800-9 / 1,1- 6A	945	800	1,1	2,9	19950	20
ARMO-A / 800-9 / 1,5- 6A	945	800	1,5	3,6	23100	24
ARMO-A / 800-9 / 2,2- 6A	950	800	2,2	5,4	27300	30
ARMO-A / 800-9 / 3- 6A	950	800	3	6,9	28350	32
ARMO-A / 900-6 / 1,1- 6A	945	900	1,1	2,9	23100	14
ARMO-A / 900-6 / 1,5- 6A	945	900	1,5	3,6	25200	16
ARMO-A / 900-6 / 2,2- 6A	950	900	2,2	5,4	31500	22
ARMO-A / 900-6 / 3- 6A	950	900	3	6,9	36750	28
ARMO-A / 900-6 / 4- 6A	955	900	4	9	40950	32
ARMO-A / 900-9 / 1,5- 6A	945	900	1,5	3,6	23100	14
ARMO-A / 900-9 / 2,2- 6A	950	900	2,2	5,4	27300	20
ARMO-A / 900-9 / 3- 6A	950	900	3	6,9	35700	24
ARMO-A / 900-9 / 4- 6A	955	900	4	9	39900	30
ARMO-A / 900-9 / 5,5- 6A	985	900	5,5	12,3	43050	32
ARMO-A / 1000-6 / 1,5- 6A	945	1000	1,5	3,6	26250	10
ARMO-A / 1000-6 / 2,2- 6A	950	1000	2,2	5,4	34650	16
ARMO-A / 1000-6 / 3- 6A	950	1000	3	6,9	44100	22
ARMO-A / 1000-6 / 4- 6A	955	1000	4	9	49350	26
ARMO-A / 1000-6 / 5,5- 6A	985	1000	5,5	12,3	55650	32
ARMO-A / 1000-9 / 2,2- 6A	950	1000	2,2	5,4	32550	14
ARMO-A / 1000-9 / 3- 6A	950	1000	3	6,9	39900	20
ARMO-A / 1000-9 / 4- 6A	955	1000	4	9	43050	22
ARMO-A / 1000-9 / 5,5- 6A	985	1000	5,5	12,3	52500	28
ARMO-A / 1000-9 / 7,5- 6A	960	1000	7,5	15	57750	32
ARMO-A / 1250-6 / 4- 6A	955	1250	4	9	60900	12
ARMO-A / 1250-6 / 5,5- 6A	985	1250	5,5	12,3	63300	16
ARMO-A / 1250-6 / 7,5- 6A	960	1250	7,5	15	76650	20
ARMO-A / 1250-6 / 11- 6A	960	1250	11	22	92400	26
ARMO-A / 1250-6 / 15- 6A	965	1250	15	29	105000	32
ARMO-A / 1250-9 / 7,5- 6A	960	1250	7,5	15	73500	16
ARMO-A / 1250-9 / 11- 6A	960	1250	11	22	88200	22
ARMO-A / 1250-9 / 15- 6A	965	1250	15	29	105000	28
ARMO-A / 1250-9 / 18,5- 6A	970	1250	18,5	36,5	115500	32

Accessories



BSC-F BESB BKFB BSST BTEK BTY BBDD

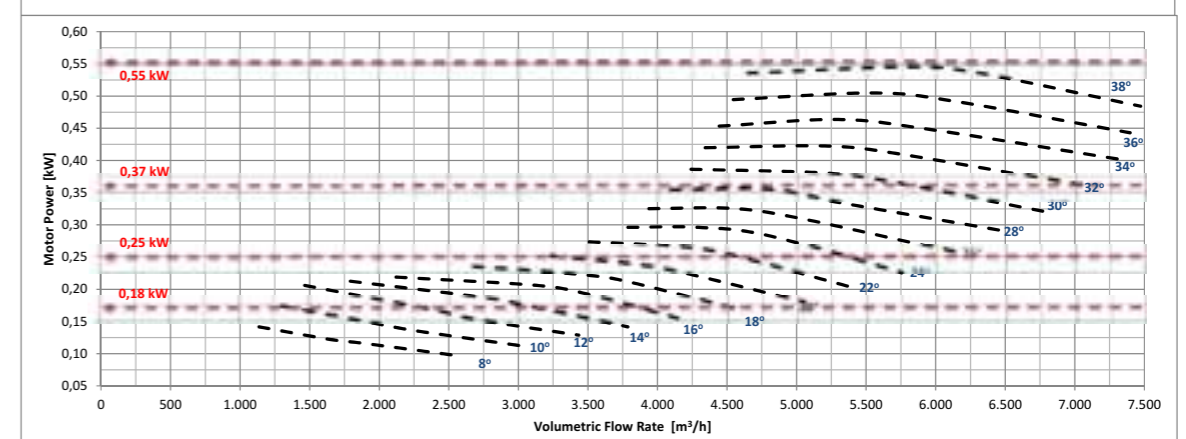
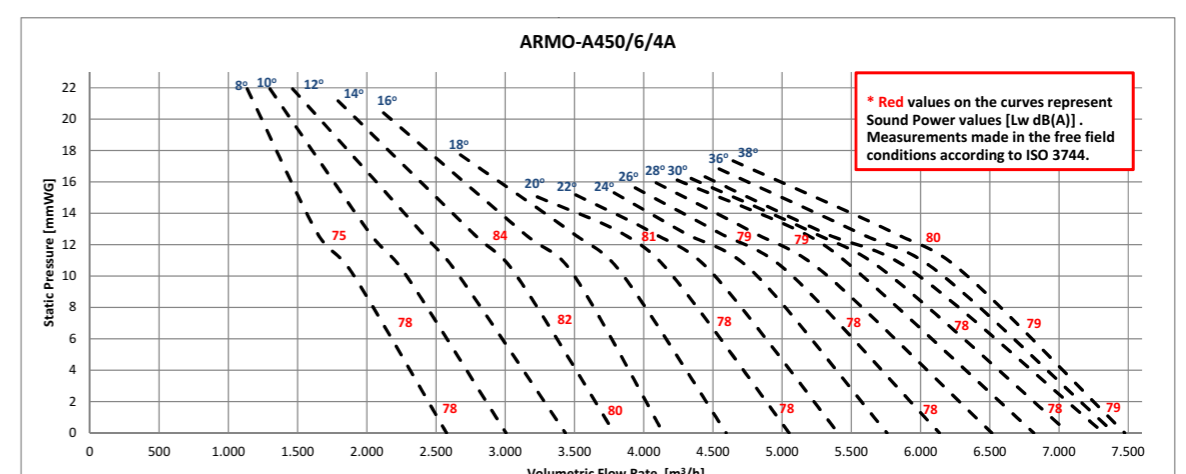
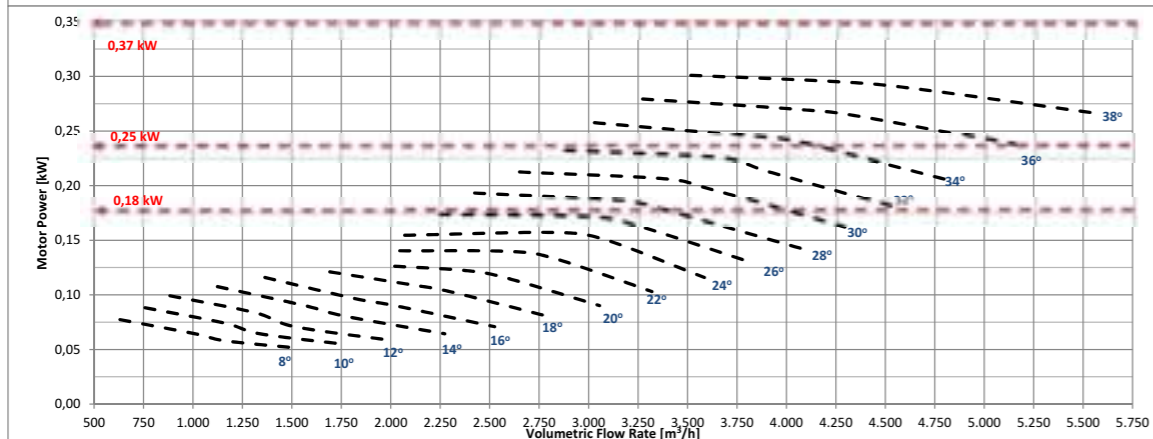
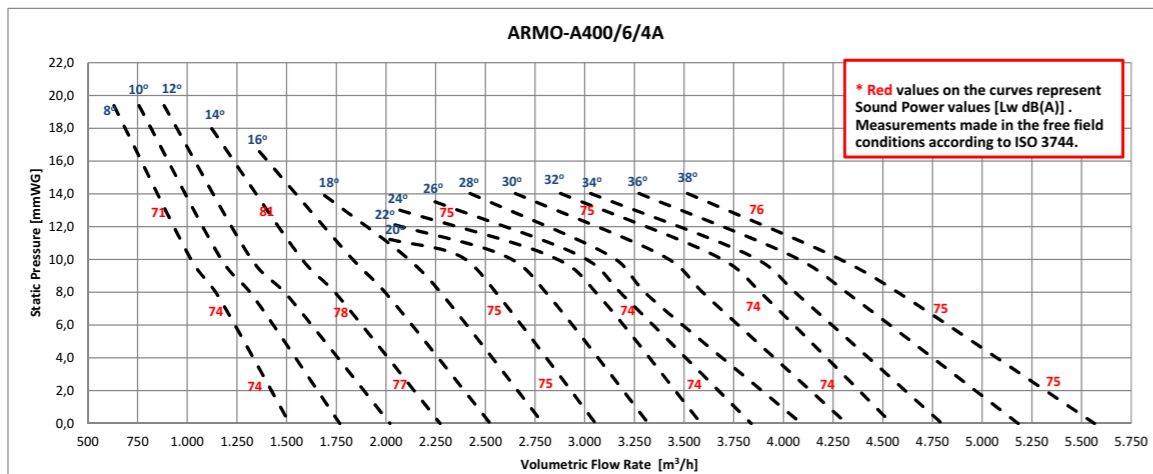
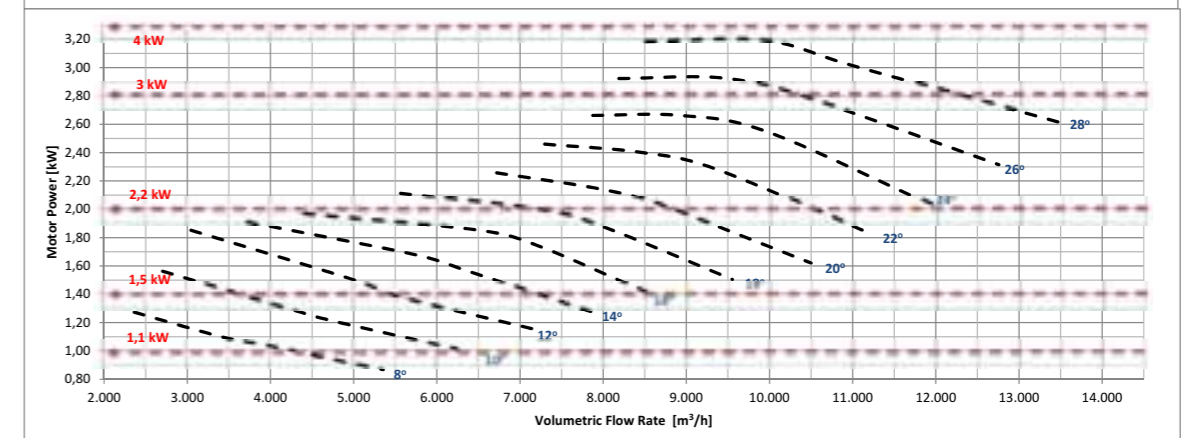
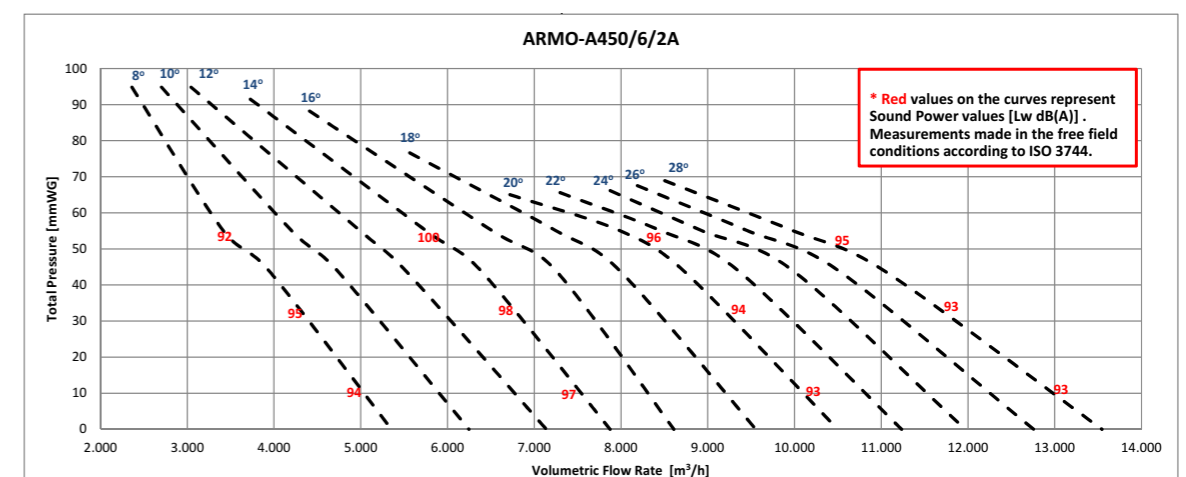
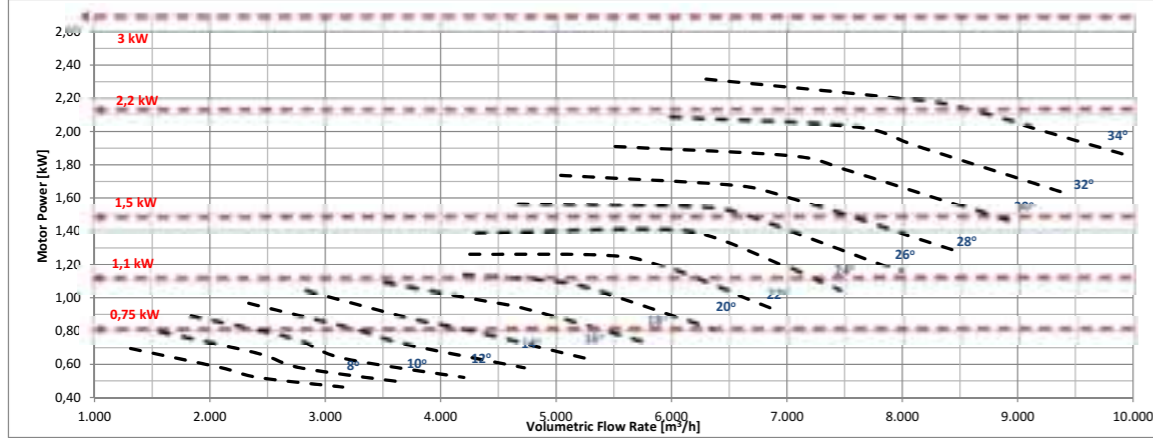
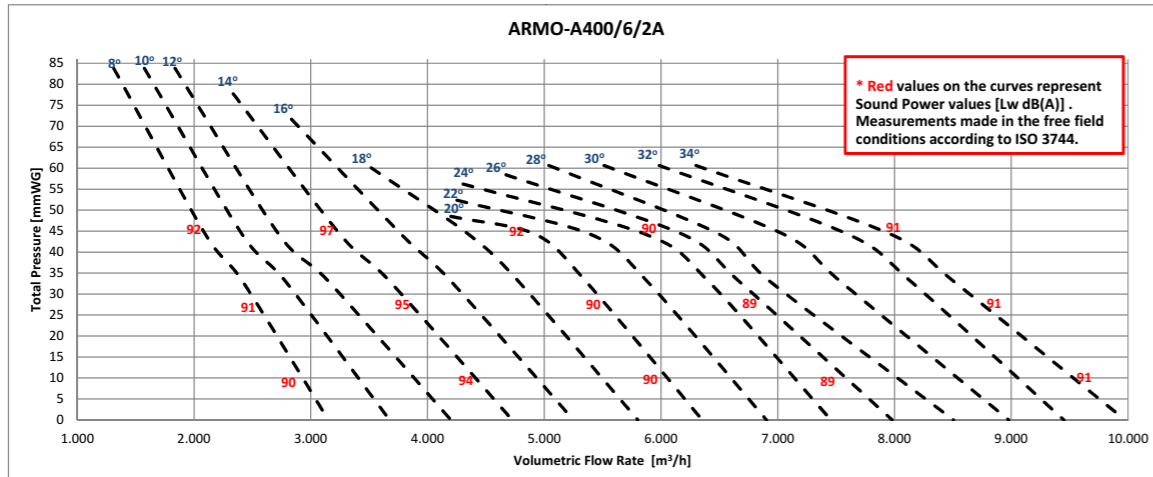

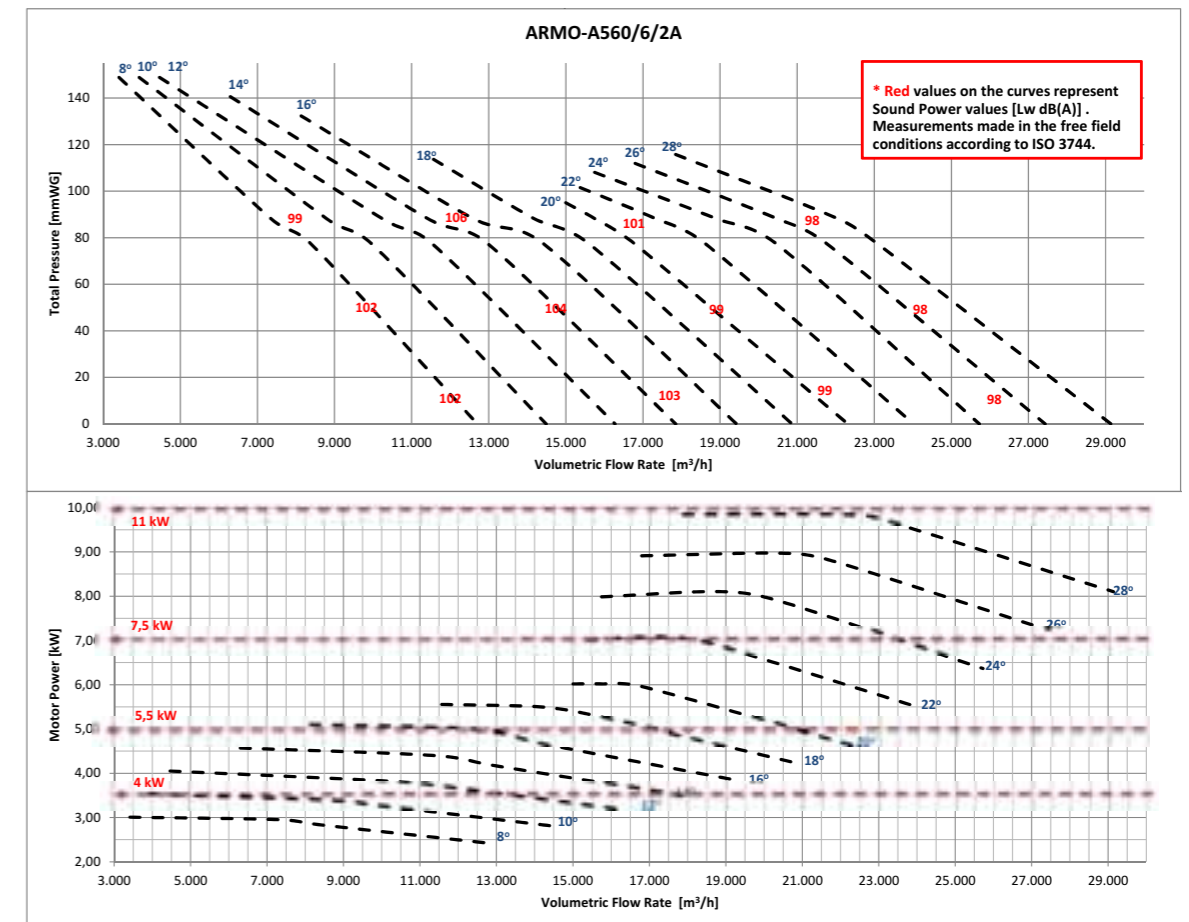
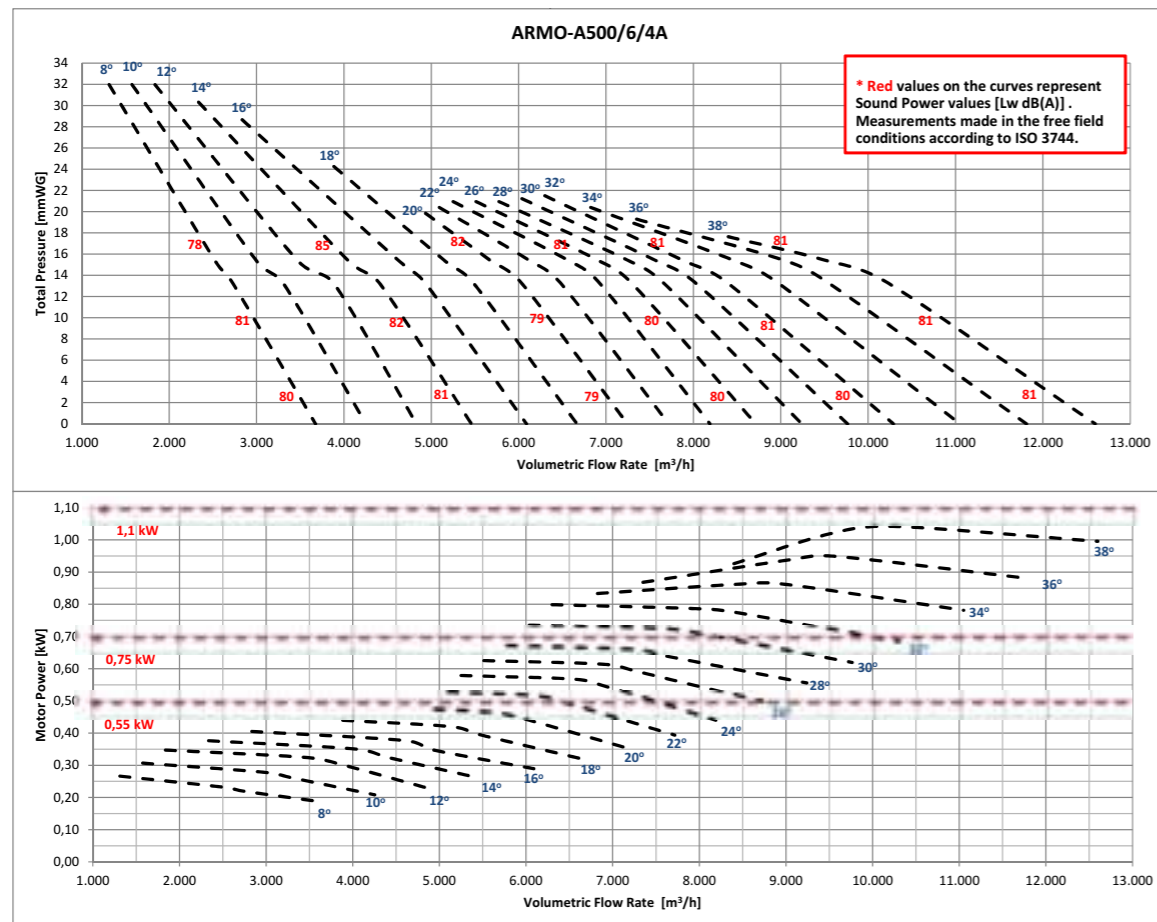
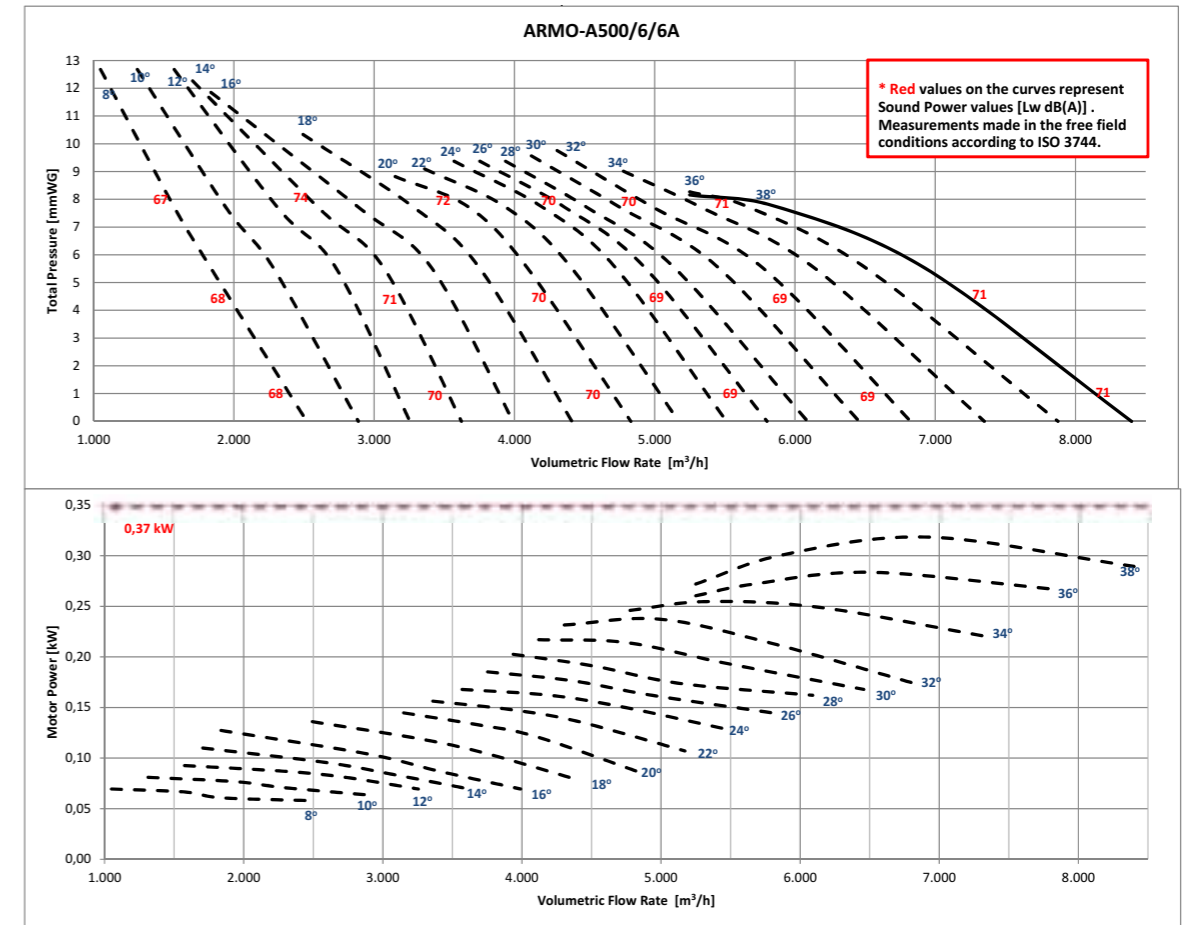
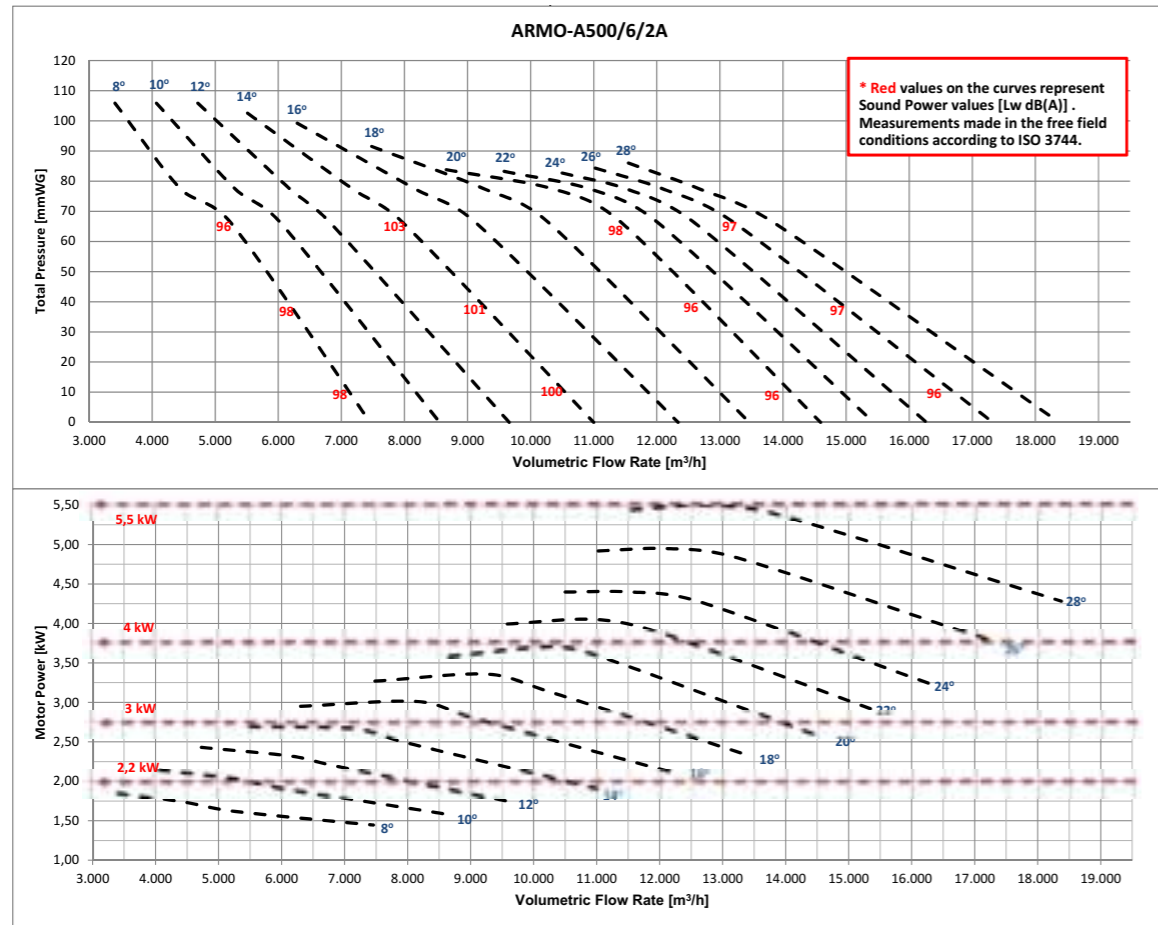

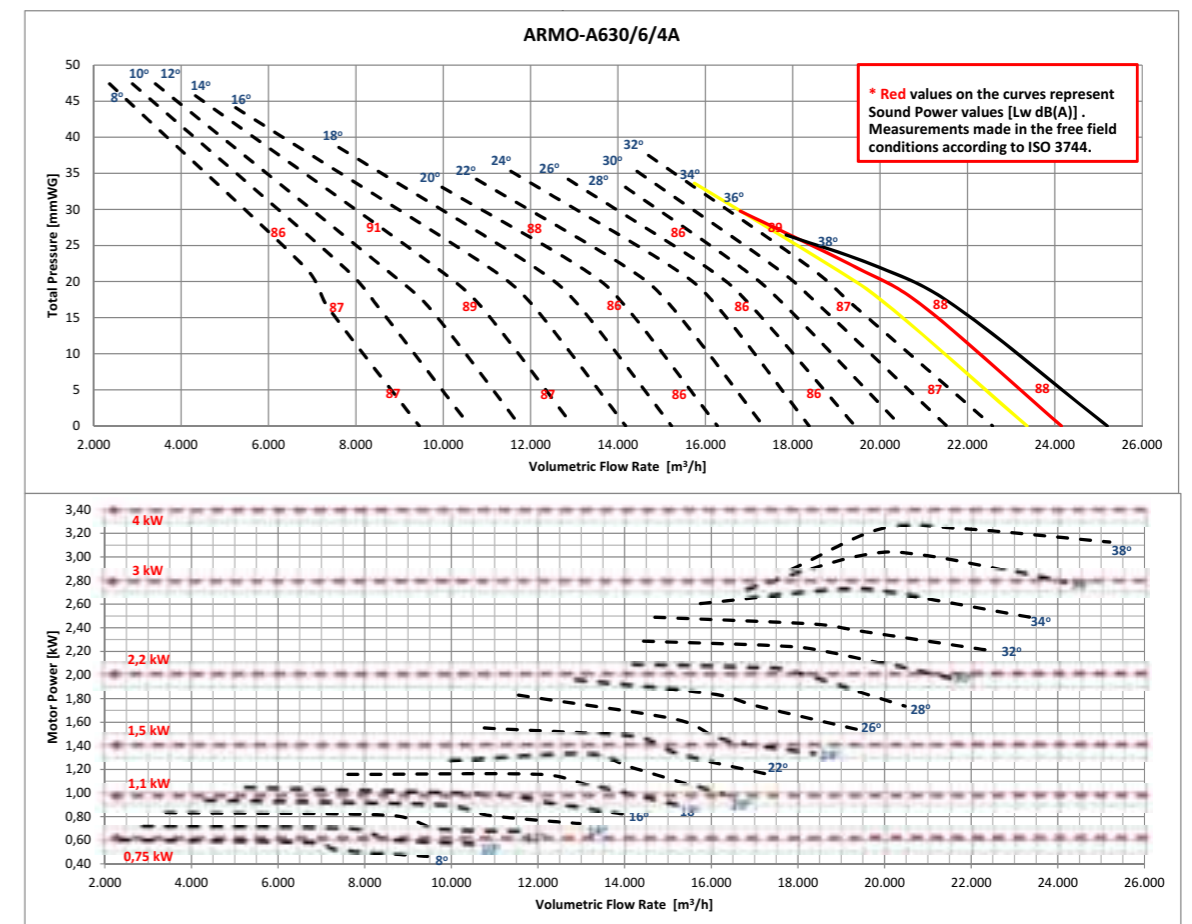
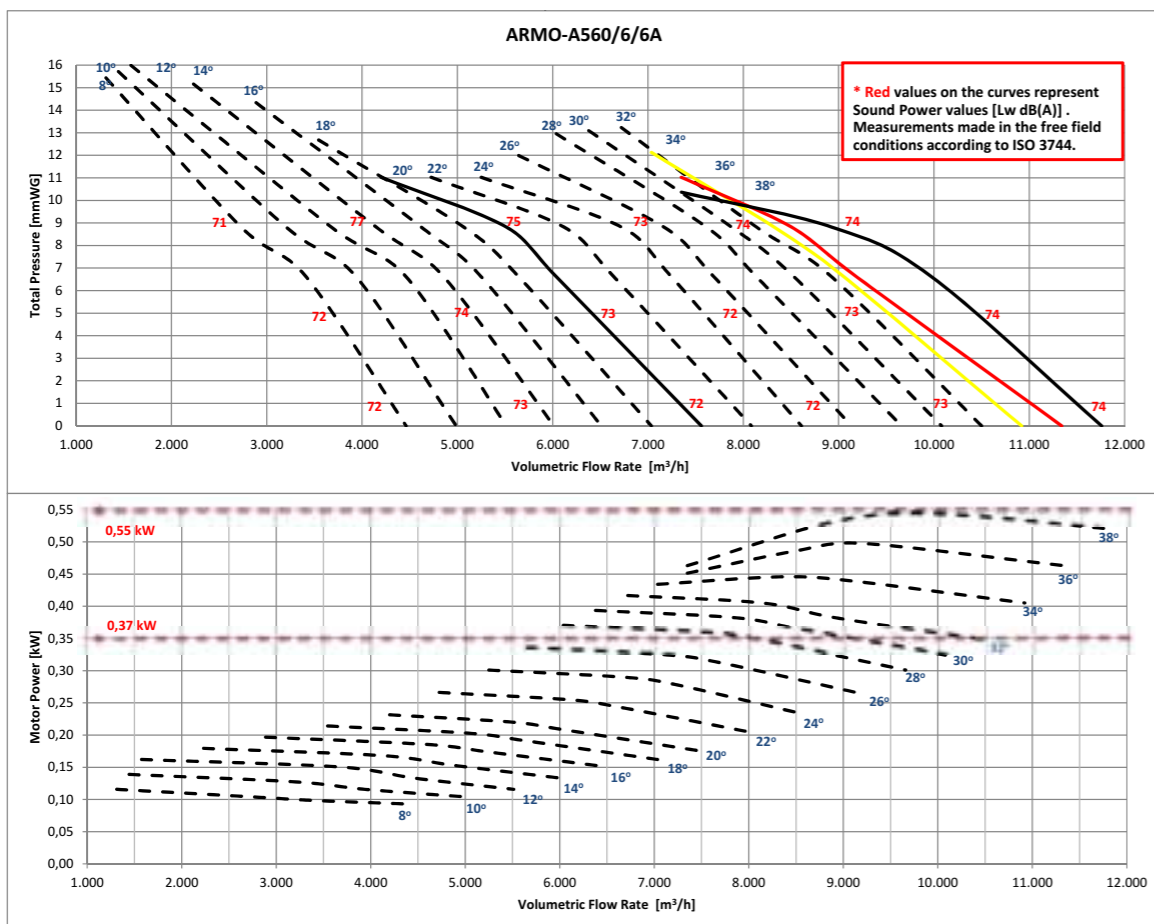
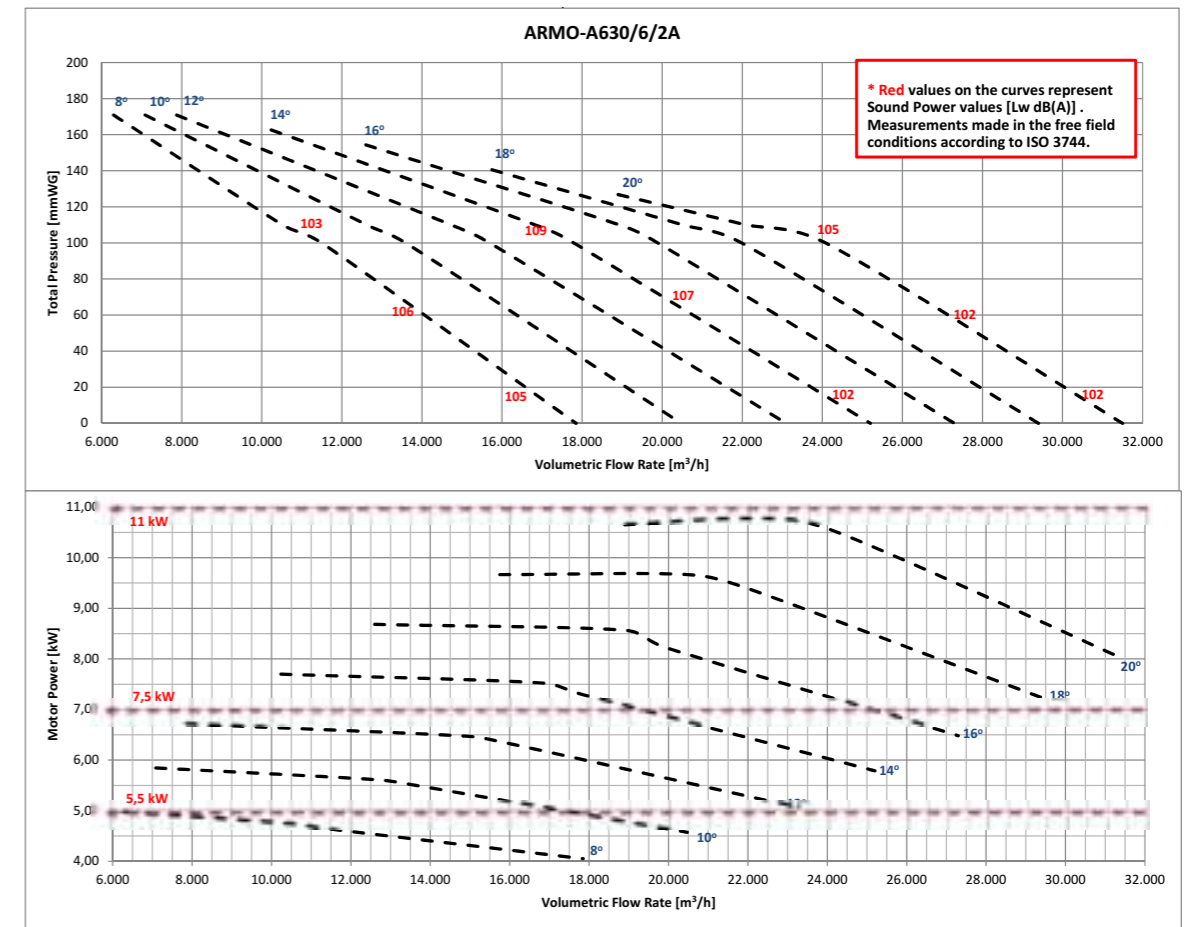
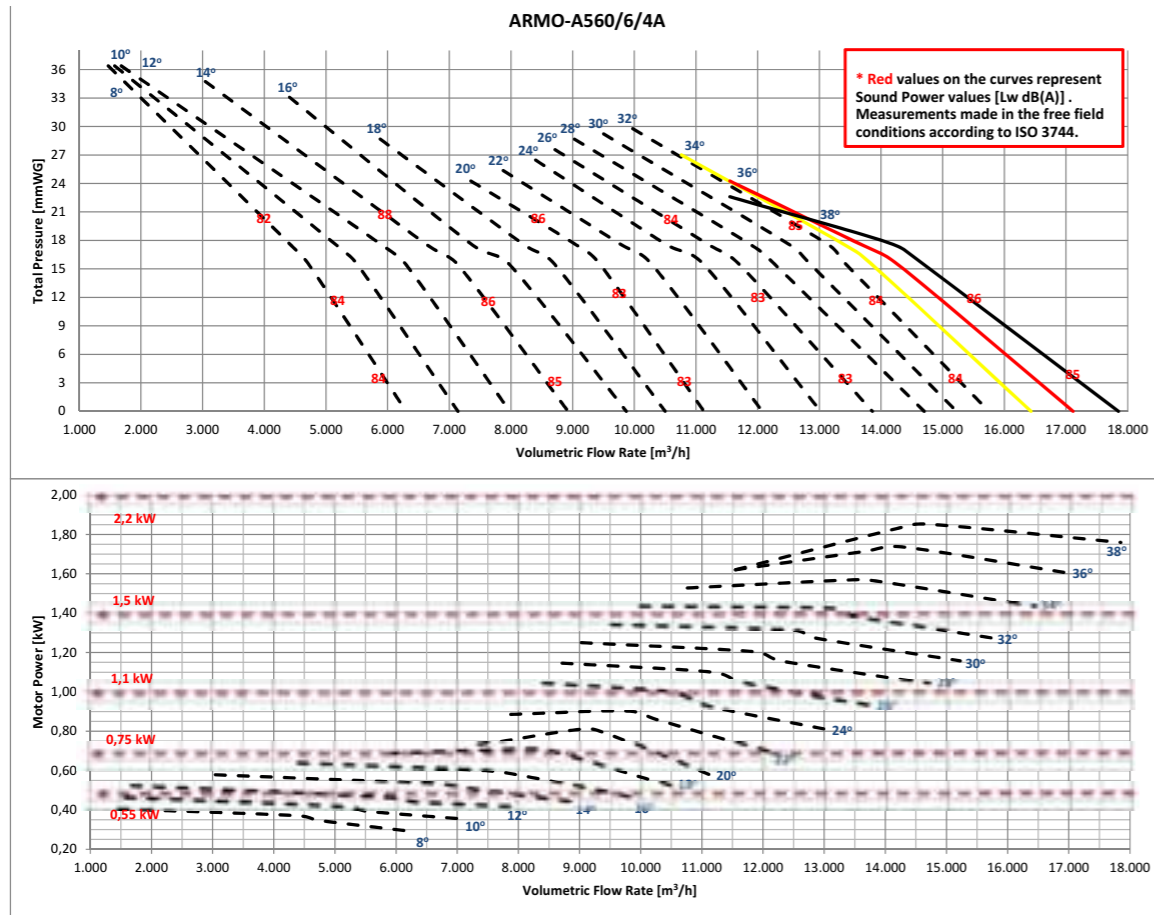

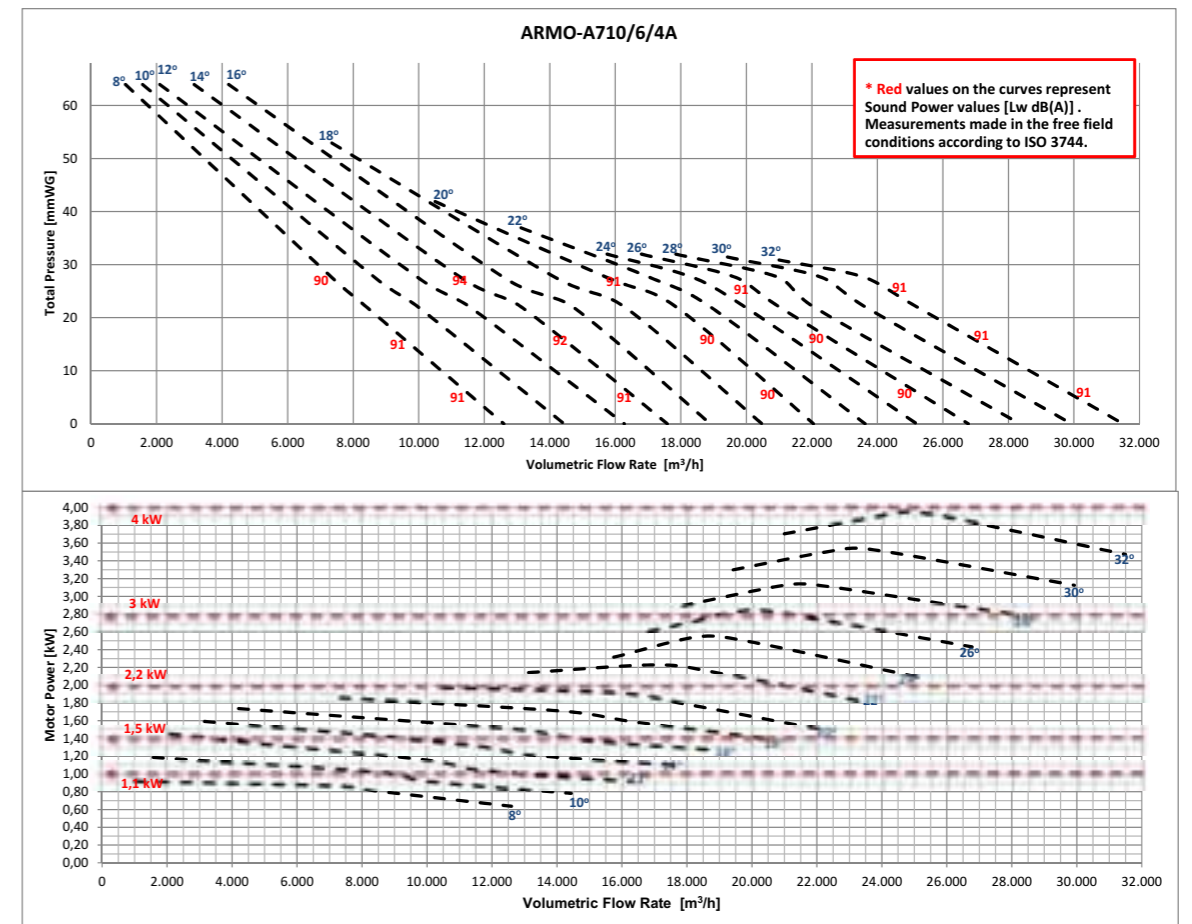
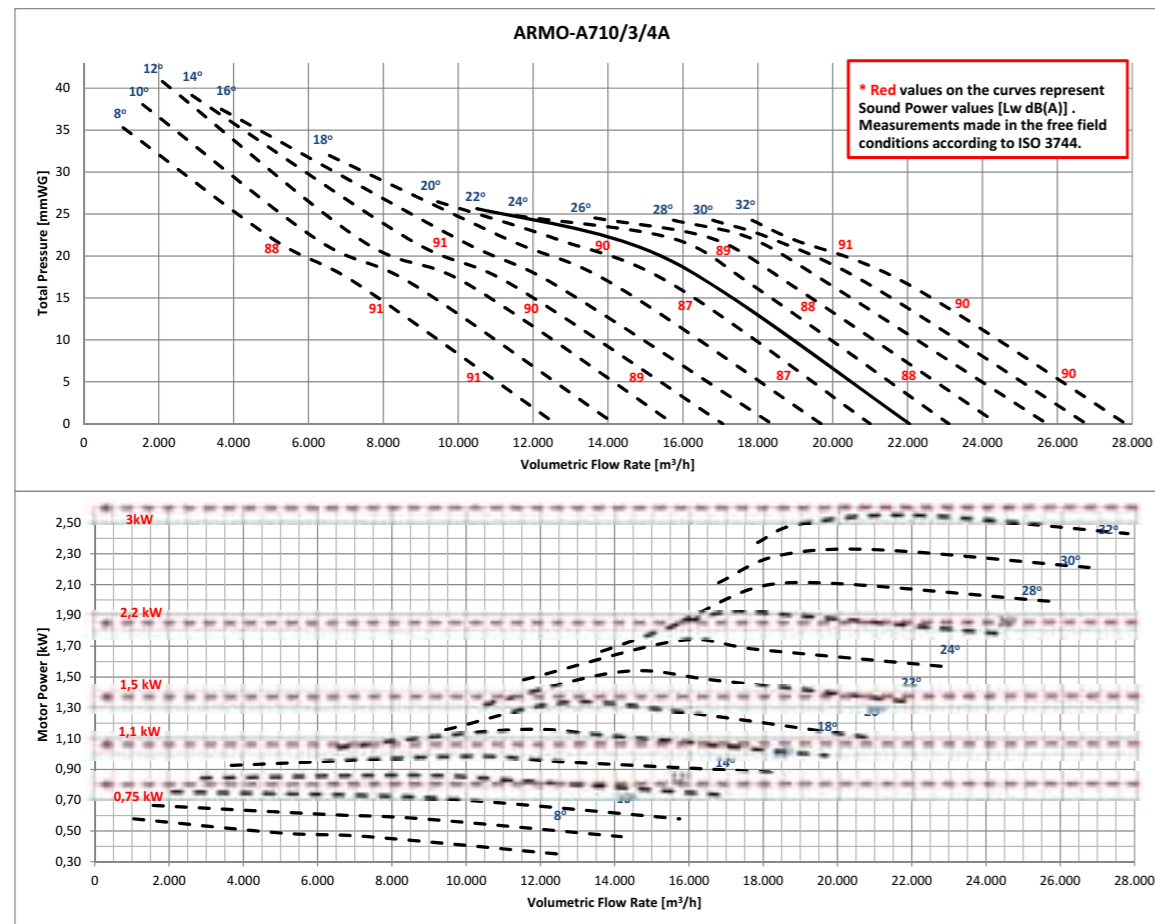
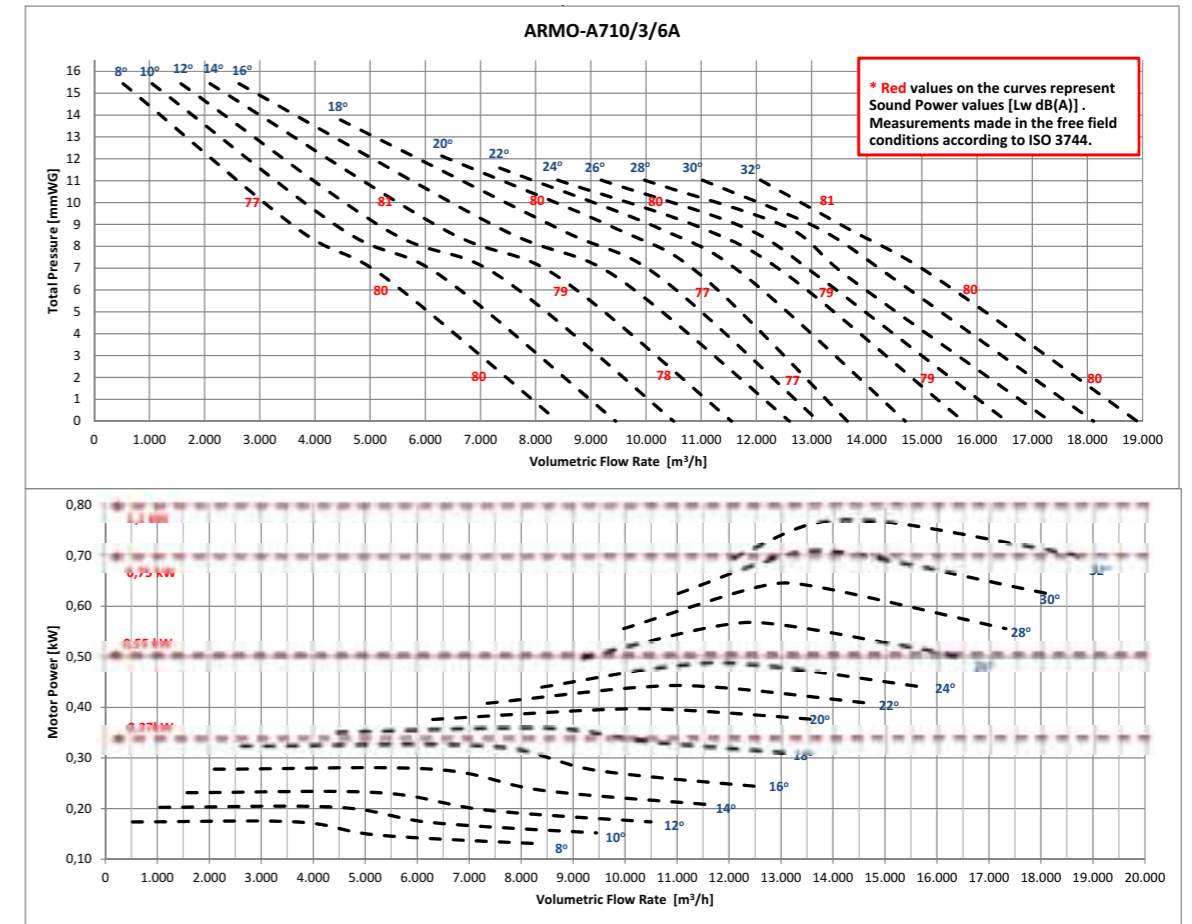
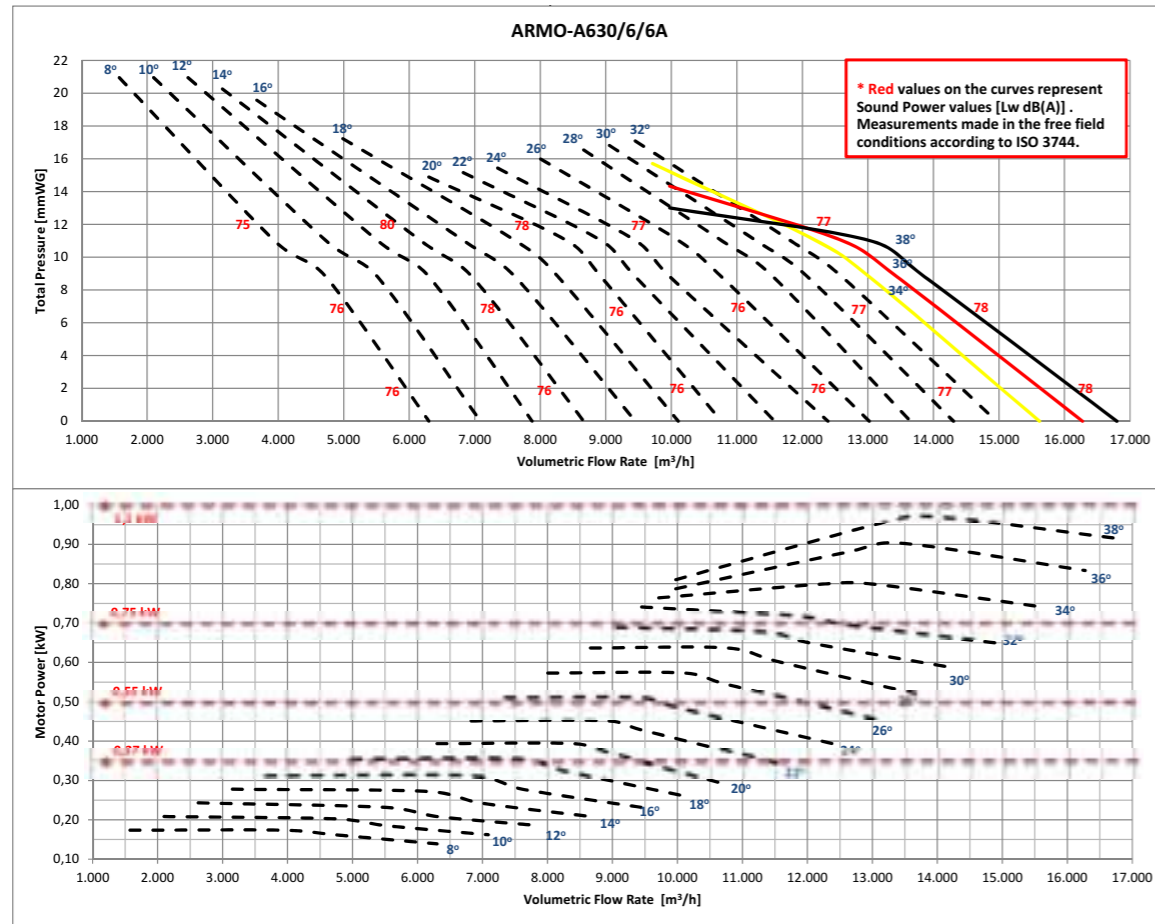

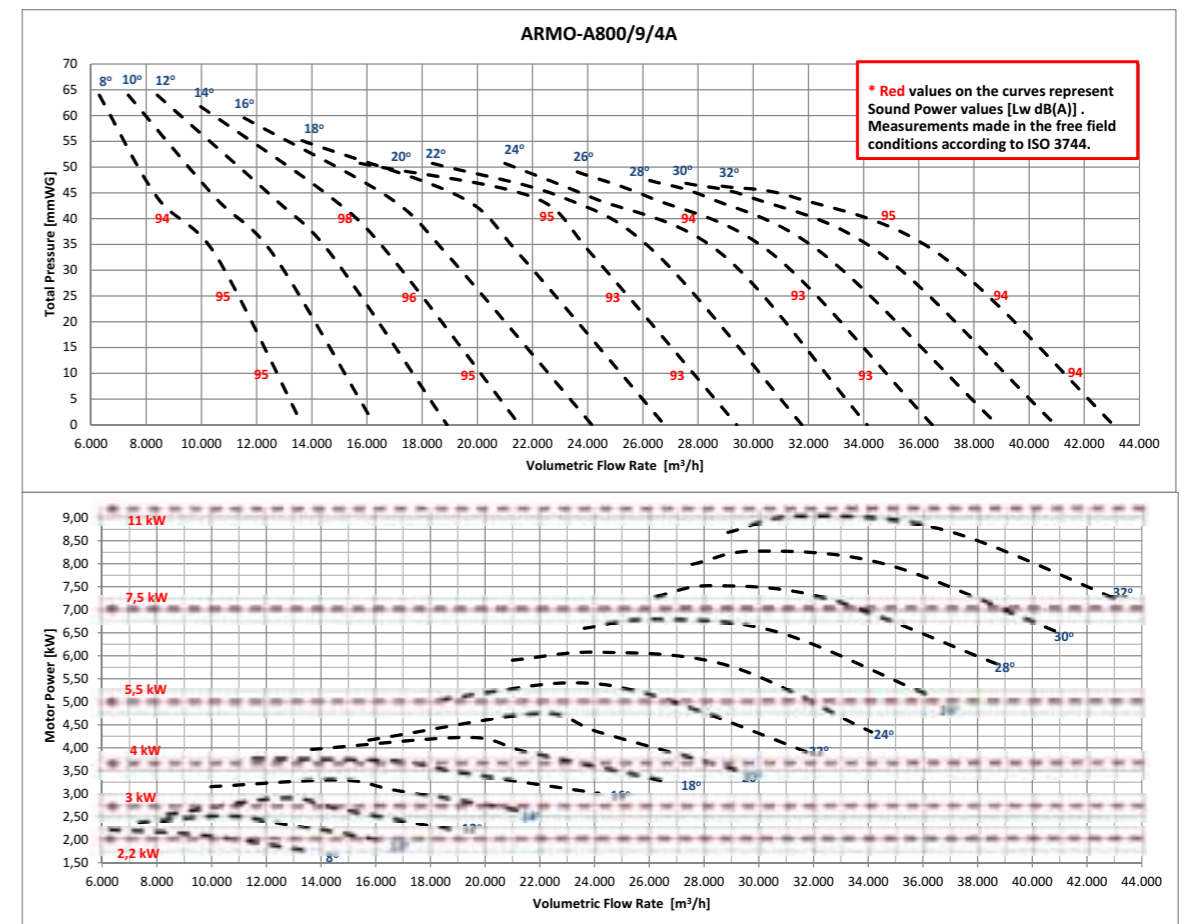
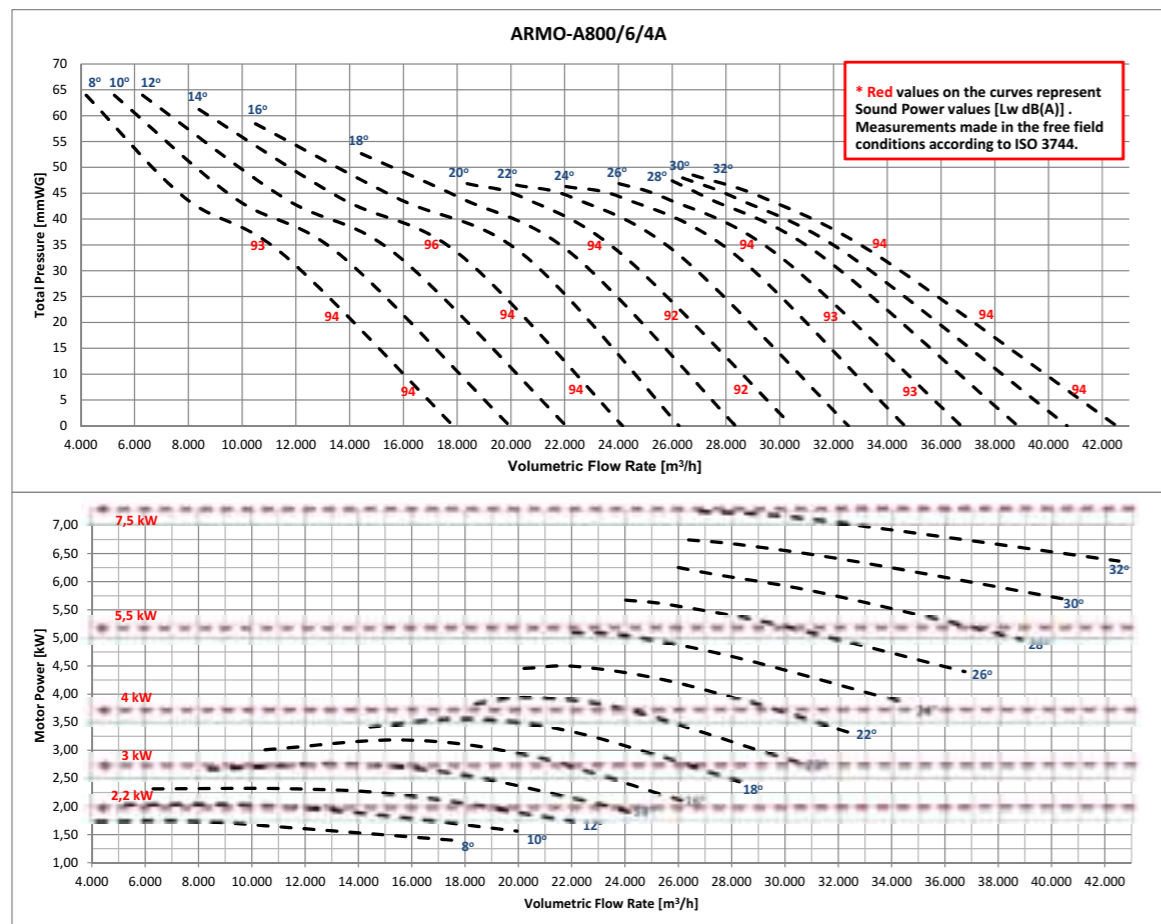
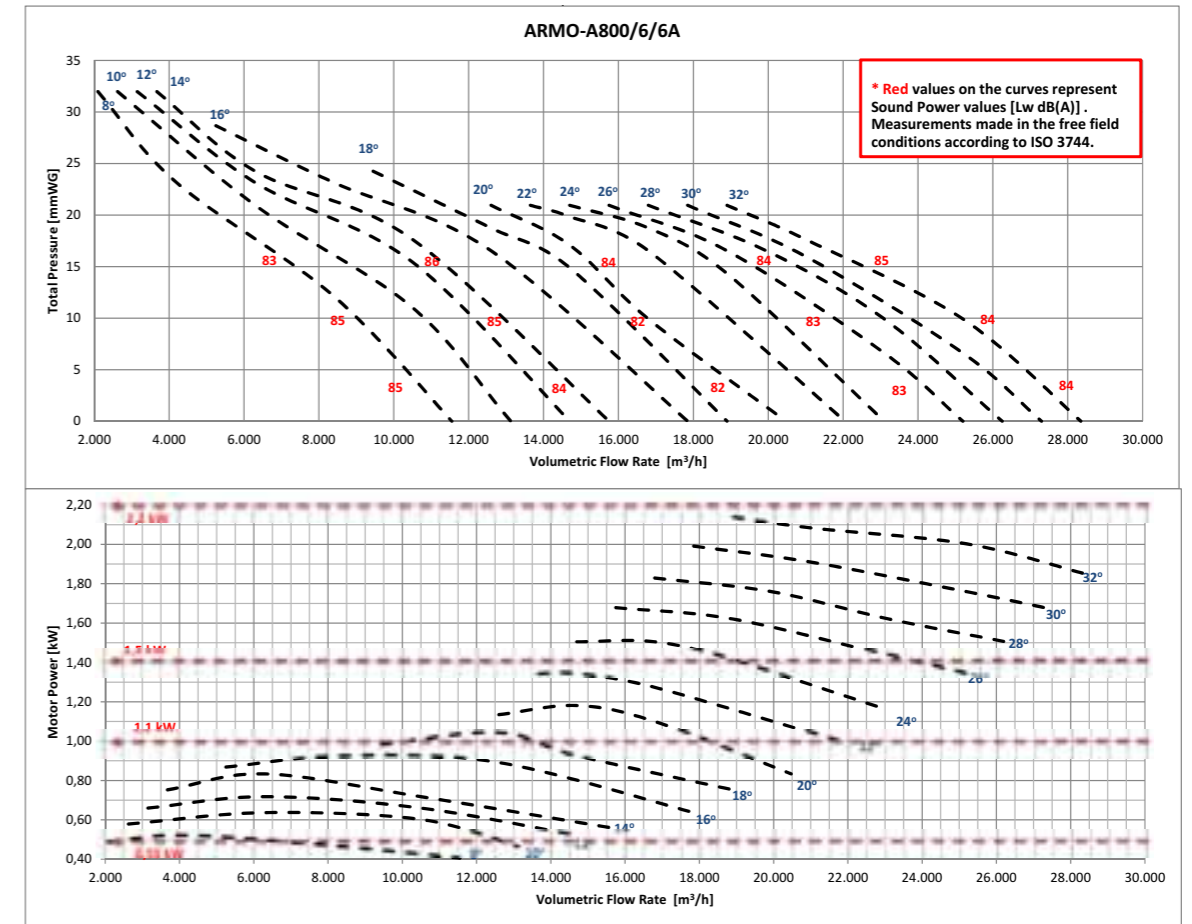
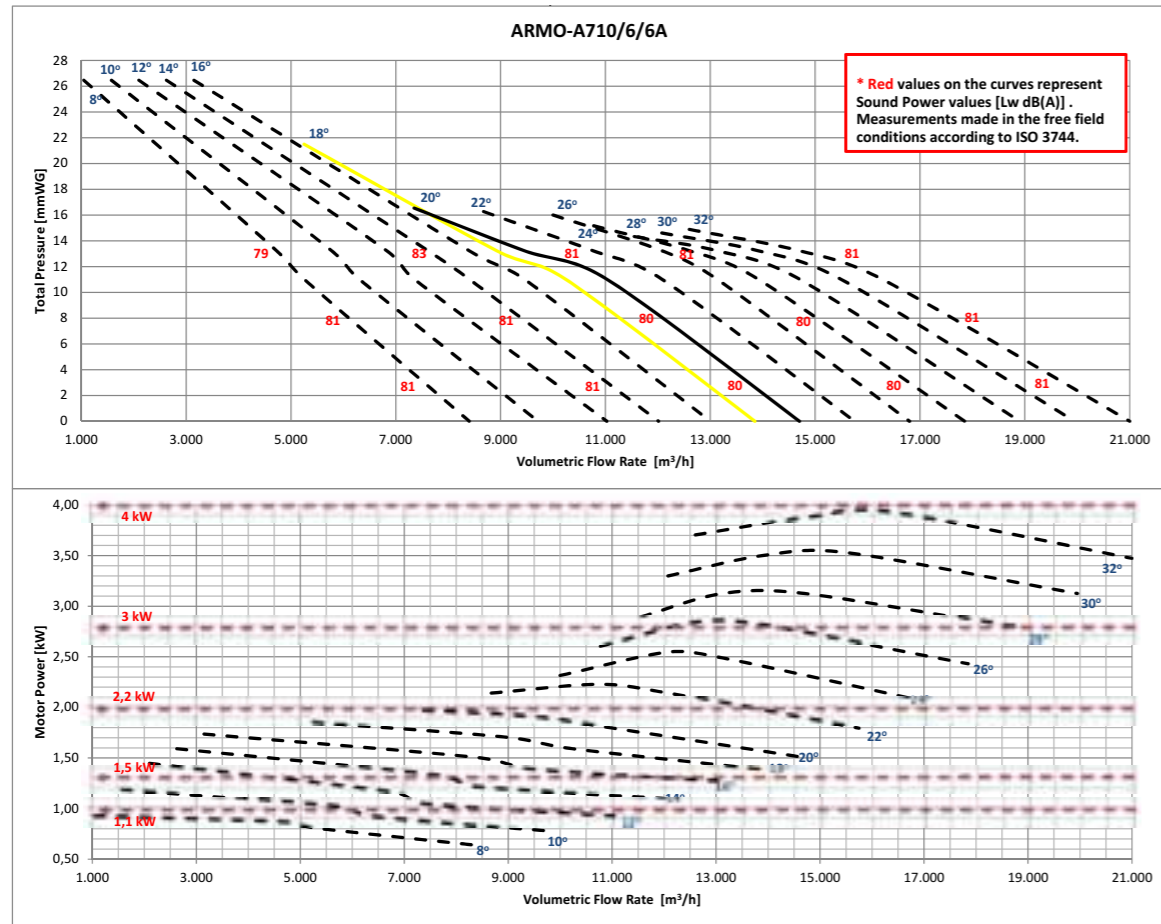

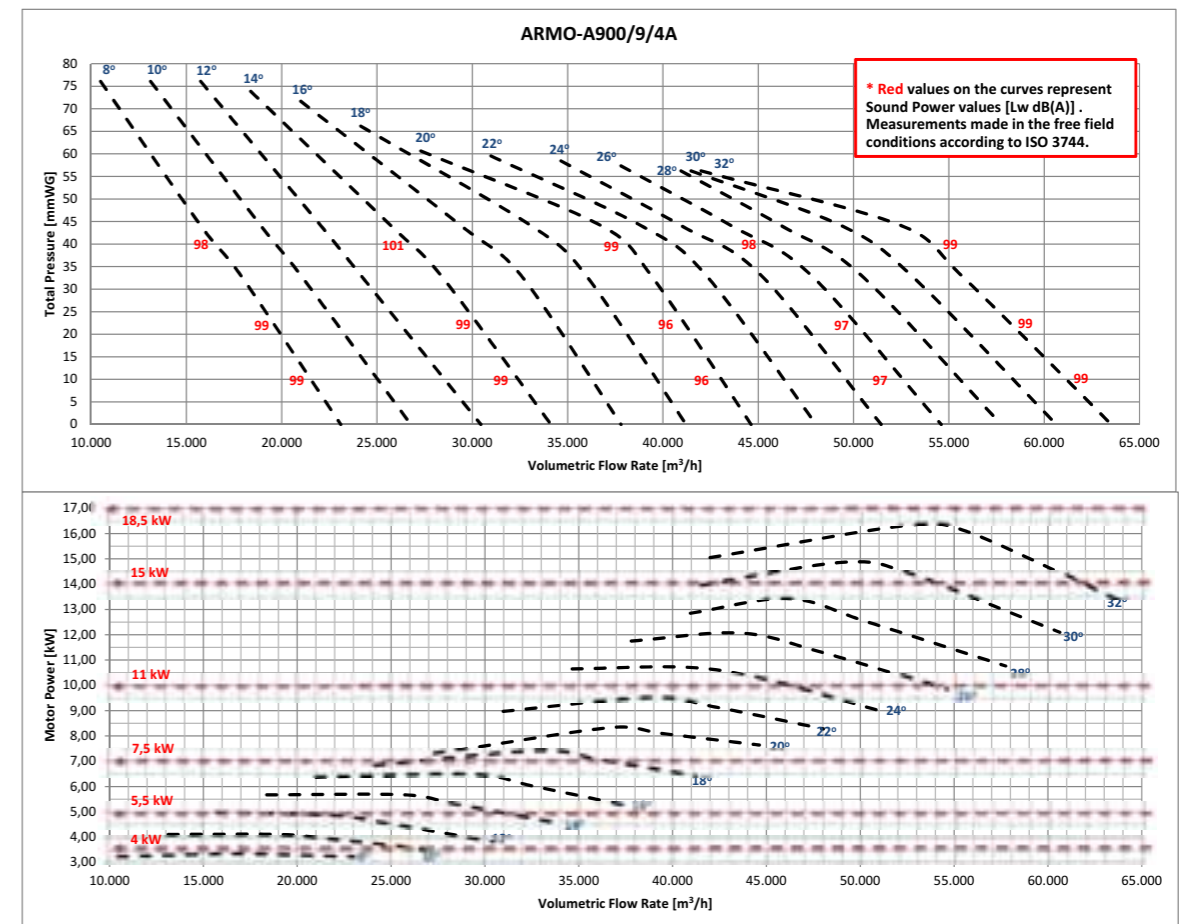
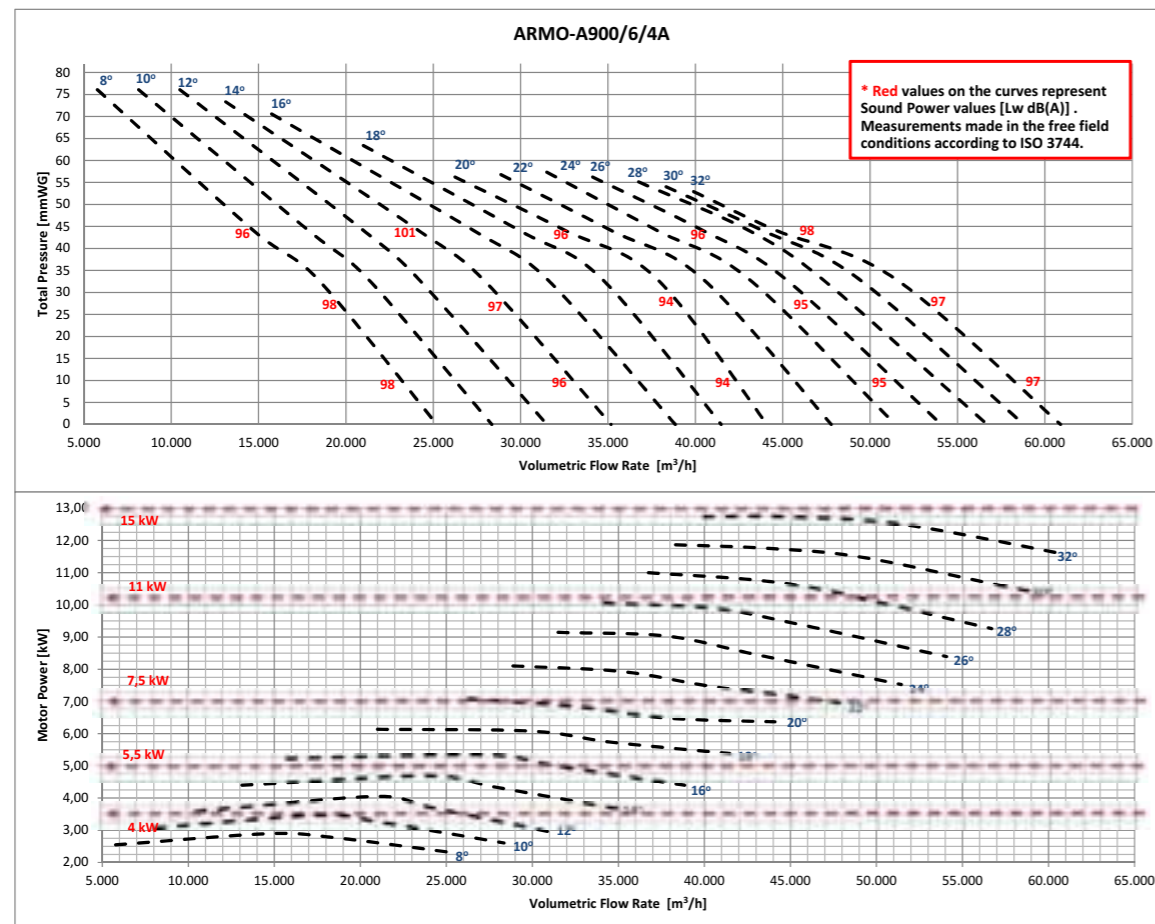
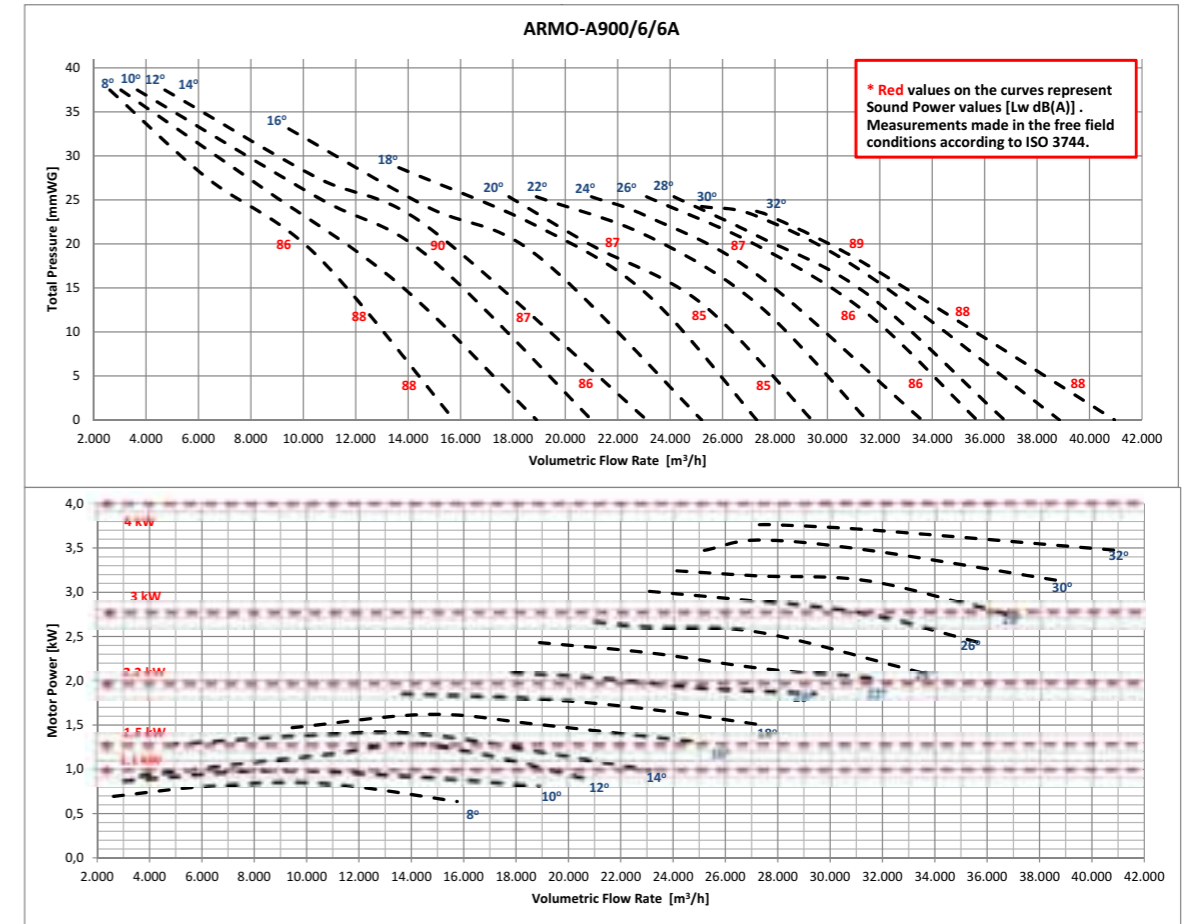
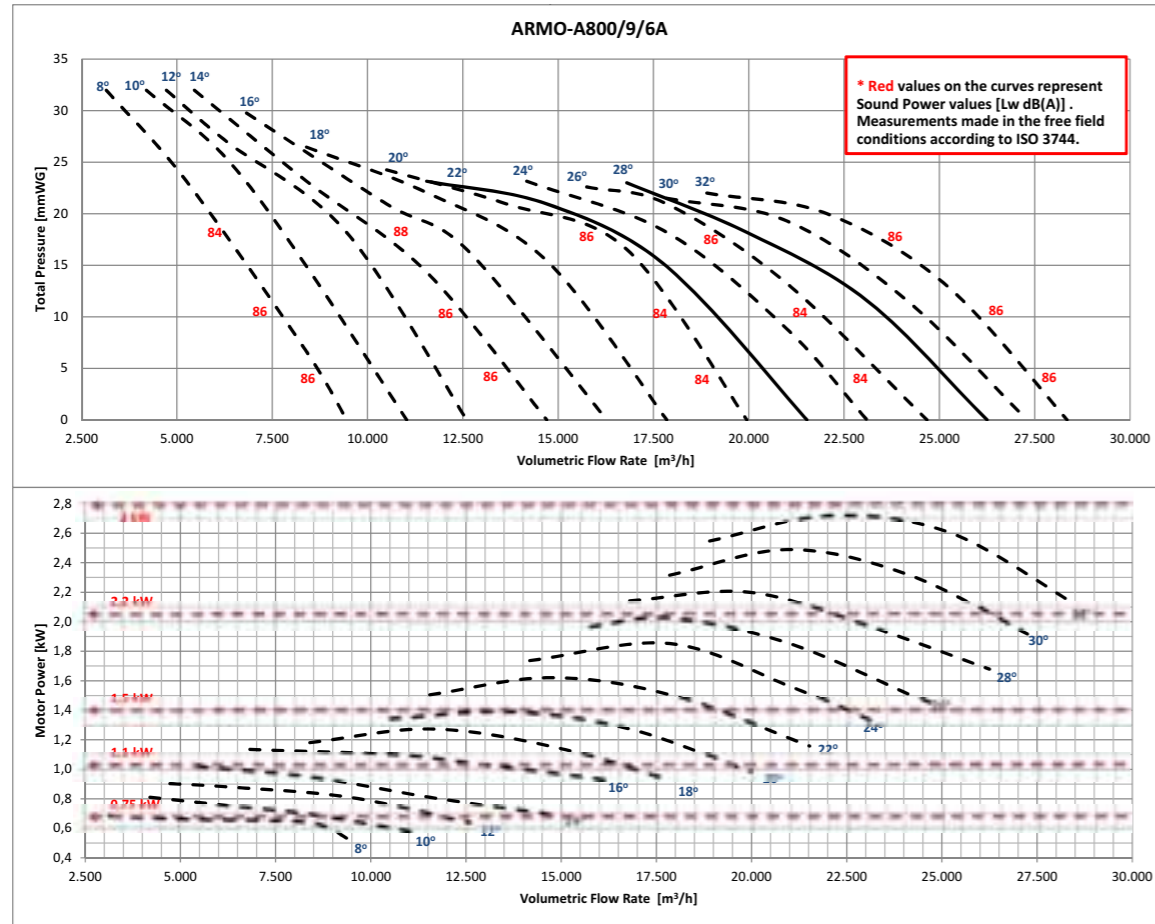

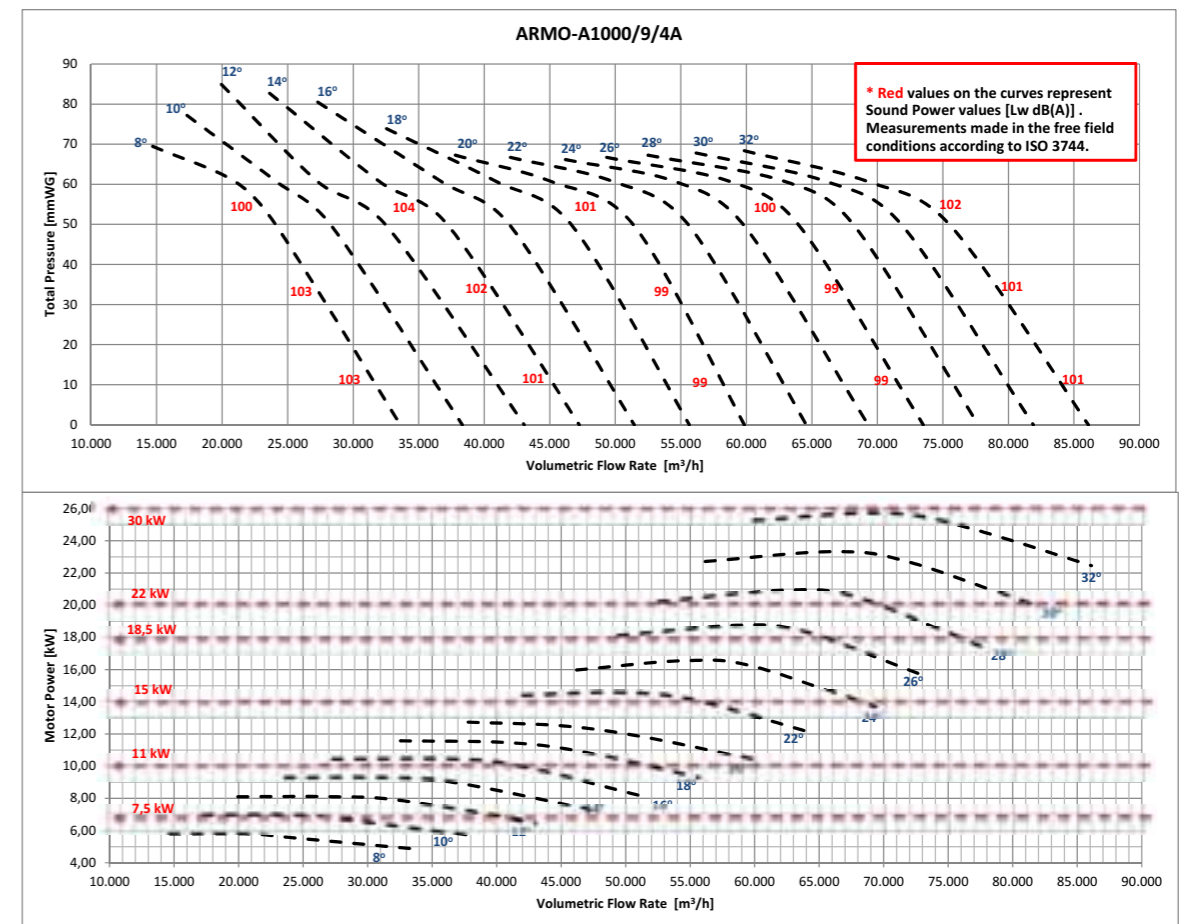
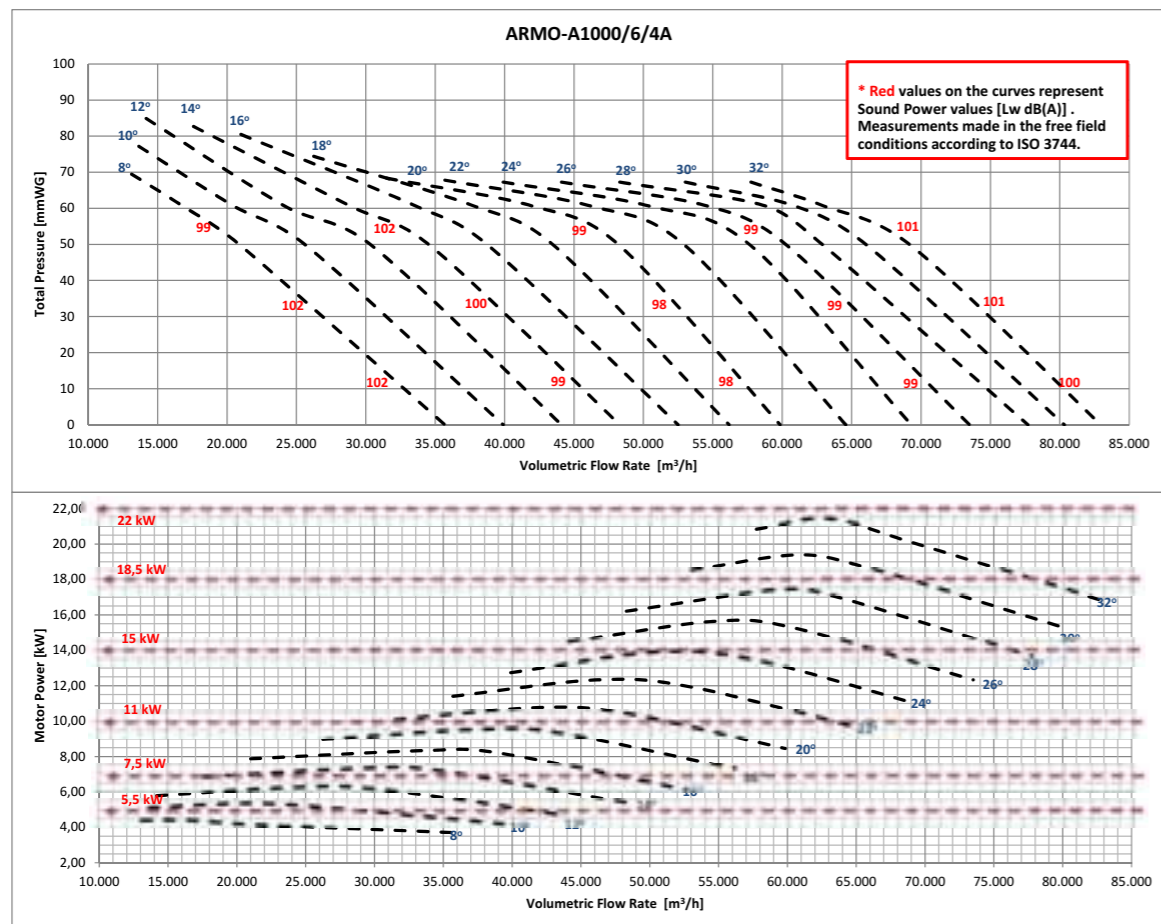
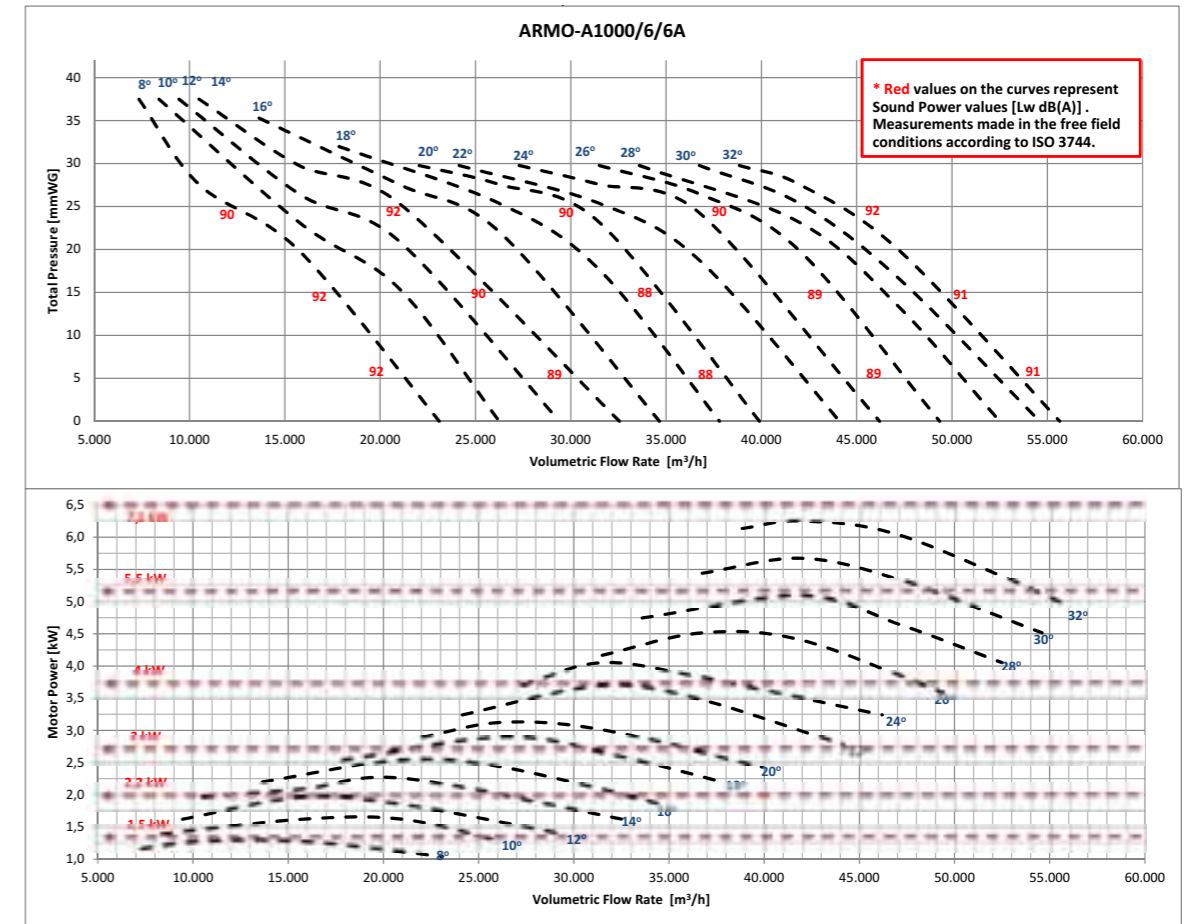
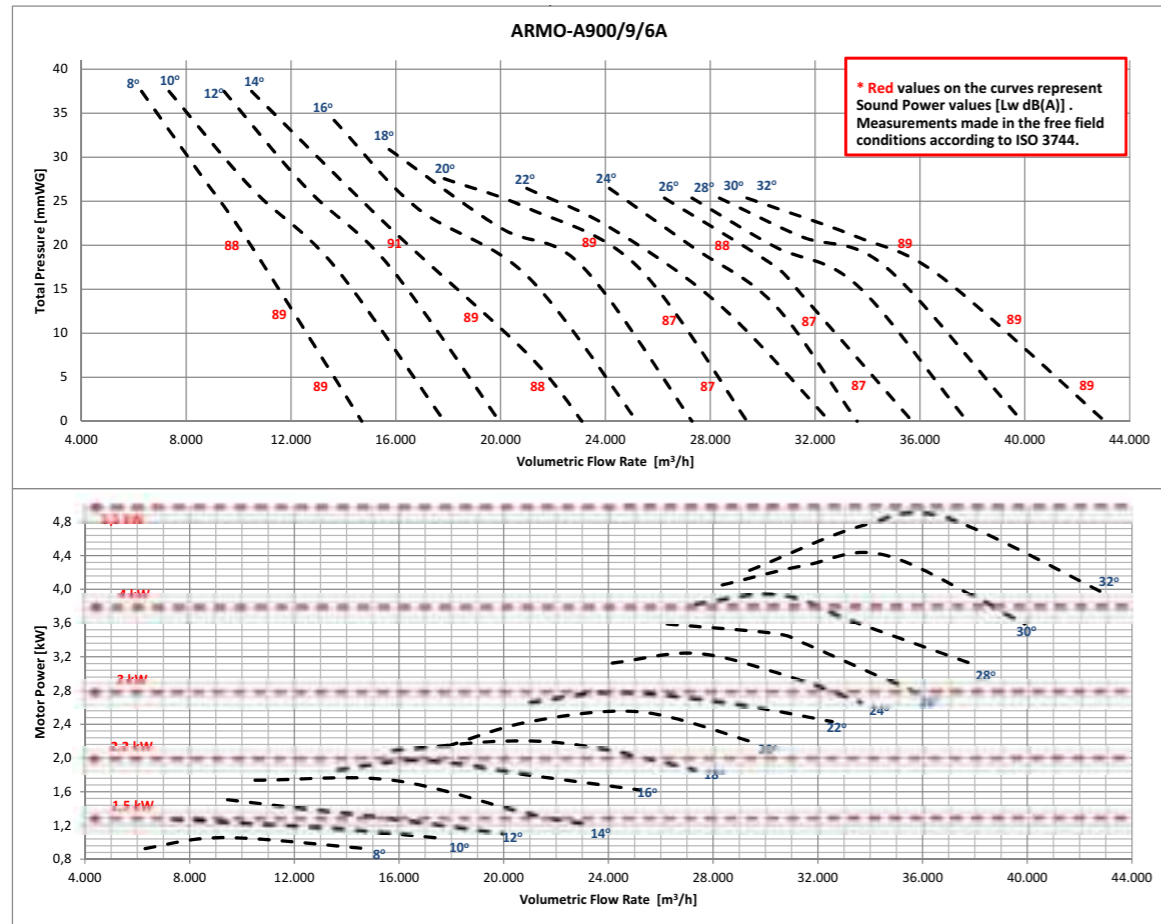

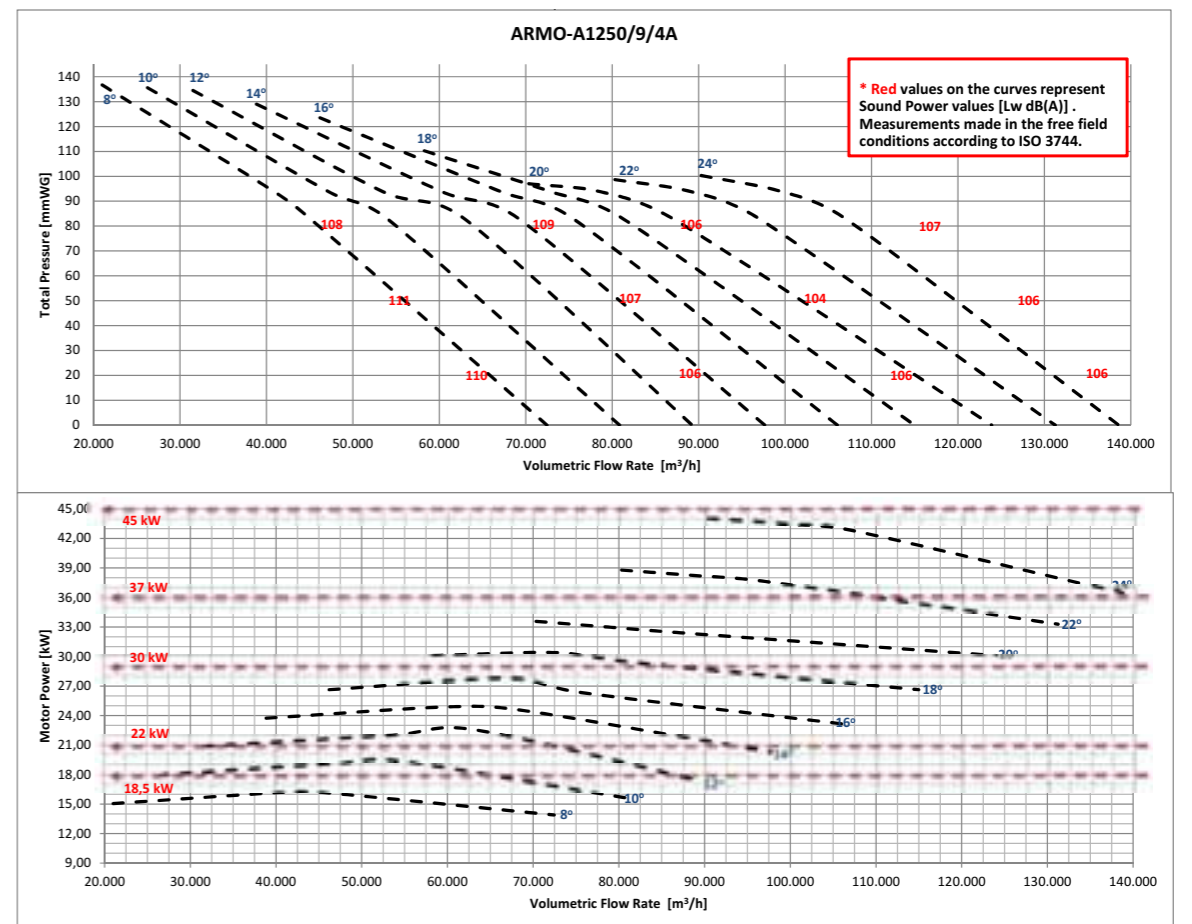
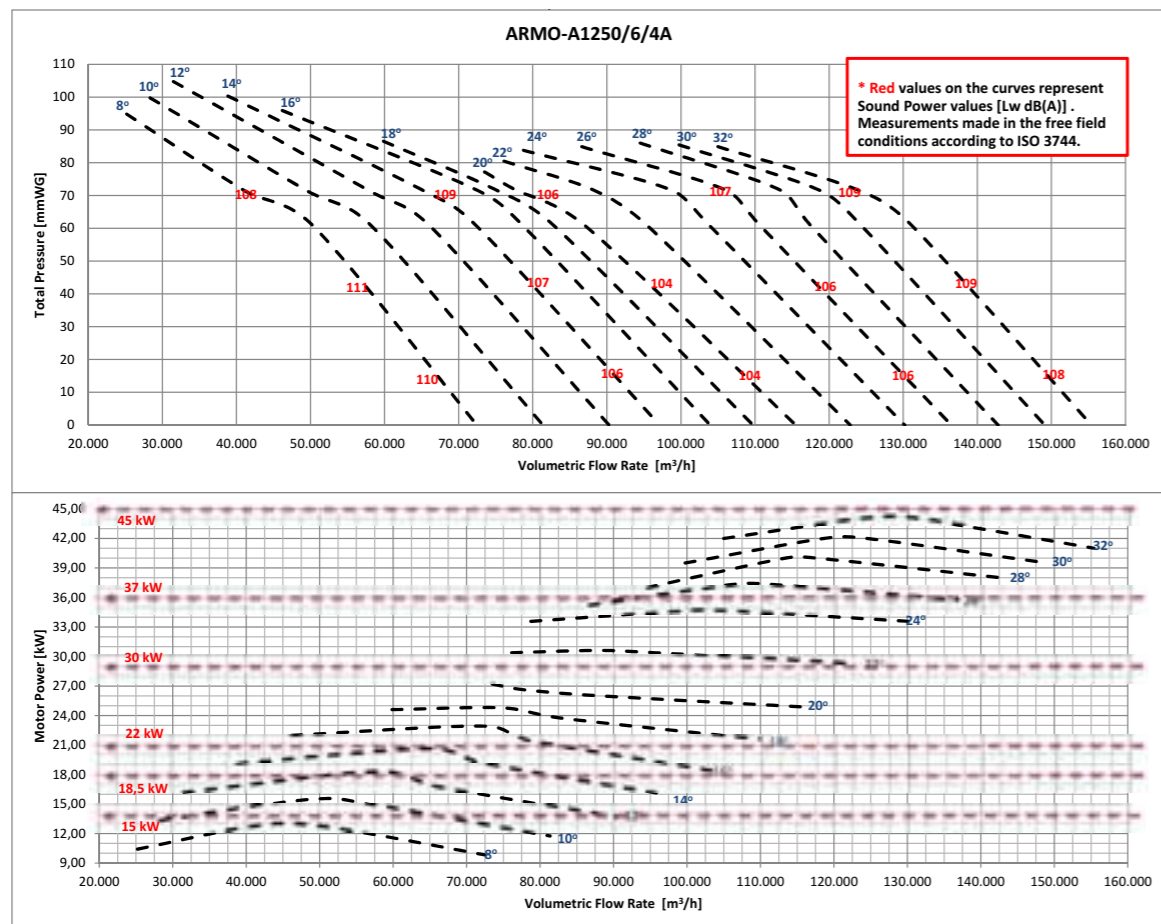
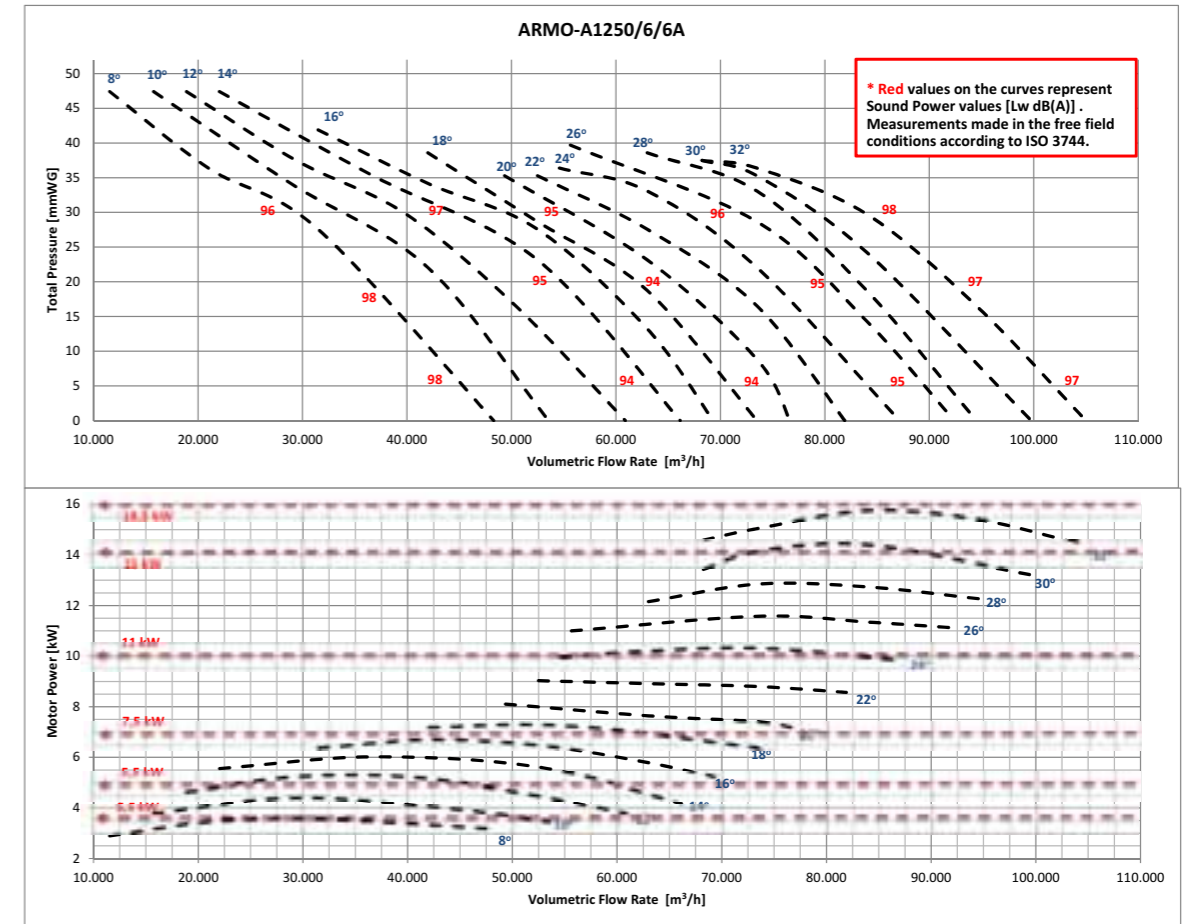
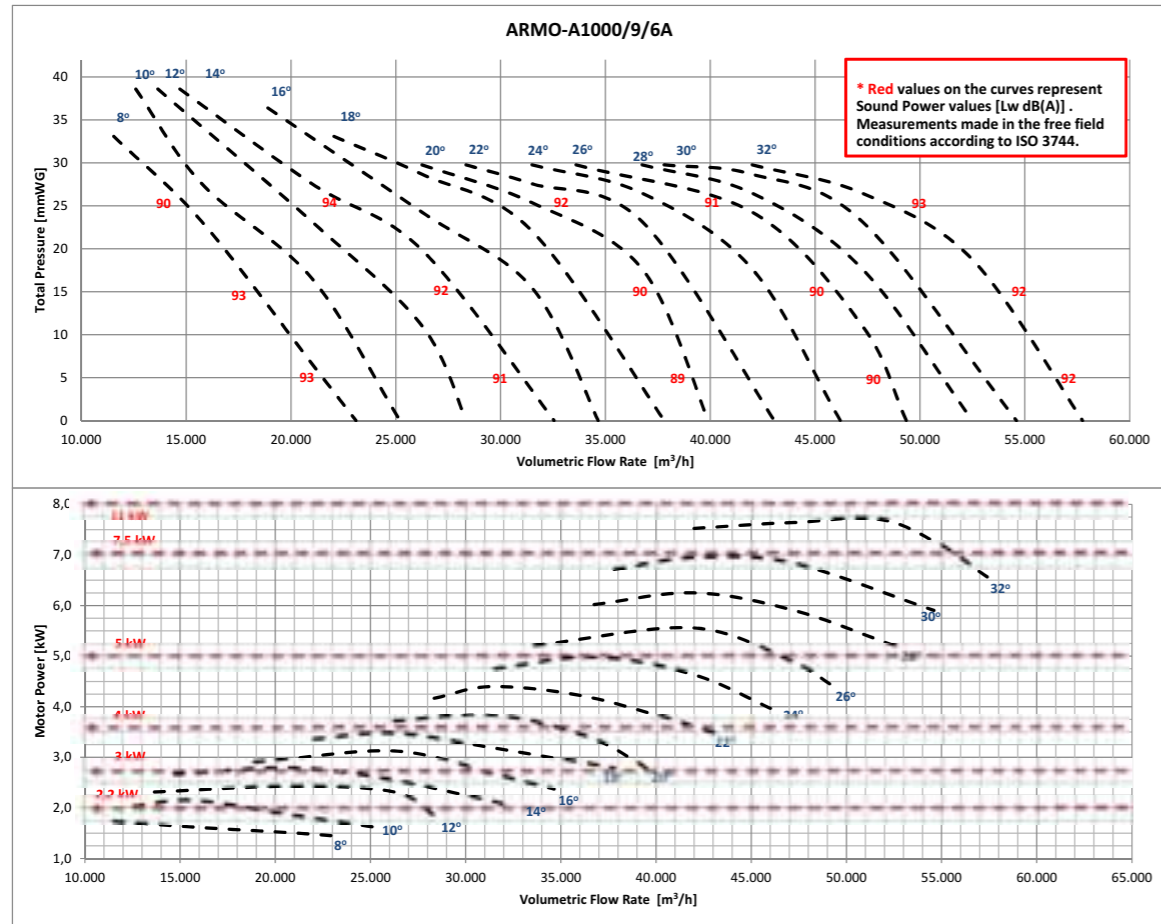

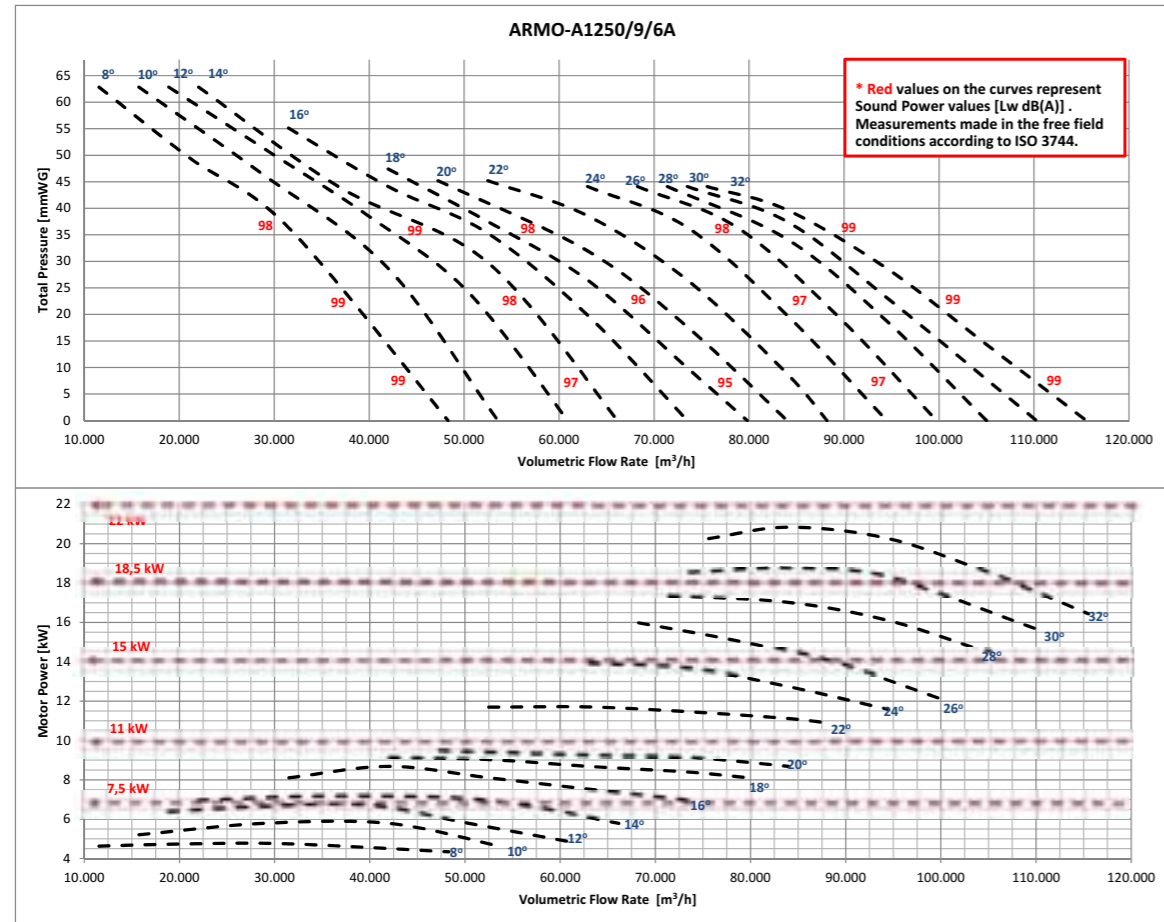

ARMO-C

PRESSURATION FANS / Cabinet

Box Axial fans are used in pressurization fan, fresh air fan and smoke exhaust fan applications. The box is fire resistant and designed according to the noise standard. Smoke evacuation fans are fire resistant.

General Features

- It has EN 12101-3 and Ce certificates.
- 2 hours continuous operation at 400 C and 300C
- There is a wide product range from 400 mm to 1250 mm.

Rotor Features

- Fire resistant aluminum alloy casting blades and fan hub.
- has the ability to work one-way and two-way. The blades are specially designed according to each direction type.
- There is no aerodynamic loss in the case of reversible wing type operation.
- Wings are airfoil and provide high aerodynamic performance in both unidirectional and bidirectional vanes.
- Wing angles are adjustable. In this way, smoke discharge fans can be demanded at different flow rates and pressures.

- The fan part of the fan is dynamically balanced according to ISO 1940 and there is no eccentricity during the operation of the fan.

Body Features

- Fan body is steel sheet. Body is hot dip galvanized and corrosion resistant.
- It has short type body and long type body types.

Motor Features

- Offers 2.4 and 6-pole motors
- The motors are IP 55 class and Class-H insulated.
- All electric motor models are approved for continuous operation (S1) and Emergency operation (S2).

Ease of Maintenance

A maintenance cover is provided to ensure easy maintenance.

Usage Areas

Stair pressurization fan, fresh air fan, smoke is used as exhaust fan.

Technical Drawing and Tables

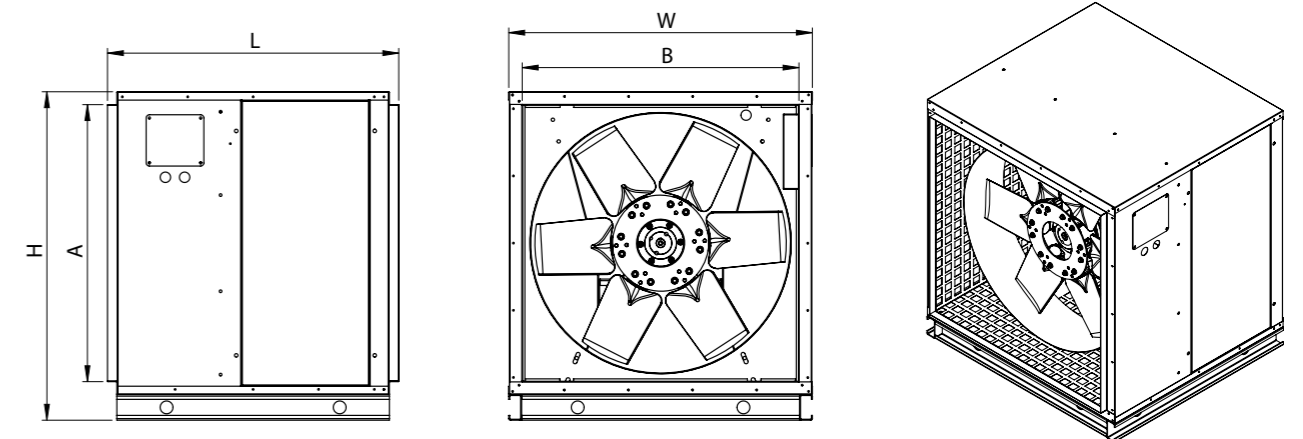

TYPE	L	W	H	A	B
ARMO-C 400	592	568	640	490	490
ARMO-C 450	592	568	640	490	490
ARMO-C 500	592	620	686	536	536
ARMO-C 560	745	707	775	624	624
ARMO-C 630	745	777	845	694	694
ARMO-C 710	910	857	925	774	774
ARMO-C 800	910	950	1025	865	865
ARMO-C 900	1065	1050	1125	965	965
ARMO-C 1000	1065	1150	1250	1069	1069
ARMO-C 1250	1065	1400	1500	1319	1319

Dimensions are in (mm)



2 POLE						
TYPE	SPEED	DIAMETER	POWER	CURRENT	AIR FLOW	WING ANGLE
	r.p.m	mm	kW	230V - 400V	m³/h	
ARMO-C / 400-6 / 0,75 - 2A	2900	400	0,75	1,6	5250	16°
ARMO-C / 400-6 / 1,1 - 2A	2900	400	1,1	2,3	6904	22°
ARMO-C / 400-6 / 1,5 - 2A	2900	400	1,5	3,4	8978	30°
ARMO-C / 400-6 / 2,2 - 2A	2900	400	2,2	4,48	9975	34°
ARMO-C / 450-6 / 1,1 - 2A	2900	450	1,1	2,3	6248	10°
ARMO-C / 450-6 / 1,5 - 2A	2900	450	1,5	3,4	8610	16°
ARMO-C / 450-6 / 2,2 - 2A	2900	450	2,2	4,48	11970	24°
ARMO-C / 450-6 / 3 - 2A	2900	450	3	6	13545	28°
ARMO-C / 500-6 / 2,2 - 2A	2900	500	2,2	4,48	11000	14°
ARMO-C / 500-6 / 3 - 2A	2900	500	3	6	14595	20°
ARMO-C / 500-6 / 4 - 2A	2900	500	4	7,4	17325	26°
ARMO-C / 500-6 / 5,5 - 2A	2900	500	5,5	11	18375	28°
ARMO-C / 560-6 / 4 - 2A	2900	560	4	7,4	17850	14°
ARMO-C / 560-6 / 5,5 - 2A	2900	560	5,5	11	22313	20°
ARMO-C / 560-6 / 7,5 - 2A	2800	560	7,5	13,6	25725	24°
ARMO-C / 630-6 / 5,5 - 2A	2900	630	5,5	11	20475	10°
ARMO-C / 630-6 / 7,5 - 2A	2800	630	7,5	13,6	27300	16°

4 POLE						
TYPE	SPEED	DIAMETER	POWER	CURRENT	AIR FLOW	WING ANGLE
	r.p.m	mm	kW	230V - 400V	m³/h	
ARMO-C / 500-6 / 0,55 - 4A	1415	500	0,55	1,6	8715	26
ARMO-C / 500-6 / 0,75 - 4A	1350	500	0,75	2,1	10290	32
ARMO-C / 500-6 / 1,1 - 4A	1400	500	1,1	2,6	12600	38
ARMO-C / 560-6 / 0,55 - 4A	1415	560	0,55	1,6	9870	16
ARMO-C / 560-6 / 0,75 - 4A	1350	560	0,75	2,1	12075	22
ARMO-C / 560-6 / 1,1 - 4A	1400	560	1,1	2,6	13860	26
ARMO-C / 560-6 / 1,5 - 4A	1405	560	1,5	3,5	15750	32
ARMO-C / 560-6 / 2,2 - 4A	1410	560	2,2	5	17850	38
ARMO-C / 630-6 / 0,75 - 4A	1350	630	0,75	2,1	10605	10
ARMO-C / 630-6 / 1,1 - 4A	1400	630	1,1	2,6	16275	20
ARMO-C / 630-6 / 1,5 - 4A	1405	630	1,5	3,5	18375	24
ARMO-C / 630-6 / 2,2 - 4A	1410	630	2,2	5	21525	30
ARMO-C / 630-6 / 3 - 4A	1410	630	3	6,6	24150	36
ARMO-C / 630-6 / 4 - 4A	1500	630	4	8,2	25200	38
ARMO-C / 710-3 / 0,75 - 4A	1350	710	0,75	2,1	14175	10
ARMO-C / 710-3 / 1,1 - 4A	1400	710	1,1	2,6	18375	16
ARMO-C / 710-3 / 1,5 - 4A	1405	710	1,5	3,5	21000	20
ARMO-C / 710-3 / 2,2 - 4A	1410	710	2,2	5	24413	26
ARMO-C / 710-3 / 3 - 4A	1410	710	3	6,6	27825	32
ARMO-C / 710-6 / 1,1 - 4A	1400	710	1,1	2,6	16275	12
ARMO-C / 710-6 / 1,5 - 4A	1405	710	1,5	3,5	20475	18
ARMO-C / 710-6 / 2,2 - 4A	1410	710	2,2	5	23625	22
ARMO-C / 710-6 / 3 - 4A	1410	710	3	6,6	28350	28
ARMO-C / 710-6 / 4 - 4A	1415	710	4	8,2	31500	32
ARMO-C / 800-6 / 2,2 - 4A	1410	800	2,2	5	24150	14
ARMO-C / 800-6 / 3 - 4A	1410	800	3	6,6	30450	20
ARMO-C / 800-6 / 4 - 4A	1415	800	4	8,2	32550	22
ARMO-C / 800-6 / 5,5 - 4A	1430	800	5,5	11,2	38850	28
ARMO-C / 800-6 / 7,5 - 4A	1440	800	7,5	15,4	42525	32
ARMO-C / 800-9 / 2,2 - 4A	1410	800	2,2	5	16275	10
ARMO-C / 800-9 / 3 - 4A	1410	800	3	6,6	21525	14
ARMO-C / 800-9 / 4 - 4A	1415	800	4	8,2	29400	20
ARMO-C / 800-9 / 5,5 - 4A	1430	800	5,5	11,2	36488	26
ARMO-C / 800-9 / 7,5 - 4A	1440	800	7,5	15,4	40950	30
ARMO-C / 800-9 / 11 - 4A	1450	800	11	21	43050	32
ARMO-C / 900-6 / 4 - 4A	1415	900	4	8,2	31500	12
ARMO-C / 900-6 / 5,5 - 4A	1430	900	5,5	11,2	38850	16
ARMO-C / 900-6 / 7,5 - 4A	1440	900	7,5	15,4	47775	22
ARMO-C / 900-6 / 11 - 4A	1450	900	11	21	56700	28
ARMO-C / 900-6 / 15 - 4A	1450	900	15	29,3	60900	32
ARMO-C / 900-9 / 4 - 4A	1415	900	4	8,2	26775	10
ARMO-C / 900-9 / 5,5 - 4A	1430	900	5,5	11,2	34125	14
ARMO-C / 900-9 / 7,5 - 4A	1440	900	7,5	15,4	41213	18
ARMO-C / 900-9 / 11 - 4A	1450	900	11	21	54600	26
ARMO-C / 900-9 / 15 - 4A	1450	900	15	29,3	63525	32
ARMO-C / 1000-6 / 5,5 - 4A	1430	1000	5,5	11,2	38850	12
ARMO-C / 1000-6 / 7,5 - 4A	1440	1000	7,5	15,4	47775	18
ARMO-C / 1000-6 / 11 - 4A	1450	1000	11	21	56700	22
ARMO-C / 1000-6 / 15 - 4A	1450	1000	15	29,3	60900	28
ARMO-C / 1000-6 / 18,5 - 4A	1455	1000	18,5	34,5	56700	32
ARMO-C / 1000-9 / 7,5 - 4A	1440	1000	7,5	15,4	43050	12
ARMO-C / 1000-9 / 11 - 4A	1450	1000	11	21	55650	18
ARMO-C / 1000-9 / 15 - 4A	1450	1000	15	29,3	69300	24
ARMO-C / 1000-9 / 18,5 - 4A	1455	1000	18,5	34,5	77700	28
ARMO-C / 1000-9 / 22 - 4A	1460	1000	22	42,5	81900	30
ARMO-C / 1000-9 / 30 - 4A	1460	1000	30	55	86100	32
ARMO-C / 1250-6 / 15 - 4A	1450	1250	15	29,3	90300	12
ARMO-C / 1250-6 / 18,5 - 4A	1455	1250	18,5	34,5	103950	16
ARMO-C / 1250-6 / 22 - 4A	1460	1250	22	42,5	109725	18
ARMO-C / 1250-6 / 30 - 4A	1460	1250	30	55	122850	22
ARMO-C / 1250-6 / 37 - 4A	1470	1250	37	67	136500	26
ARMO-C / 1250-6 / 45 - 4A	1475	1250	45	80	155400	32
ARMO-C / 1250-9 / 18,5 - 4A	1455	1250	18,5	34,5	89250	12
ARMO-C / 1250-9 / 22 - 4A	1460	1250	22	42,5	97650	14
ARMO-C / 1250-9 / 30 - 4A	1460	1250	30	55	114975	18
ARMO-C / 1250-9 / 37 - 4A	1470	1250	37	67	131250	22
ARMO-C / 1250-9 / 45 - 4A	1475	1250	45	80	138600	24

6 POLE		SPEED r.p.m	DIAMETER mm	POWER kW	CURRENT 230V - 400V	AIR FLOW m³/h	WING ANGLE
TYPE							
ARMO-C / 500-6 / 0,37 - 6A	900	500	0,37	1,1	8400	38	
ARMO-C / 560-6 / 0,37 - 6A	900	560	0,37	1,1	10500	32	
ARMO-C / 560-6 / 0,55 - 6A	930	560	0,55	1,5	11760	38	
ARMO-C / 630-6 / 0,37 - 6A	900	630	0,37	1,1	11576	22	
ARMO-C / 630-6 / 0,55 - 6A	930	630	0,55	1,5	13650	28	
ARMO-C / 630-6 / 0,75 - 6A	945	630	0,75	2	14963	32	
ARMO-C / 630-6 / 1,1 - 6A	945	630	1,1	2,9	16800	38	
ARMO-C / 710-3 / 0,37 - 6A	900	710	0,37	1,1	13125	18	
ARMO-C / 710-3 / 0,55 - 6A	930	710	0,55	1,5	16538	26	
ARMO-C / 710-3 / 0,75 - 6A	945	710	0,75	2	18900	32	
ARMO-C / 710-6 / 1,1 - 6A	945	710	1,1	2,9	11025	12	
ARMO-C / 710-6 / 1,5 - 6A	945	710	1,5	3,6	13000	16	
ARMO-C / 710-6 / 2,2 - 6A	950	710	2,2	5,4	13750	22	
ARMO-C / 710-6 / 3 - 6A	950	710	3	6,9	18900	28	
ARMO-C / 710-6 / 4 - 6A	955	710	4	9	21000	32	
ARMO-C / 800-6 / 0,55 - 6A	930	800	0,55		13125	10	
ARMO-C / 800-6 / 1,1 - 6A	945	800	1,1	2,9	22050	22	
ARMO-C / 800-6 / 1,5 - 6A	945	800	1,5	3,6	25200	26	
ARMO-C / 800-6 / 2,2 - 6A	950	800	2,2	5,4	28350	32	
ARMO-C / 800-9 / 0,75 - 6A	945	800	0,75	2	14700	14	
ARMO-C / 800-9 / 1,1 - 6A	945	800	1,1	2,9	19950	20	
ARMO-C / 800-9 / 1,5 - 6A	945	800	1,5	3,6	23100	24	
ARMO-C / 800-9 / 2,2 - 6A	950	800	2,2	5,4	27300	30	
ARMO-C / 800-9 / 3 - 6A	950	800	3	6,9	28350	32	
ARMO-C / 900-6 / 1,1 - 6A	945	900	1,1	2,9	23100	14	
ARMO-C / 900-6 / 1,5 - 6A	945	900	1,5	3,6	25200	16	
ARMO-C / 900-6 / 2,2 - 6A	950	900	2,2	5,4	31500	22	
ARMO-C / 900-6 / 3 - 6A	950	900	3	6,9	36750	28	
ARMO-C / 900-6 / 4 - 6A	955	900	4	9	40950	32	
ARMO-C / 900-9 / 1,5 - 6A	945	900	1,5	3,6	23100	14	
ARMO-C / 900-9 / 2,2 - 6A	950	900	2,2	5,4	27300	20	
ARMO-C / 900-9 / 3 - 6A	950	900	3	6,9	35700	24	
ARMO-C / 900-9 / 4 - 6A	955	900	4	9	39900	30	
ARMO-C / 900-9 / 5,5 - 6A	985	900	5,5	12,3	43050	32	
ARMO-C / 1000-6 / 1,5 - 6A	945	1000	1,5	3,6	26250	10	
ARMO-C / 1000-6 / 2,2 - 6A	950	1000	2,2	5,4	34650	16	
ARMO-C / 1000-6 / 3 - 6A	950	1000	3	6,9	44100	22	
ARMO-C / 1000-6 / 4 - 6A	955	1000	4	9	49350	26	
ARMO-C / 1000-6 / 5,5 - 6A	985	1000	5,5	12,3	55650	32	
ARMO-C / 1000-9 / 2,2 - 6A	950	1000	2,2	5,4	32550	14	
ARMO-C / 1000-9 / 3 - 6A	950	1000	3	6,9	39900	20	
ARMO-C / 1000-9 / 4 - 6A	955	1000	4	9	43050	22	
ARMO-C / 1000-9 / 5,5 - 6A	985	1000	5,5	12,3	52500	28	
ARMO-C / 1000-9 / 7,5 - 6A	960	1000	7,5	15	57750	32	
ARMO-C / 1250-6 / 4 - 6A	955	1250	4	9	60900	12	
ARMO-C / 1250-6 / 5,5 - 6A	985	1250	5,5	12,3	63300	16	
ARMO-C / 1250-6 / 7,5 - 6A	960	1250	7,5	15	76650	20	
ARMO-C / 1250-6 / 11 - 6A	960	1250	11	22	92400	26	
ARMO-C / 1250-6 / 15 - 6A	965	1250	15	29	105000	32	
ARMO-C / 1250-9 / 7,5 - 6A	960	1250	7,5	15	73500	16	
ARMO-C / 1250-9 / 11 - 6A	960	1250	11	22	88200	22	
ARMO-C / 1250-9 / 15 - 6A	965	1250	15	29	105000	28	
ARMO-C / 1250-9 / 18,5 - 6A	970	1250	18,5	36,5	115500	32	

Accessories

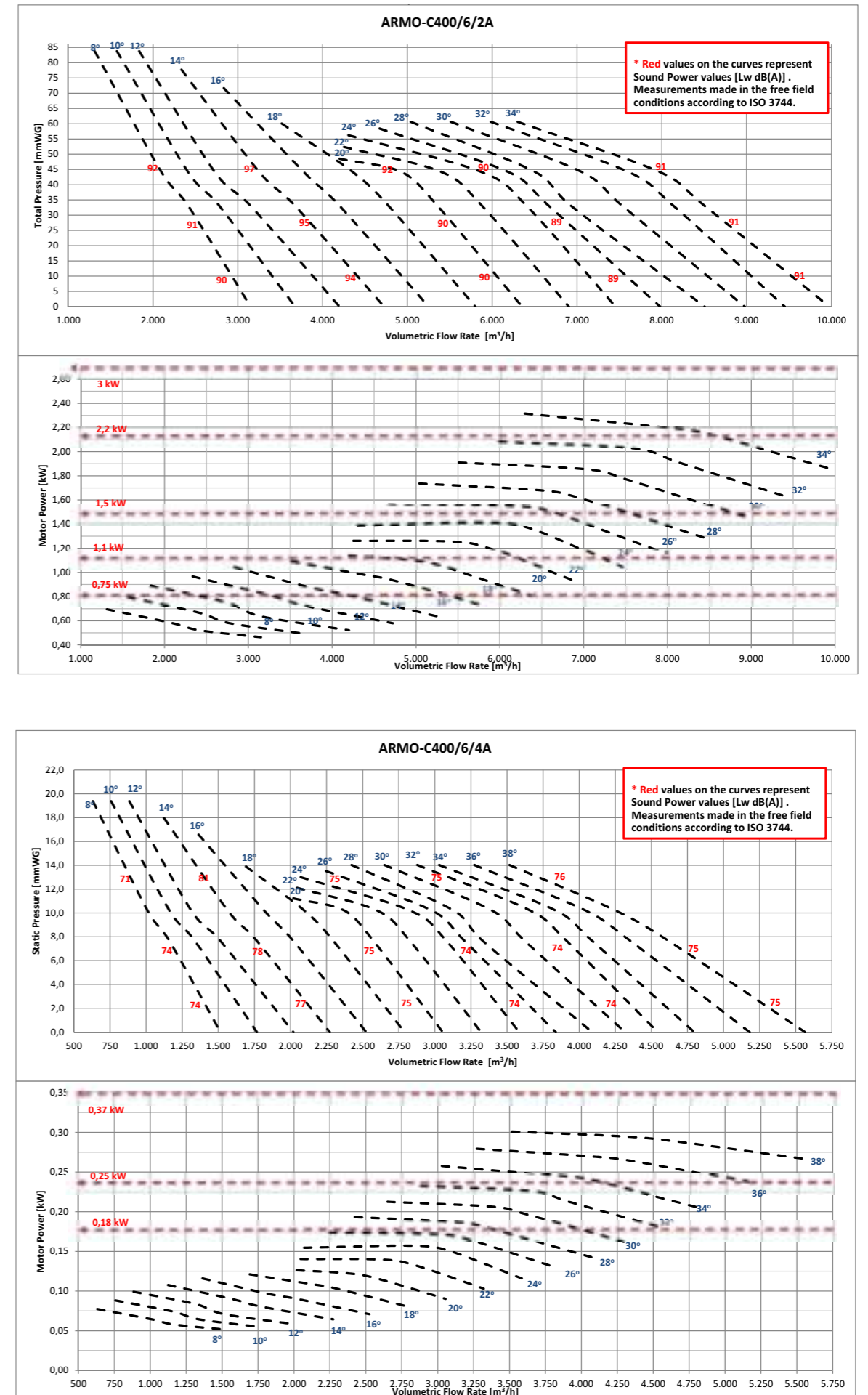

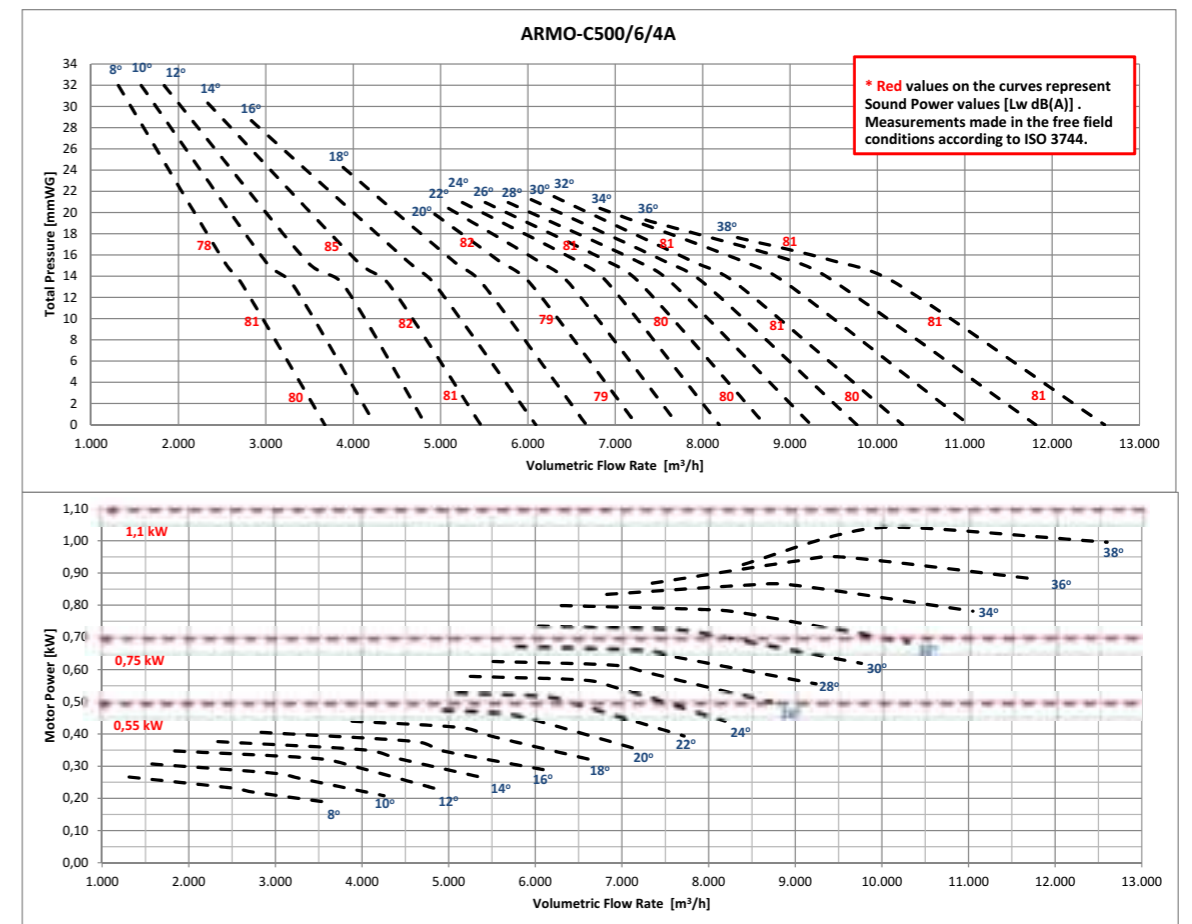
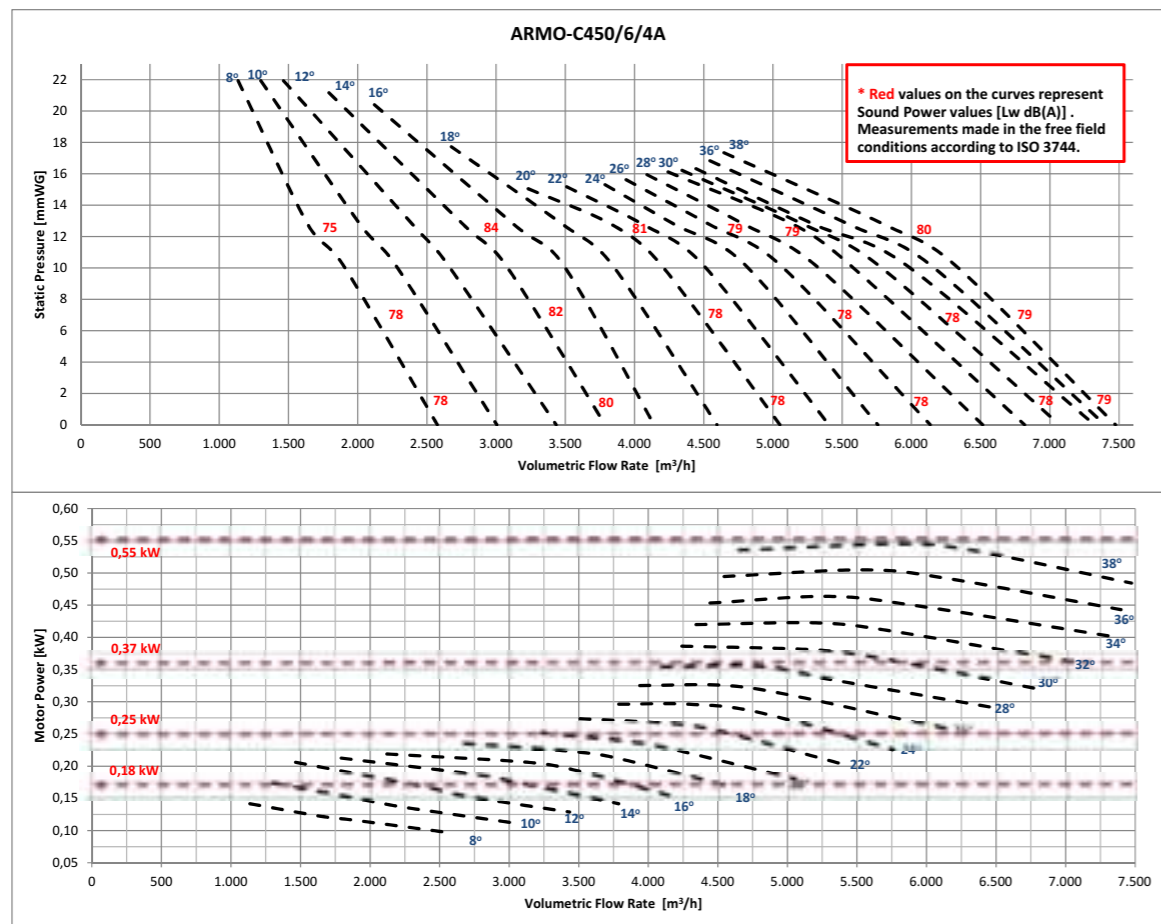
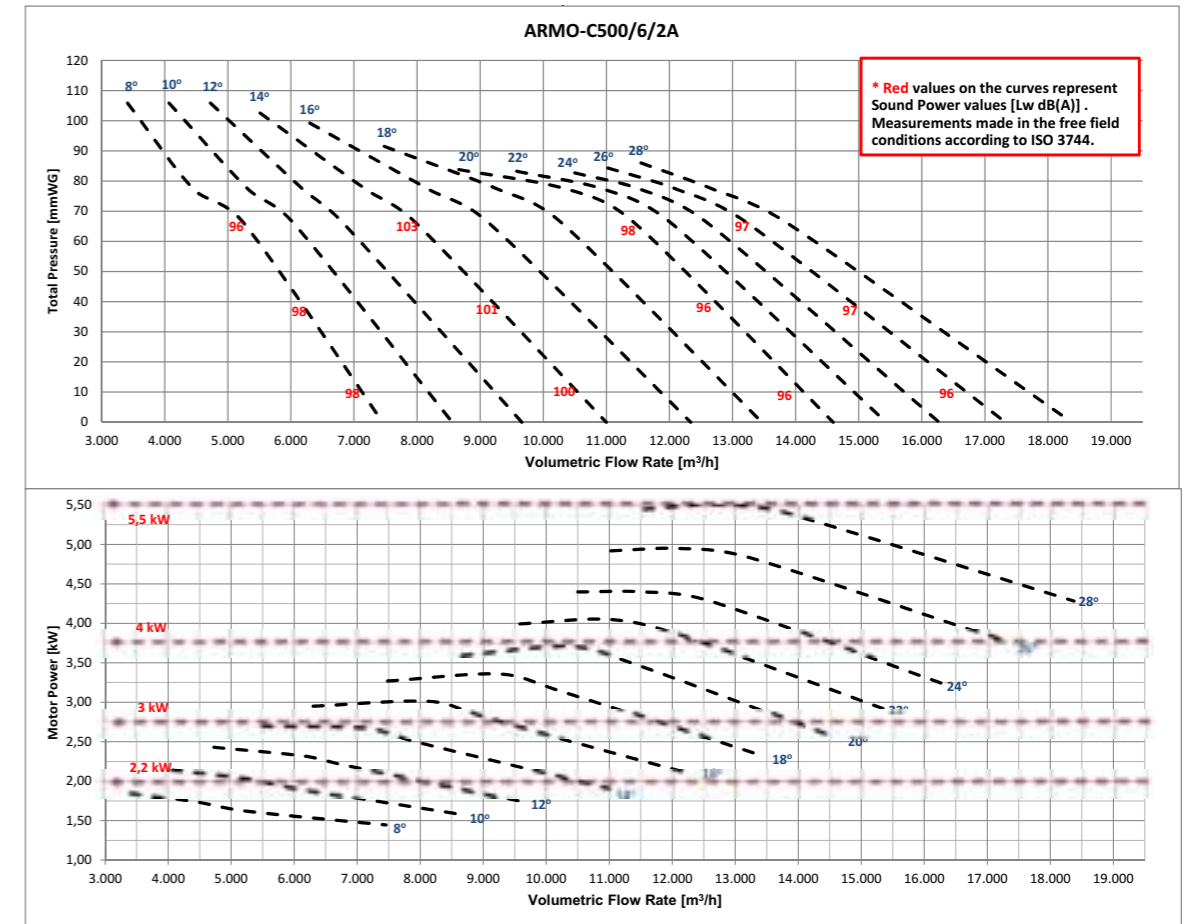
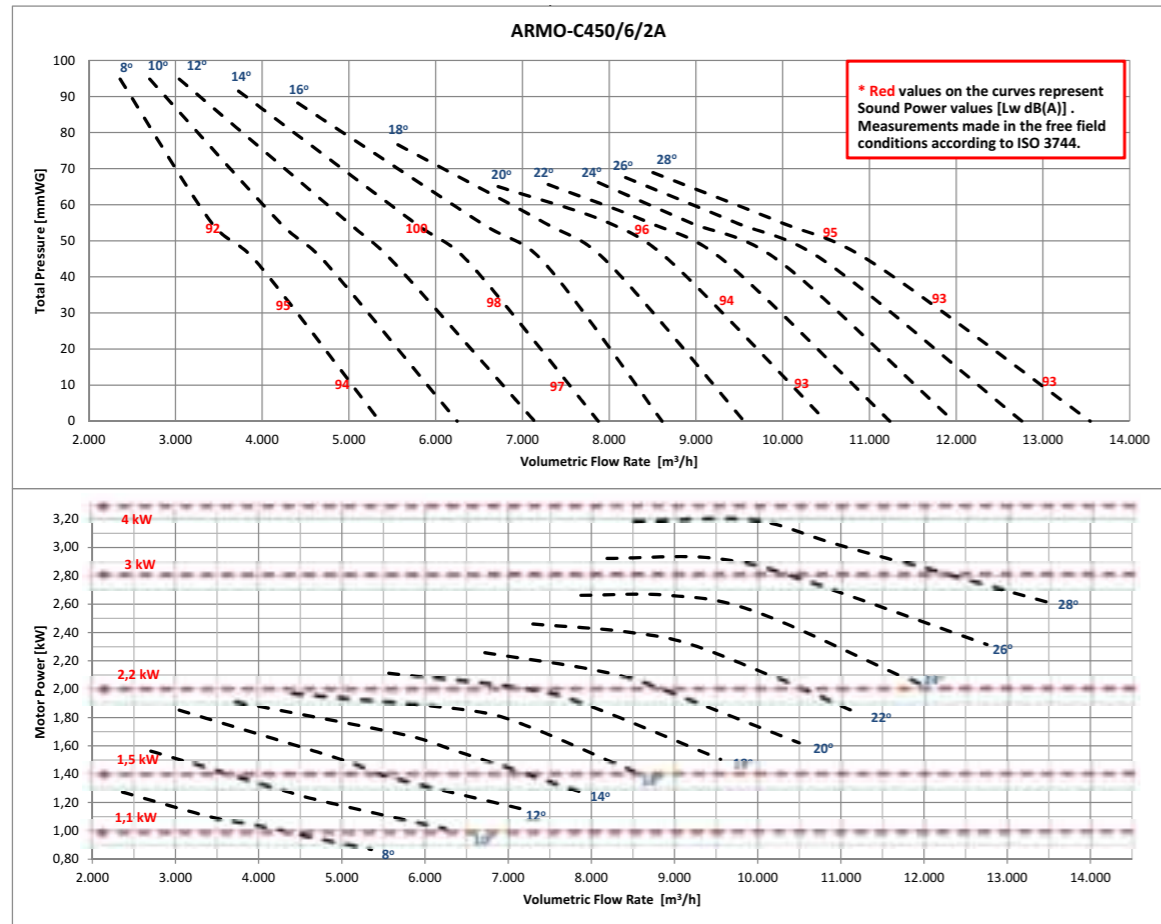

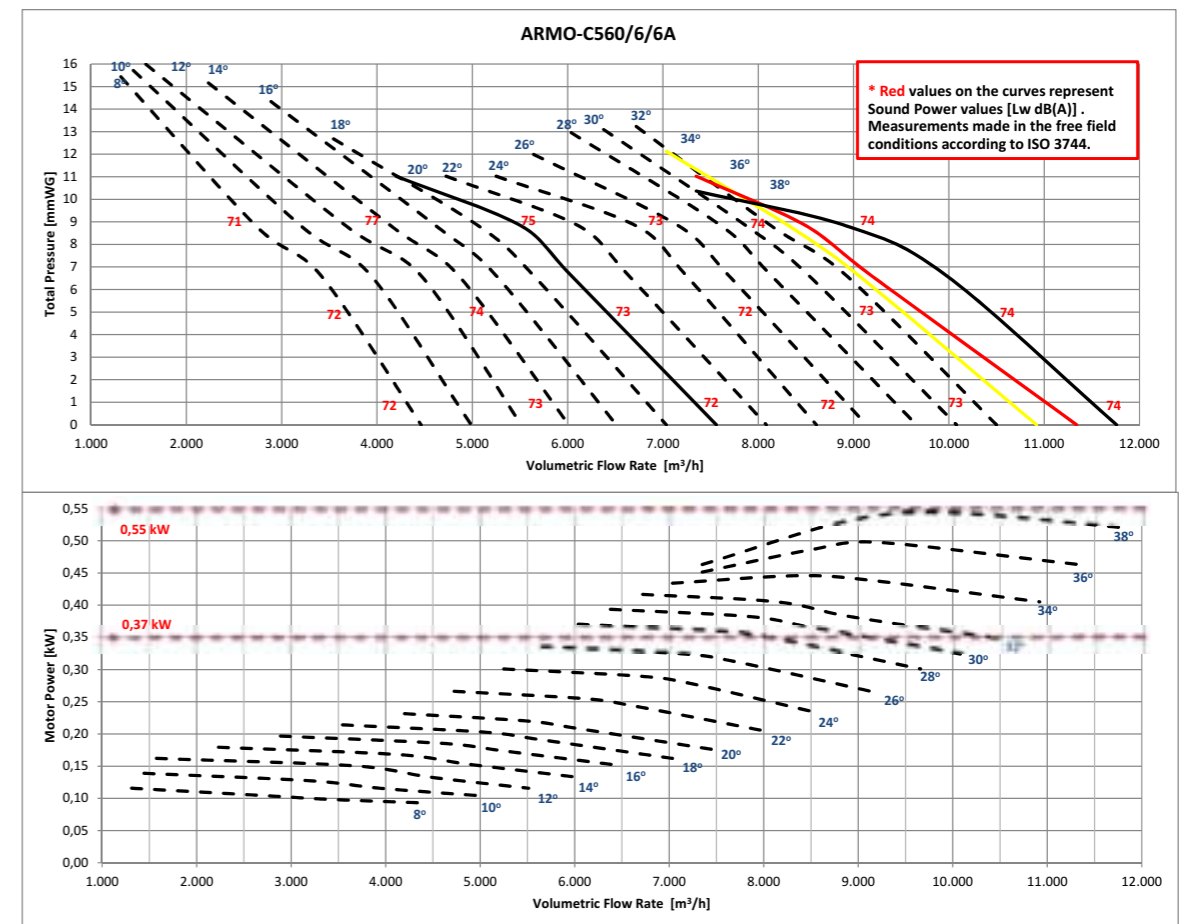
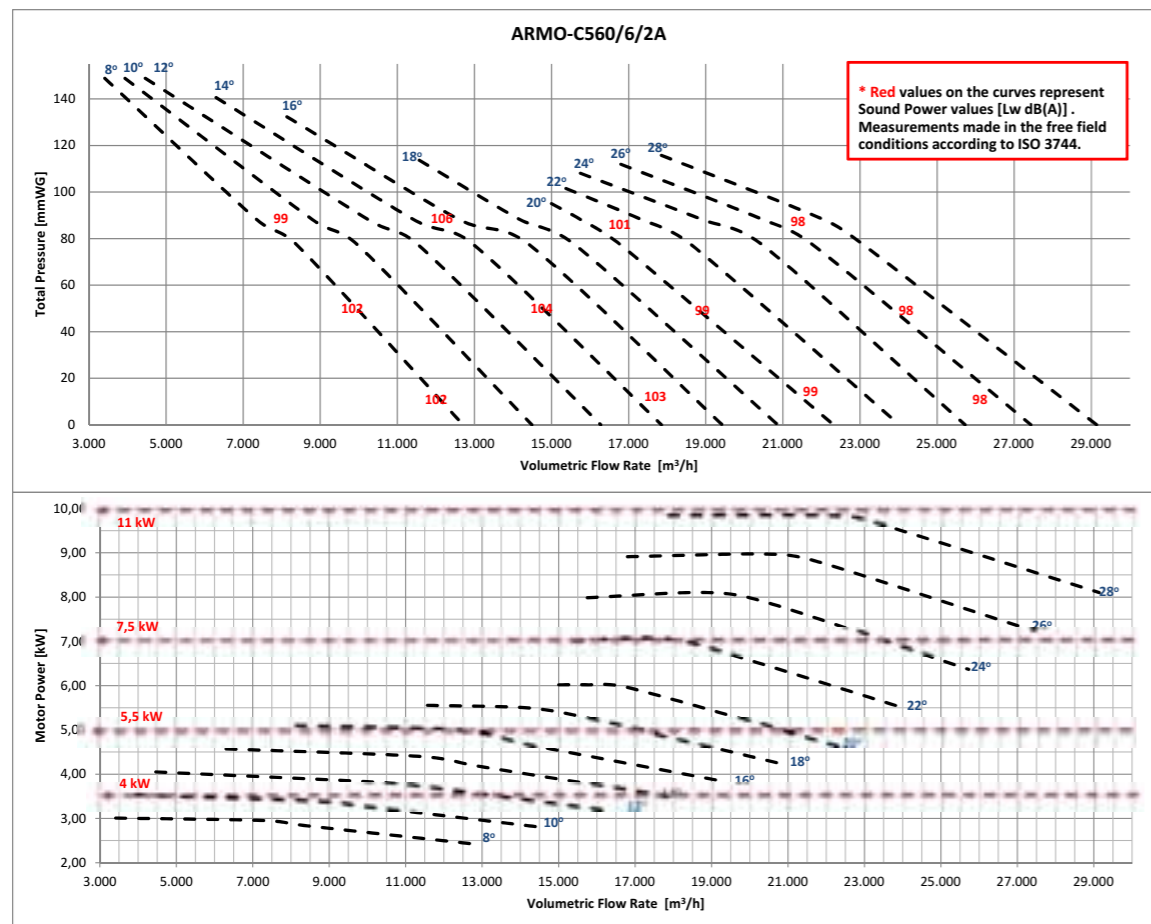
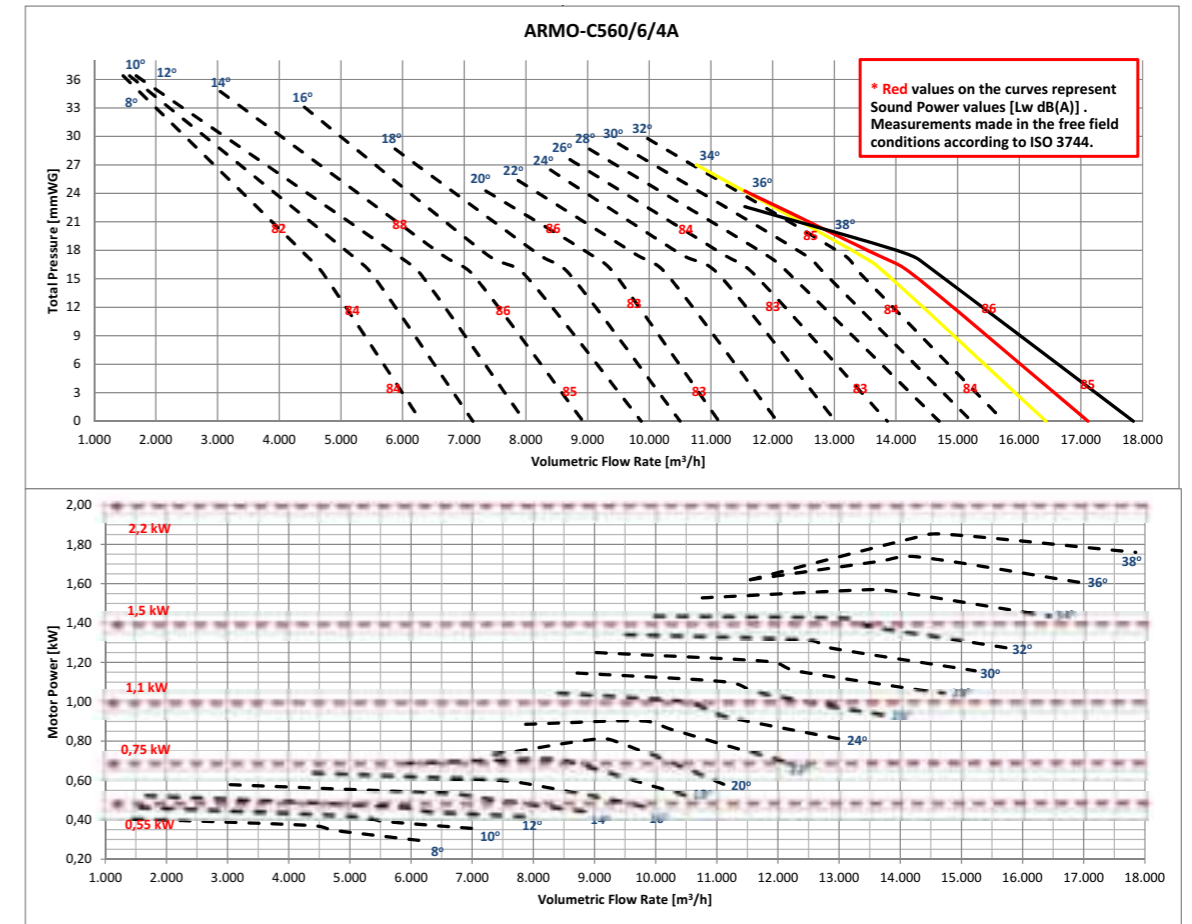
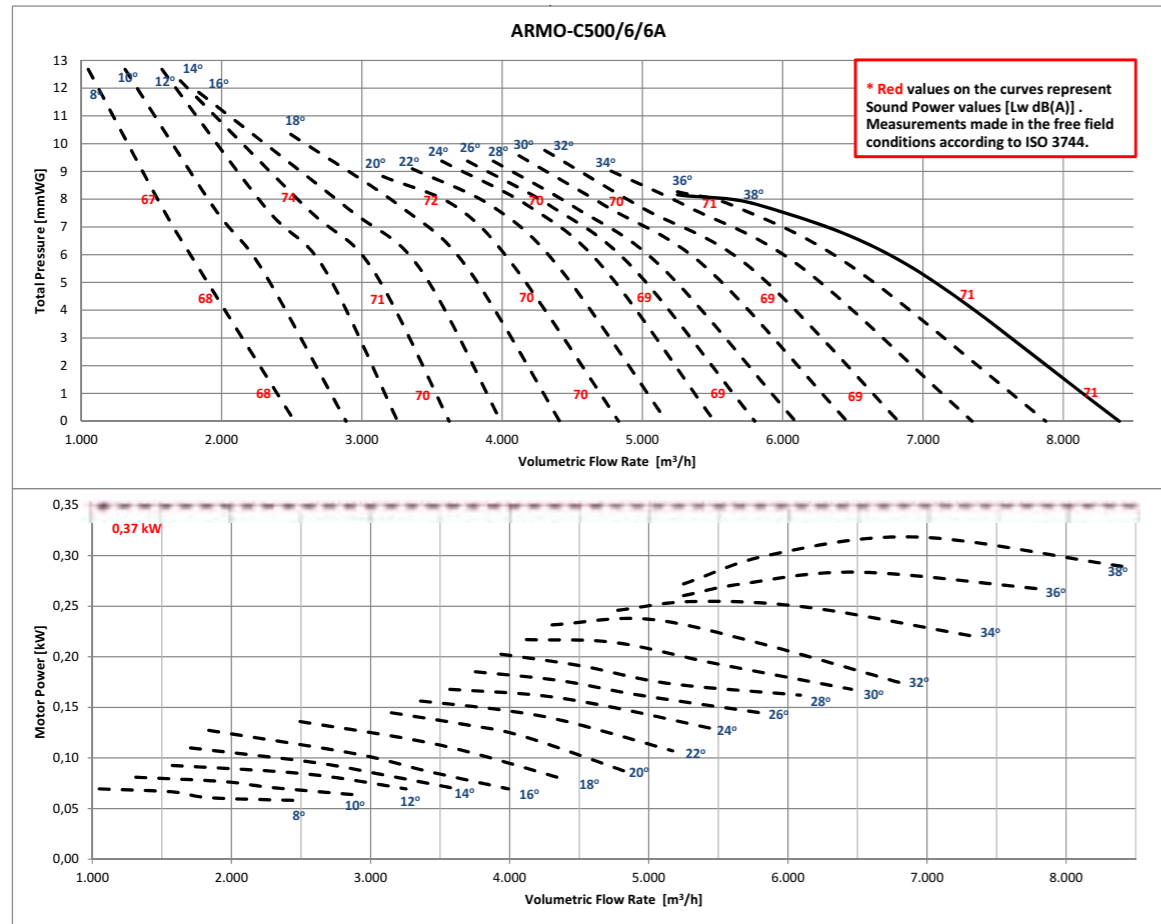

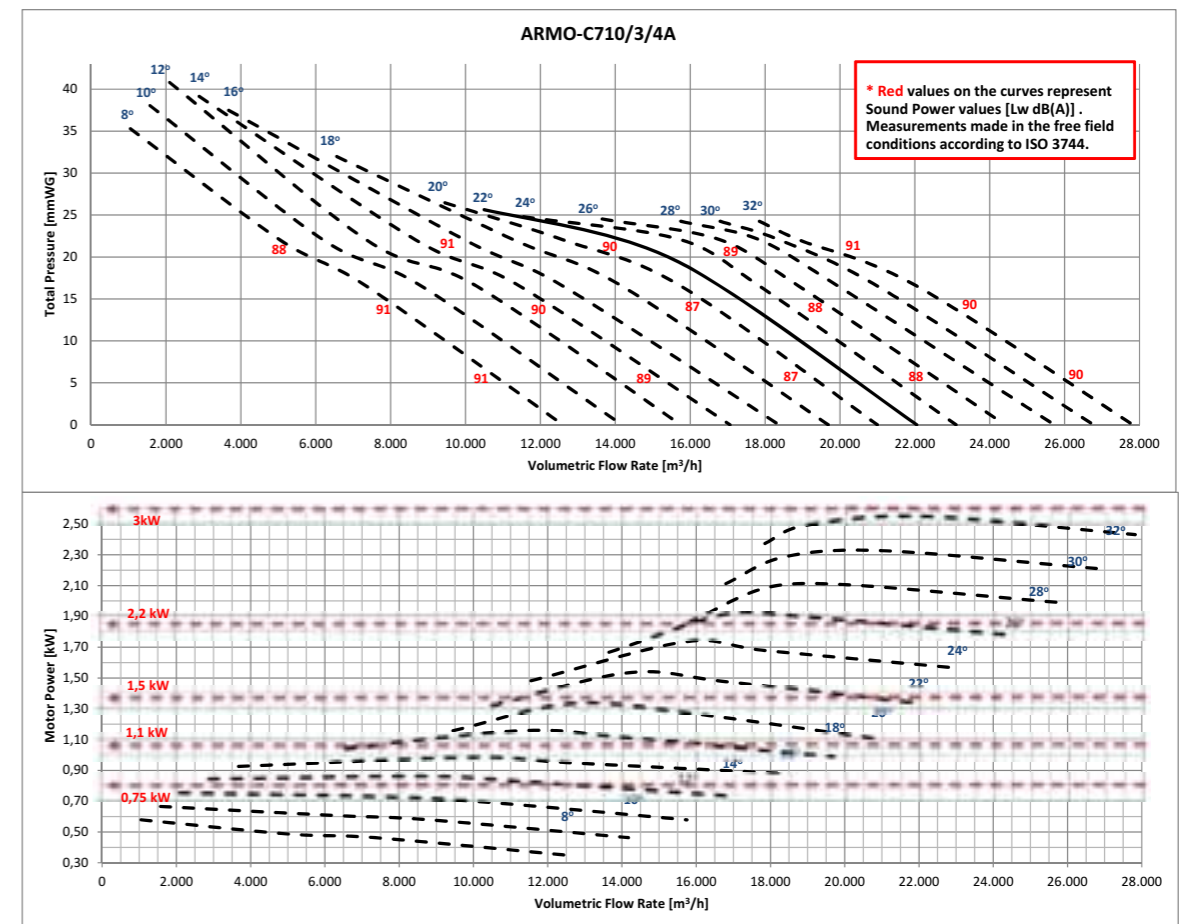
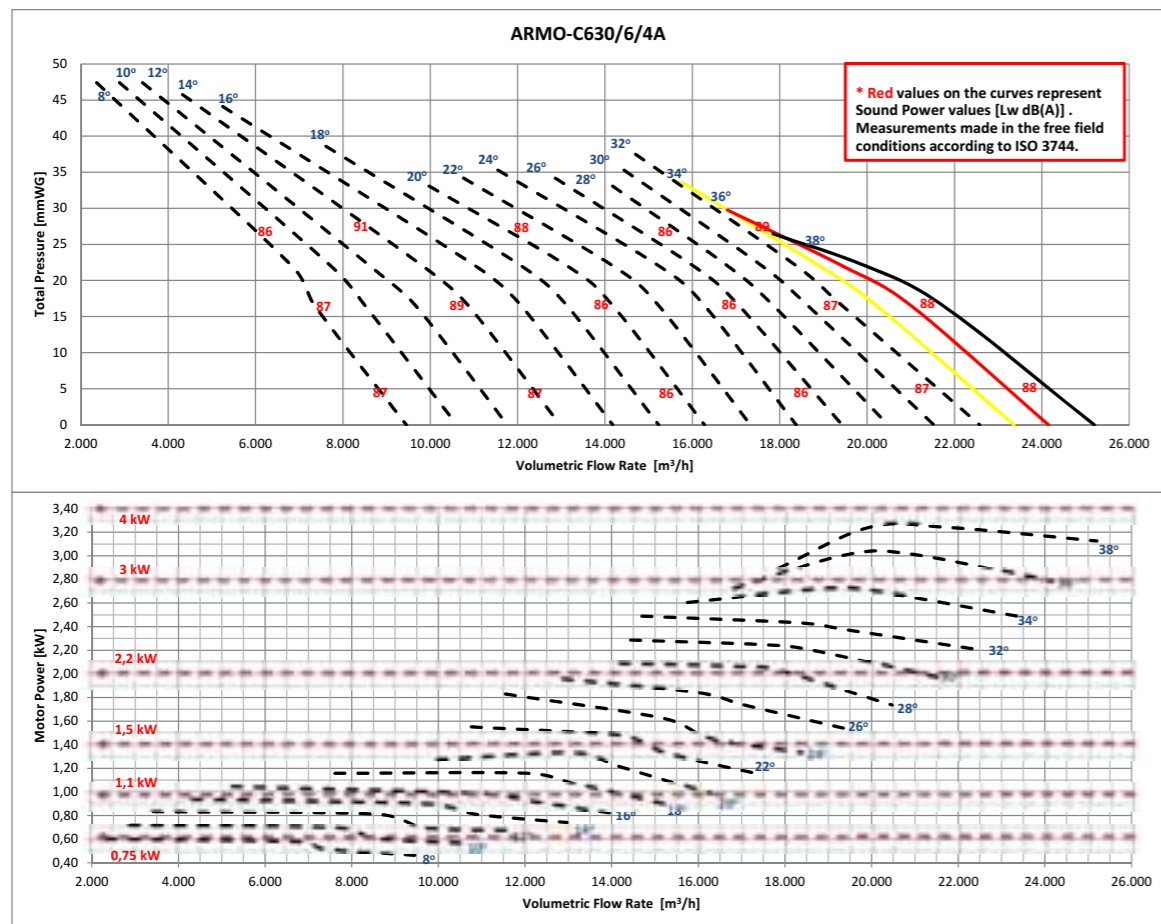
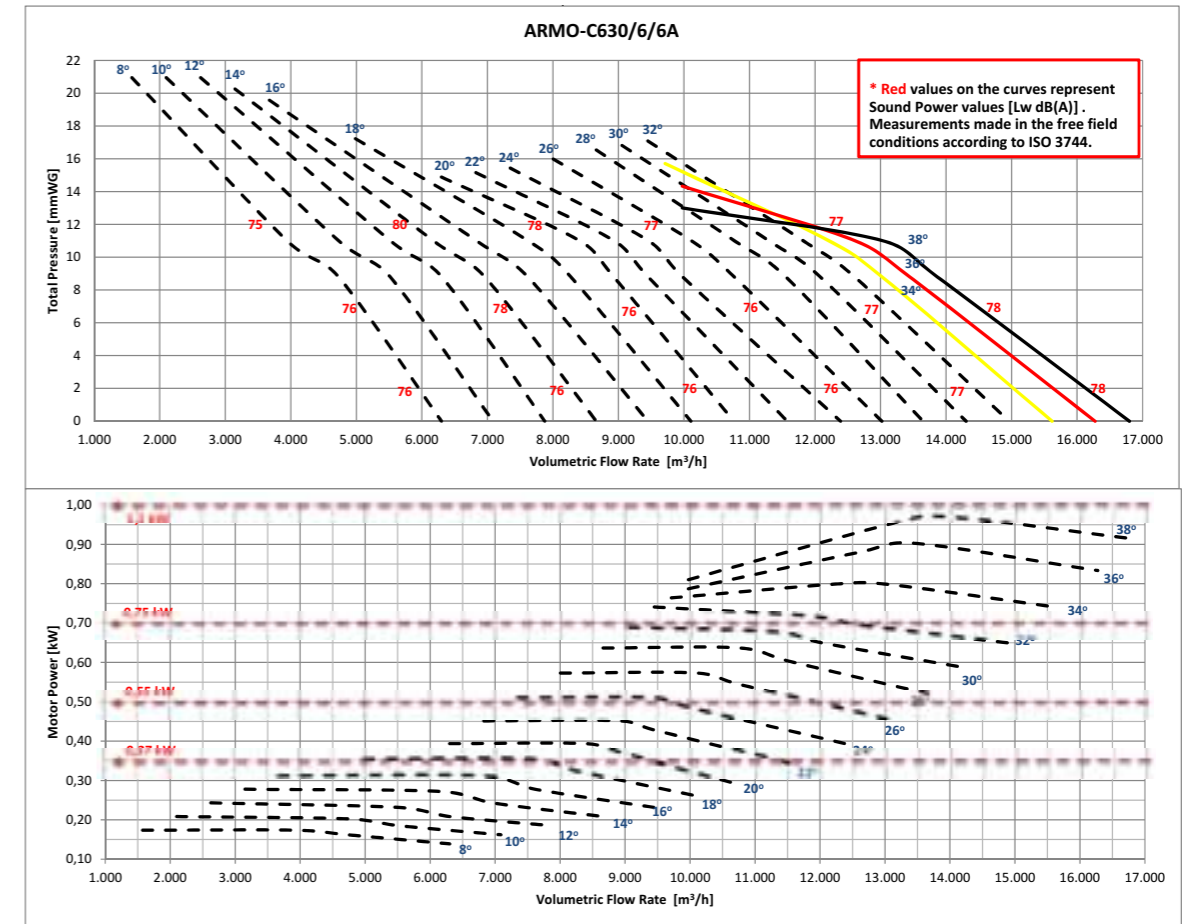
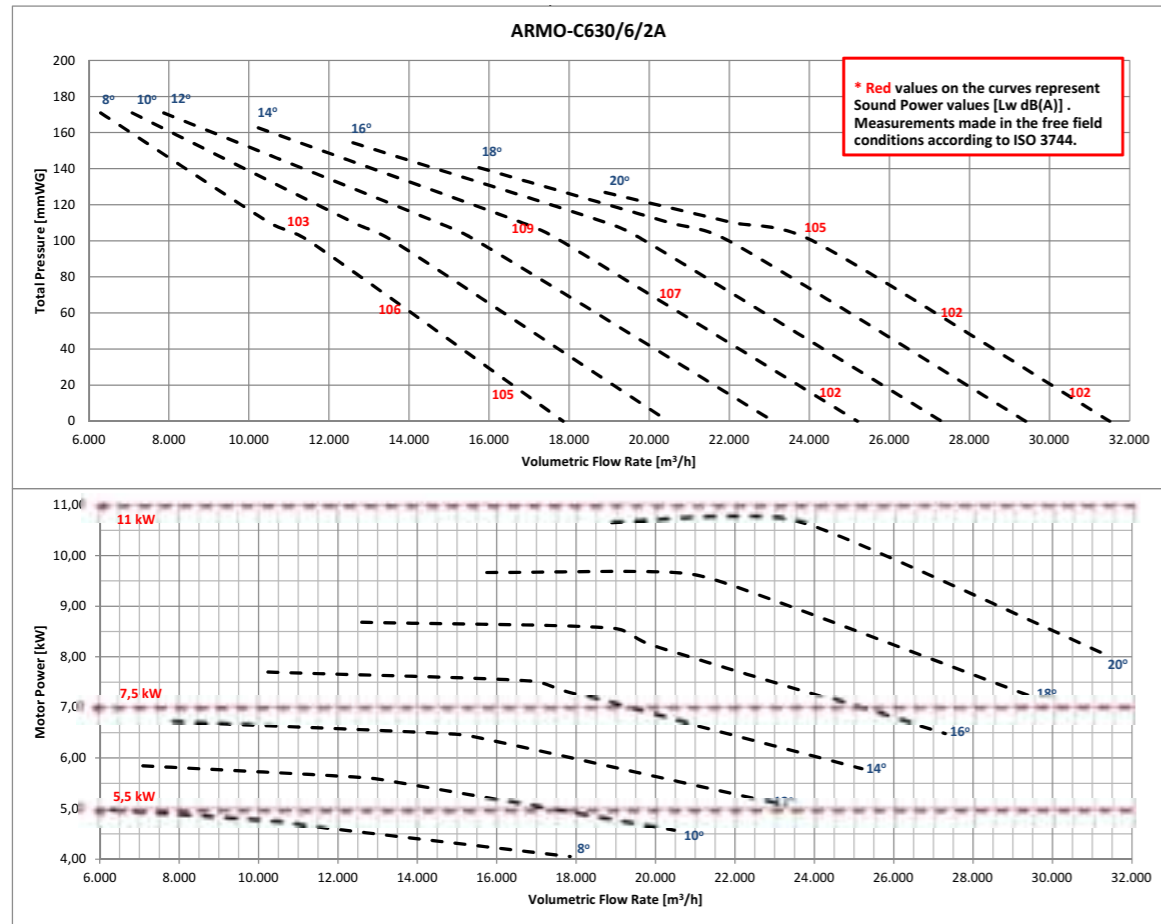

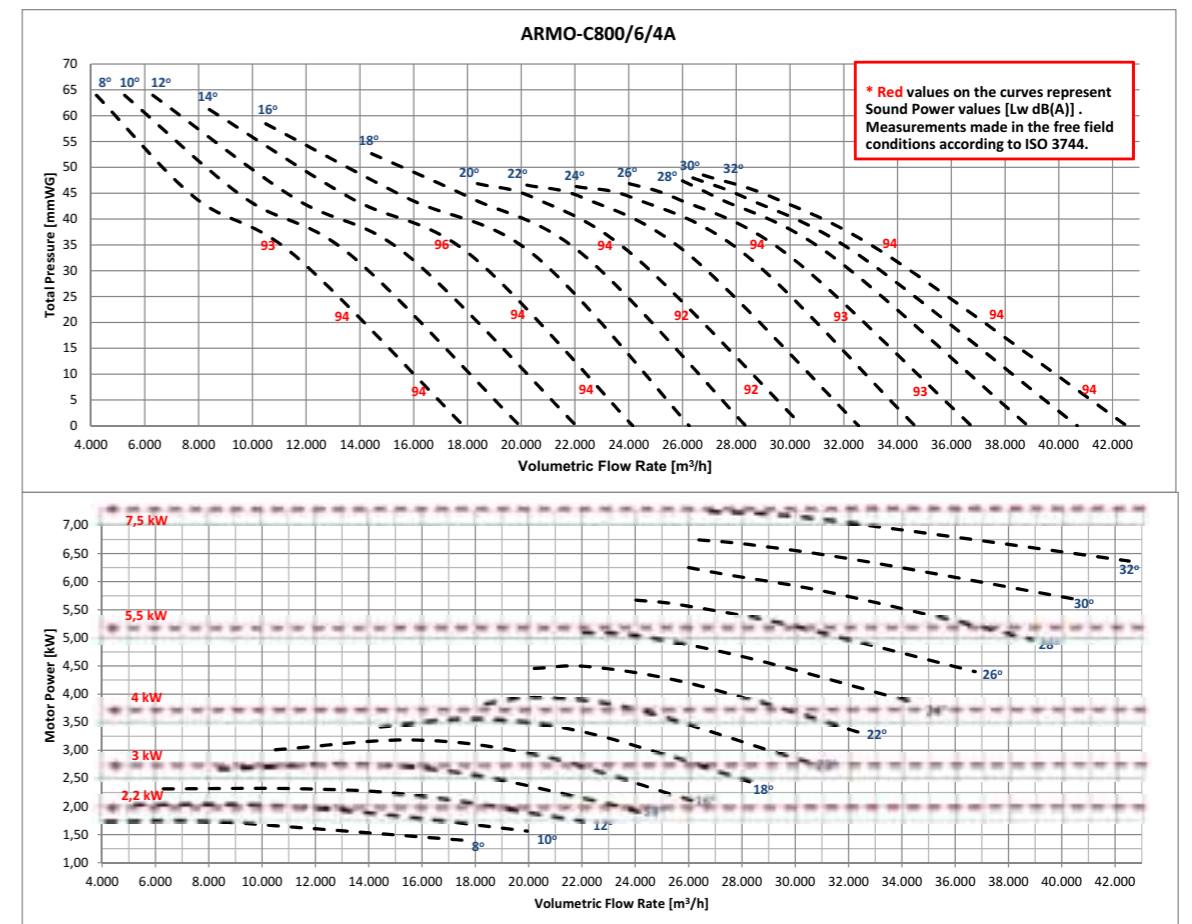
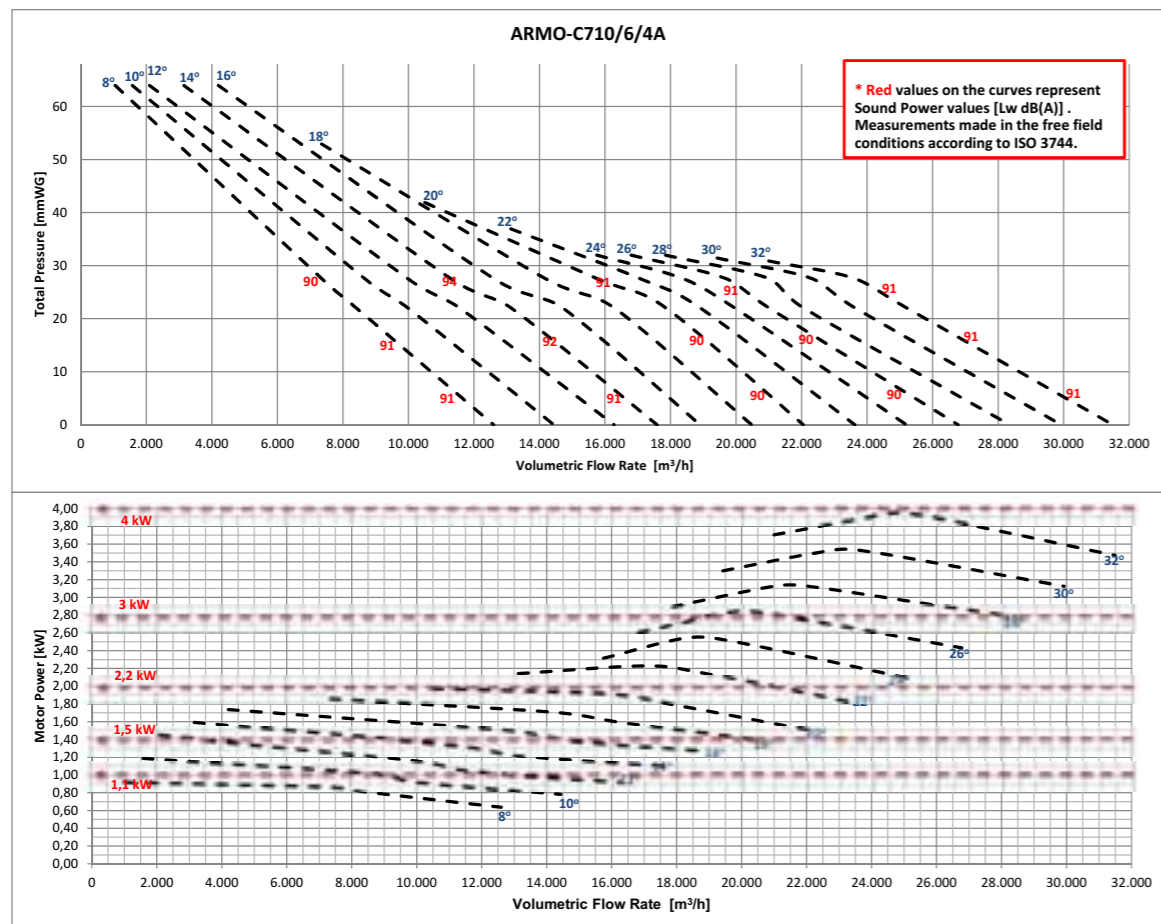
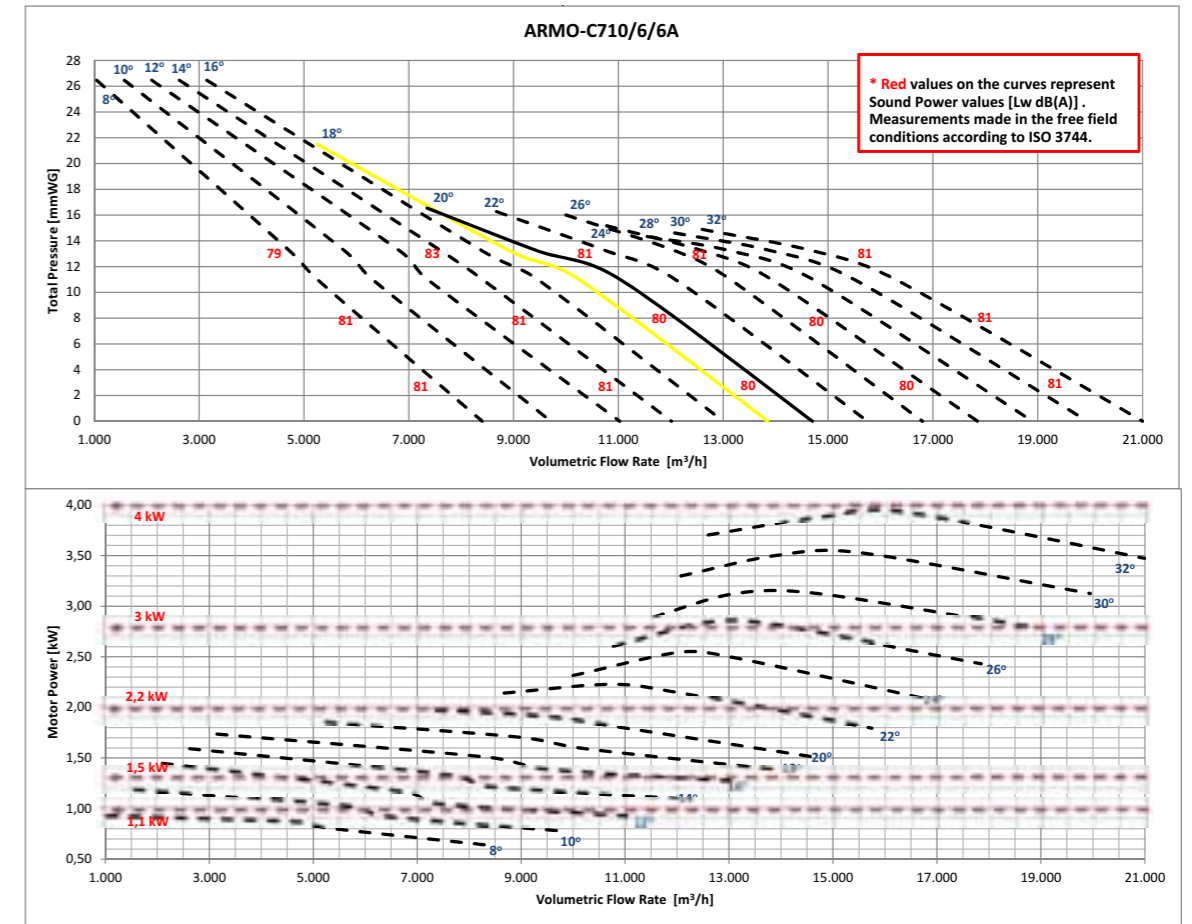
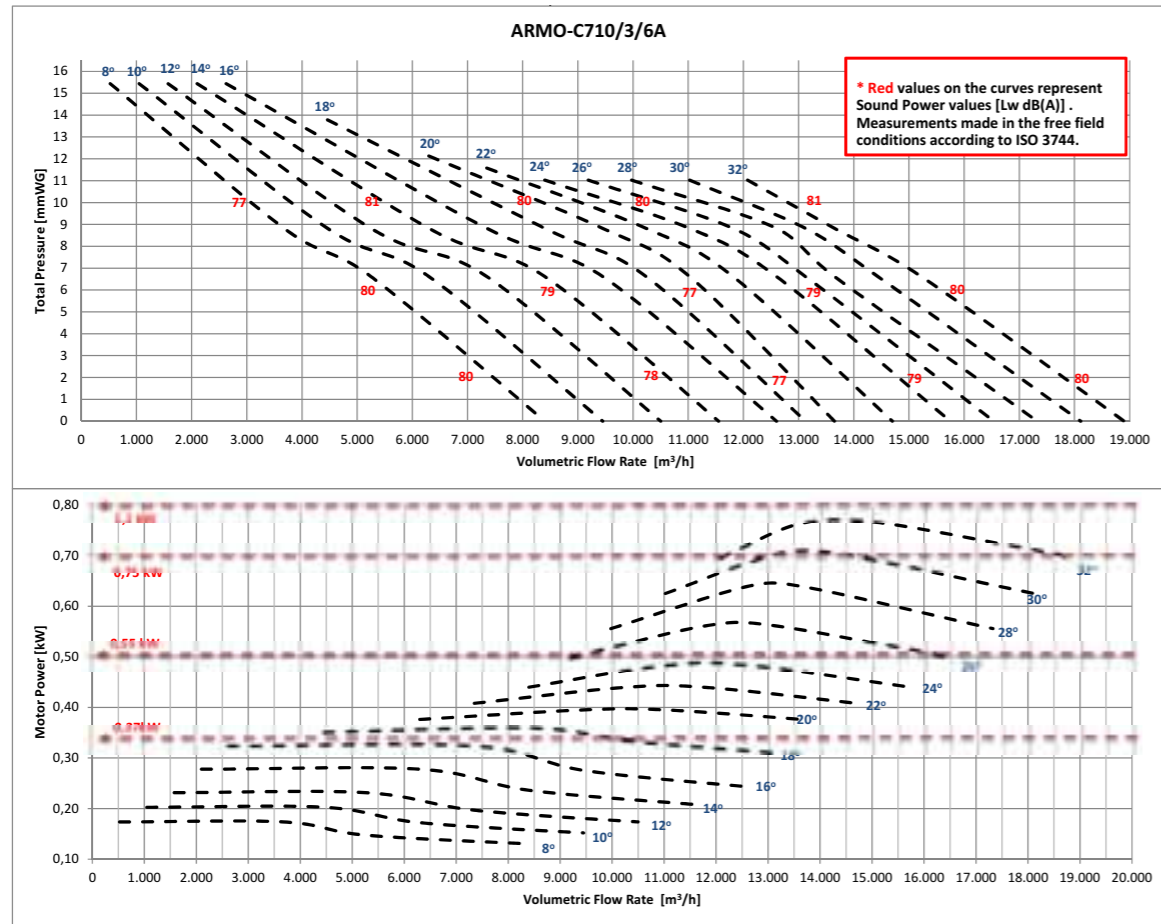

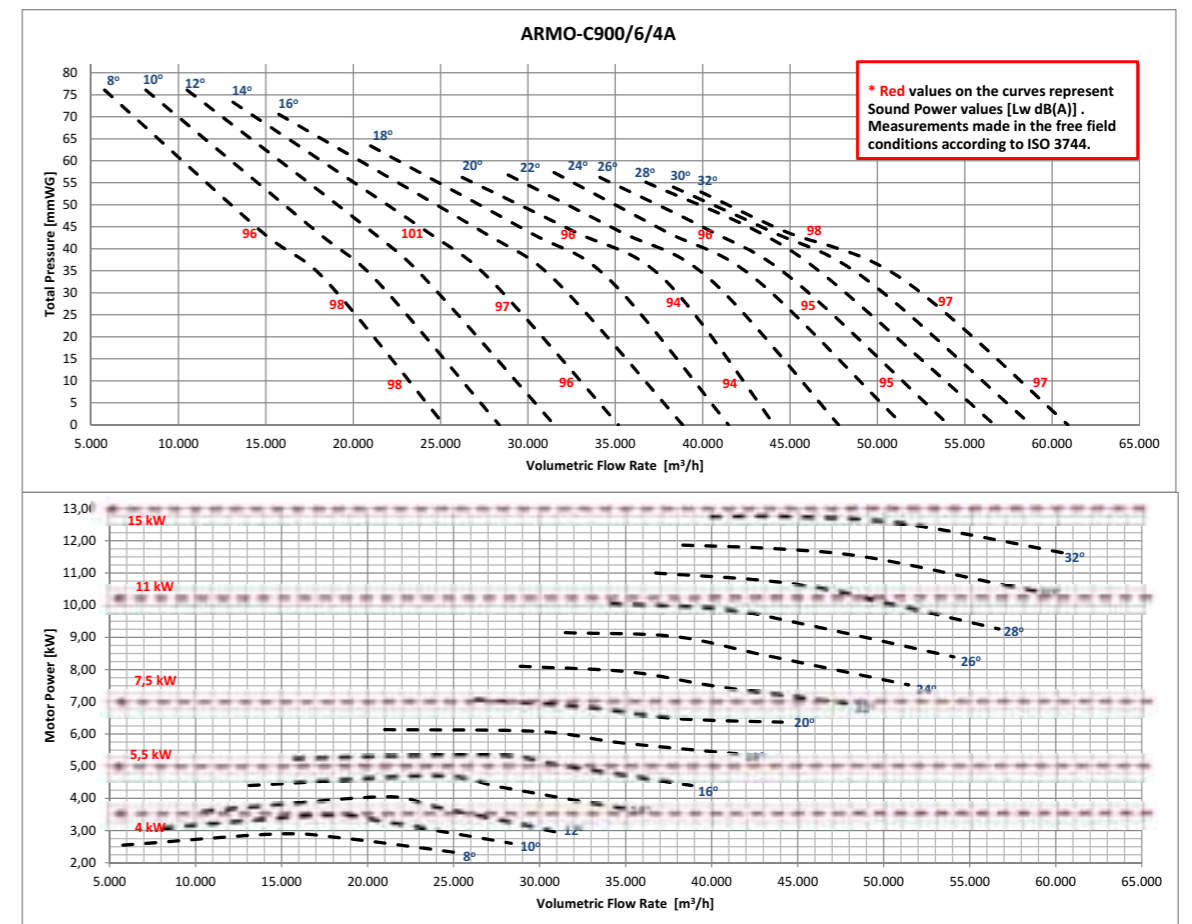
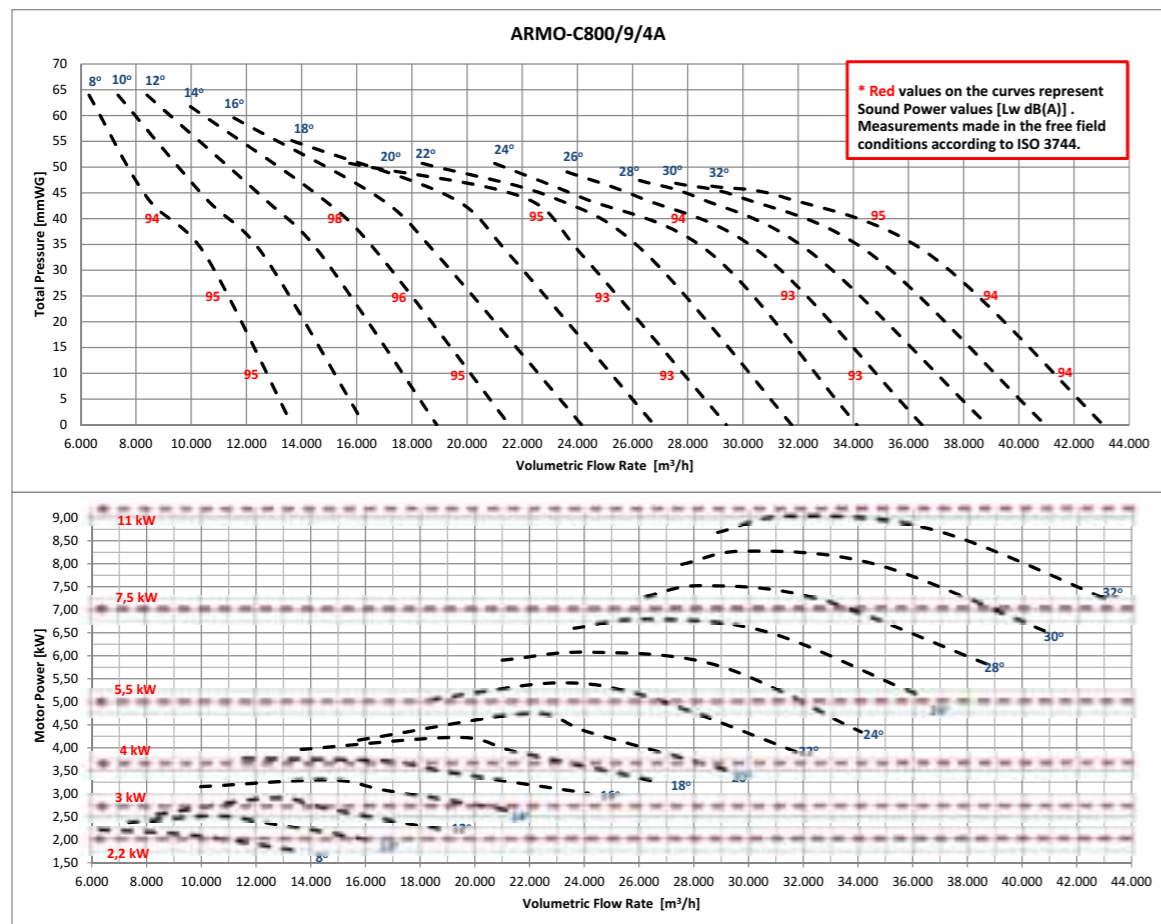
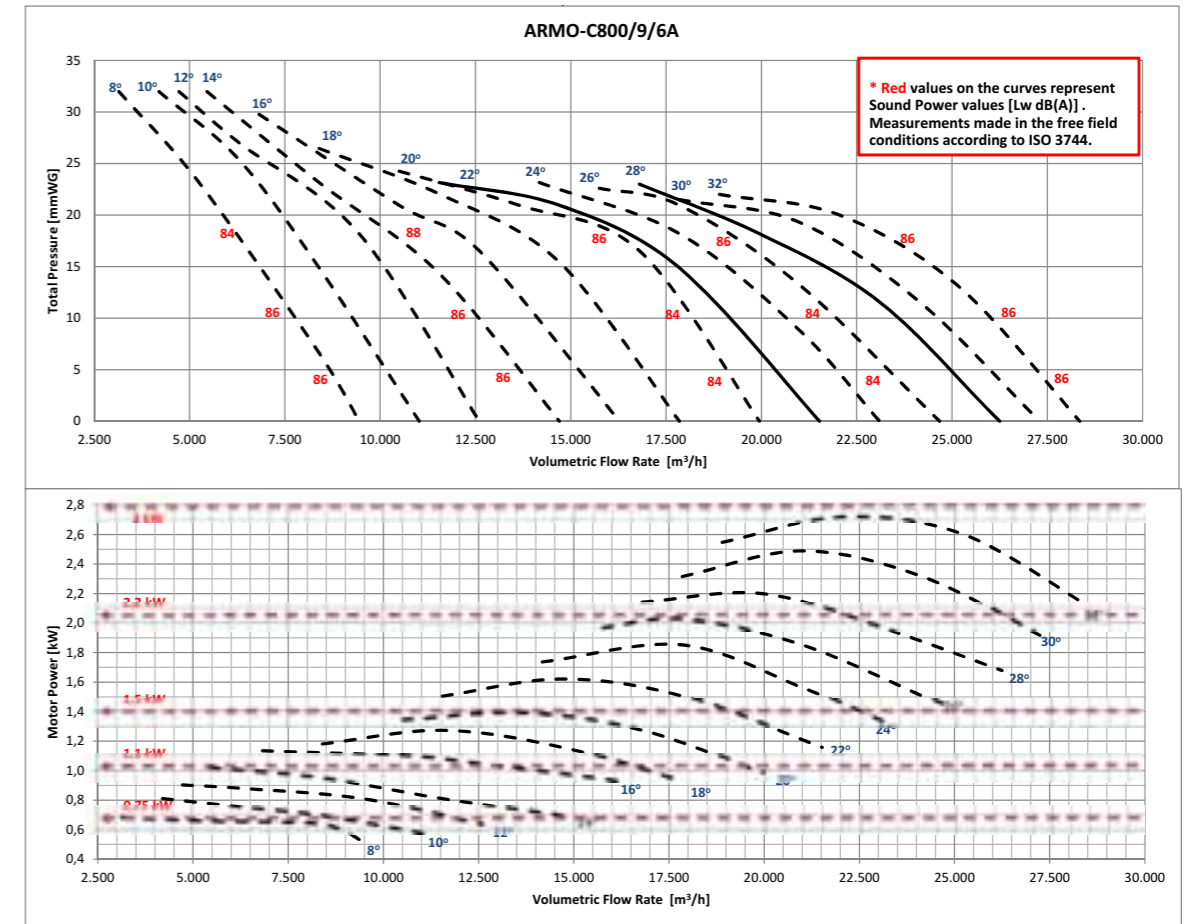
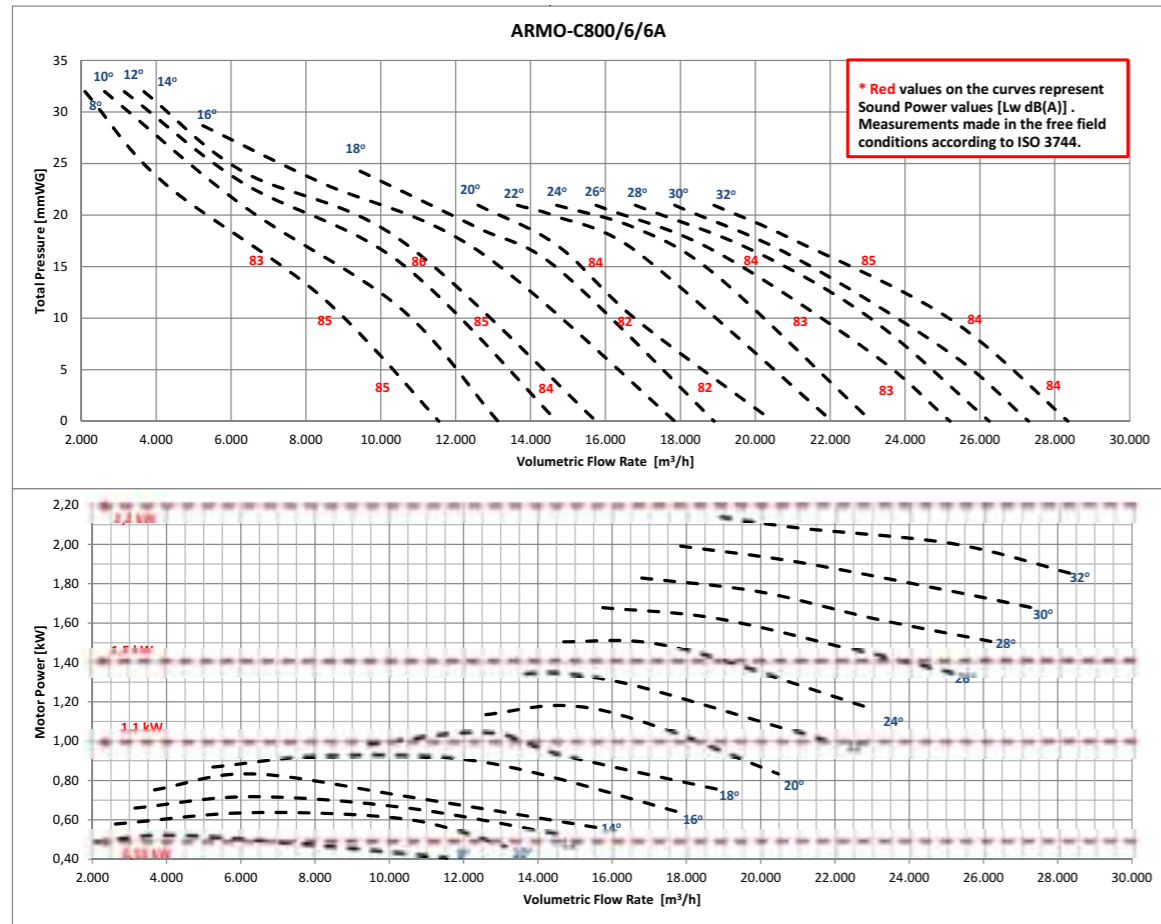

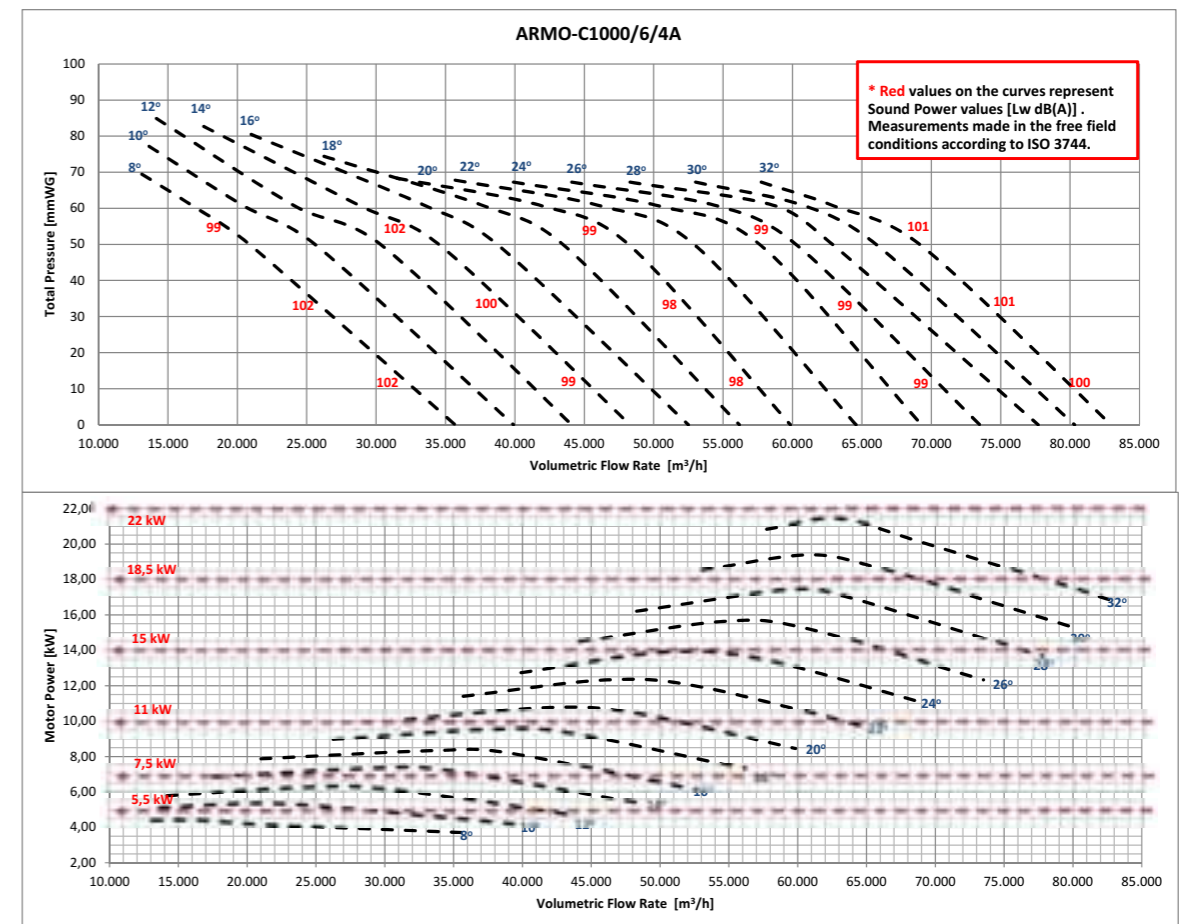
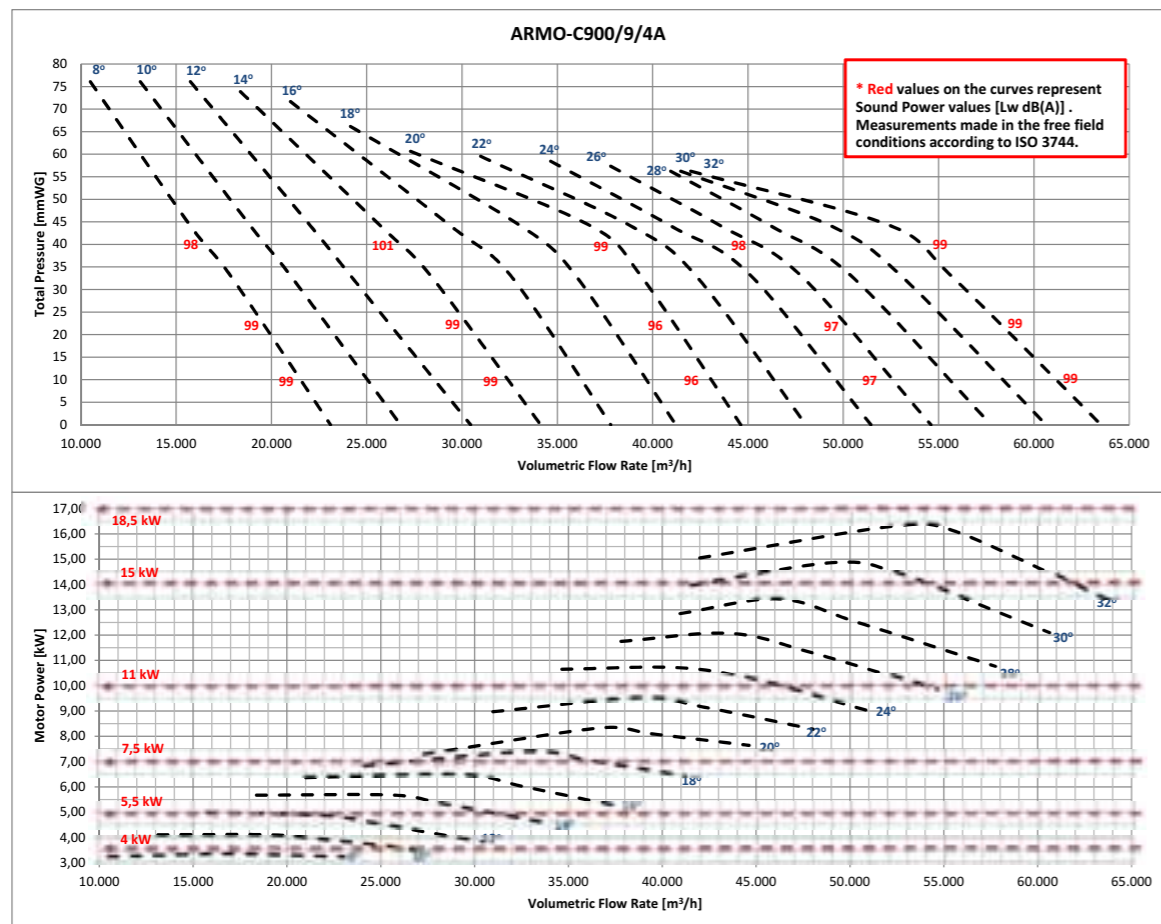
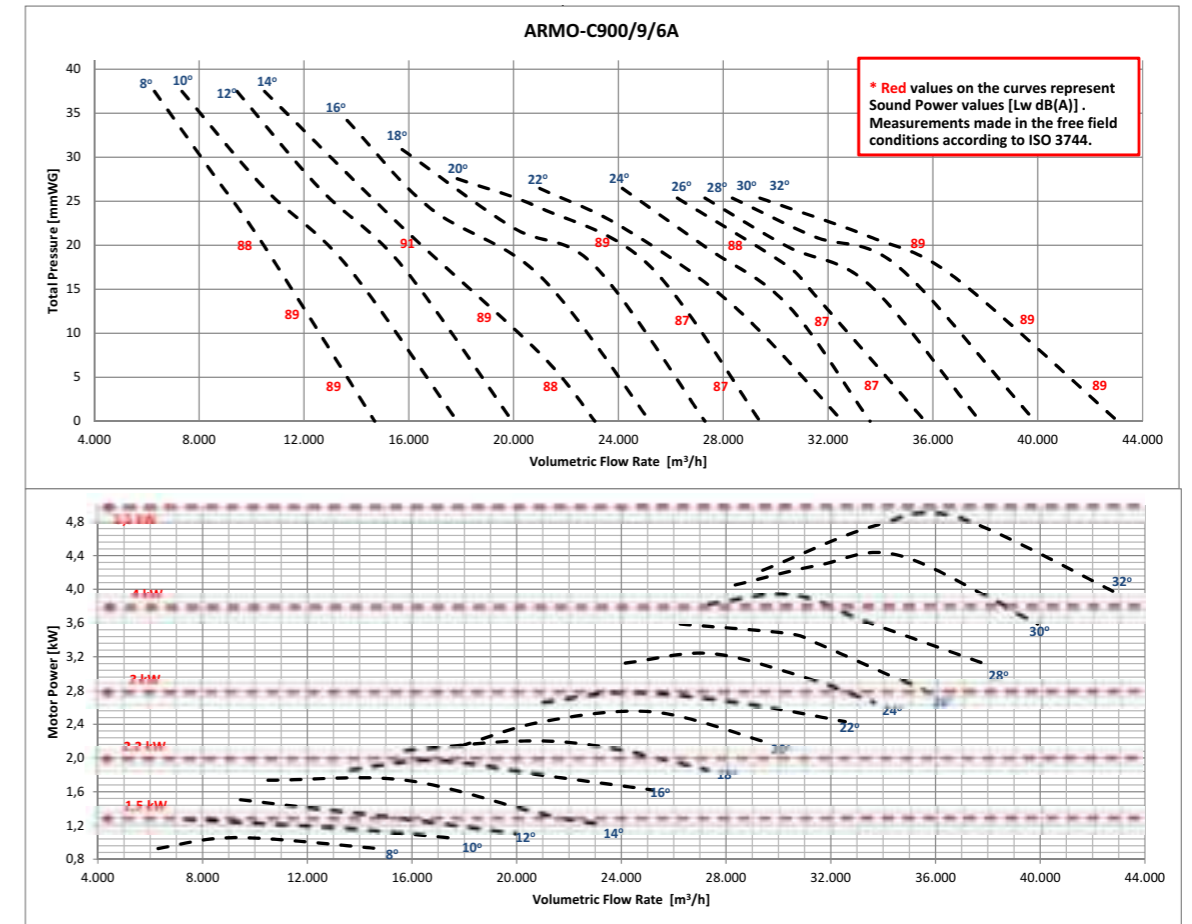
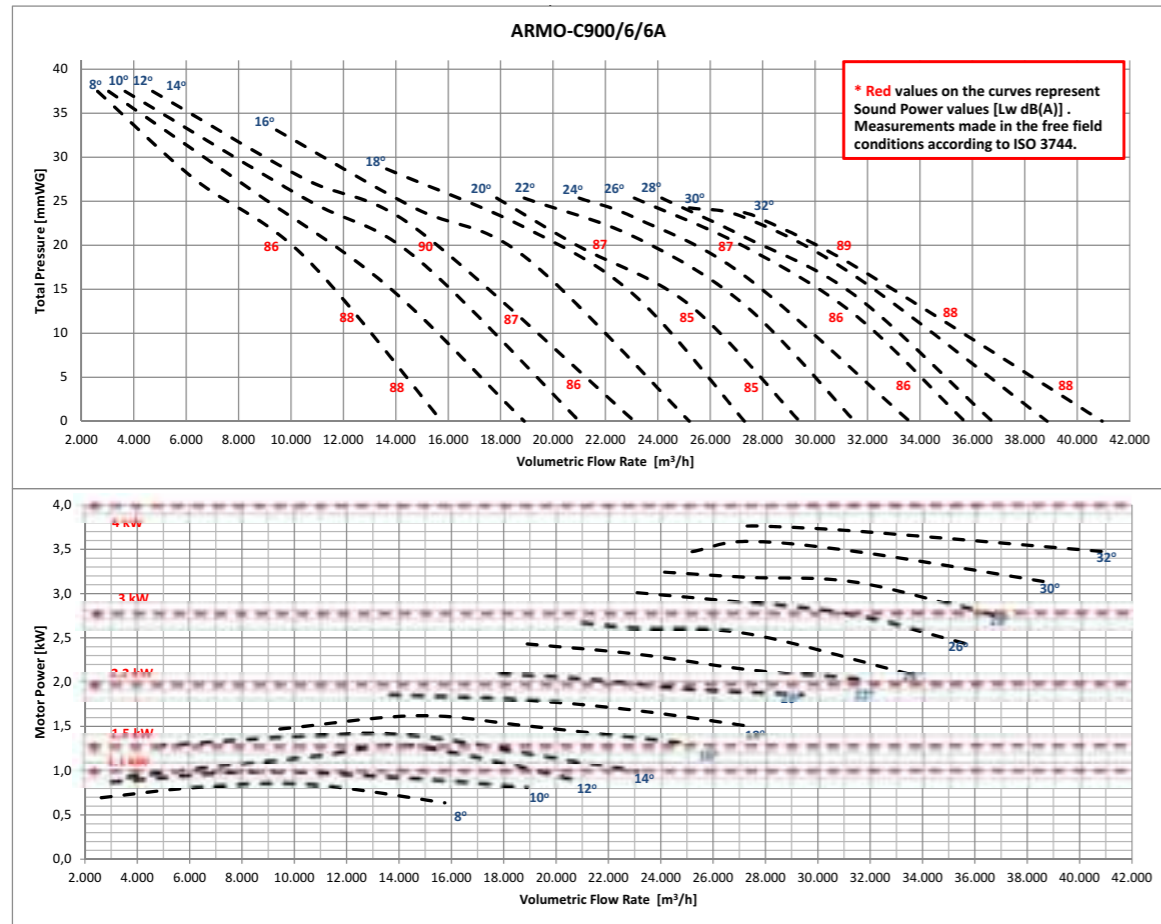

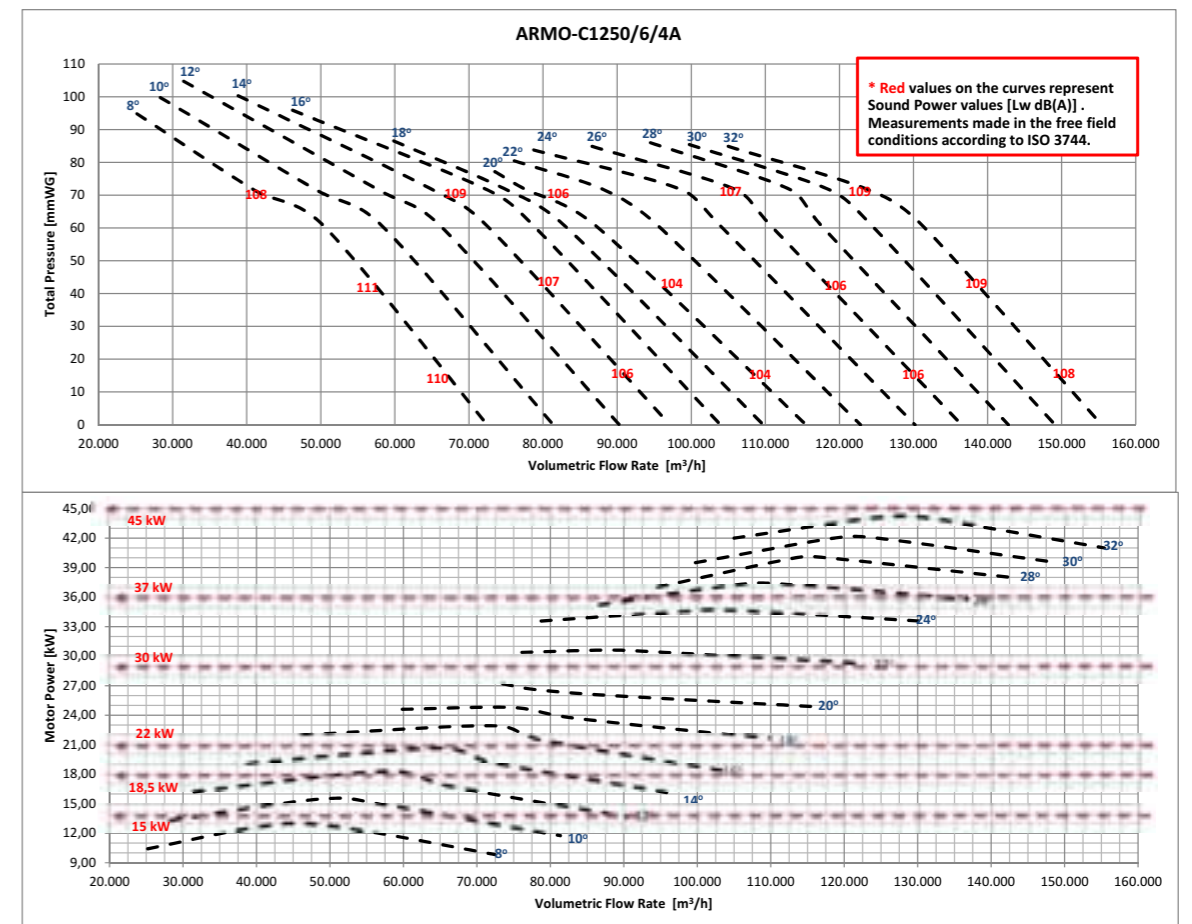
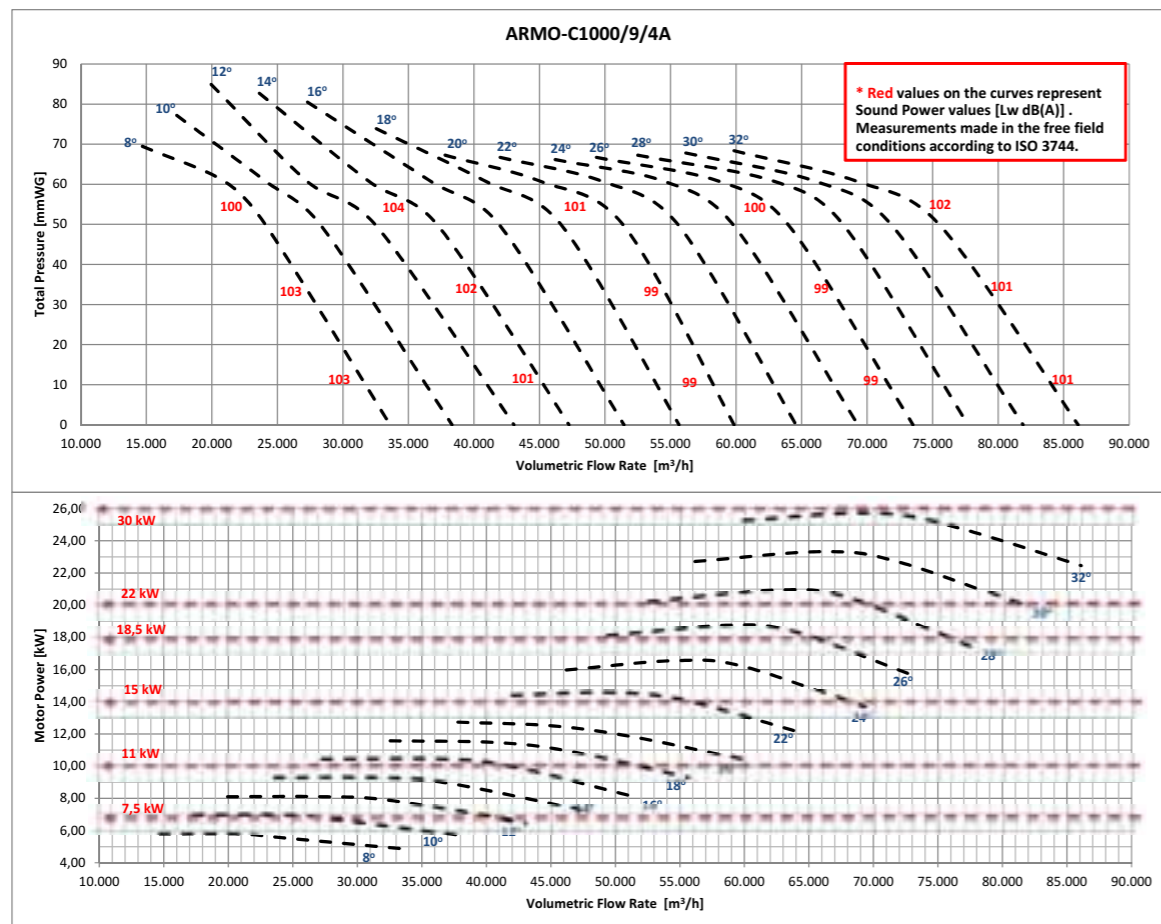
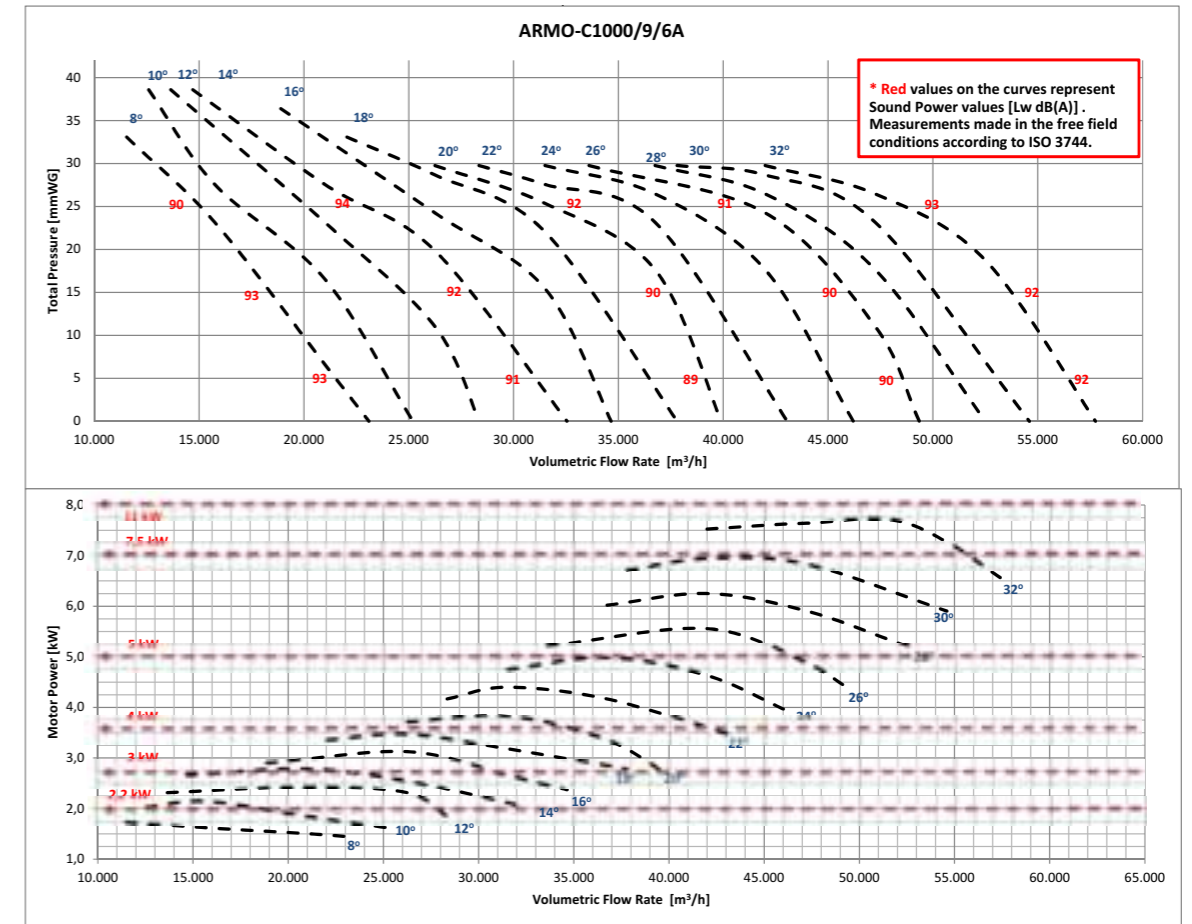
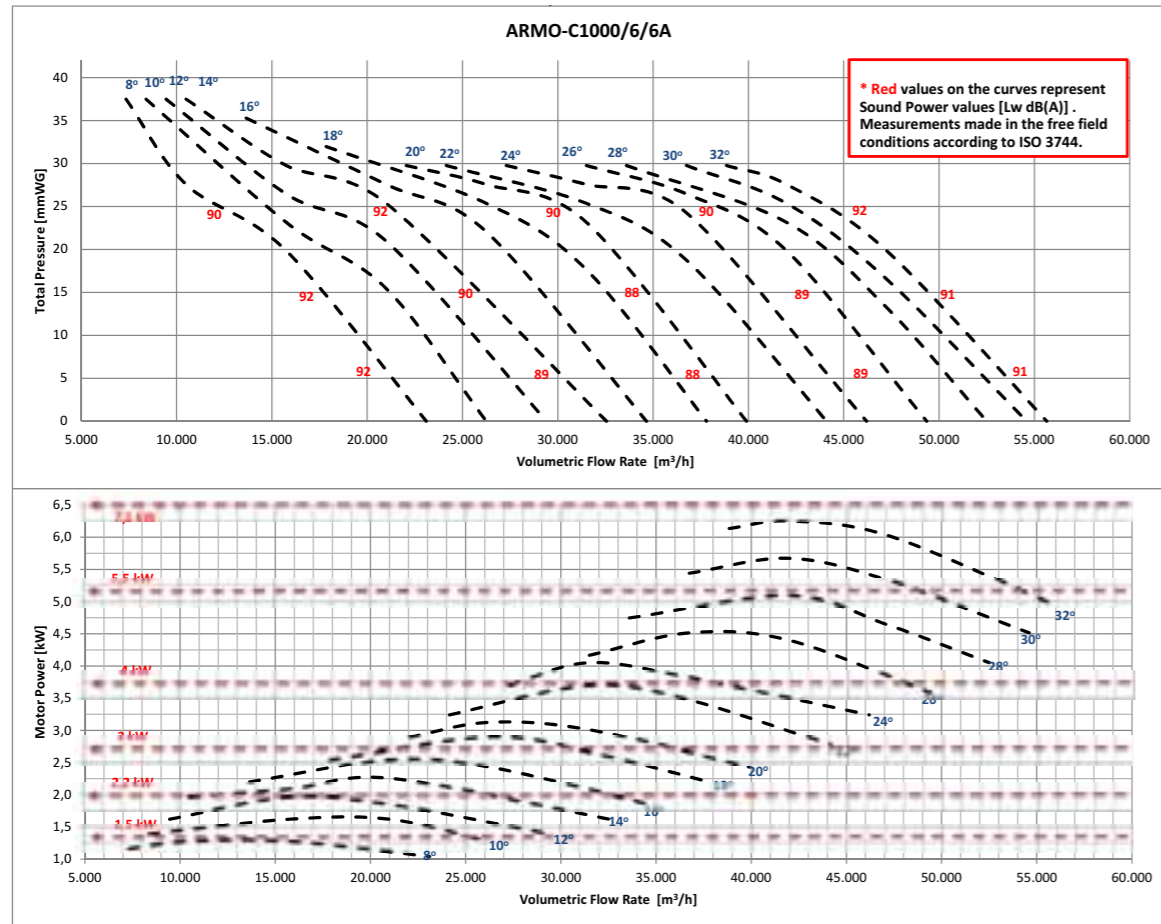

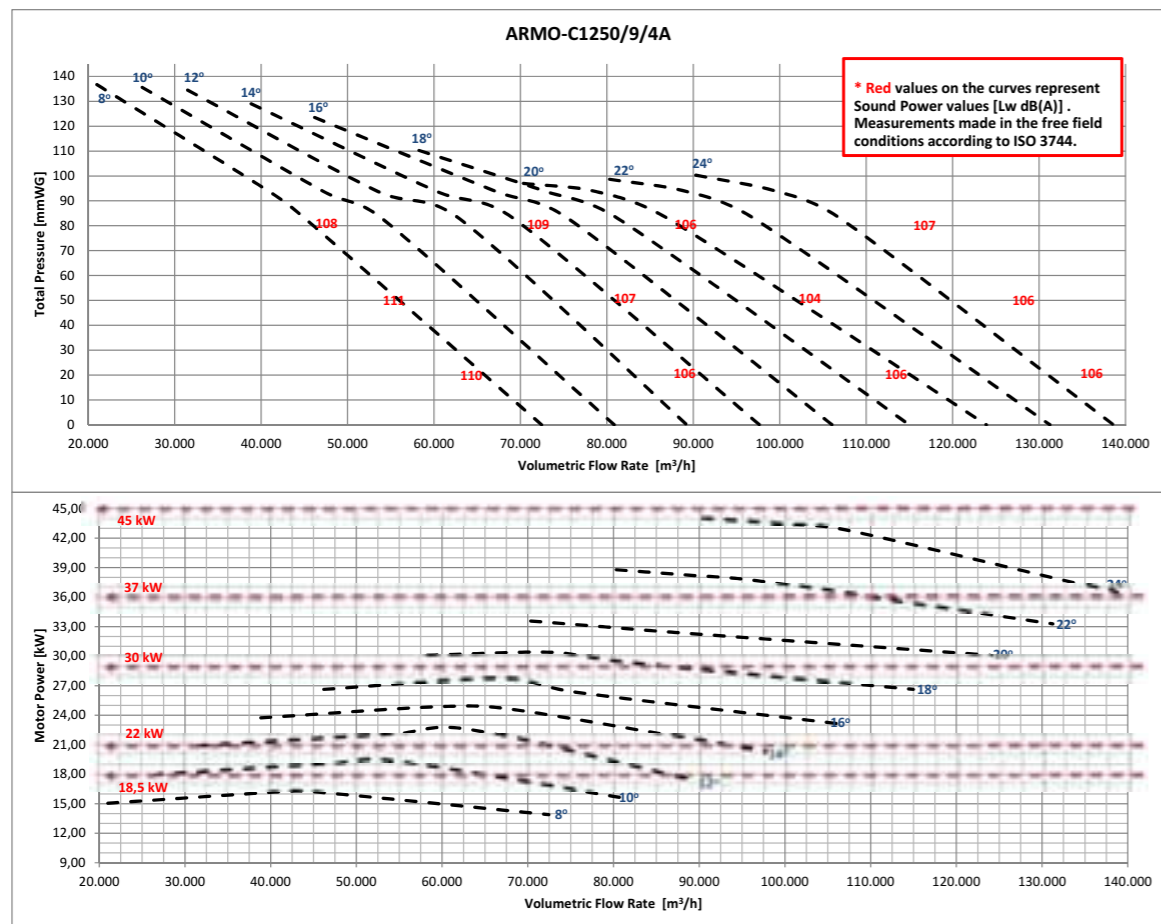
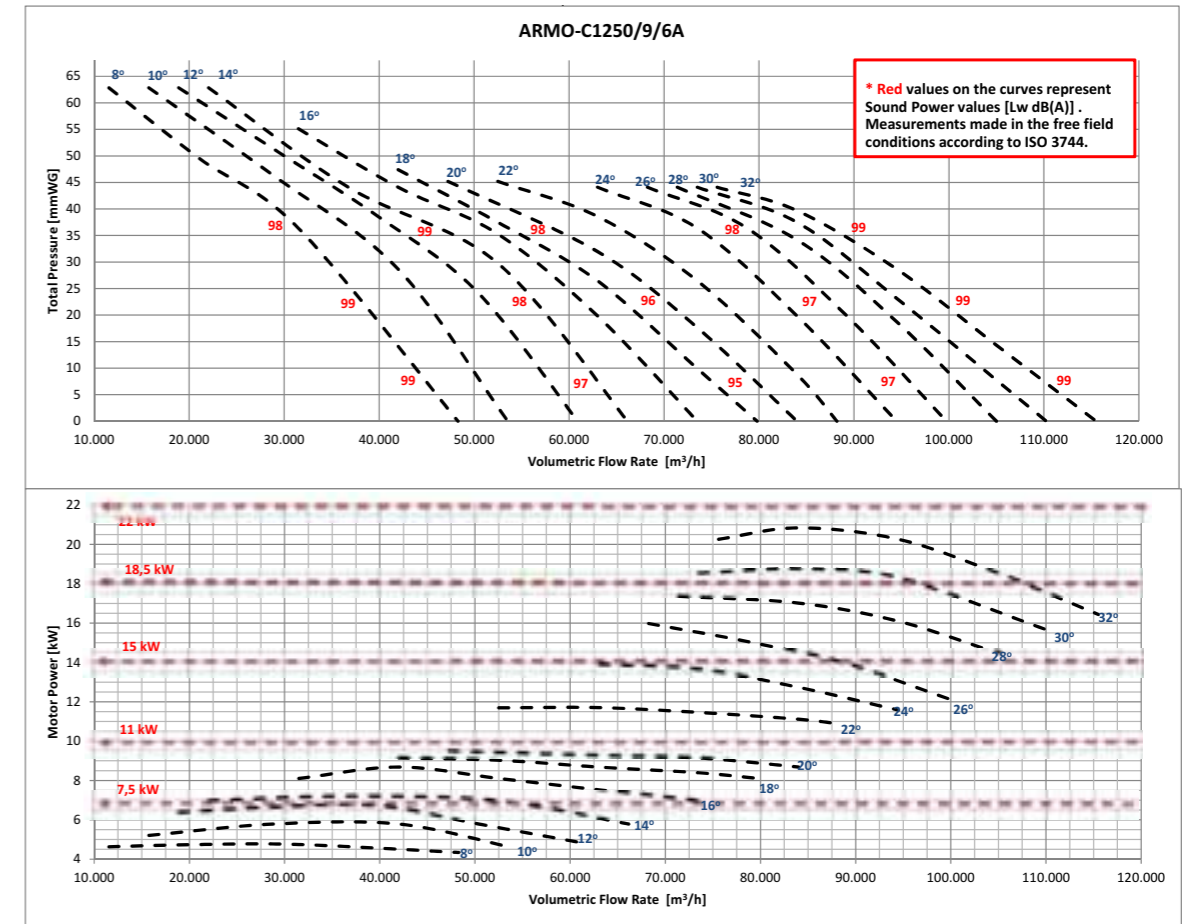
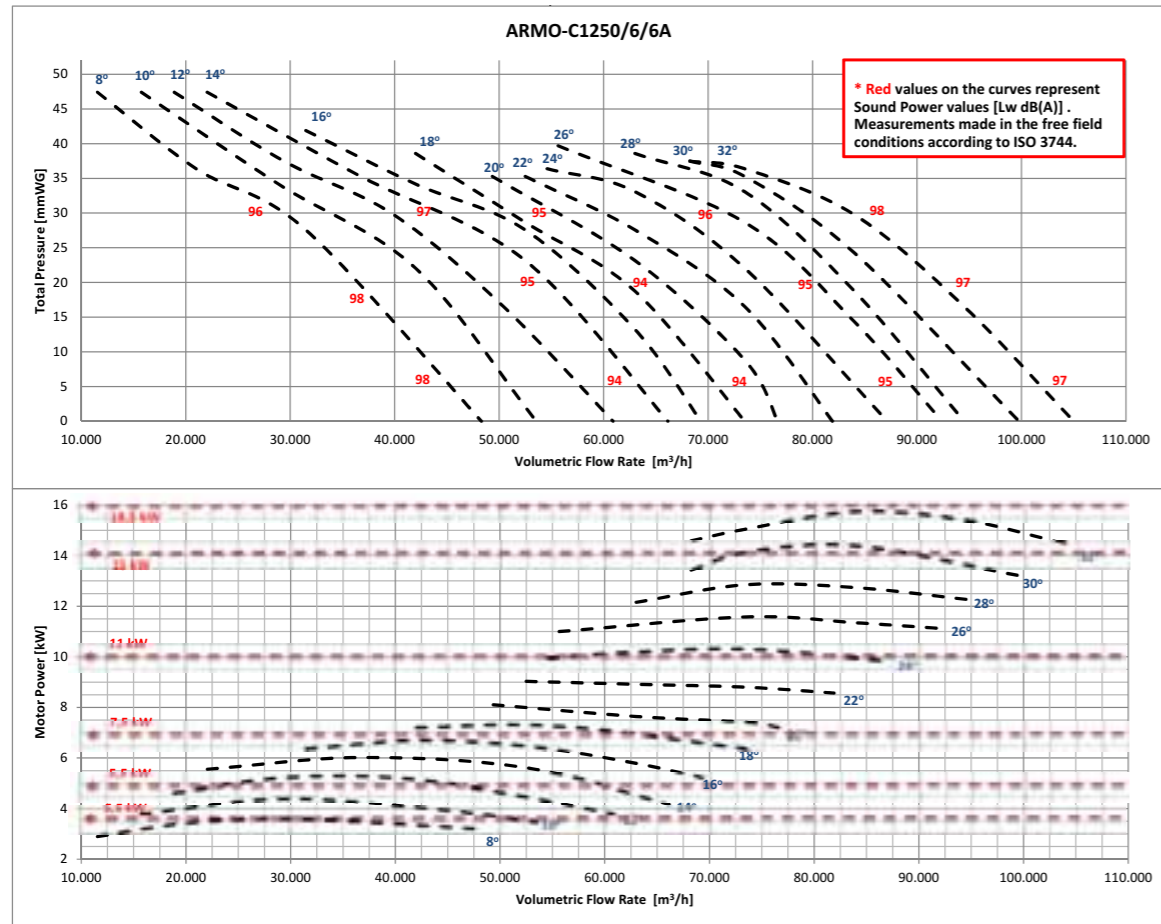



ARMO-R

PRESSURATION FANS / Roof

Axial roof fans are used in pressurization fan, fresh air fan and smoke exhaust fan applications. The enclosure is fire resistant and designed according to the noise standard. Smoke evacuation fans are fire resistant.

General Features

- It has EN 12101-3 and Ce certificates.
- 2 hours continuous operation at 400 C and 300 C.
- There is a wide product range from 400 mm to 1250 mm.

Rotor Features

- Fire resistant aluminum alloy casting blades and fan hub.
- Has the ability to work one-way and two-way. The blades are specially designed according to each direction type.
- There is no aerodynamic loss in the case of reversible wing type operation.
- Wings are airfoil and provide high aerodynamic performance in both unidirectional and bidirectional vanes.
- Wing angles are adjustable. In this way, smoke discharge fans can be demanded at different flow rates and pressures.
- The fan part of

the fan is dynamically balanced according to ISO 1940 and there is no eccentricity during the operation of the fan.

Body Features

- Fan body is steel sheet. Body is hot dip galvanized and corrosion resistant.
- It has short type body and long type body types.

Motor Features

- Offers 2.4 and 6-pole motors
- The motors are IP 55 class and Class-H insulated.
- All electric motor models are approved for continuous operation (S1) and Emergency operation (S2).

Ease of Maintenance

A maintenance cover is provided to ensure easy maintenance.

Usage Areas

Roof type Axial fans are used in pressurization fan, fresh air fan and smoke exhaust fan applications.

Technical Drawing and Tables

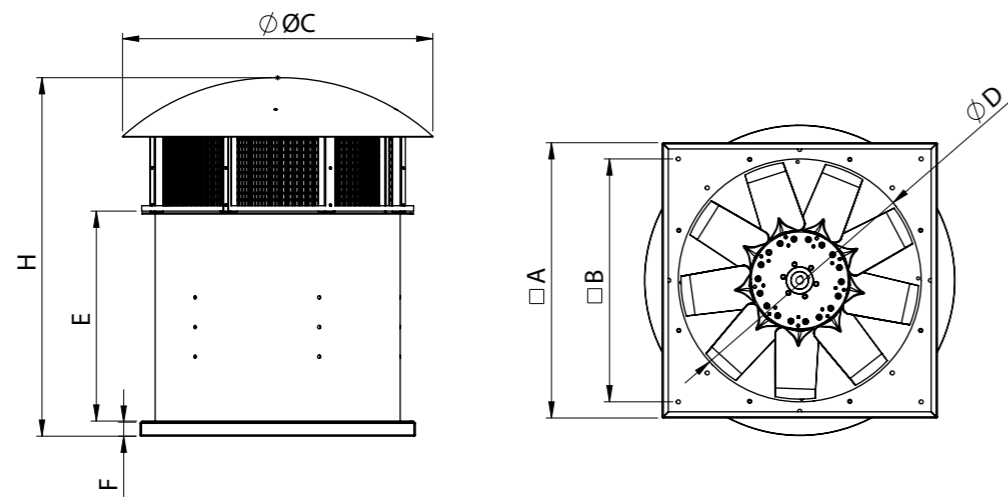

TYPE	A	B	C	D	E	H	F
ARMO-R 400	600	495	702	400	474	880	50
ARMO-R 450	650	545	702	450	474	880	50
ARMO-R 500	650	545	842	500	580	1030	50
ARMO-R 560	685	605	842	560	580	1030	50
ARMO-R 630	780	637	1130	630	600	1160	50
ARMO-R 710	830	710	1130	800	700	1300	50
ARMO-R 800	920	800	1130	800	700	1300	50
ARMO-R 900	1020	900	1130	900	775	1375	50
ARMO-R 1000	1130	1030	1430	1000	850	1450	50
ARMO-R 1250	1430	1350	1430	1250	950	1550	50

Dimensions are in (mm)



2 POLE TYPE	SPEED	DIAMETER	POWER	CURRENT	AIR FLOW	WING ANGLE
	r.p.m	mm	kW	230V - 400V	m ³ /h	
ARMO-R / 400-6 / 0,75 - 2A	2900	400	0,75	1,6	5250	16°
ARMO-R / 400-6 / 1,1 - 2A	2900	400	1,1	2,3	6904	22°
ARMO-R / 400-6 / 1,5 - 2A	2900	400	1,5	3,4	8978	30°
ARMO-R / 400-6 / 2,2 - 2A	2900	400	2,2	4,48	9975	34°
ARMO-R / 450-6 / 1,1 - 2A	2900	450	1,1	2,3	6248	10°
ARMO-R / 450-6 / 1,5 - 2A	2900	450	1,5	3,4	8610	16°
ARMO-R / 450-6 / 2,2 - 2A	2900	450	2,2	4,48	11970	24°
ARMO-R / 450-6 / 3 - 2A	2900	450	3	6	13545	28°
ARMO-R / 500-6 / 2,2 - 2A	2900	500	2,2	4,48	11000	14°
ARMO-R / 500-6 / 3 - 2A	2900	500	3	6	14595	20°
ARMO-R / 500-6 / 4 - 2A	2900	500	4	7,4	17325	26°
ARMO-R / 500-6 / 5,5 - 2A	2900	500	5,5	11	18375	28°
ARMO-R / 560-6 / 4 - 2A	2900	560	4	7,4	17850	14°
ARMO-R / 560-6 / 5,5 - 2A	2900	560	5,5	11	22313	20°
ARMO-R / 560-6 / 7,5 - 2A	2800	560	7,5	13,6	25725	24°
ARMO-R / 630-6 / 5,5 - 2A	2900	630	5,5	11	20475	10°
ARMO-R / 630-6 / 7,5 - 2A	2800	630	7,5	13,6	27300	16°

4 POLE TYPE	SPEED	DIAMETER	POWER	CURRENT	AIR FLOW	WING ANGLE
	r.p.m	mm	kW	230V - 400V	m ³ /h	
ARMO-R / 500-6 / 0,55- 4A	1415	500	0,55	1,6	8715	26
ARMO-R / 500-6 / 0,75- 4A	1350	500	0,75	2,1	10290	32
ARMO-R / 500-6 / 1,1- 4A	1400	500	1,1	2,6	12600	38
ARMO-R / 560-6 / 0,55- 4A	1415	560	0,55	1,6	9870	16
ARMO-R / 560-6 / 0,75- 4A	1350	560	0,75	2,1	12075	22
ARMO-R / 560-6 / 1,1- 4A	1400	560	1,1	2,6	13860	26
ARMO-R / 560-6 / 1,5- 4A	1405	560	1,5	3,5	15750	32
ARMO-R / 560-6 / 2,2- 4A	1410	560	2,2	5	17850	38
ARMO-R / 630-6 / 0,75- 4A	1350	630	0,75	2,1	10605	10
ARMO-R / 630-6 / 1,1- 4A	1400	630	1,1	2,6	16275	20
ARMO-R / 630-6 / 1,5- 4A	1405	630	1,5	3,5	18375	24
ARMO-R / 630-6 / 2,2- 4A	1410	630	2,2	5	21525	30
ARMO-R / 630-6 / 3- 4A	1410	630	3	6,6	24150	36
ARMO-R / 630-6 / 4- 4A	1500	630	4	8,2	25200	38
ARMO-R / 710-3 / 0,75- 4A	1350	710	0,75	2,1	14175	10
ARMO-R / 710-3 / 1,1- 4A	1400	710	1,1	2,6	18375	16
ARMO-R / 710-3 / 1,5- 4A	1405	710	1,5	3,5	21000	20
ARMO-R / 710-3 / 2,2- 4A	1410	710	2,2	5	24413	26
ARMO-R / 710-3 / 3- 4A	1410	710	3	6,6	27825	32
ARMO-R / 710-6 / 1,1- 4A	1400	710	1,1	2,6	16275	12
ARMO-R / 710-6 / 1,5- 4A	1405	710	1,5	3,5	20475	18
ARMO-R / 710-6 / 2,2- 4A	1410	710	2,2	5	23625	22
ARMO-R / 710-6 / 3- 4A	1410	710	3	6,6	28350	28
ARMO-R / 710-6 / 4- 4A	1415	710	4	8,2	31500	32
ARMO-R / 800-6 / 2,2- 4A	1410	800	2,2	5	24150	14
ARMO-R / 800-6 / 3- 4A	1410	800	3	6,6	30450	20
ARMO-R / 800-6 / 4- 4A	1415	800	4	8,2	32550	22
ARMO-R / 800-6 / 5,5- 4A	1430	800	5,5	11,2	38850	28
ARMO-R / 800-6 / 7,5- 4A	1440	800	7,5	15,4	42525	32
ARMO-R / 800-9 / 2,2- 4A	1410	800	2,2	5	16275	10
ARMO-R / 800-9 / 3- 4A	1410	800	3	6,6	21525	14
ARMO-R / 800-9 / 4- 4A	1415	800	4	8,2	29400	20
ARMO-R / 800-9 / 5,5- 4A	1430	800	5,5	11,2	36488	26
ARMO-R / 800-9 / 7,5- 4A	1440	800	7,5	15,4	40950	30
ARMO-R / 800-9 / 11- 4A	1450	800	11	21	43050	32
ARMO-R / 900-6 / 4- 4A	1415	900	4	8,2	31500	12
ARMO-R / 900-6 / 5,5- 4A	1430	900	5,5	11,2	38850	16
ARMO-R / 900-6 / 7,5- 4A	1440	900	7,5	15,4	47775	22
ARMO-R / 900-6 / 11- 4A	1450	900	11	21	56700	28
ARMO-R / 900-6 / 15- 4A	1450	900	15	29,3	60900	32
ARMO-R / 900-9 / 4- 4A	1415	900	4	8,2	26775	10
ARMO-R / 900-9 / 5,5- 4A	1430	900	5,5	11,2	34125	14
ARMO-R / 900-9 / 7,5- 4A	1440	900	7,5	15,4	41213	18
ARMO-R / 900-9 / 11- 4A	1450	900	11	21	54600	26
ARMO-R / 900-9 / 15- 4A	1450	900	15	29,3	63525	32
ARMO-R / 1000-6 / 5,5- 4A	1430	1000	5,5	11,2	38850	12
ARMO-R / 1000-6 / 7,5- 4A	1440	1000	7,5	15,4	47775	18
ARMO-R / 1000-6 / 11- 4A	1450	1000	11	21	56700	22
ARMO-R / 1000-6 / 15- 4A	1450	1000	15	29,3	60900	28
ARMO-R / 1000-6 / 18,5- 4A	1455	1000	18,5	34,5	56700	32
ARMO-R / 1000-9 / 7,5- 4A	1440	1000	7,5	15,4	43050	12
ARMO-R / 1000-9 / 11- 4A	1450	1000	11	21	55650	18
ARMO-R / 1000-9 / 15- 4A	1450	1000	15	29,3	69300	24
ARMO-R / 1000-9 / 18,5- 4A	1455	1000	18,5	34,5	77700	28
ARMO-R / 1000-9 / 22- 4A	1460	1000	22	42,5	81900	30
ARMO-R / 1000-9 / 30- 4A	1460	1000	30	55	86100	32
ARMO-R / 1250-6 / 15- 4A	1450	1250	15	29,3	90300	12
ARMO-R / 1250-6 / 18,5- 4A	1455	1250	18,5	34,5	103950	16
ARMO-R / 1250-6 / 22- 4A	1460	1250	22	42,5	109725	18
ARMO-R / 1250-6 / 30- 4A	1460	1250	30	55	122850	22
ARMO-R / 1250-6 / 37- 4A	1470	1250	37	67	136500	26
ARMO-R / 1250-6 / 45- 4A	1475	1250	45	80	155400	32
ARMO-R / 1250-9 / 18,5- 4A	1455	1250	18,5	34,5	89250	12
ARMO-R / 1250-9 / 22- 4A	1460	1250	22	42,5	97650	14
ARMO-R / 1250-9 / 30- 4A	1460	1250	30	55	114975	18
ARMO-R / 1250-9 / 37- 4A	1470	1250	37	67	131250	22
ARMO-R / 1250-9 / 45- 4A	1475	1250	45	80	138600	24

6 POLE TYPE	SPEED	DIAMETER	POWER	CURRENT	AIR FLOW	WING ANGLE
	r.p.m	mm	kW	230V - 400V	m ³ /h	
ARMO-R / 500-6 / 0,37- 6A	900	500	0,37	1,1	8400	38
ARMO-R / 560-6 / 0,37- 6A	900	560	0,37	1,1	10500	32
ARMO-R / 560-6 / 0,55- 6A	930	560	0,55	1,5	11760	38
ARMO-R / 630-6 / 0,37- 6A	900	630	0,37	1,1	11576	22
ARMO-R / 630-6 / 0,55- 6A	930	630	0,55	1,5	13650	28
ARMO-R / 630-6 / 0,75- 6A	945	630	0,75	2	14963	32
ARMO-R / 630-6 / 1,1- 6A	945	630	1,1	2,9	16800	38
ARMO-R / 710-3 / 0,37- 6A	900	710	0,37	1,1	13125	18
ARMO-R / 710-3 / 0,55- 6A	930	710	0,55	1,5	16538	26
ARMO-R / 710-3 / 0,75- 6A	945	710	0,75	2	18900	32
ARMO-R / 710-6 / 1,1- 6A	945	710	1,1	2,9	11025	12
ARMO-R / 710-6 / 1,5- 6A	945	710	1,5	3,6	13000	16
ARMO-R / 710-6 / 2,2- 6A	950	710	2,2	5,4	13750	22
ARMO-R / 710-6 / 3- 6A	950	710	3	6,9	18900	28
ARMO-R / 710-6 / 4- 6A	955	710	4	9	21000	32
ARMO-R / 800-6 / 0,55- 6A	930	800	0,55		13125	10
ARMO-R / 800-6 / 1,1- 6A	945	800	1,1	2,9	22050	22
ARMO-R / 800-6 / 1,5- 6A	945	800	1,5	3,6	25200	26
ARMO-R / 800-6 / 2,2- 6A	950	800	2,2	5,4	28350	32
ARMO-R / 800-9 / 0,75- 6A	945	800	0,75	2	14700	14
ARMO-R / 800-9 / 1,1- 6A	945	800	1,1	2,9	19950	20
ARMO-R / 800-9 / 1,5- 6A	945	800	1,5	3,6	23100	24
ARMO-R / 800-9 / 2,2- 6A	950	800	2,2	5,4	27300	30
ARMO-R / 800-9 / 3- 6A	950	800	3	6,9	28350	32
ARMO-R / 900-6 / 1,1- 6A	945	900	1,1	2,9	23100	14
ARMO-R / 900-6 / 1,5- 6A	945	900	1,5	3,6	25200	16
ARMO-R / 900-6 / 2,2- 6A	950	900	2,2	5,4	31500	22
ARMO-R / 900-6 / 3- 6A	950	900	3	6,9	36750	28
ARMO-R / 900-6 / 4- 6A	955	900	4	9	40950	32
ARMO-R / 900-9 / 1,5- 6A	945	900	1,5	3,6	23100	14
ARMO-R / 900-9 / 2,2- 6A	950	900	2,2	5,4	27300	20
ARMO-R / 900-9 / 3- 6A	950	900	3	6,9	35700	24
ARMO-R / 900-9 / 4- 6A	955	900	4	9	39900	30
ARMO-R / 900-9 / 5,5- 6A	985	900	5,5	12,3	43050	32
ARMO-R / 1000-6 / 1,5- 6A	945	1000	1,5	3,6	26250	10
ARMO-R / 1000-6 / 2,2- 6A	950	1000	2,2	5,4	34650	16
ARMO-R / 1000-6 / 3- 6A	950	1000	3	6,9	44100	22
ARMO-R / 1000-6 / 4- 6A	955	1000	4	9	49350	26
ARMO-R / 1000-6 / 5,5- 6A	985	1000	5,5	12,3	55650	32
ARMO-R / 1000-9 / 2,2- 6A	950	1000	2,2	5,4	32550	14
ARMO-R / 1000-9 / 3- 6A	950	1000	3	6,9	39900	20
ARMO-R / 1000-9 / 4- 6A	955	1000	4	9	43050	22
ARMO-R / 1000-9 / 5,5- 6A	985	1000	5,5	12,3	52500	28
ARMO-R / 1000-9 / 7,5- 6A	960	1000	7,5	15	57750	32
ARMO-R / 1250-6 / 4- 6A	955	1250	4	9	60900	12
ARMO-R / 1250-6 / 5,5- 6A	985	1250	5,5	12,3	63300	16
ARMO-R / 1250-6 / 7,5- 6A	960	1250	7,5	15	76650	20
ARMO-R / 1250-6 / 11- 6A	960	1250	11	22	92400	26
ARMO-R / 1250-6 / 15- 6A	965	1250	15	29	105000	32
ARMO-R / 1250-9 / 7,5- 6A	960	1250	7,5	15	73500	16
ARMO-R / 1250-9 / 11- 6A	960	1250	11	22	88200	22
ARMO-R / 1250-9 / 15- 6A	965	1250	15	29	105000	28
ARMO-R / 1250-9 / 18,5- 6A	970	1250	18,5	36,5	115500	32

Accessories



BSC-F

BSST

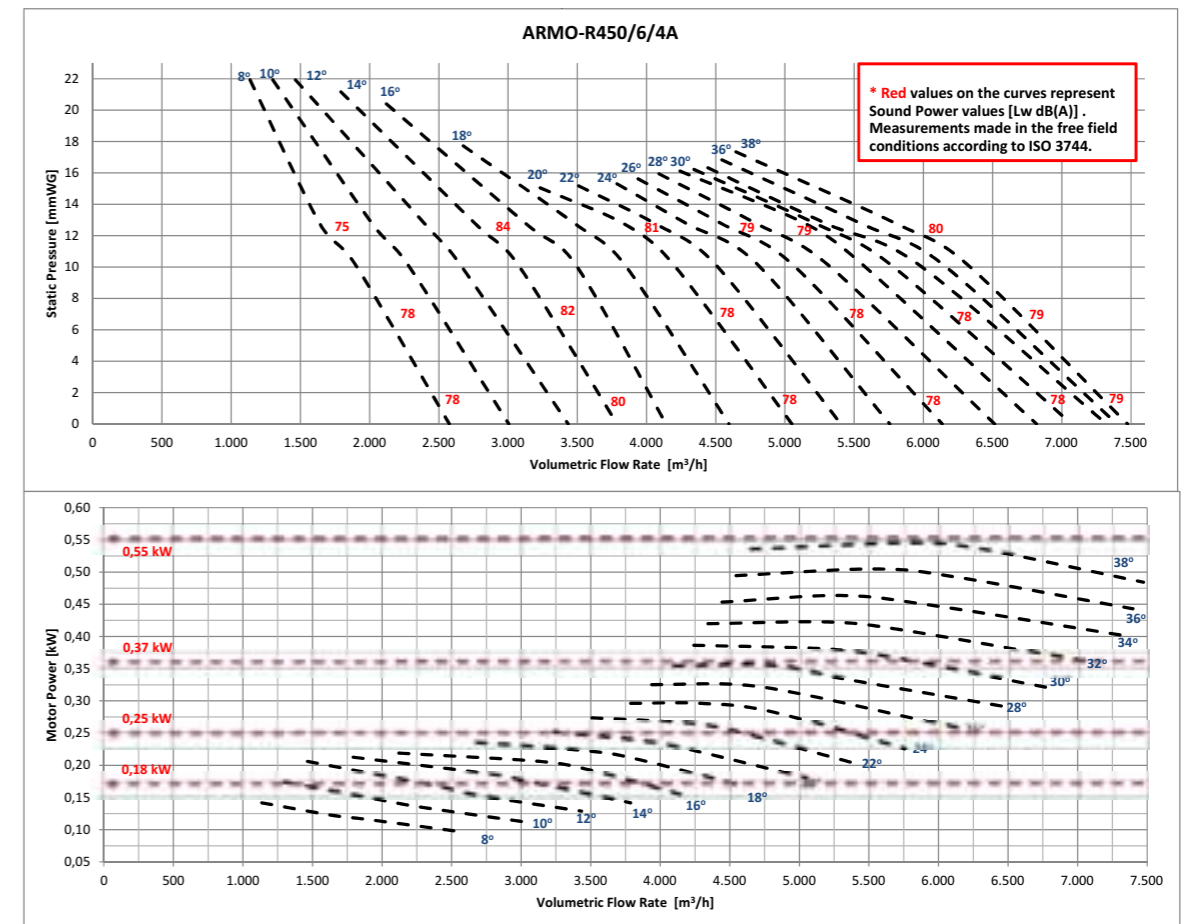
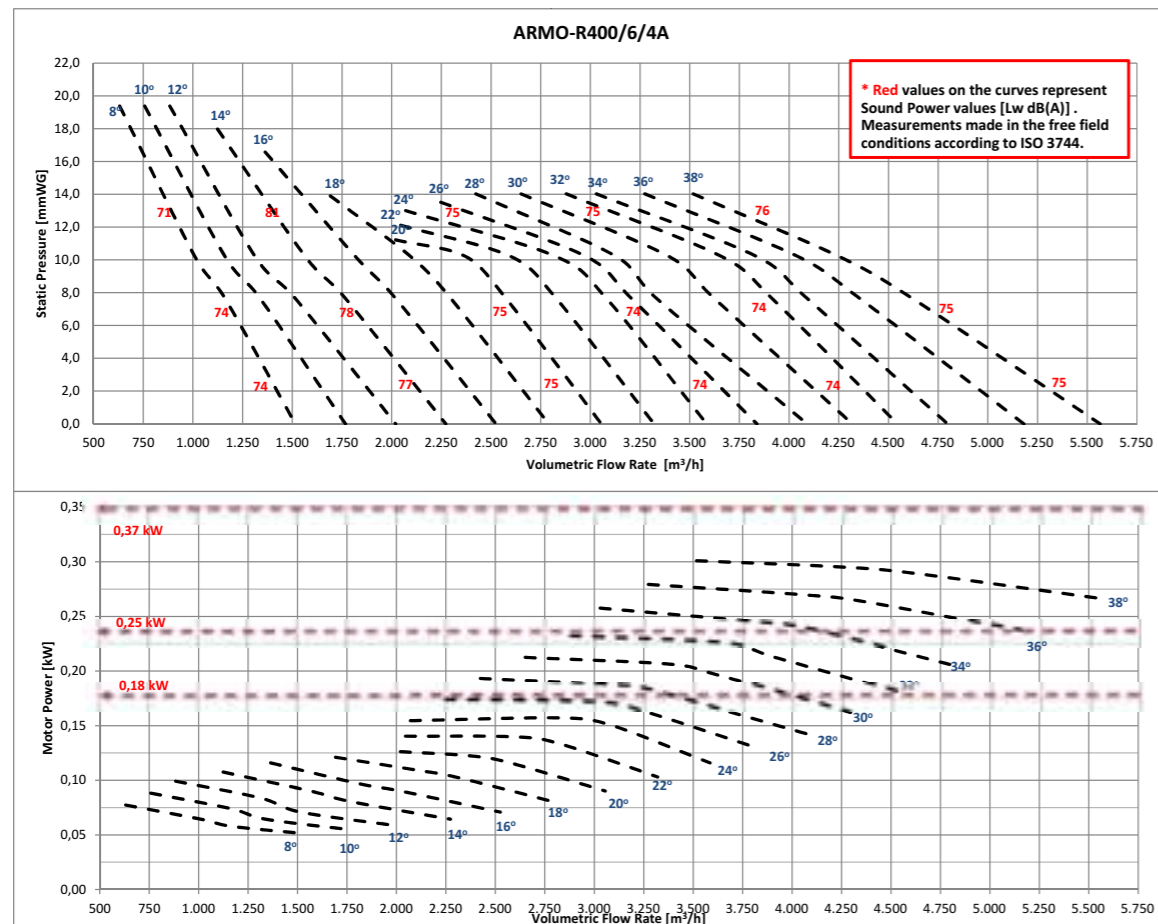
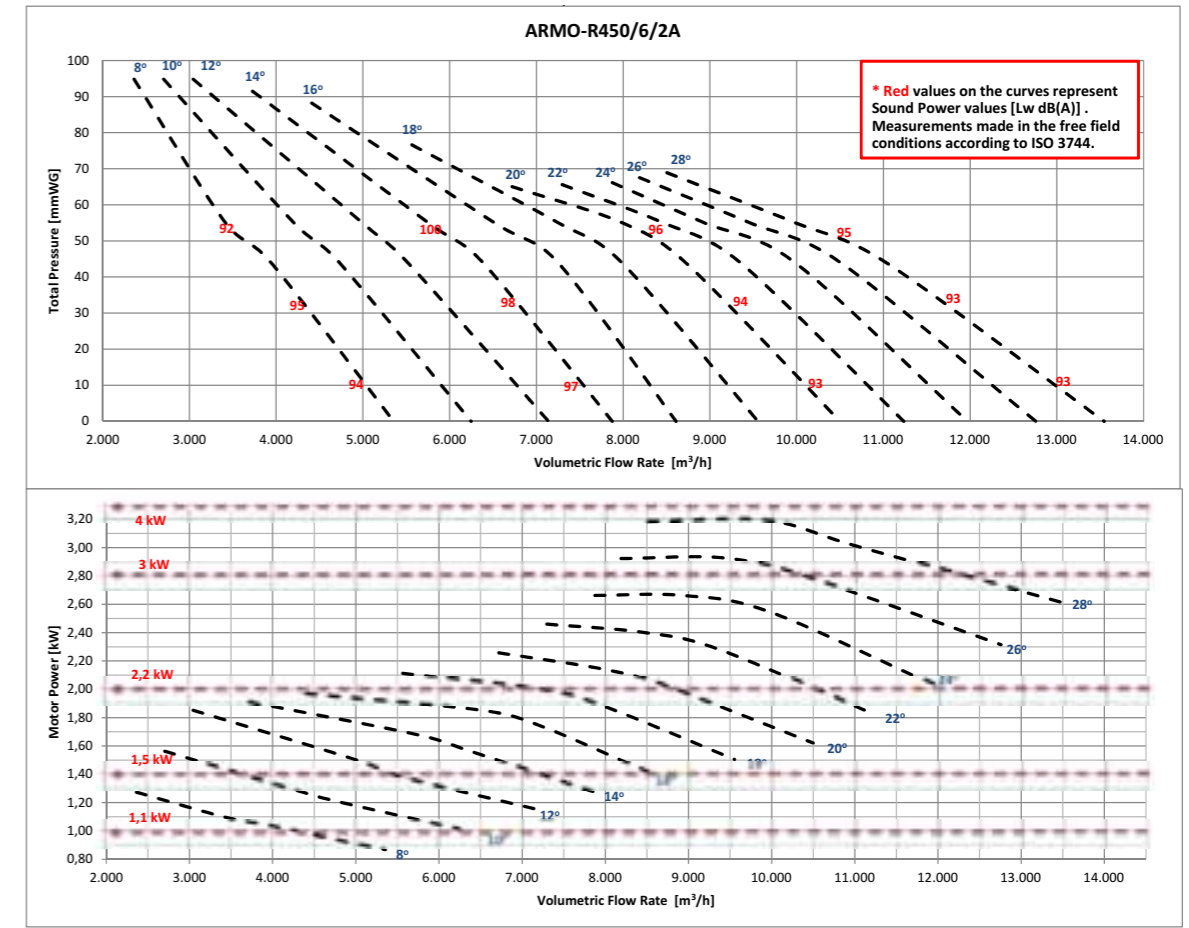
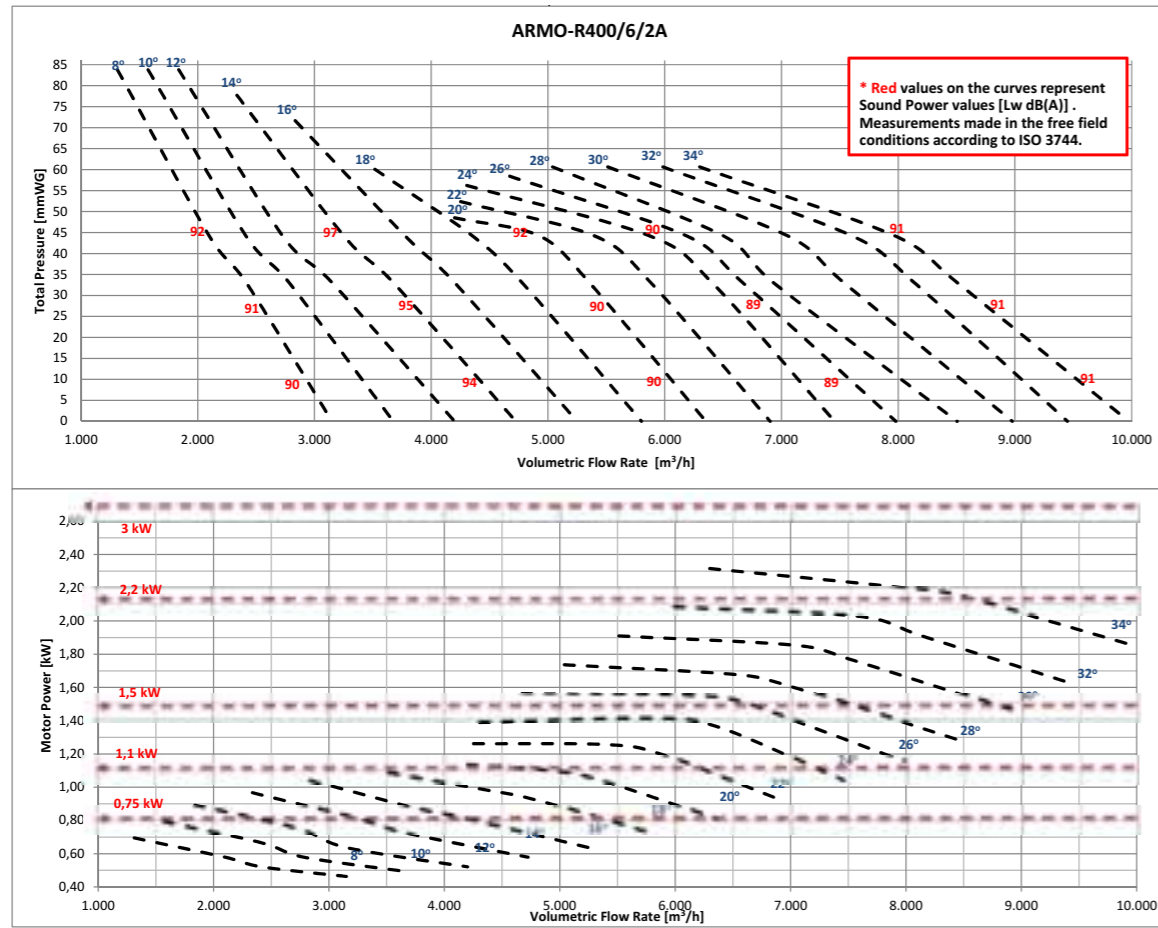

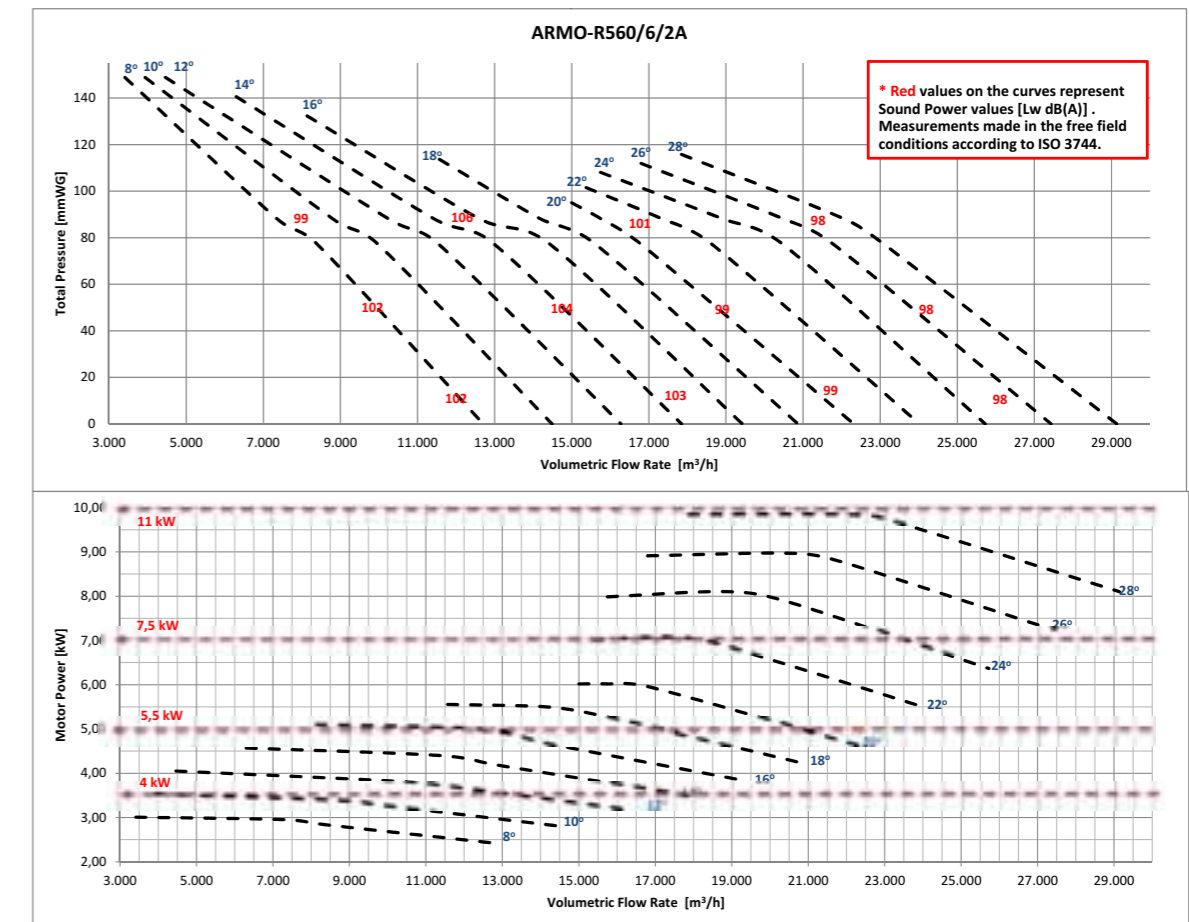
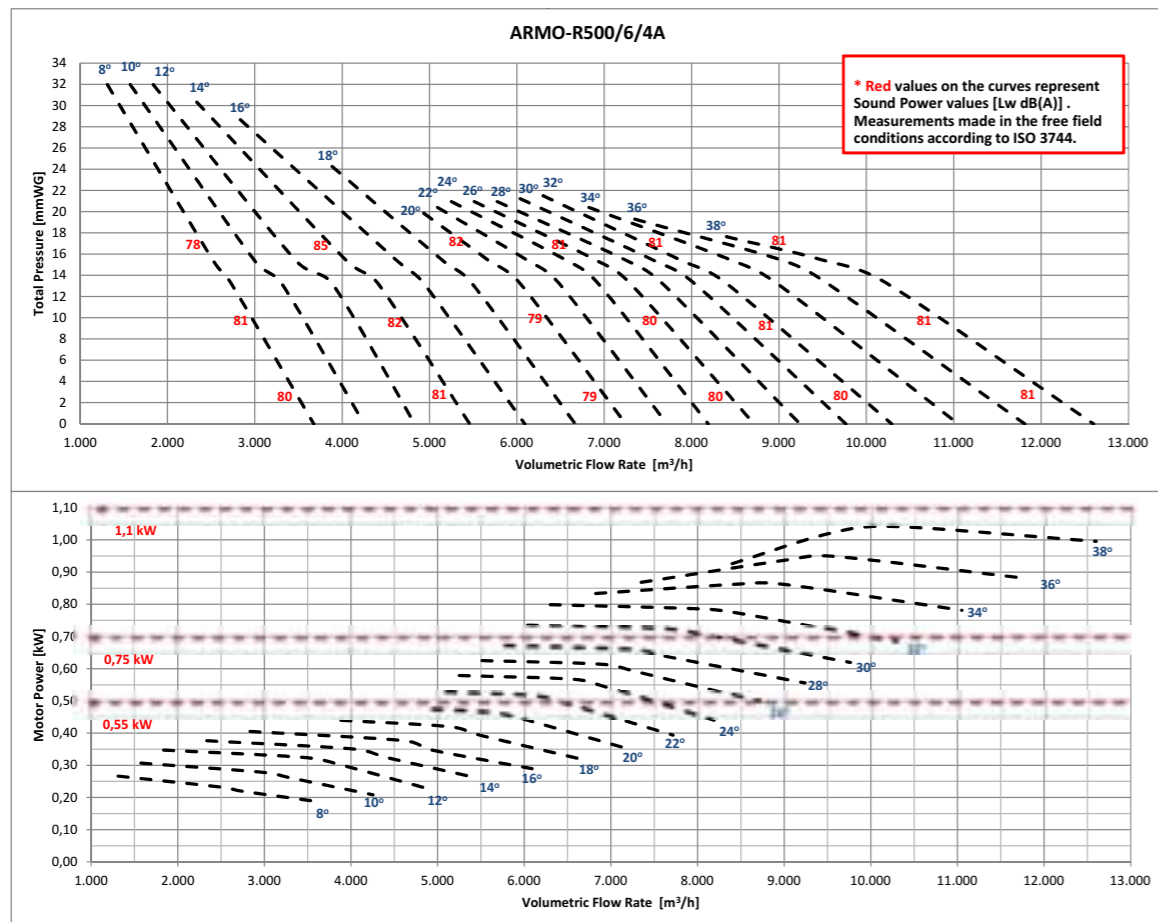
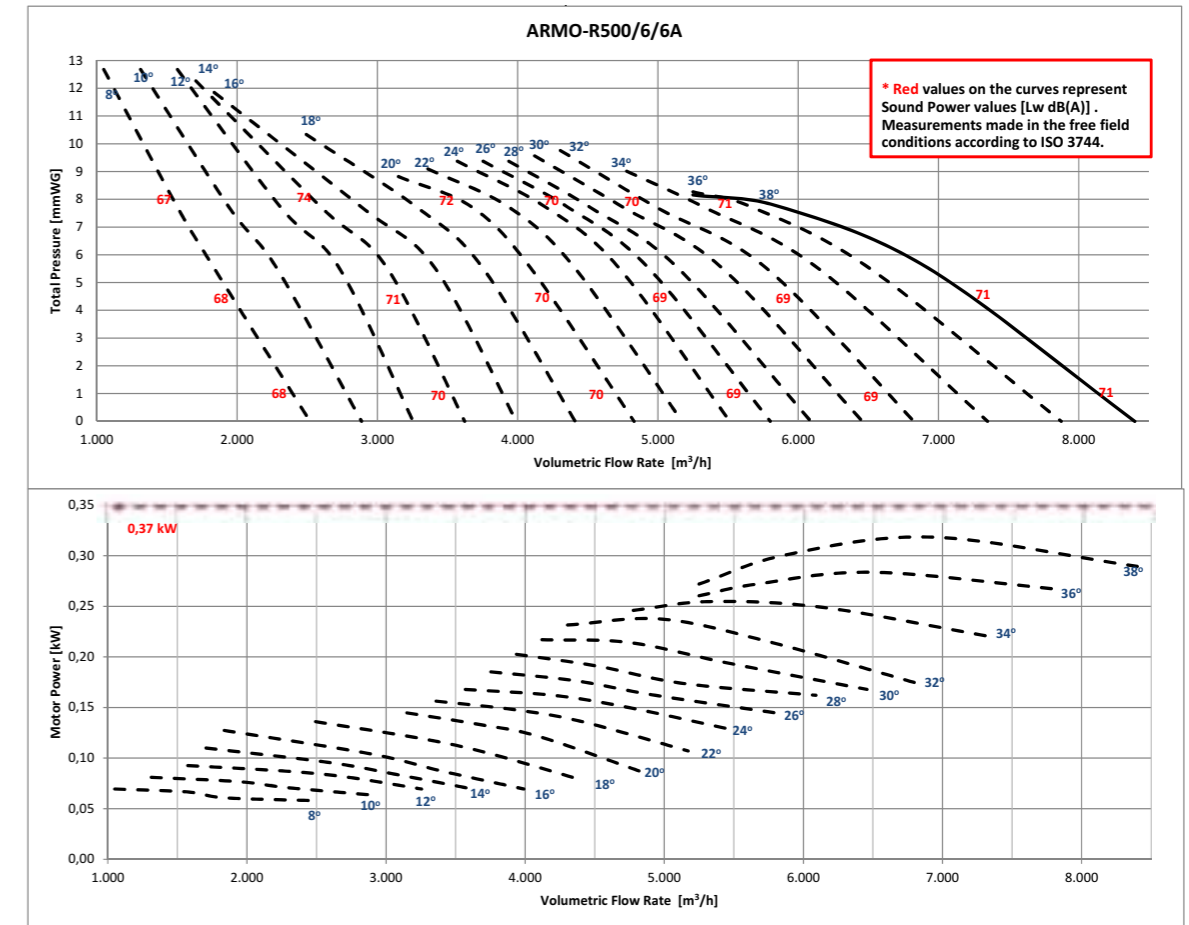
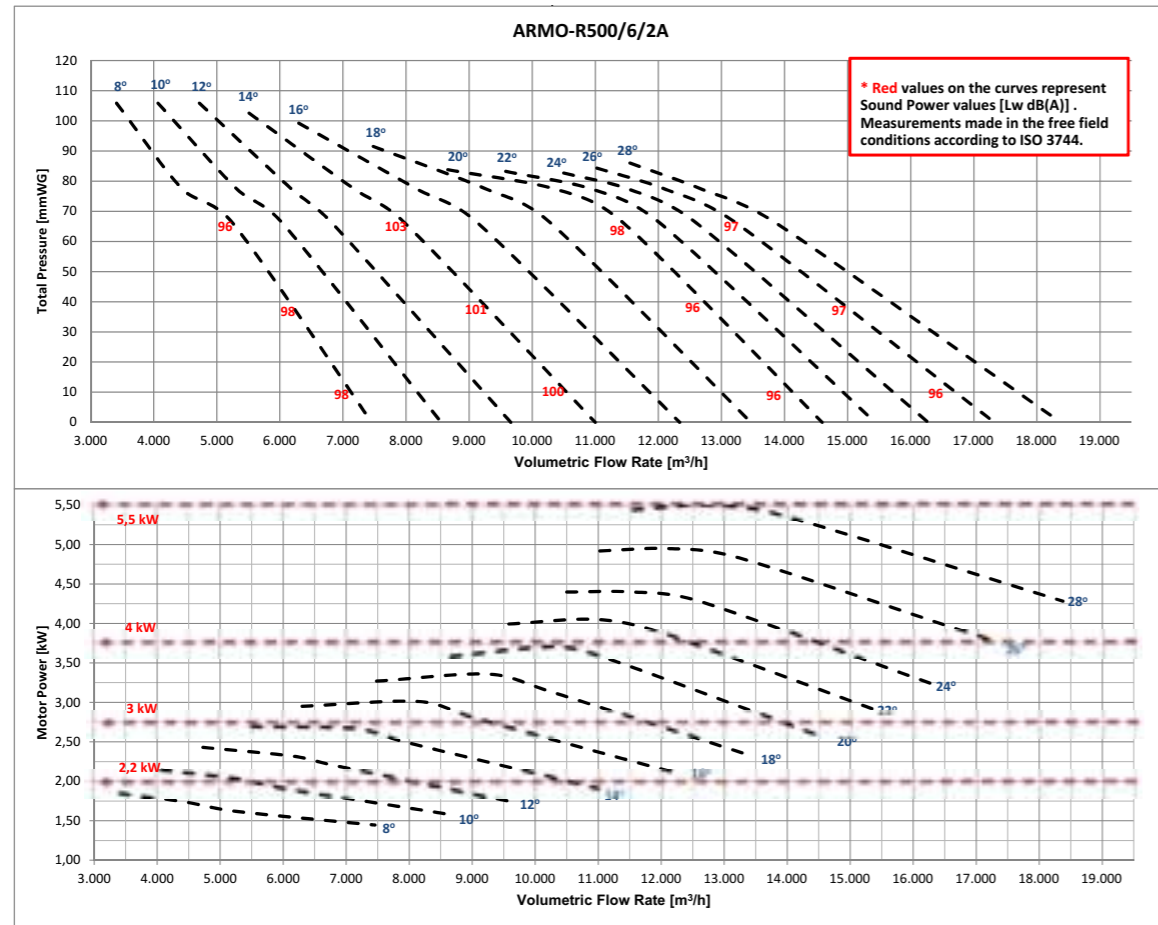

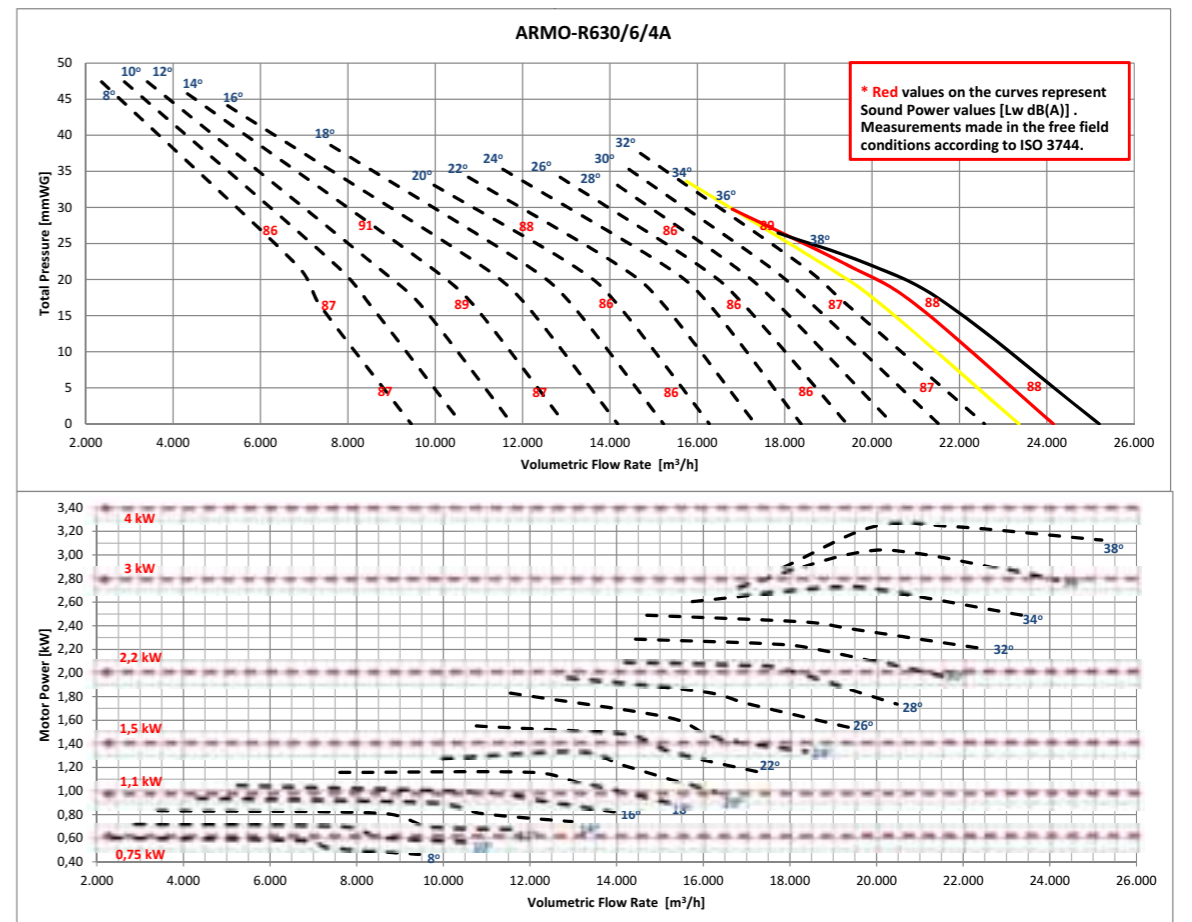
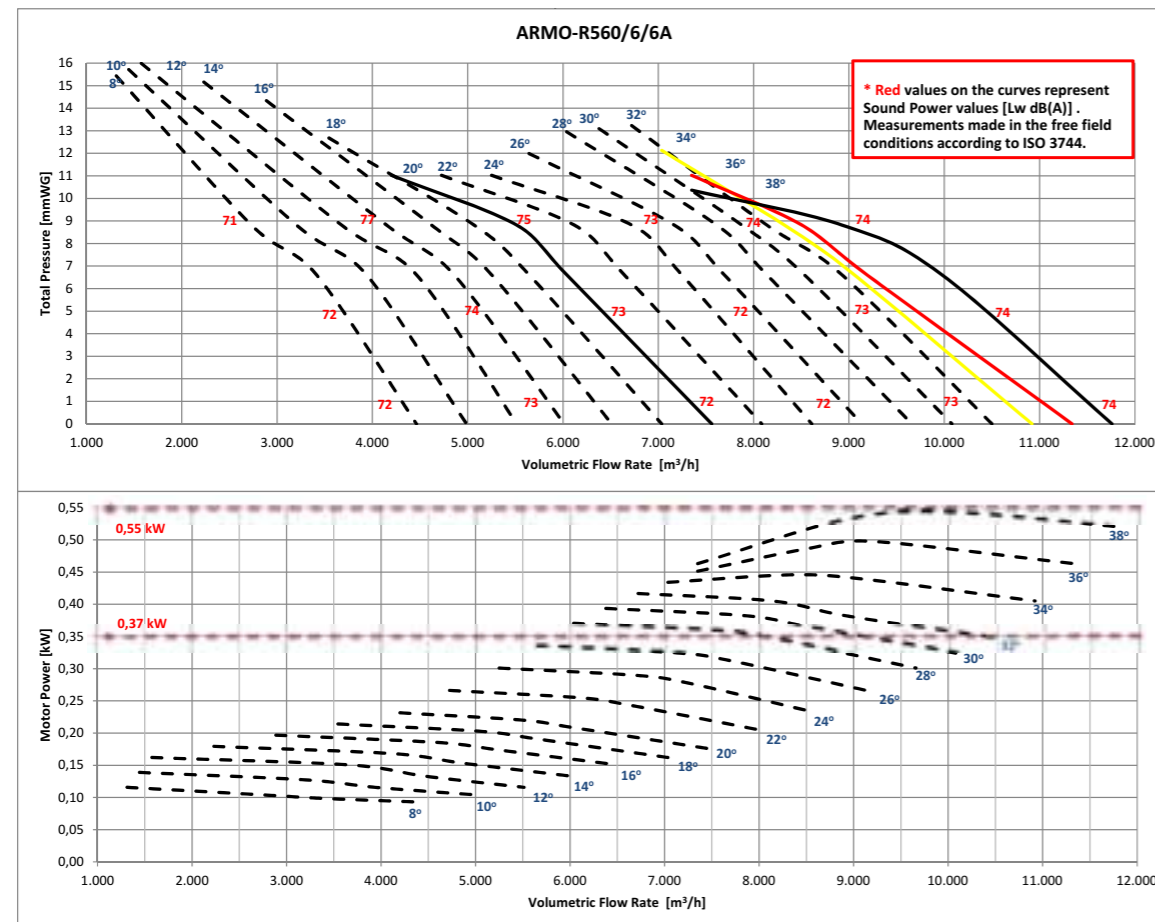
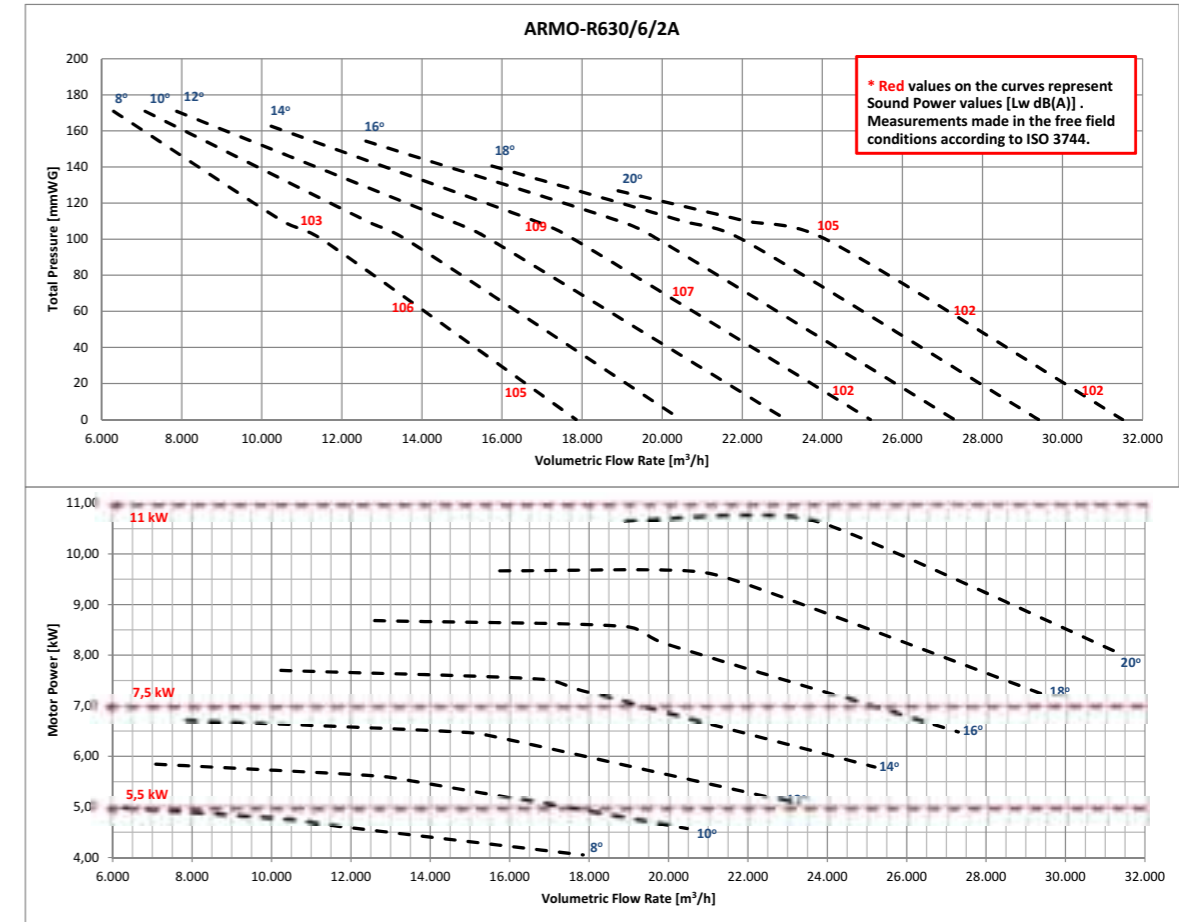
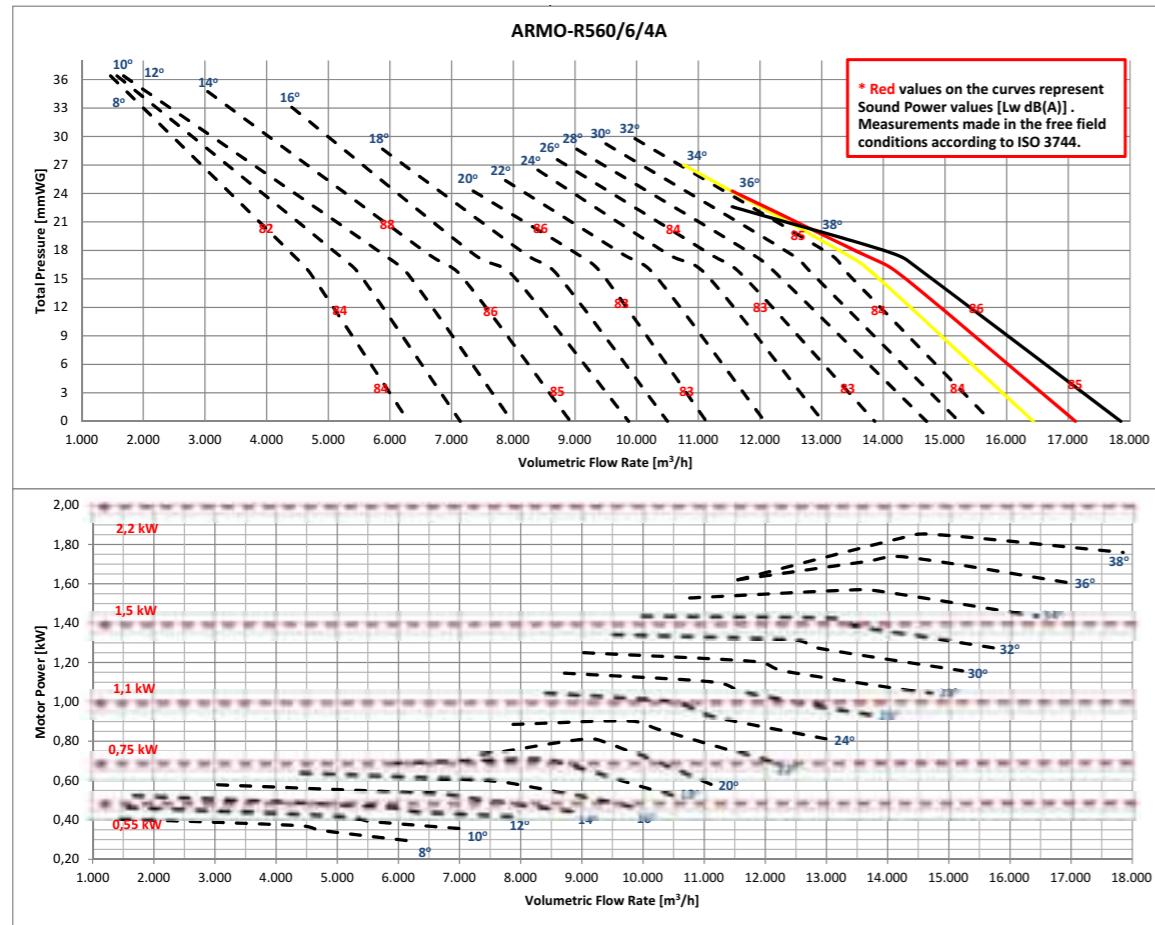

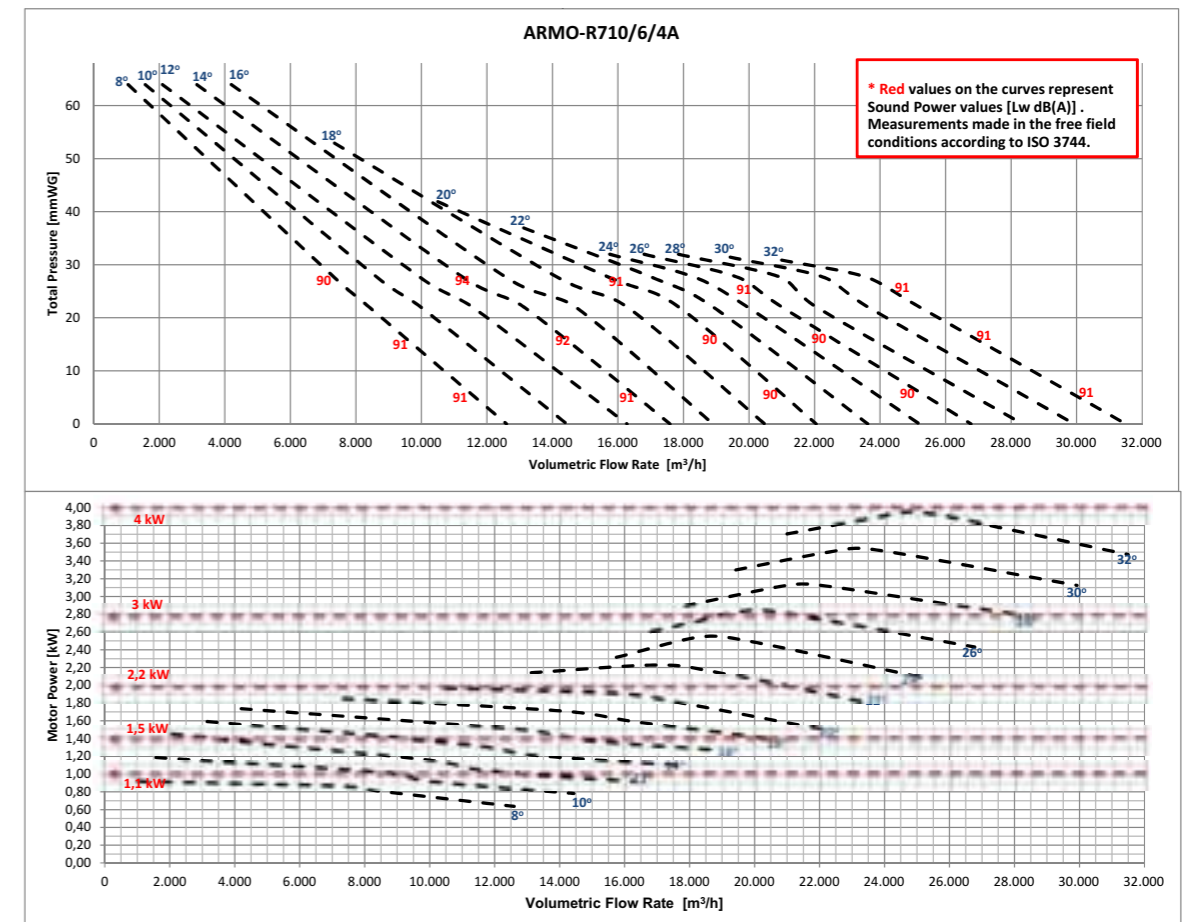
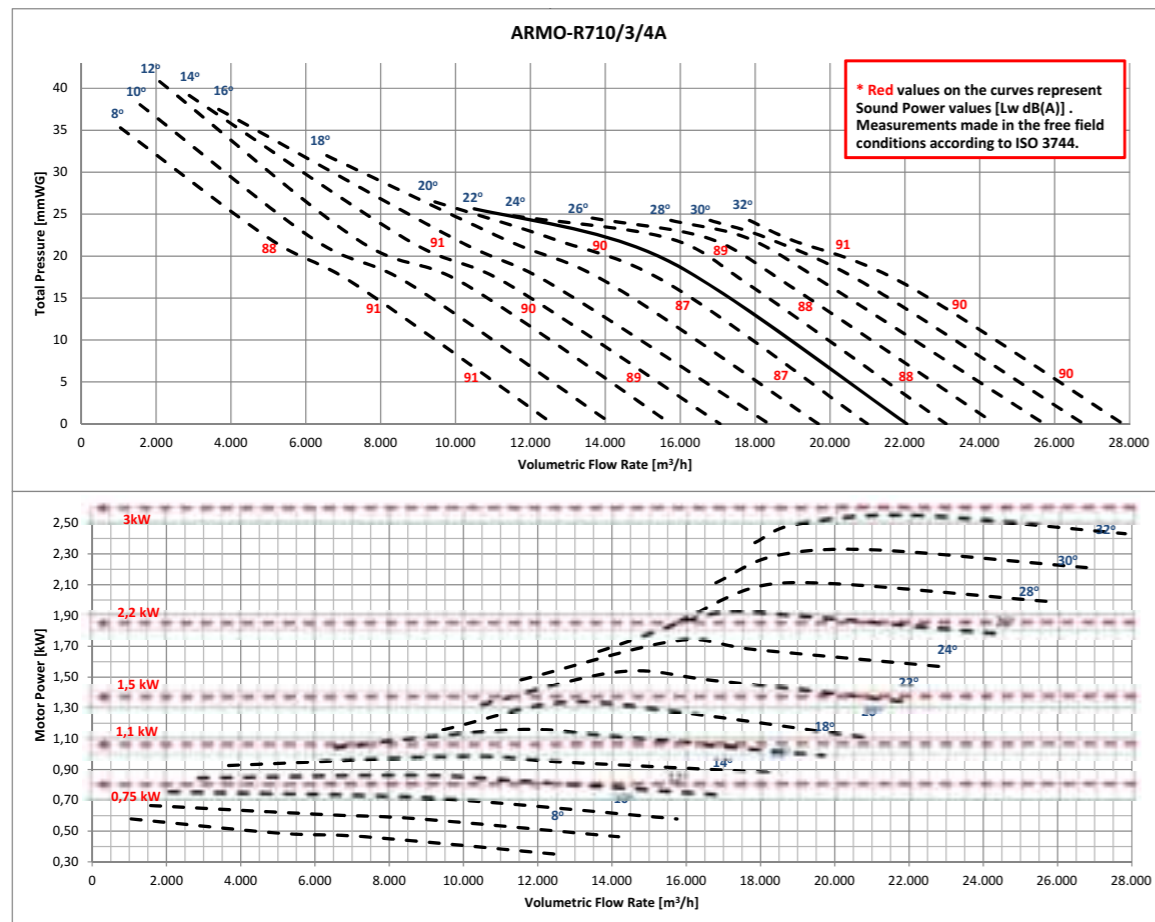
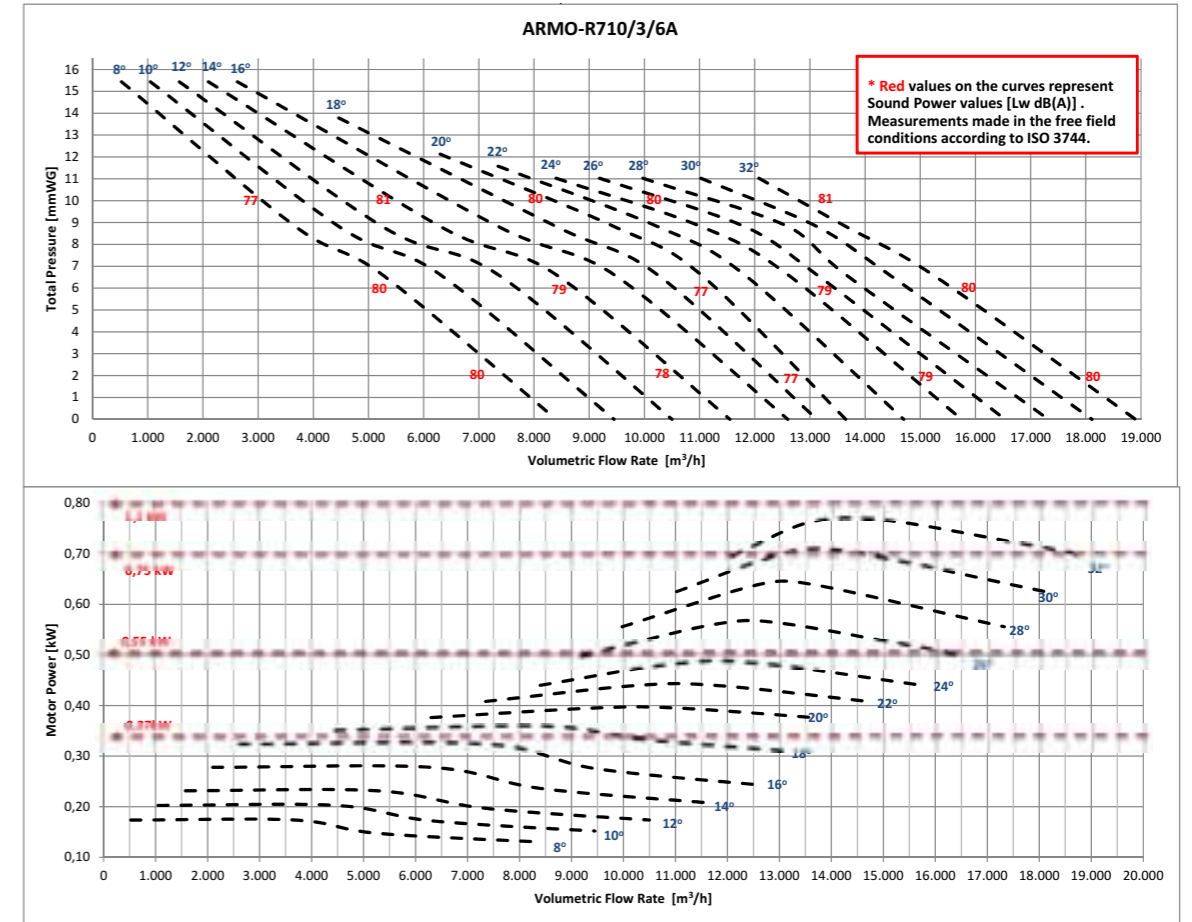
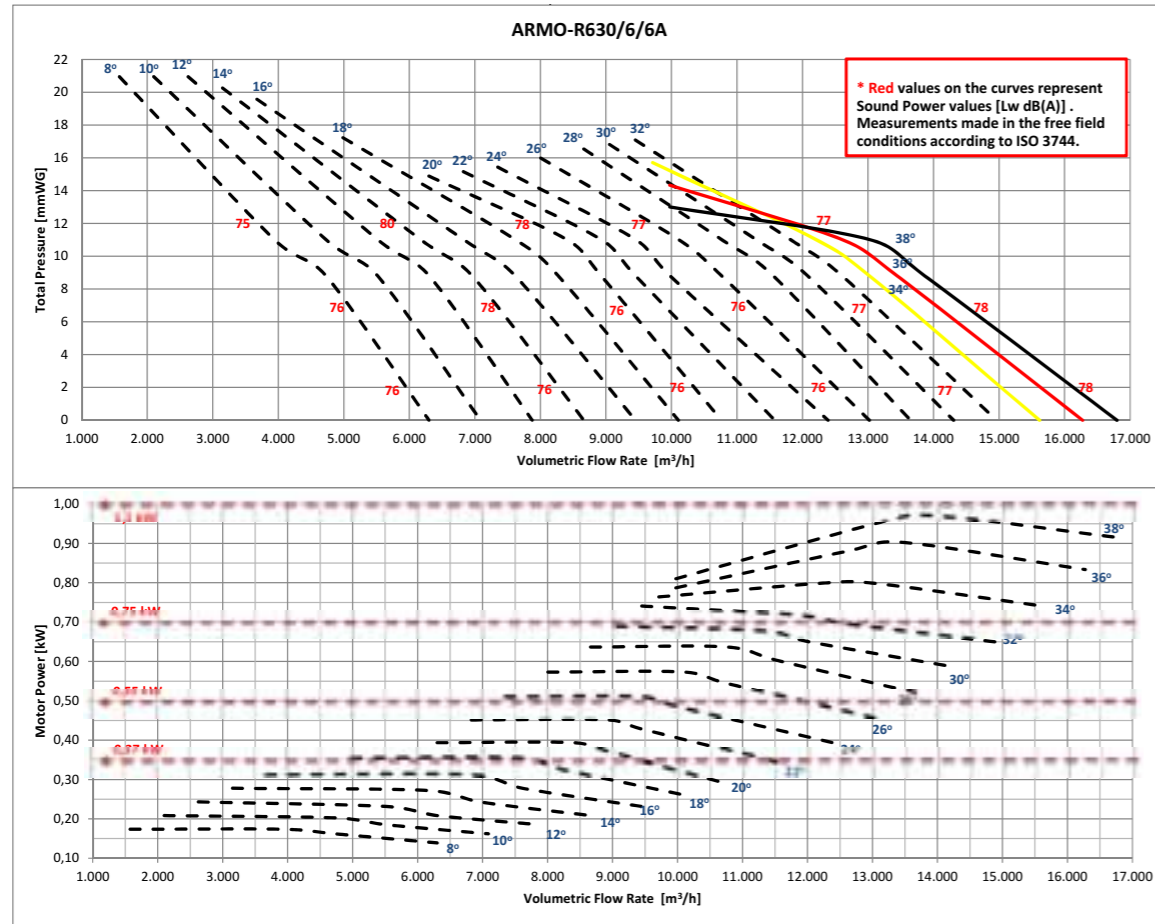

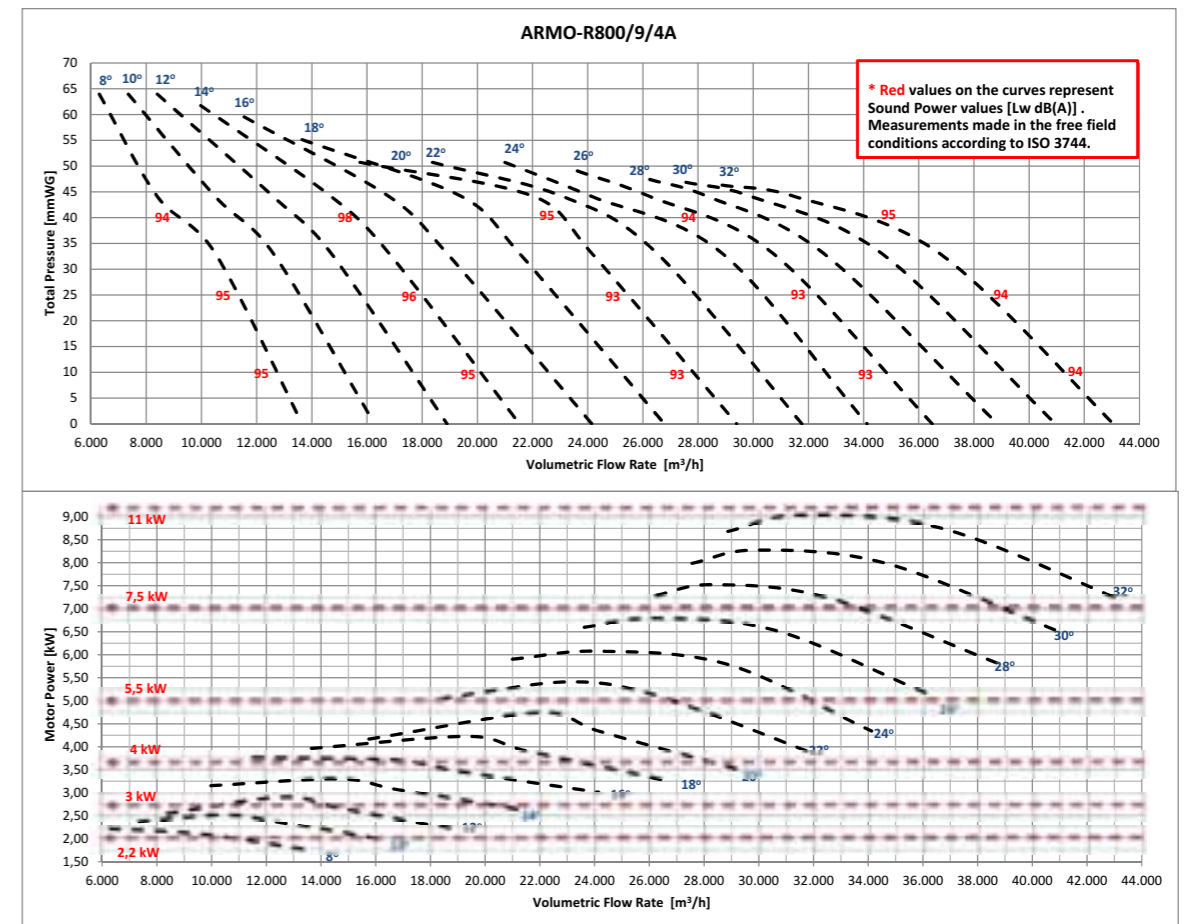
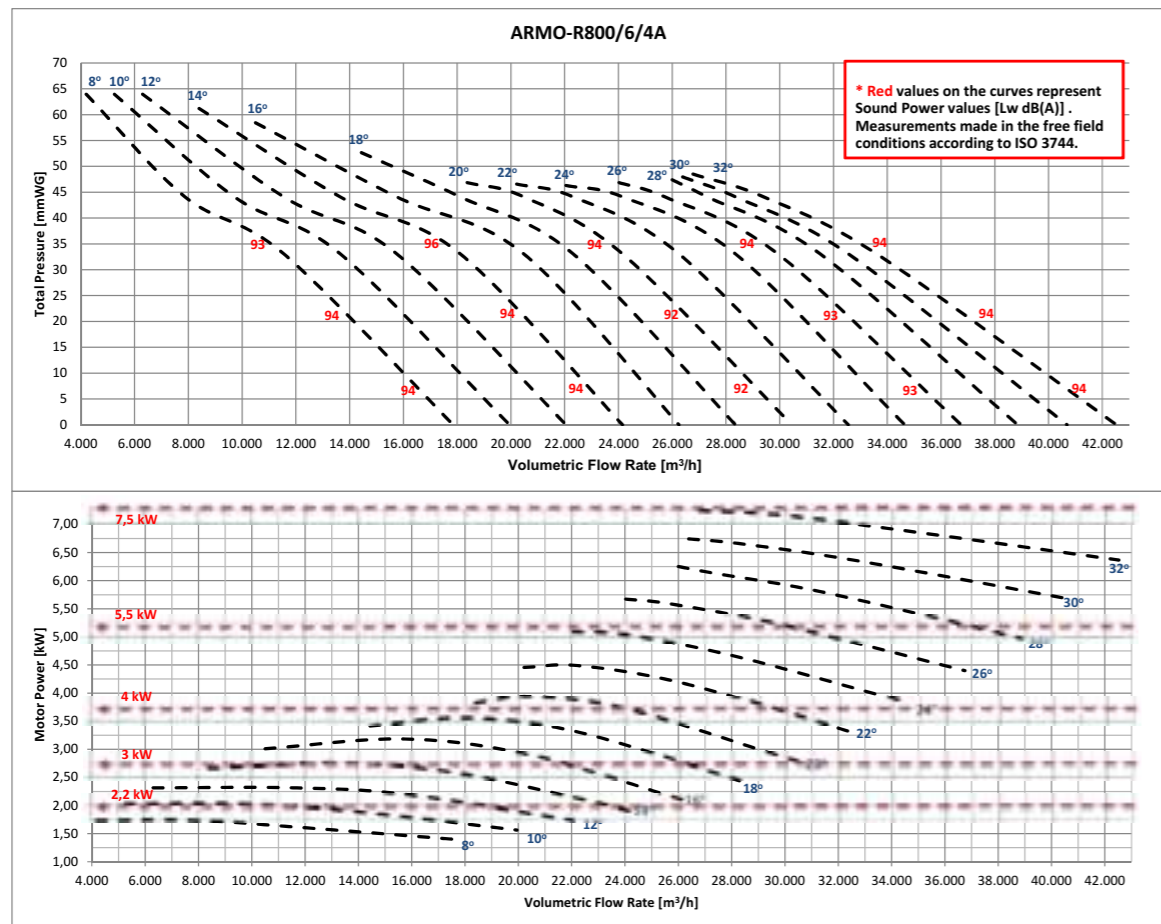
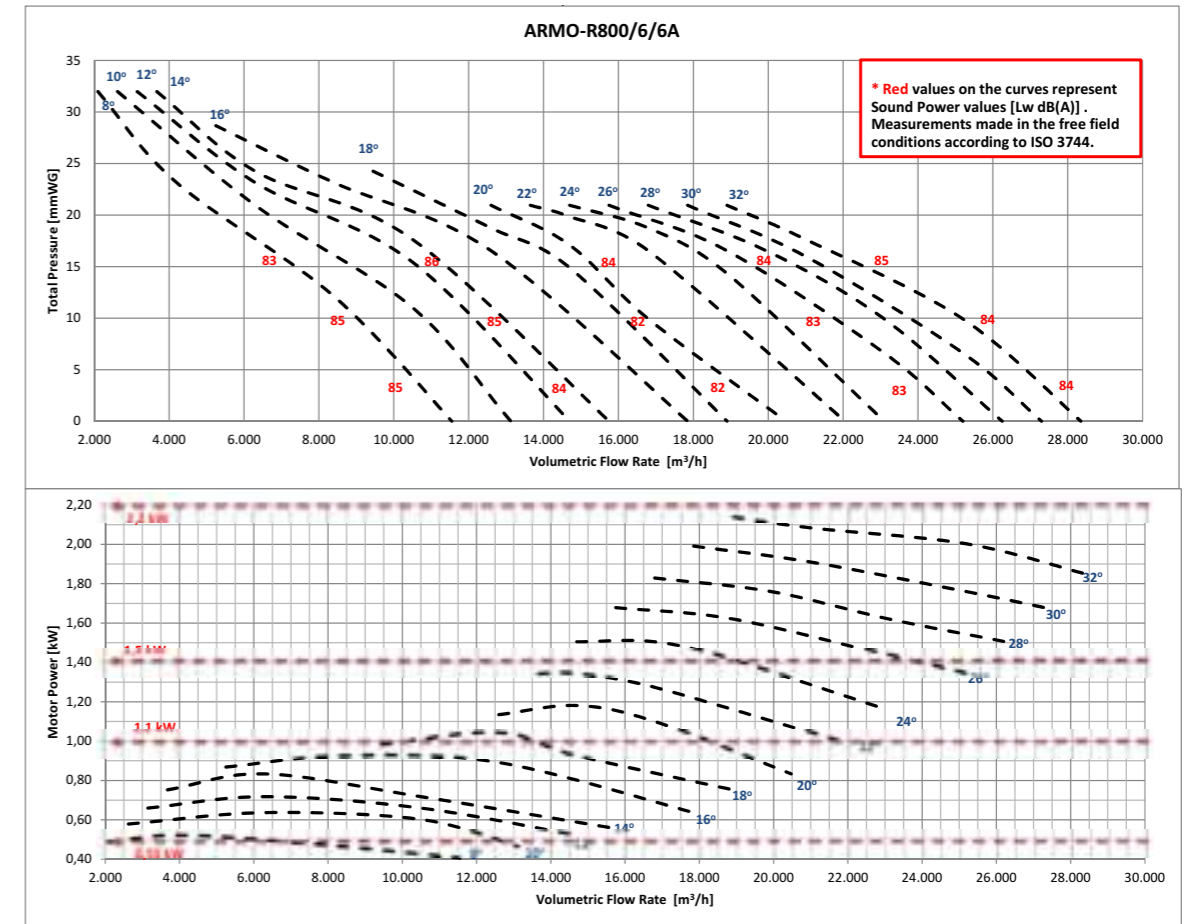
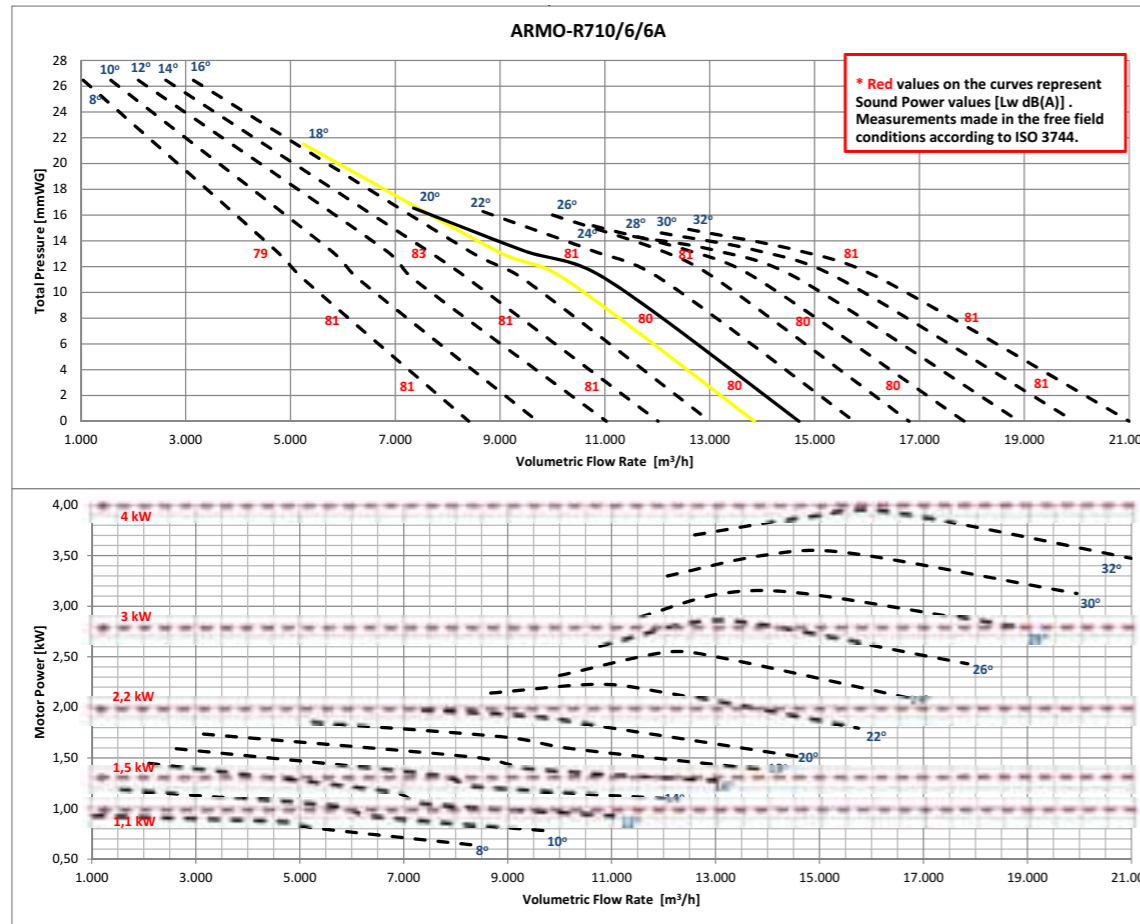

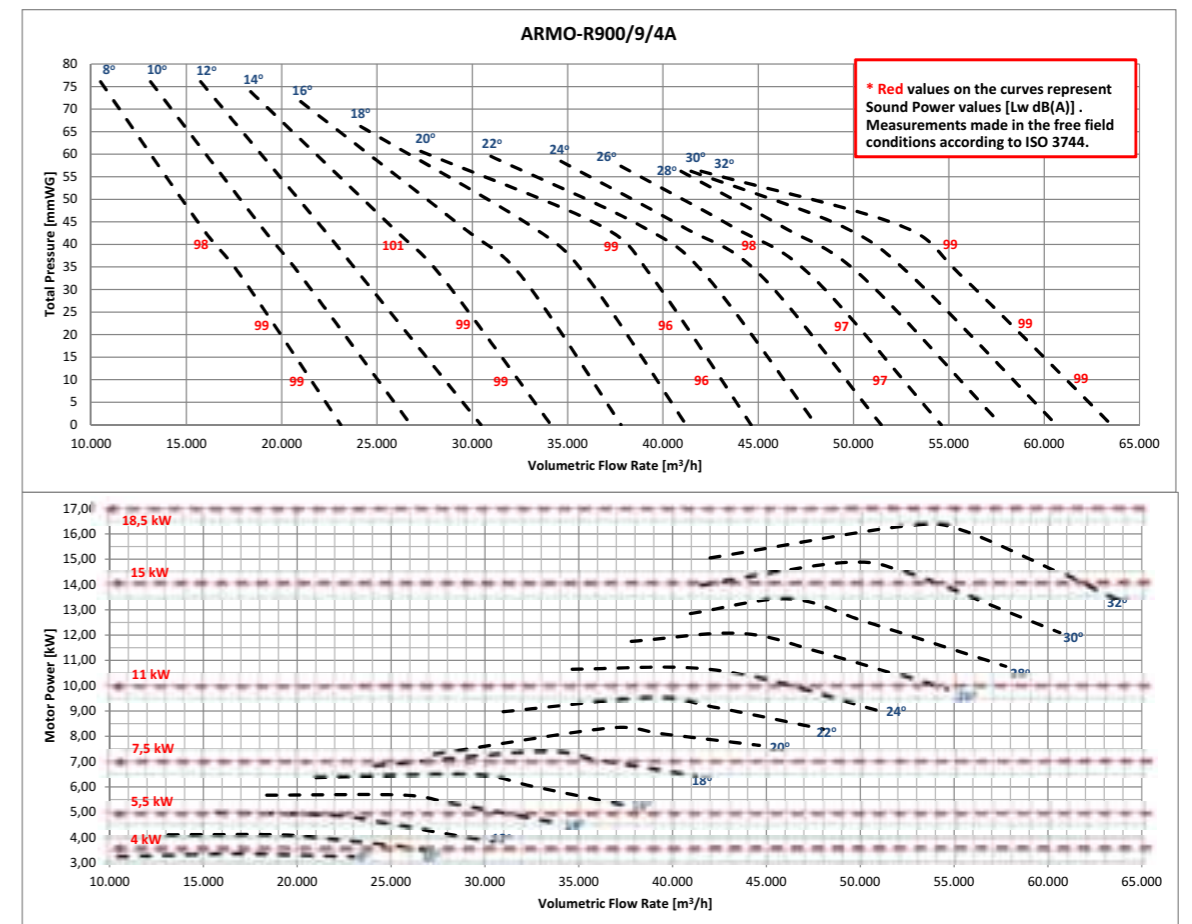
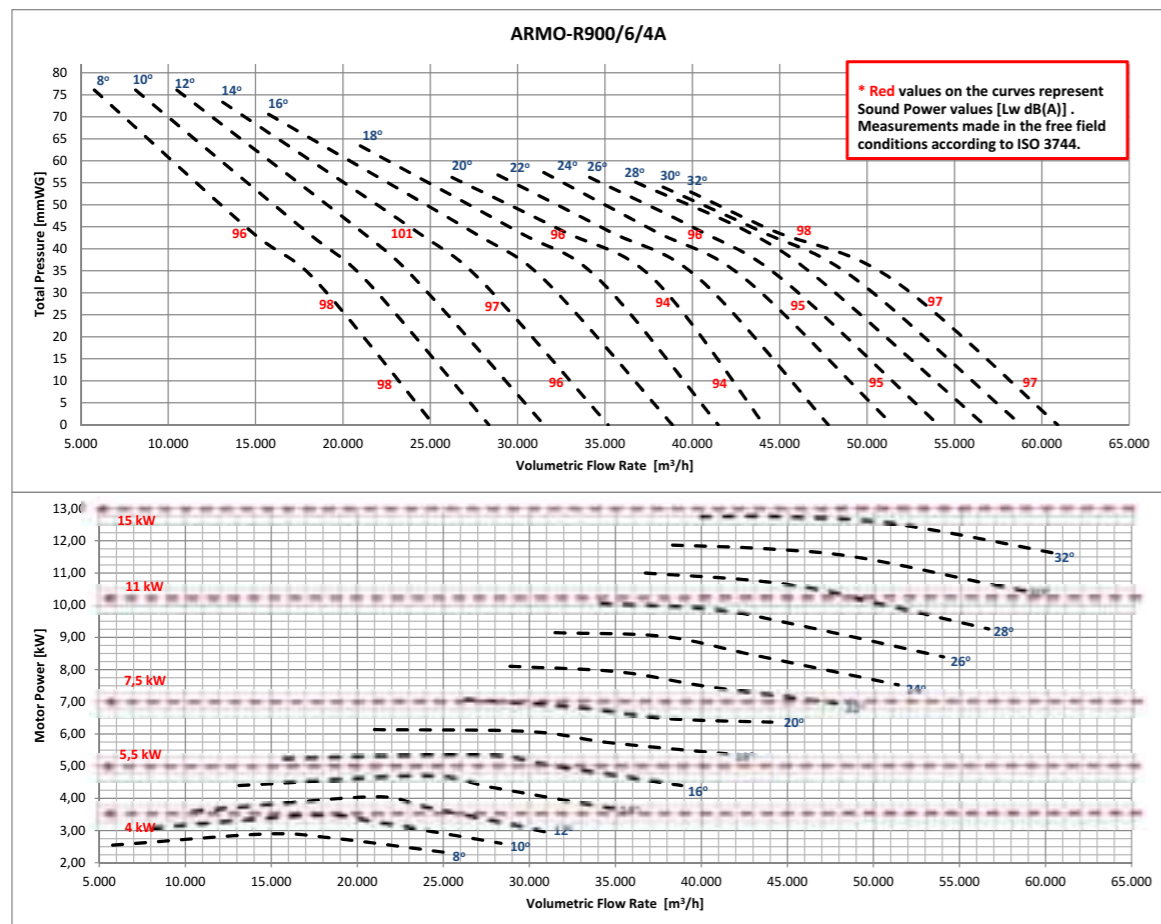
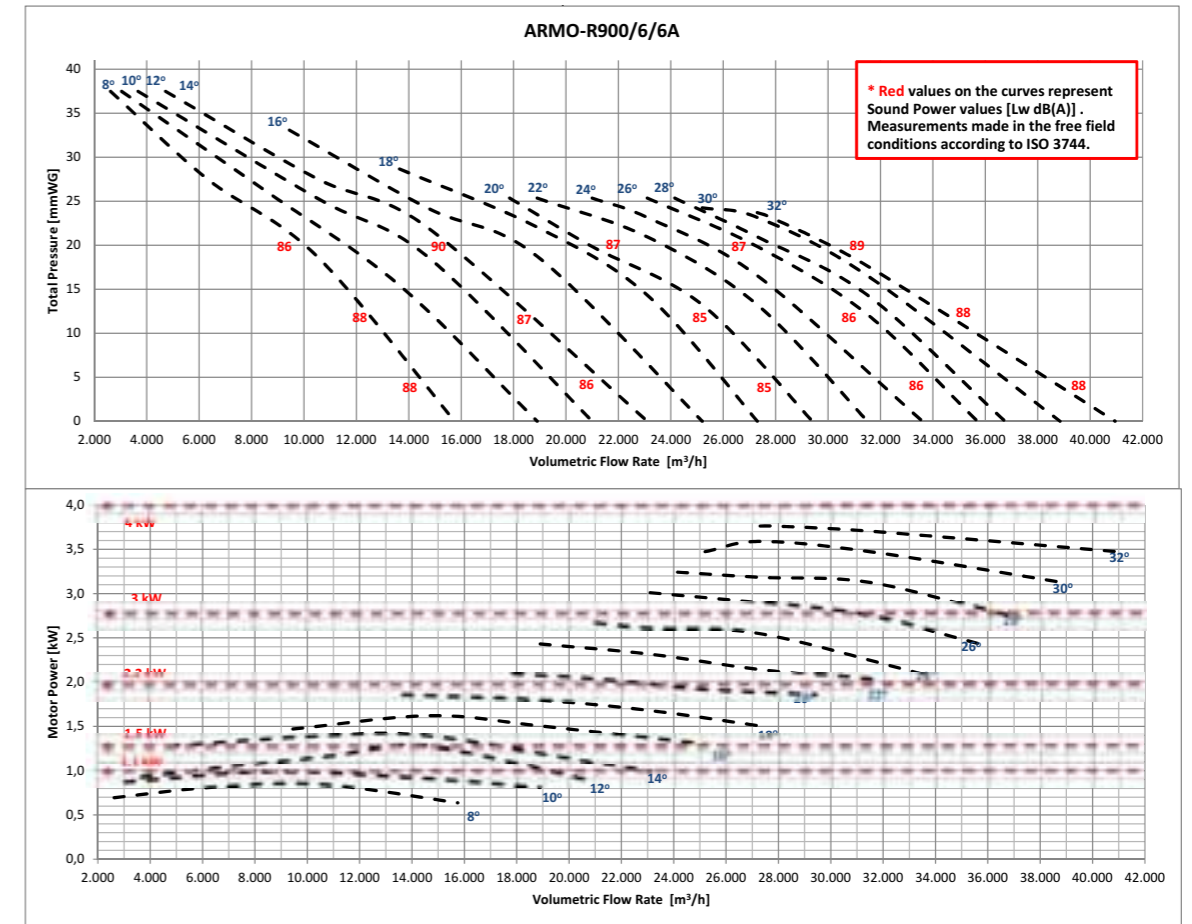
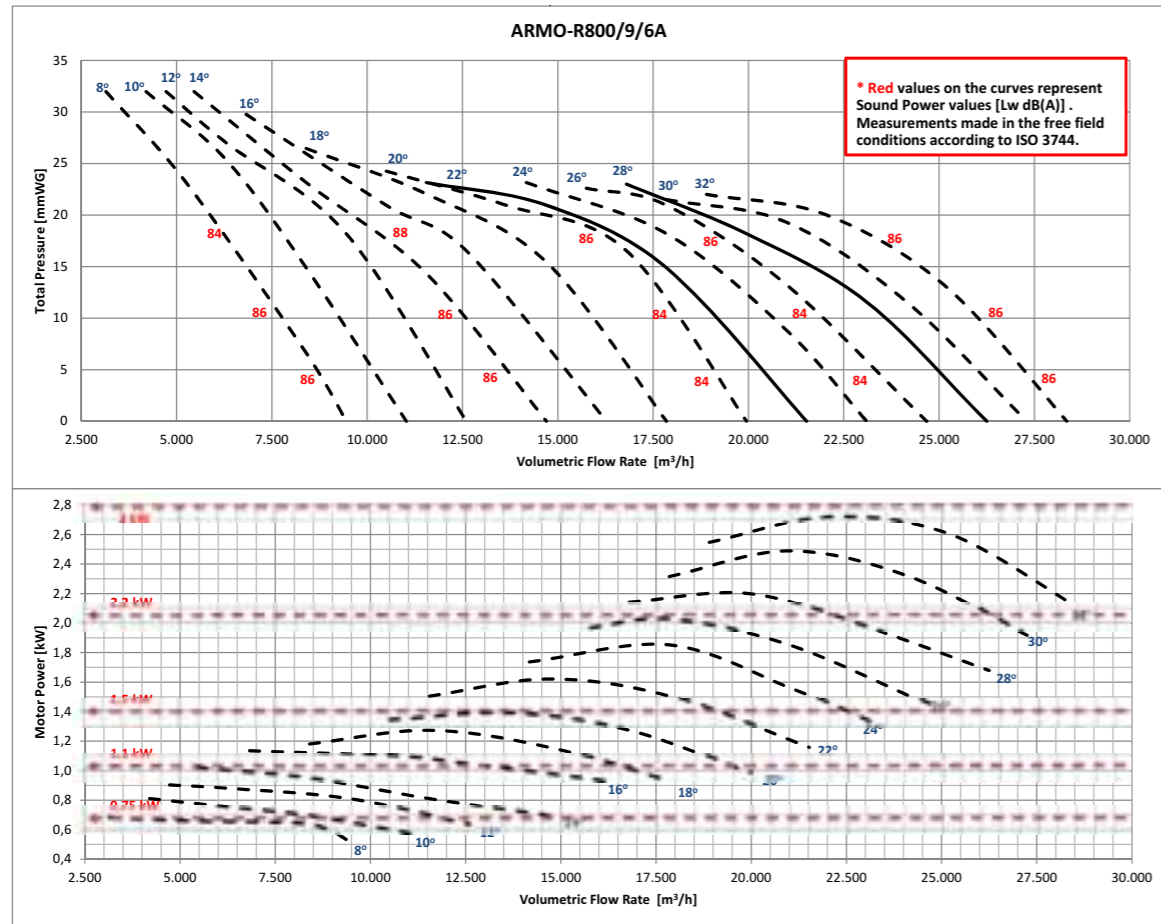

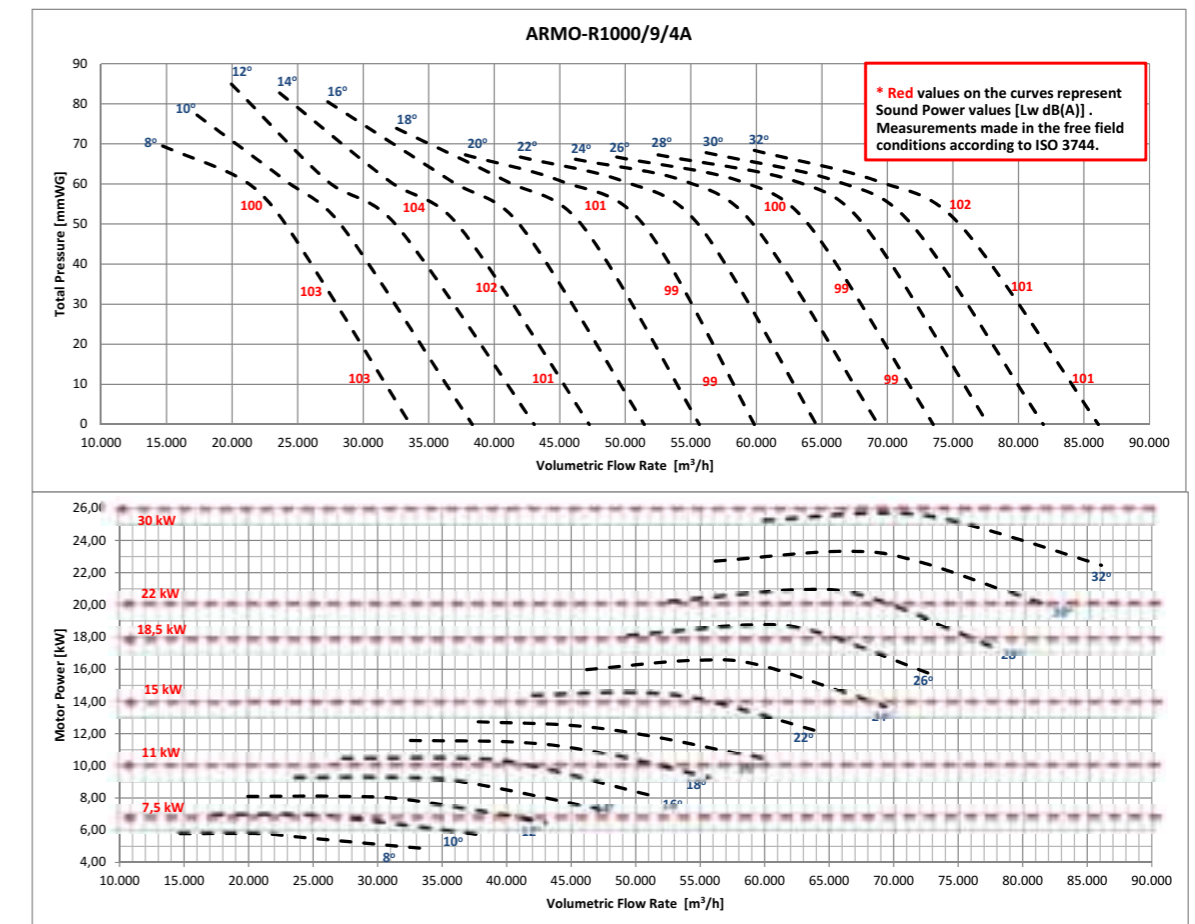
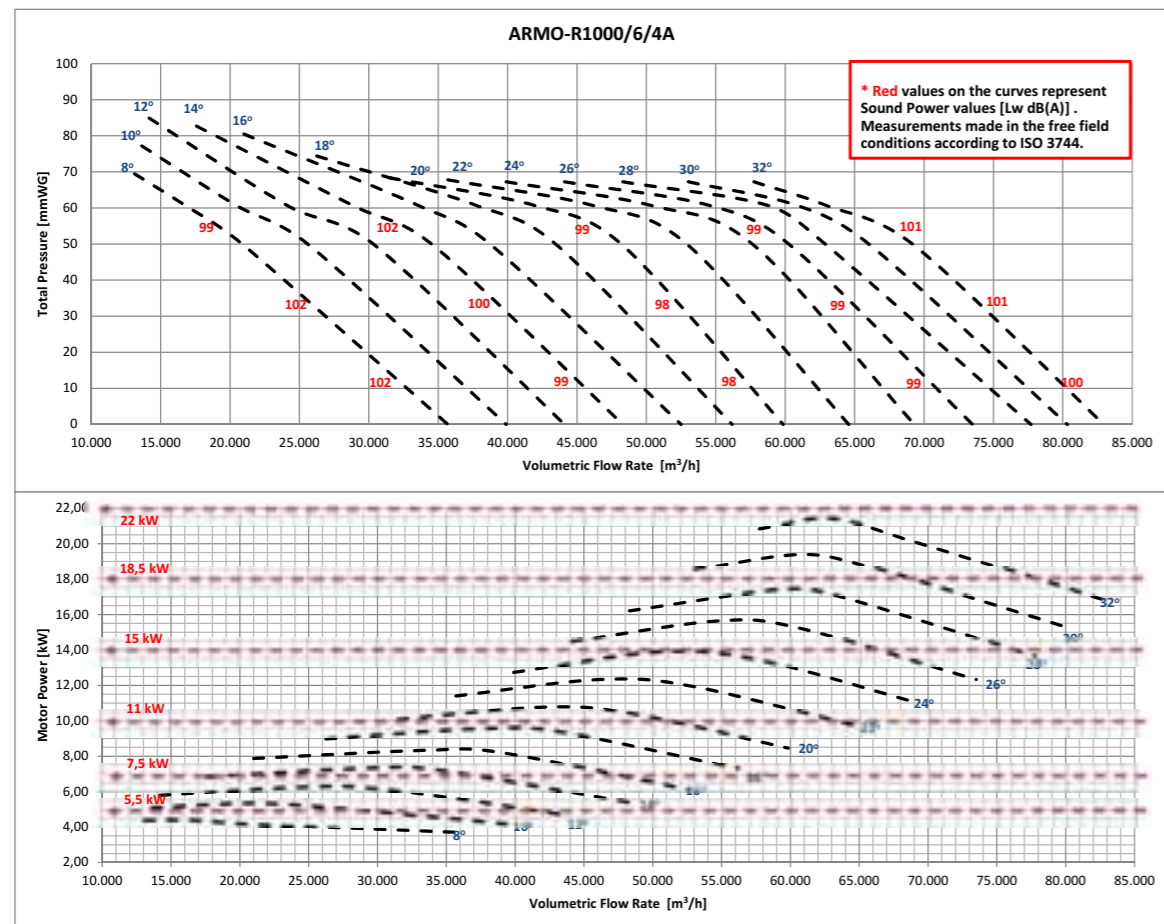
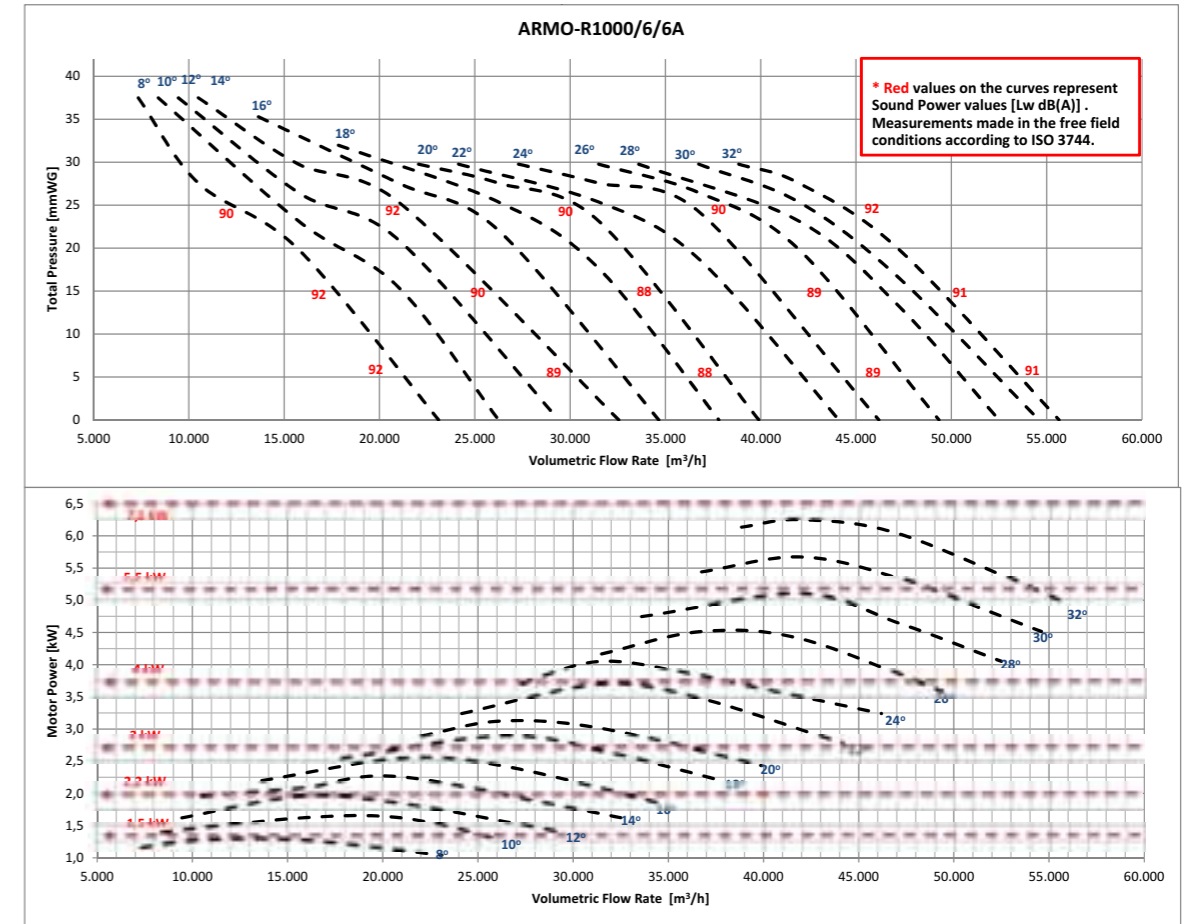
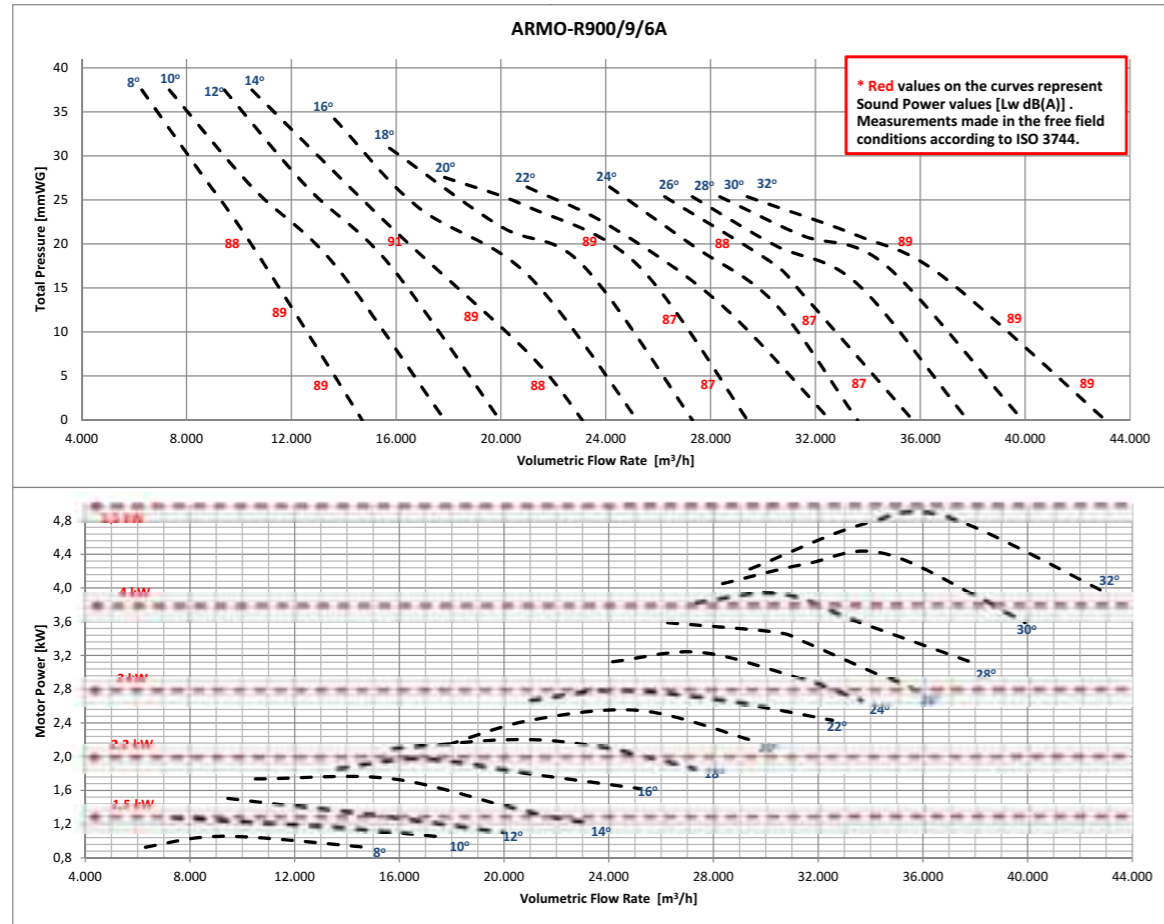

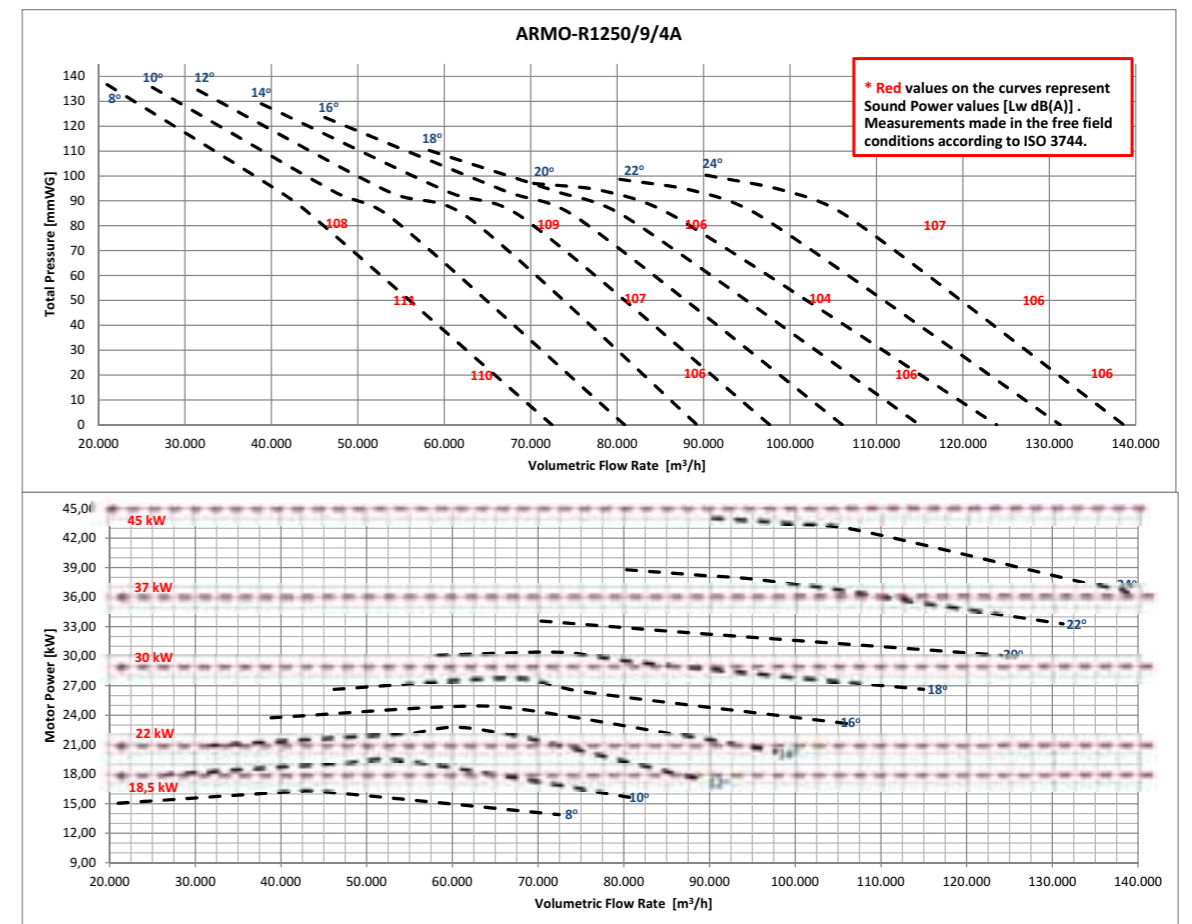
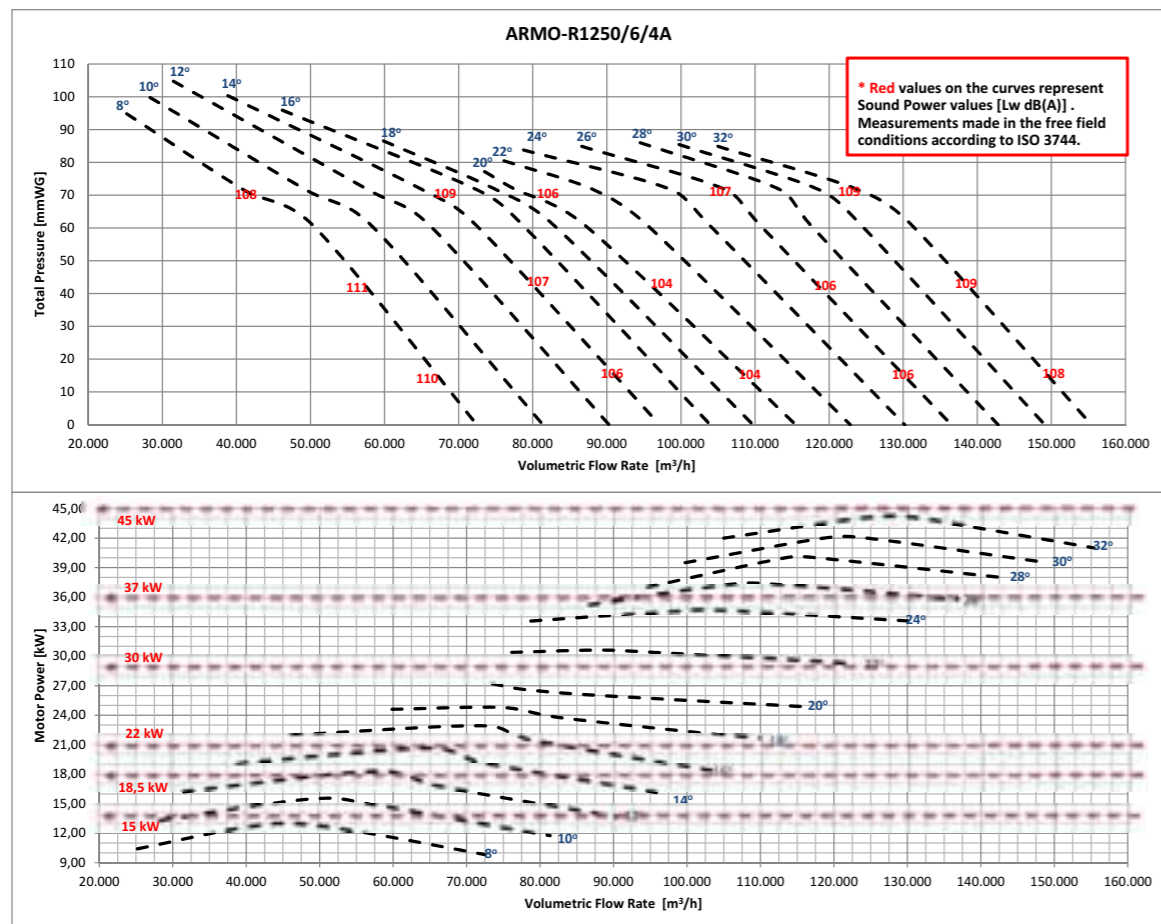
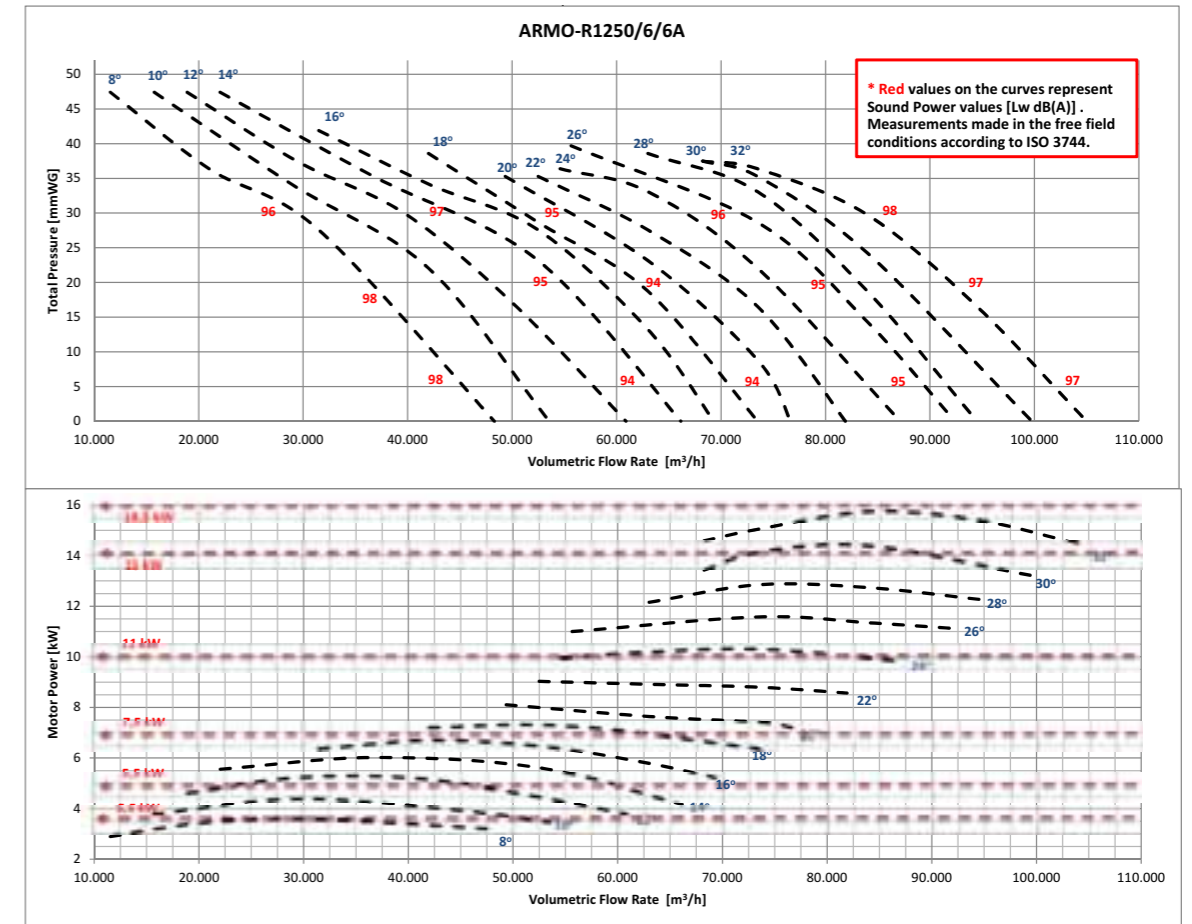
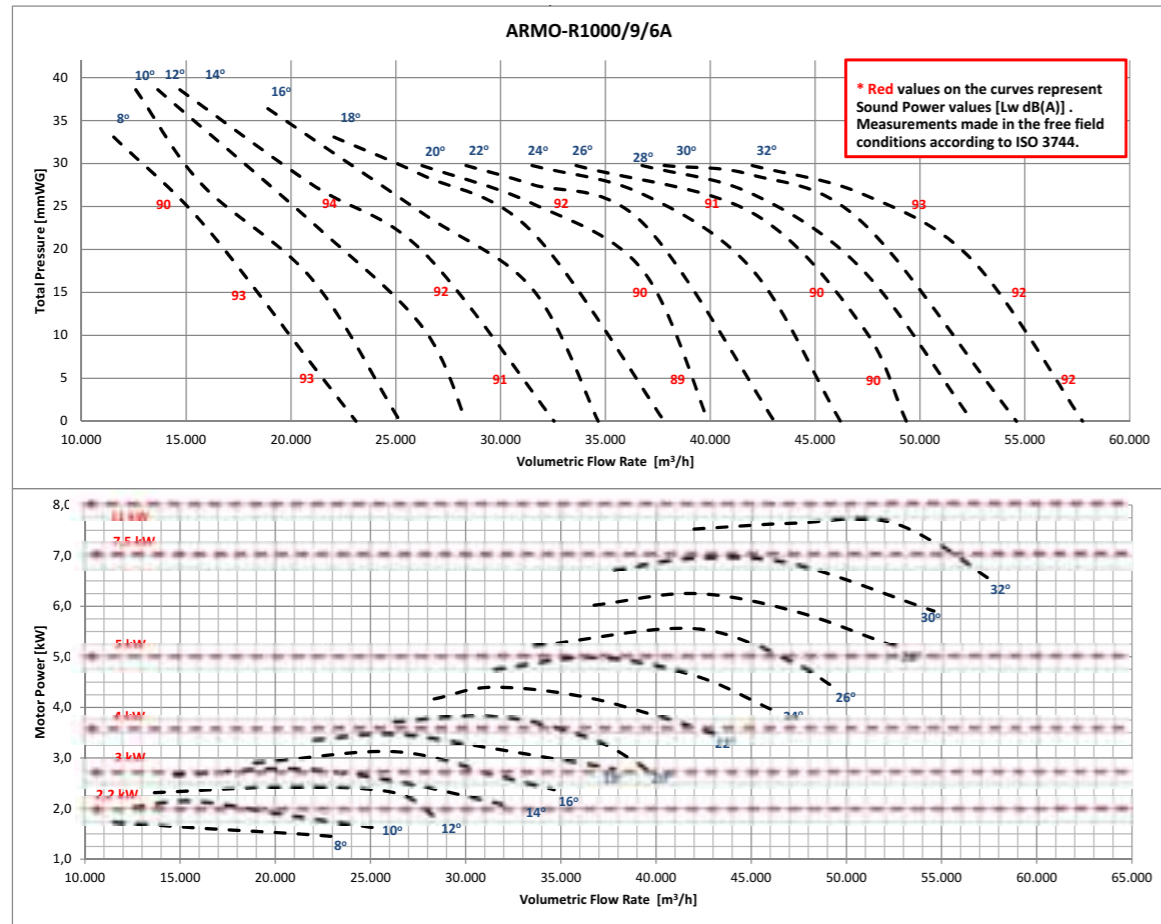

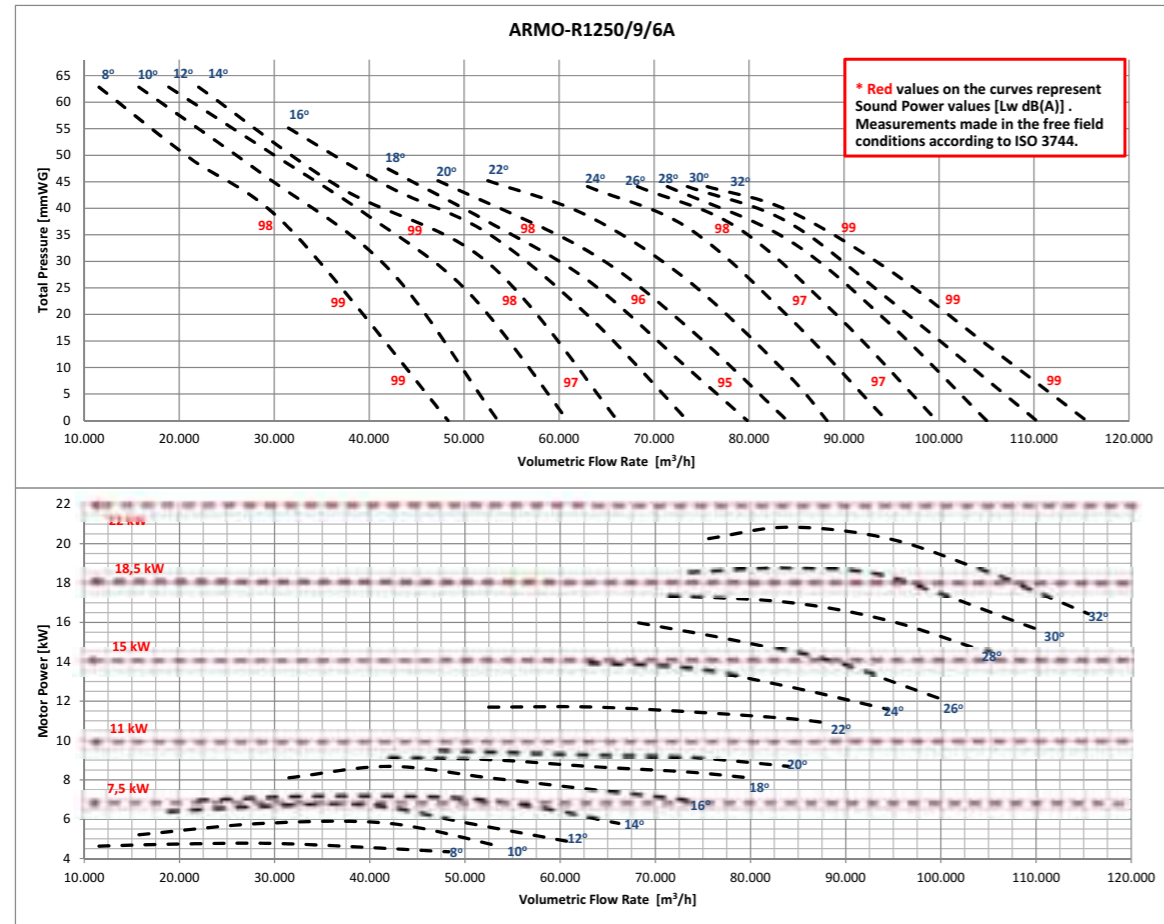

B6PA

INDUSTRIAL AXIAL FANS / 6 Blade

Fan Components and Material Properties

Body and protective wire cage are made of electrostatic powder coated steel. The motor and fan impeller are connected to the main body by steel carriers. The device is capable of handling air at max.40°C.

Fan Structure

The wings made of fiber glass composite materials are manufactured in airfoil structure to provide regular flow. Thanks to its aerodynamic wing structure, it works quietly.

Benefits

It works with low noise levels and is designed to be maintenance-free for long periods of time. It is manufactured with square frame which facilitates direct installation on the wall.

Speed can be adjusted with speed control devices. Propellers are manufactured in the most ideal angle according to their size and maximum performance is ensured.

Speed Control

Optional control devices can be provided. 1~phase products with linear voltage regulator speed control can be done. (see BSC accessory) 3~phase products can be controlled by frequency inverter (see BSC-F accessory).

Usage Areas

It is also used in the ventilation of high volume factories, paint shops, warehouses and hangars. It provides the ideal solution for large areas with its high flow rate.

Technical Drawing and Tables

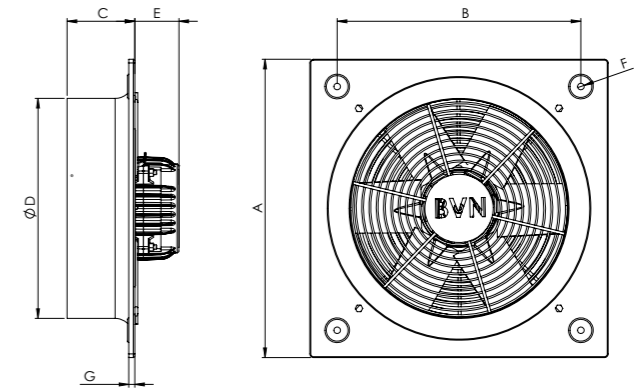

TYPE	A	B	C	D	E	F	G
B6PA 250	333	275	80	261	80	8.25	10
B6PA 300	412	336	80	307	80	8.25	10
B6PA 350	465	390	90	365	80	8.25	10
B6PA 400	500	420	100	403	80	8.25	10
B6PA 450	560	480	105	462	80	8.25	10
B6PA 500	630	561	110	513	90	8.25	10

Dimensions are in (mm)

TYPE	VOLTAGE	FREQUENCY	POWER	CURRENT	CAPACITOR	SPEED	AIR FLOW	SOUND PRESSURE	INSULATION CLASS	PROTECTION CLASS	WEIGHT
	V	Hz	W	(A)	(µF)	r.p.m	m³/h	dB(A)	Ins.cl.	IP	kg
B6 PAM 250	230	50/60	70/80	0,4/0,35	3	1450/1750	1500/1810	54	B	44	7,3
B6 PAM 300	230	50/60	85/110	0,45/0,48	3	1450/1700	2390/2800	57	B	44	8,5
B6 PAM 350	230	50/60	250/310	1,22/1,38	6	1400/1550	4080/4520	60	B	44	9,9
B6 PAM 400	230	50/60	255/310	1,24/1,39	6	1375/1500	5200/5670	63	B	44	10,4
B6 PAM 450	230	50/60	360/432	1,6/1,92	8	1250/1500	6100/7320	61	B	44	11,4
B6 PAM 500	230	50/60	440/530	2/2,4	8	1250/1500	7200/8640	66	B	44	13,6
B6 PAT 250	380	50/60	120/100	0,75/0,61	-	1450/1745	1500/1800	54	B	44	7,3
B6 PAT 300	380	50/60	150/180	0,65	-	1450/1700	2390/2800	57	B	44	8,5
B6 PAT 350	380	50/60	190/230	0,80/0,70	-	1400/1550	4080/4520	60	B	44	9,9
B6 PAT 400	380	50/60	255/320	0,8/0,76	-	1375/1600	5200/6050	63	B	44	10,4
B6 PAT 450	380	50/60	290/350	0,82/0,78	-	1250/1500	6100/7320	61	B	44	11,4
B6 PAT 500	380	50/60	370/450	0,84/0,88	-	1375	7200	66	B	44	13,6

Sound Level Measured from 3m distance in room condition.

Accessories



BSC

BASP

BTEK

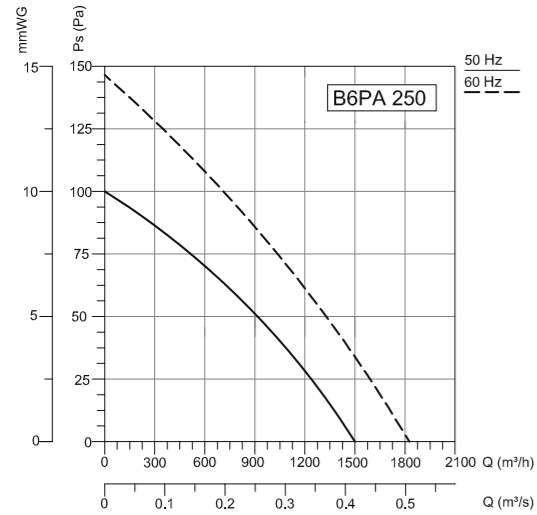

Frequency	Tot	63	125	250	500	1000	2000	4000	8000
L_{wa} Inlet	75	43	57	64	69	70	69	64	56

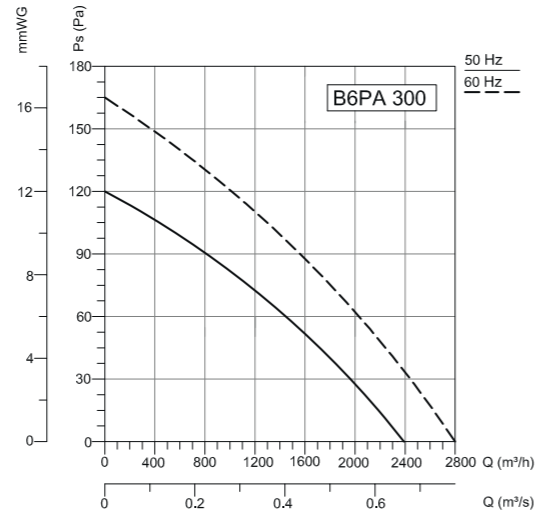

Frequency	Tot	63	125	250	500	1000	2000	4000	8000
L_{wa} Inlet	78	51	63	69	71	73	70	65	60

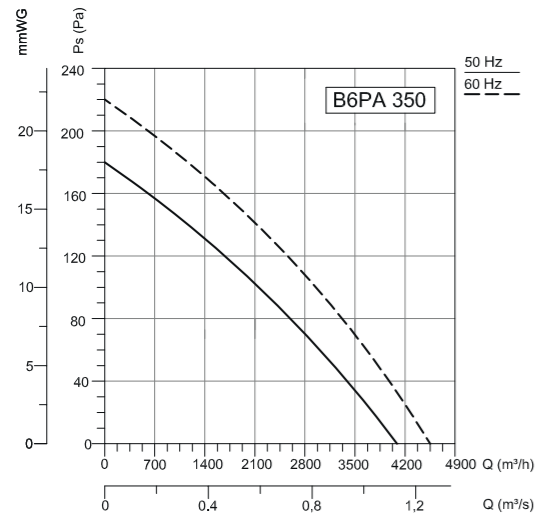

Frequency	Tot	63	125	250	500	1000	2000	4000	8000
L_{wa} Inlet	81	47	66	65	72	78	72	70	61

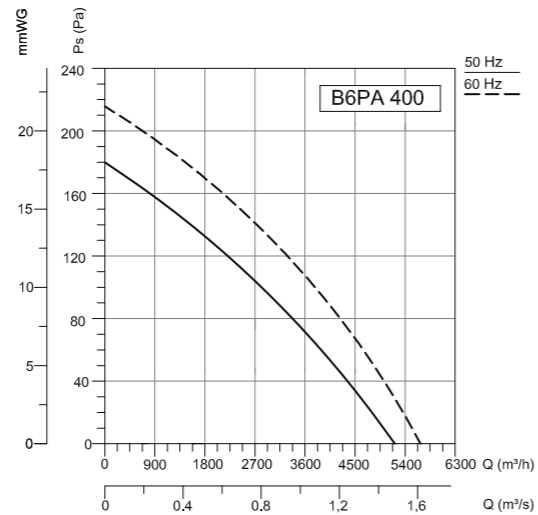

Frequency	Tot	63	125	250	500	1000	2000	4000	8000
L_{wa} Inlet	84	56	69	70	77	80	77	72	63

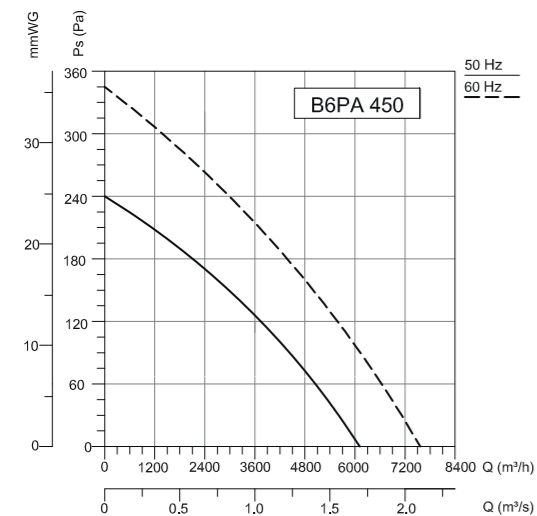

Frequency	Tot	63	125	250	500	1000	2000	4000	8000
L_{wa} Inlet	82	49	68	65	71	78	77	72	64

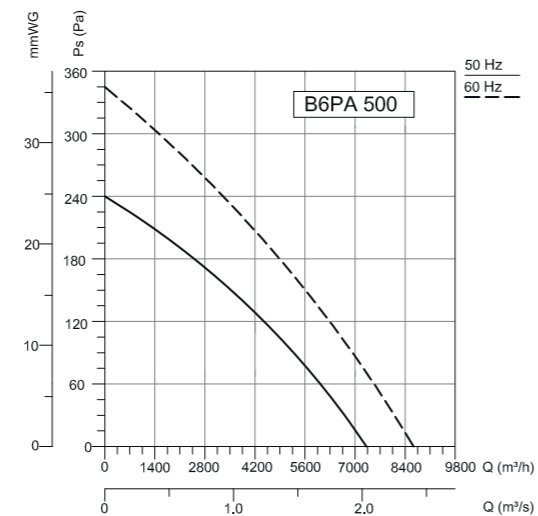

Frequency	Tot	63	125	250	500	1000	2000	4000	8000
L_{wa} Inlet	87	54	73	74	78	82	81	77	70



B5PA

INDUSTRIAL AXIAL FANS / 5 Blade

Fan Components and Material Properties

Body and protective wire cage are made of electrostatic powder coated steel. The motor and fan impeller are connected to the main body by steel carriers. The device is capable of handling air at max.40°C.

Fan Structure

The wings made of fiber glass composite materials are manufactured in airfoil structure to provide regular flow. Thanks to its aerodynamic wing structure, it works quietly.

Benefits

It works with low noise levels and is designed to be maintenance-free for long periods of time. It is manufactured with square frame which facilitates

direct installation on the wall. Speed can be adjusted with speed control devices. Propellers are manufactured in the most ideal angle according to their size and maximum performance is ensured.

Speed Control

Optional control devices can be provided. Speed control can be done with frequency inverter in 3-phase products. (see BSC-F accessory)

Usage Areas

It is also used in the ventilation of high volume factories, paint shops, warehouses and hangars. It provides the ideal solution for large areas with its high flow rate.

Technical Drawing and Tables

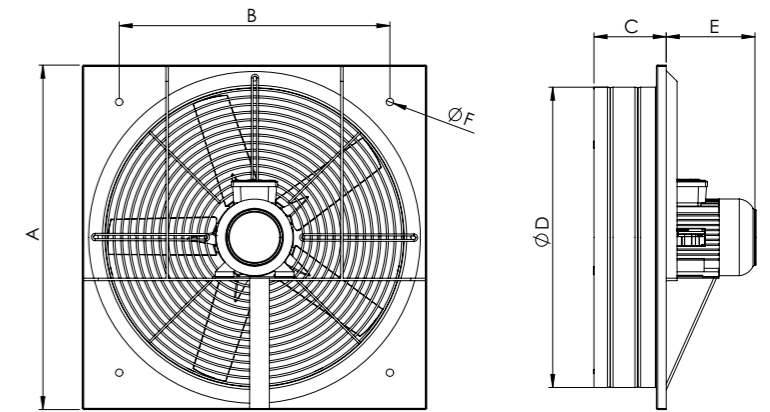

TYPE	A	B	C	D	E	F
B5PA 500	600	460	140	520	190	10
B5PA 600	700	550	140	610	190	15
B5PA 700	800	640	200	735	200	15
B5PA 800	950	770	235	835	250	15
B5PA 900	1100	900	260	935	250	15
B5PA 1000	1200	960	275	1035	275	15

Dimensions are in (mm)

TYPE	VOLTAGE	FREQUENCY	POWER	CURRENT	CAPACITOR	SPEED	AIR FLOW	SOUND PRESSURE	INSULATION CLASS	PROTECTION CLASS	WEIGHT
	V	Hz	kW	(A)	(µF)	r.p.m	m³/h	dB(A)	Ins.cl.	IP	kg
B5PAM 500	230	50	0,55	3,3	20	1365	8500	68	F	55	16,6
B5PAM 600	230	50	0,75	4,6	30	1405	10500	70	F	55	20,5
B5PAM 700	230	50	1,1	7,1	35	1410	14000	75	F	55	33
B5PAM 800	230	50	2,2	13,4	60	1425	20000	80	F	55	52
B5PAT 500	380	50	0,55	1,6	-	1365	8500	68	F	55	16,6
B5PAT 600	380	50	0,75	2,1	-	1405	10500	70	F	55	20,5
B5PAT 700	380	50	1,1	2,6	-	1410	14000	75	F	55	33
B5 PAT 800	380	50	2,2	5,0	-	1425	20000	80	F	55	52
B5PAT 900	380	50	4	8,4	-	1440	32000	82	F	55	61
B5PAT 1000	380	50	5,5	11,2	-	1465	37000	85	F	55	90

Sound Level Measured from 3m distance in room condition.

Accessories

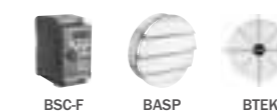

BSC-F

BASP

BTEK

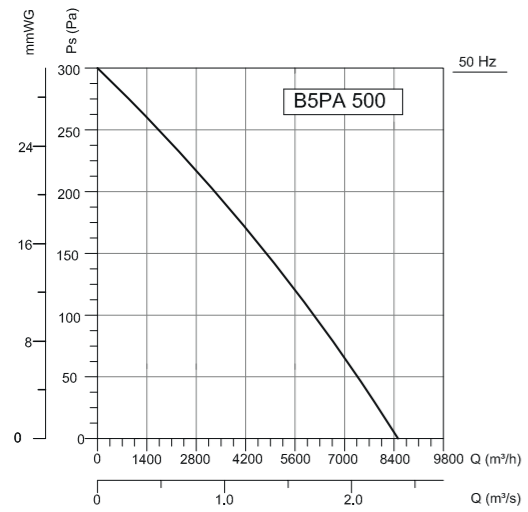

Frequency	Tot	63	125	250	500	1000	2000	4000	8000	Hz
L_{WA} Inlet	89	61	74	78	82	84	82	78	71	dB(A)

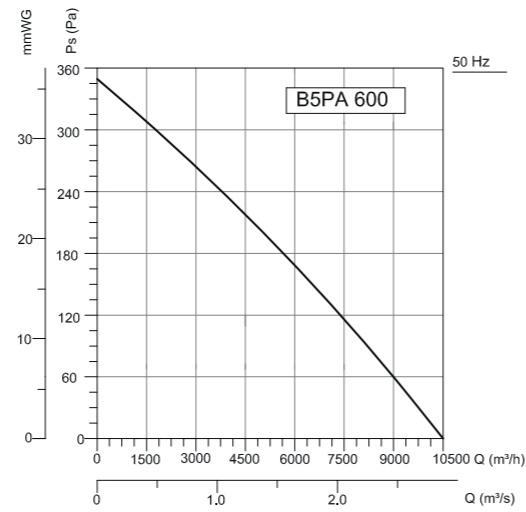

Frequency	Tot	63	125	250	500	1000	2000	4000	8000	Hz
L_{WA} Inlet	91	59	74	78	83	87	84	81	77	dB(A)

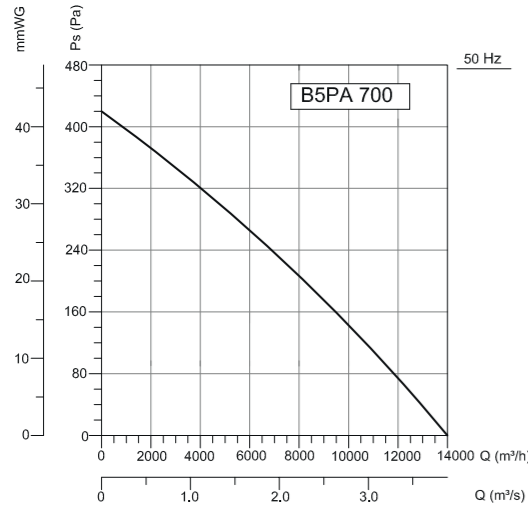

Frequency	Tot	63	125	250	500	1000	2000	4000	8000	Hz
L_{WA} Inlet	96	64	79	83	88	92	89	86	82	dB(A)

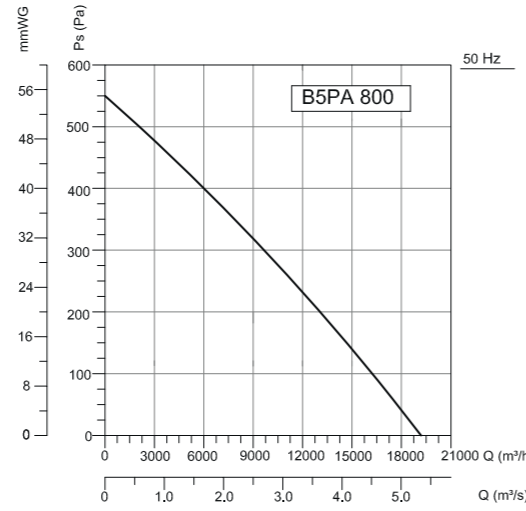

Frequency	Tot	63	125	250	500	1000	2000	4000	8000	Hz
L_{WA} Inlet	101	69	84	88	93	97	94	91	87	dB(A)

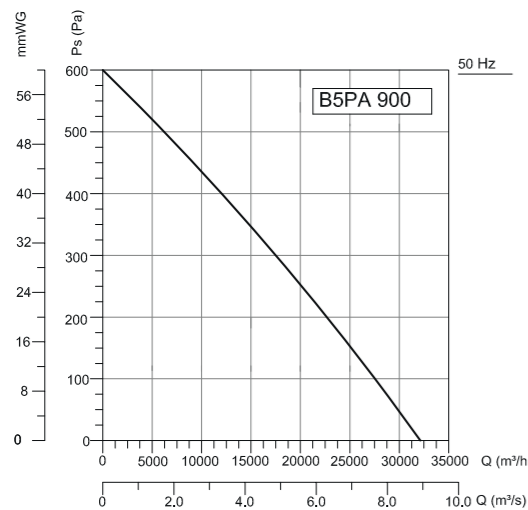

Frequency	Tot	63	125	250	500	1000	2000	4000	8000	Hz
L_{WA} Inlet	103	71	86	90	95	99	96	93	89	dB(A)

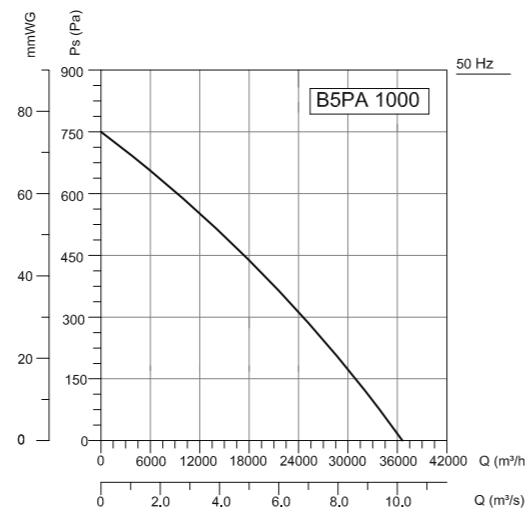

Frequency	Tot	63	125	250	500	1000	2000	4000	8000	Hz
L_{WA} Inlet	106	74	89	93	98	102	99	96	92	dB(A)



BSM-BST INDUSTRIAL AXIAL FANS

Fan Components and Material Properties

Body and propeller are made of electrostatic powder coated sheet metal. The axial flaps are produced in an aerodynamic manner to ensure a smooth flow. The protective wire mesh is made of steel with electrostatic powder coating. The motor and fan impeller are connected to the main body by steel carriers.

Benefits

Thanks to their ideal wing angles, they achieve high air flow at minimum sound levels despite their small size. It has a compact design in high flow. Easily mounted on windows and wall.

Speed Control

Optional control devices can be provided. 1-phase products with linear voltage regulator speed control can be done. (see BSC accessory) 3-phase products can be controlled by frequency inverter (see BSC-F accessory).

Usage Areas

Factories, warehouses, paint shops, shopping centers, etc. used for the ventilation of high volume places.

Technical Drawing and Tables

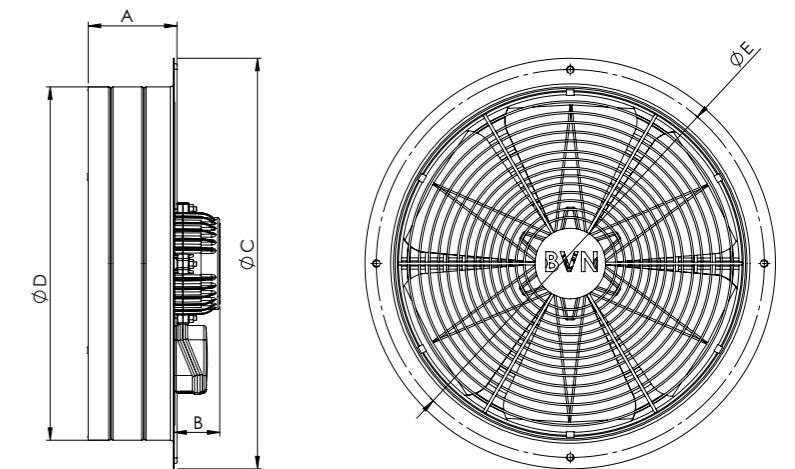

TYPE	A	B	C	D	E
BSM 250 / BST 250	114	61	304	251	277
BSM 300 / BST 300	114	61	390	325	360
BSM 350 / BST 350	114	61	435	374	405
BSM 400 / BST 400	114	61	485	427	455
BSM 450 / BST 450	114	61	546	470	516
BSM 500 / BST 500	125	61	590	518	560
BSM 550 / BST 550	130	160	624	560	595
BSM 600 / BST 600	130	160	674	610	645
BSM 250-2K / BST 250-2K	114	61	304	251	277

Dimensions are in (mm)

Accessories



BSC BSC-F BASP

TYPE	VOLTAGE	FREQUENCY	POWER	CURRENT	CAPACITOR	SPEED	AIR FLOW	SOUND PRESSURE	INSULATION CLASS	PROTECTION CLASS	WEIGHT
	V	Hz	W	(A)	(μ F)	r.p.m	m ³ /h	dB(A)	Ins.cl.	IP	kg
BSM 250-2K	230	50/60	150/190	1/0,85	8	2900/3250	2200/2465	61	B	44	7,4
BSM 250	230	50/60	65/75	0,4/0,3	3	1475/1770	1200	45	B	44	7,4
BSM 300	230	50/60	90/110	0,45/0,50	3	1445/1700	2000	48	B	44	8
BSM 350	230	50/60	160	1,05/0,85	6	1460/1750	3250/3895	53	B	44	8,2
BSM 400	230	50/60	185	1,17/0,95	6	1425/1725	4500/5445	56	B	44	8,8
BSM 450	230	50/60	200/190	1,1/0,9	6	1430/1730	5000/6050	60	B	44	10
BSM 500	230	50/60	230	1,1	8	1440/1700	5500/6495	62	B	44	11
BSM 550	230	50/60	220/320	1,07/1,64	10	1440/1700	6000/7080	63	B	44	14,6
BSM 600	230	50/60	235/340	1,15/1,65	10	1400/1670	8000/9540	65	B	44	15,6
BST 250-2K	380	50/60	110/140	0,87/1,05	-	2900/3250	2200/2465	61	B	44	7,4
BST 250	380	50/60	50/60	0,25/0,35	-	1475/1770	1200	45	B	44	7,4
BST 300	380	50/60	70/85	0,30/0,36	-	1445/1700	2000	48	B	44	8
BST 350	380	50/60	120	0,45/0,55	-	1460/1750	3250/3895	53	B	44	8,2
BST 400	380	50/60	150	0,75/0,9	-	1425/1725	4500/5445	56	B	44	8,8
BST 450	380	50/60	170/200	1,1/0,9	-	1430/1730	5000/6050	60	B	44	10
BST 500	380	50/60	200	1,1	-	1440/1700	5500/6495	62	B	44	11
BST 550	380	50/60	220/320	1,07/1,64	-	1440/1700	6000/7080	63	B	44	14,6
BST 600	380	50/60	235/340	1,15/1,65	-	1400/1670	8000/9540	65	B	44	15,6

The sound level is measured at a distance of 3 m in open field condition.

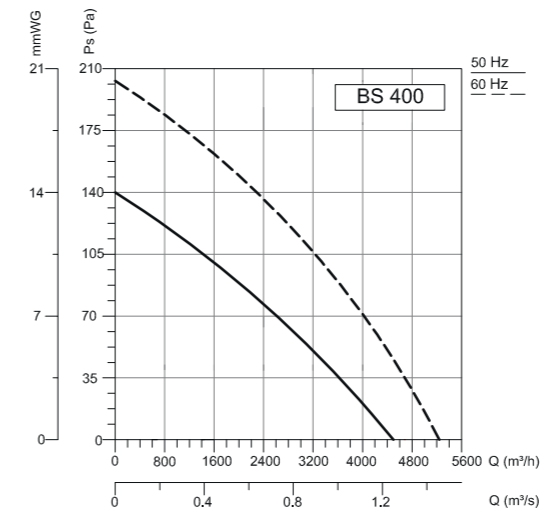

Frequency	Tot	63	125	250	500	1000	2000	4000	8000	Hz
L _{wa} Surrounding	77	49	62	63	70	73	70	65	56	dB(A)

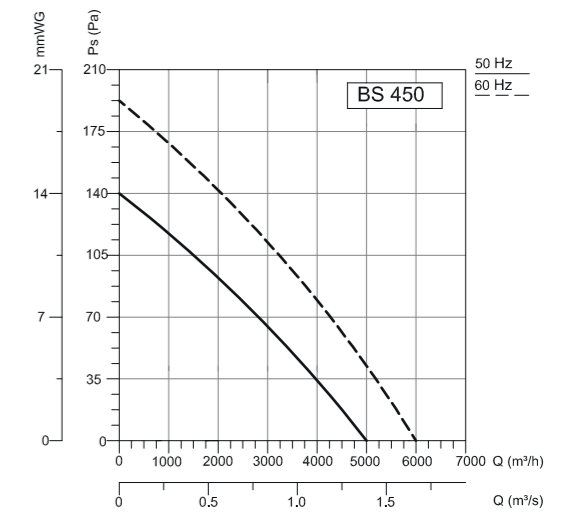

Frequency	Tot	63	125	250	500	1000	2000	4000	8000	Hz
L _{wa} Surrounding	81	48	67	64	70	77	76	71	63	dB(A)

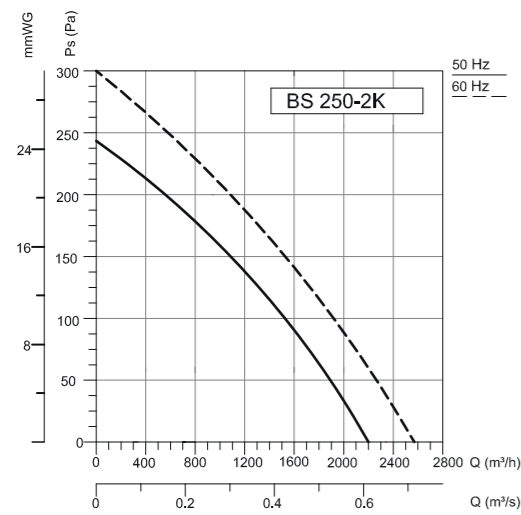

Frequency	Tot	63	125	250	500	1000	2000	4000	8000	Hz
L _{wa} Surrounding	82	56	67	76	75	77	75	70	64	dB(A)

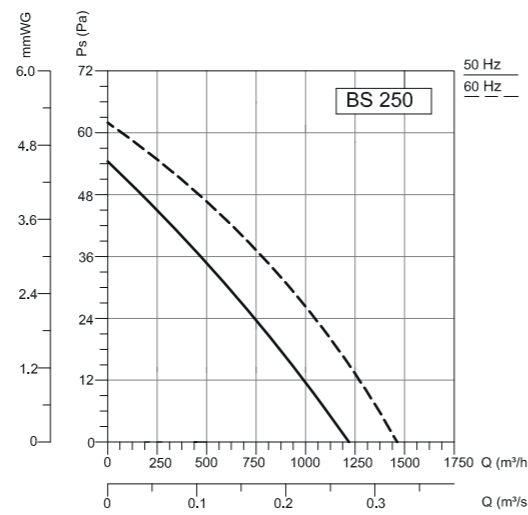

Frequency	Tot	63	125	250	500	1000	2000	4000	8000	Hz
L _{wa} Surrounding	66	34	48	55	60	61	60	55	47	dB(A)

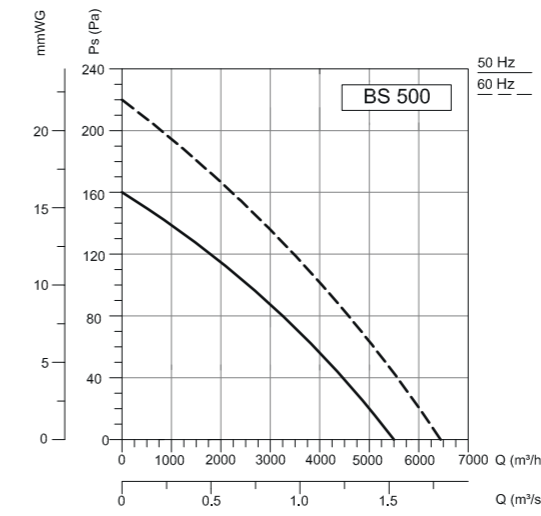

Frequency	Tot	63	125	250	500	1000	2000	4000	8000	Hz
L _{wa} Surrounding	83	50	69	70	74	78	77	73	66	dB(A)

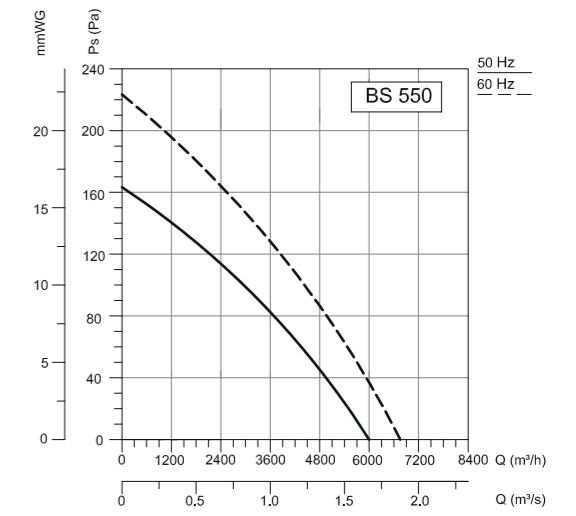

Frequency	Tot	63	125	250	500	1000	2000	4000	8000	Hz
L _{wa} Surrounding	85	57	70	74	78	80	78	74	67	dB(A)

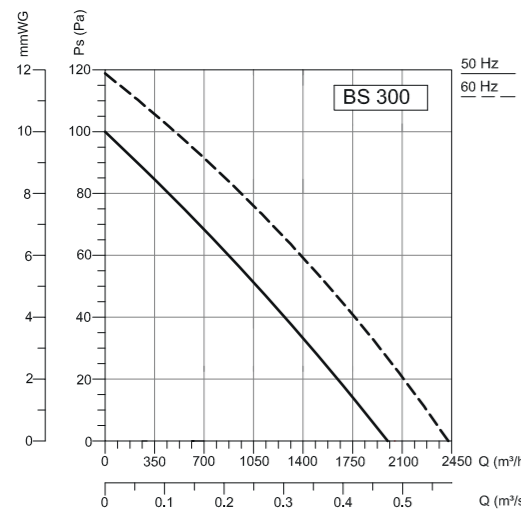

Frequency	Tot	63	125	250	500	1000	2000	4000	8000	Hz
L _{wa} Surrounding	69	43	54	60	62	64	61	56	51	dB(A)

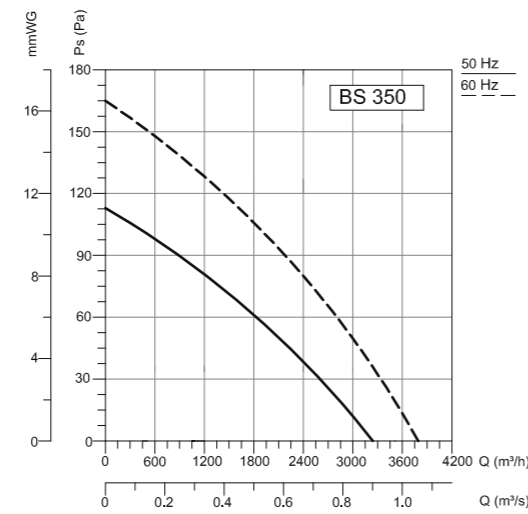

Frequency	Tot	63	125	250	500	1000	2000	4000	8000	Hz
L _{wa} Surrounding	74	40	59	58	65	71	65	63	54	dB(A)

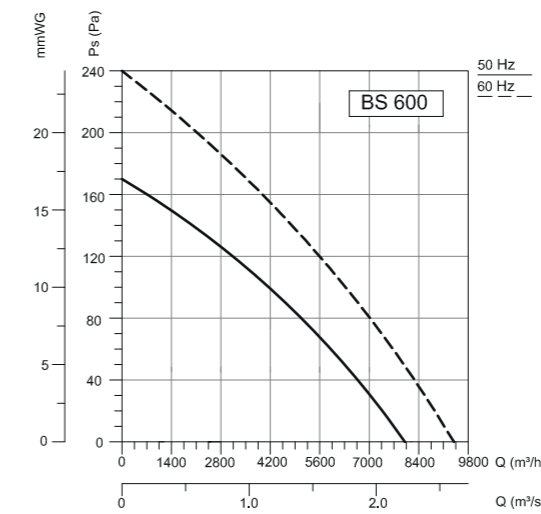

Frequency	Tot	63	125	250	500	1000	2000	4000	8000	Hz
L _{wa} Surrounding	86	54	69	73	78	82	79	76	72	dB(A)



BSMS-BSTS

INDUSTRIAL AXIAL FANS

Fan Components and Material Properties

Body and propeller are made of electrostatic powder coated sheet metal. The axial flaps are produced in an aerodynamic manner to ensure a smooth flow. The protective wire mesh is made of steel with electrostatic powder coating. The motor and fan impeller are connected to the main body by steel carriers.

Benefits

Thanks to their ideal wing angles, they achieve high air flow at minimum sound levels despite their small size. It has a compact design in high flow. Thanks to its square frames, it is easy to install on the wall and window.

Speed Control

Optional control devices can be provided. 1~phase products with linear voltage regulator speed control can be done. (see BSC accessory) 3~phase products can be controlled by frequency inverter (see BSC-F accessory).

Usage Areas

Factories, warehouses, paint shops, shopping centers, etc. used for the ventilation of high volume places.

Technical Drawing and Tables

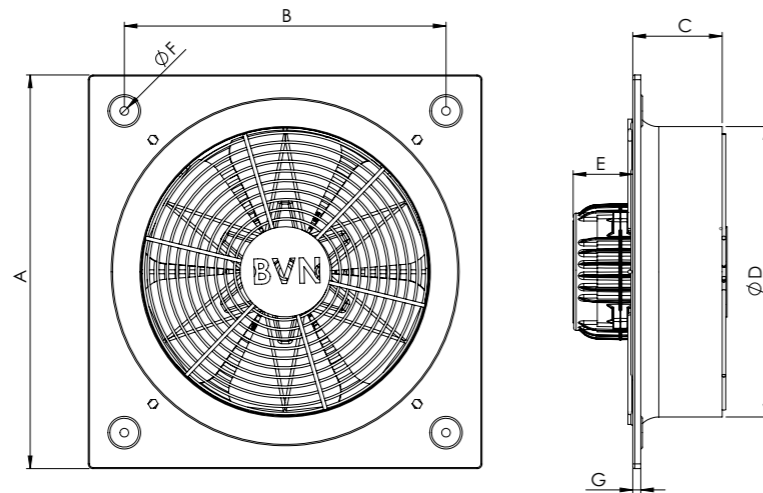

TYPE	A	B	C	D	E	F	G
BSMS 250 / BSTS 250	333	275	80	261	80	8	10
BSMS 300 / BSTS 300	412	336	80	307	80	8	10
BSMS 350 / BSTS 350	465	390	90	365	80	8	10
BSMS 400 / BSTS 400	500	420	100	403	80	8	10
BSMS 450 / BSTS 450	560	480	105	462	80	8	10
BSMS 500 / BSTS 500	630	561	110	513	90	8	10
BSMS 550 / BSTS 550	660	585	145	565	135	8	10
BSMS 600 / BSTS 600	700	631	145	612	135	8	10
BSMS 250-2K/BSTS 250-2K	333	275	80	261	80	8	10

Dimensions are in (mm)

Accessories



BSC

BSC-F

BASP

TYPE	VOLTAGE	FREQUENCY	POWER	CURRENT	CAPACITOR	SPEED	AIR FLOW	SOUND PRESSURE	INSULATION CLASS	PROTECTION CLASS	WEIGHT
	V	Hz	W	(A)	(µF)	r.p.m	m³/h	dB(A)	Ins.cl.	IP	kg
BSMS 250-2K	230	50/60	150/190	1,0/0,85	8	2900/3250	2200/2465	61	B	44	6,3
BSMS 250	230	50/60	65/75	0,4/0,3	3	1475/1770	1200	45	B	44	6
BSMS 300	230	50/60	90/110	0,45/0,50	3	1445/1700	2000	48	B	44	7
BSMS 350	230	50/60	160	1,05/0,85	6	1460/1750	3250/3895	53	B	44	8,2
BSMS 400	230	50/60	185	1,17/0,95	6	1425/1725	4500/5445	56	B	44	9
BSMS 450	230	50/60	200/190	1,1/0,9	6	1430/1730	5000/6050	60	B	44	9,6
BSMS 500	230	50/60	230	1,1	8	1440/1700	5500/6495	62	B	44	11
BSMS 550	230	50/60	220/320	1,07/1,64	10	1440/1700	6000/7080	63	B	44	15,3
BSMS 600	230	50/60	235/340	1,15/1,65	10	1400/1670	8000/9540	65	B	44	15,6
BSTS 250-2K	380	50/60	150/180	0,48/0,40	-	2900/3400	2200/2580	61	B	44	6,3
BSTS 250	380	50/60	100/120	0,62/0,46	-	1450/1750	1200/1450	45	B	44	6
BSTS 300	380	50/60	130/155	0,65/0,50	-	1450/1750	2000/2400	48	B	44	7
BSTS 350	380	50/60	135/160	0,65/0,51	-	1470/1720	3250/3800	53	B	44	8,2
BSTS 400	380	50/60	150/180	0,66/0,55	-	1450/1700	4500/5275	56	B	44	9
BSTS 450	380	50/60	155/185	0,66/0,55	-	1450/1700	5000/6000	60	B	44	9,6
BSTS 500	380	50/60	160/190	0,67/0,55	-	1450/1700	5500/6450	62	B	44	11
BSTS 550	380	50/60	165/195	0,67/0,56	-	1400/1575	6000/6750	63	B	44	15,3
BSTS 600	380	50/60	170/200	0,68/0,57	-	1400/1650	8000/9400	65	B	44	15,6

The sound level is measured at a distance of 3 m in open field condition.

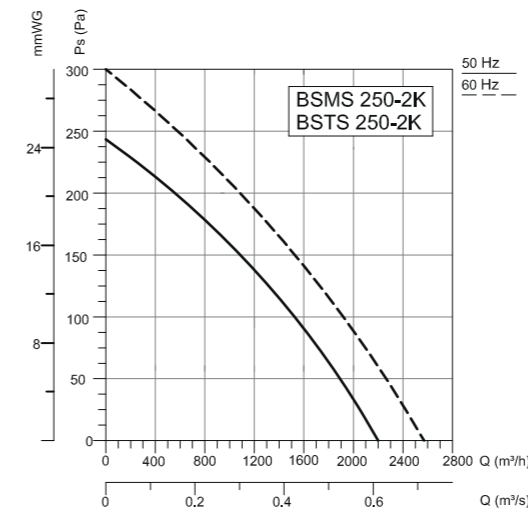

Frequency	Tot	63	125	250	500	1000	2000	4000	8000	Hz
L _{WA} Surrounding	82	56	67	76	75	77	75	70	64	dB(A)

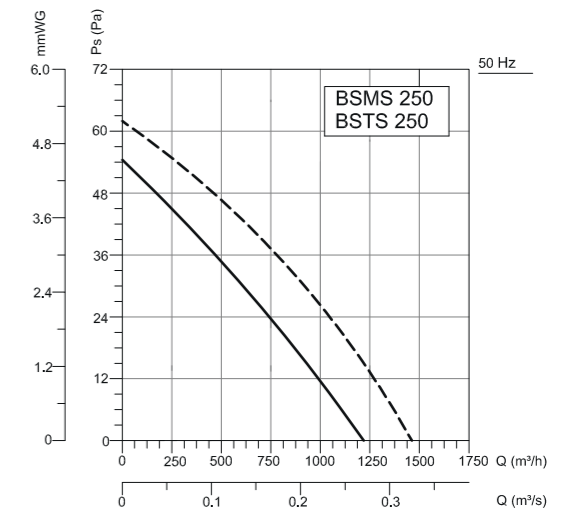

Frequency	Tot	63	125	250	500	1000	2000	4000	8000	Hz
L _{WA} Surrounding	66	34	48	55	60	61	60	55	47	dB(A)

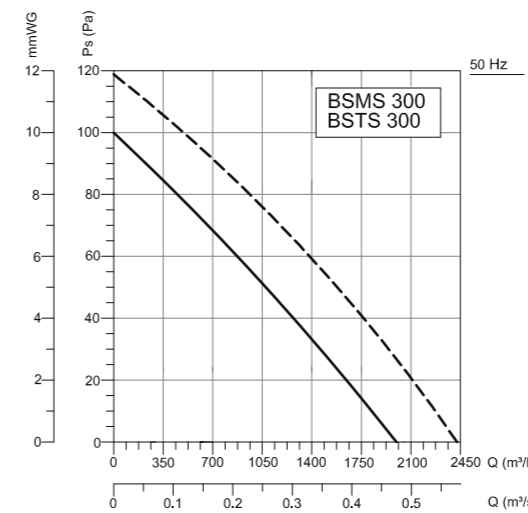

Frequency	Tot	63	125	250	500	1000	2000	4000	8000	Hz
L _{WA} Surrounding	69	43	54	60	62	64	61	56	51	dB(A)

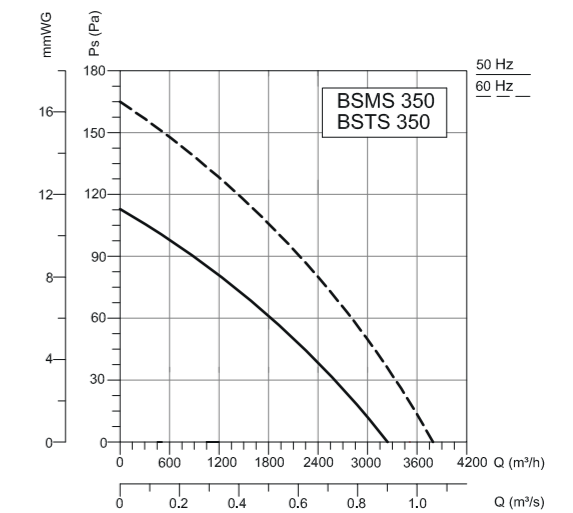

Frequency	Tot	63	125	250	500	1000	2000	4000	8000	Hz
L _{WA} Surrounding	74	40	59	58	65	71	65	63	54	dB(A)

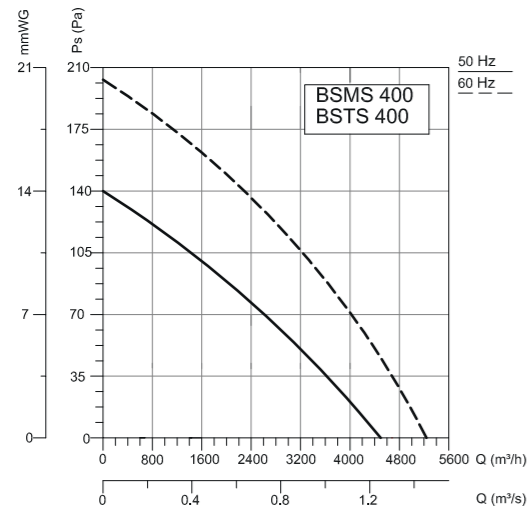

Frequency	Tot	63	125	250	500	1000	2000	4000	8000	Hz
L _{WA} Surrounding	77	49	62	63	70	73	70	65	56	dB(A)

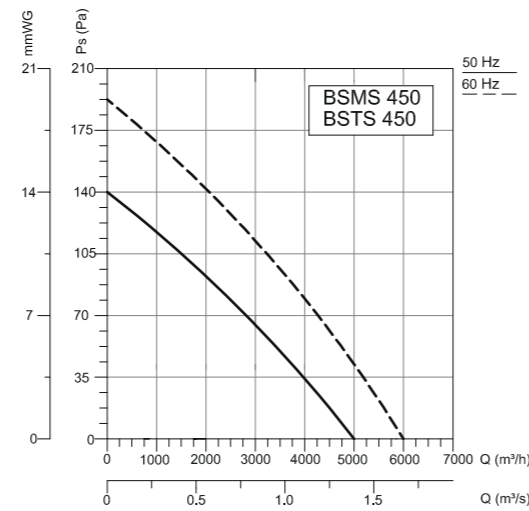

Frequency	Tot	63	125	250	500	1000	2000	4000	8000	Hz
L _{WA} Surrounding	81	48	67	64	70	77	76	71	63	dB(A)

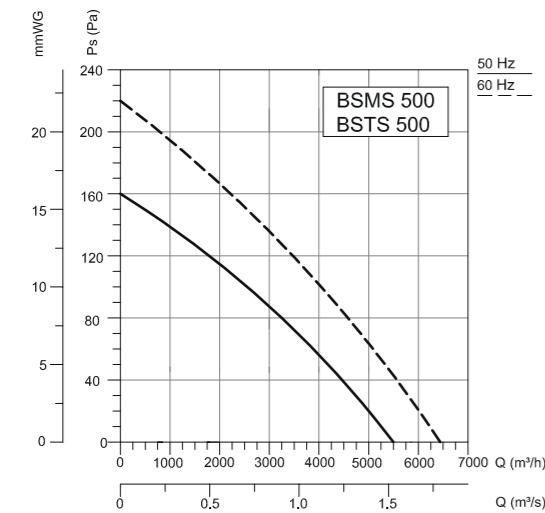

Frequency	Tot	63	125	250	500	1000	2000	4000	8000	Hz
L _{WA} Surrounding	83	50	69	70	74	78	77	73	66	dB(A)

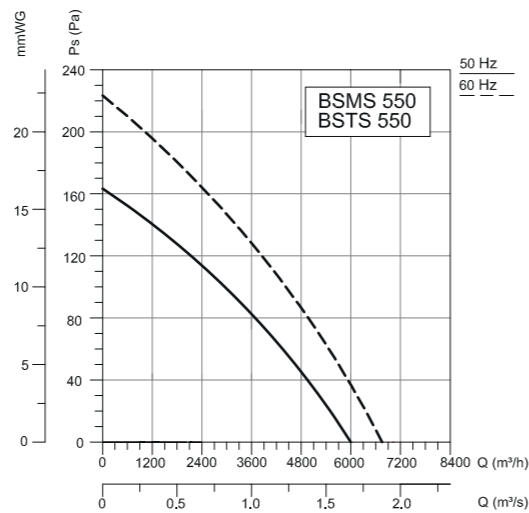

Frequency	Tot	63	125	250	500	1000	2000	4000	8000	Hz
L _{WA} Surrounding	85	57	70	74	78	80	78	74	67	dB(A)

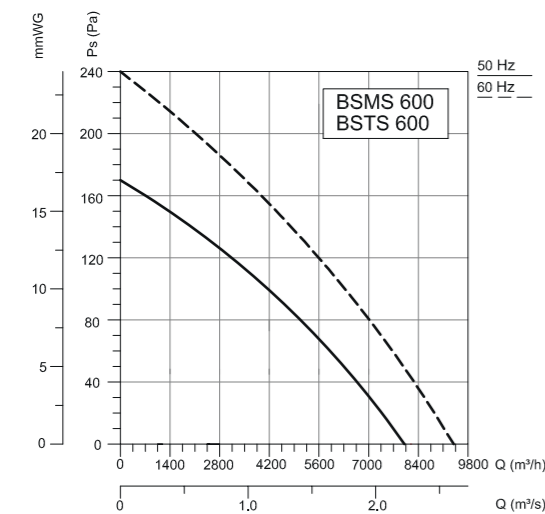

Frequency	Tot	63	125	250	500	1000	2000	4000	8000	Hz
L _{WA} Surrounding	86	54	69	73	78	82	79	76	72	dB(A)



BSV INDUSTRIAL VENTILATORS

Fan Components and Material Properties

Automatic right-to-left axis, up-down axis with manual rotation capability to cool any desired direction. It can be mounted on wall with BSV-D wall type.

Fan Structure

The aerodynamically optimized wings provide high efficiency.

Speed Control

3-speed speed switch is available.

Usage Areas

Greenhouses, warehouses, paint shops, textile workshops, factories etc. Can be used in places.

Technical Drawing and Tables

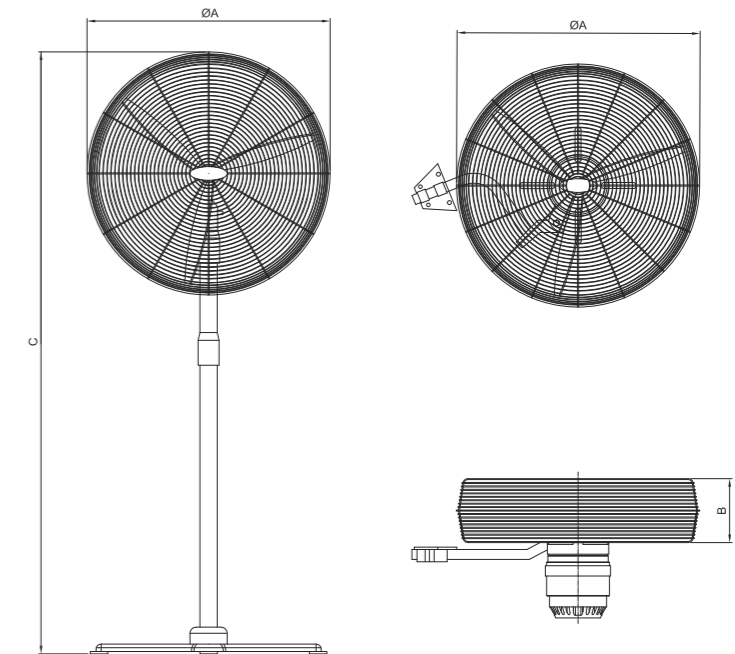

TYPE	A	B	C
BSV 500	500	120	1900
BSV 600	600	120	1900
BSV 750	720	120	1950
BSV-D 500	500	120	-
BSV-D 600	600	120	-
BSV-D 750	750	120	-

Dimensions are in (mm)

TYPE	VOLTAGE	FREQUENCY	POWER	SPEED	AIR FLOW	WEIGHT
	V	Hz	W	r.p.m	m ³ /h	kg
BSV 500	230	50	120	1400	7000	19
BSV 600	230	50	150	1400	11000	24
BSV 750	230	50	350	1400	17400	27
BSV-D 500	230	50	120	1400	7000	19
BSV-D 600	230	50	150	1400	11000	24
BSV-D 750	230	50	350	1400	17400	27

Sound Level Measured from 3m distance in room condition.



BB

AXIAL FANS

Fan Components and Material Properties

Body and fan are made of electrostatic powder coated sheet steel. The motor and fan impeller are connected to the main body by steel carriers. Easily mounted on windows and wall. Provides strong airflow thanks to ideal blade angles.

Benefits

Provides strong airflow thanks to ideal blade angles. It has a compact design.

Speed Control

Optional control devices can be provided.
* Speed control can be done with linear voltage regulator. (see BSC accessory)

Usage Areas

It is used in the kitchen, bathroom, office and workplaces where smelly, smoke-like air is required to be discharged.

Technical Drawing and Tables

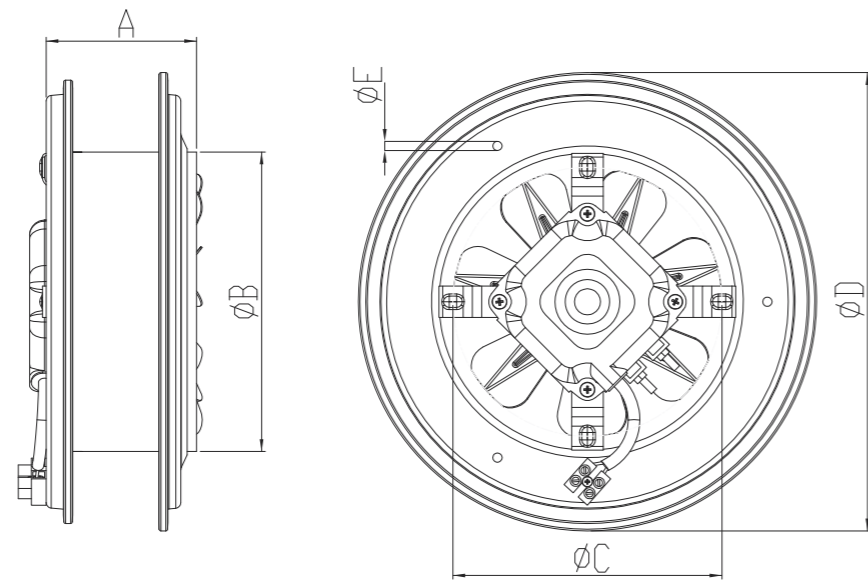

TYPE	A (± 2)	B	C	D	E
BB 160	82	162	148	236	5
BB 200	82	202	178	282	5
BB 250	82	248	234	332	5
BB 300	82	298	284	380	5

Dimensions are in (mm)

TYPE	VOLTAGE	FREQUENCY	POWER	CURRENT	SPEED	AIR FLOW	SOUND PRESSURE	INSULATION CLASS	PROTECTION CLASS	WEIGHT	PIECES IN BOX
	V	Hz	W	(A)	r.p.m	m ³ /h	dB(A)	Ins.cl.	IP	kg	AD
BB 160	230	50/60	25	0,15	1450	450	40	B	44	1,5	8
BB 200	230	50/60	28	0,15	1250	780	42	B	44	1,7	8
BB 250	230	50/60	48	0,33	1450	890	46	B	44	2,5	8
BB 300	230	50/60	50	0,33	1350	1150	50	B	44	2,8	8

The sound level is measured at a distance of 3 m in open field condition.

Accessories



BSC



BK

AXIAL FANS

Fan Components and Material Properties

Body and fan are made of electrostatic powder coated sheet steel. The motor and fan impeller are connected to the main body by steel carriers. Easily mounted on windows and wall. Provides strong airflow thanks to ideal blade angles.

Benefits

Provides strong airflow thanks to ideal blade angles. Covered structure with unwanted air, dust, rain, etc. prevents entry. It has a compact design.

Speed Control

Optional control devices can be provided.
* Speed control can be done with linear voltage regulator. (see BSC accessory)

Usage Areas

It is used in the kitchen, bathroom, office and workplaces where smelly, smoke-like air is required to be discharged.

Technical Drawing and Tables

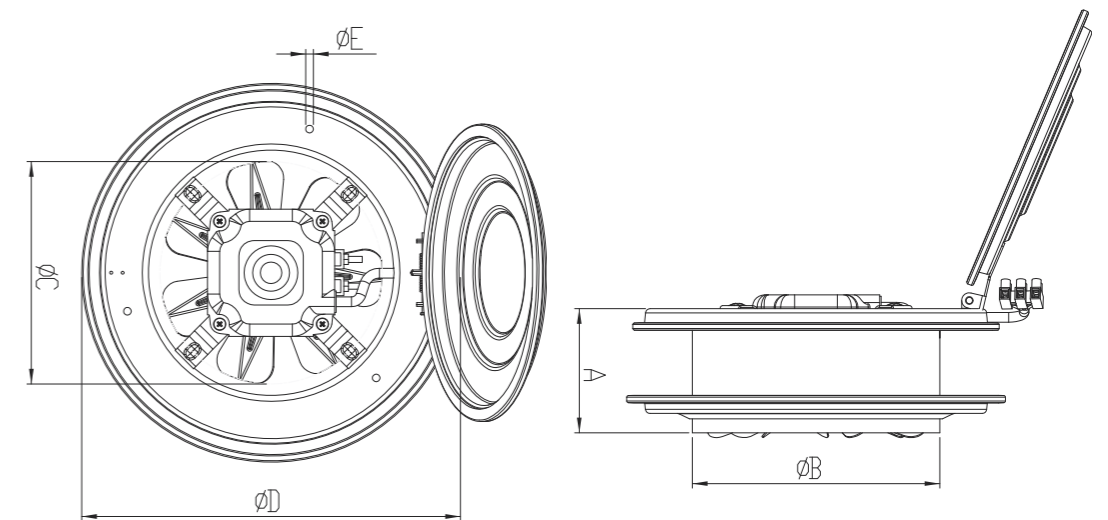

TYPE	A (± 2)	B	C	D	E
BK 160	100	162	148	236	5
BK 200	100	202	178	282	5
BK 250	100	248	234	332	5
BK 300	100	298	284	380	5

Dimensions are in (mm)

TYPE	VOLTAGE	FREQUENCY	POWER	CURRENT	SPEED	AIR FLOW	SOUND PRESSURE	INSULATION CLASS	PROTECTION CLASS	WEIGHT	PIECES IN BOX
	V	Hz	W	(A)	r.p.m	m ³ /h	dB(A)	Ins.cl.	IP	kg	AD
BK 160	230	50/60	25	0,15	1450	450	40	B	44	1,8	8
BK 200	230	50/60	28	0,15	1250	780	42	B	44	2,1	8
BK 250	230	50/60	48	0,33	1450	890	46	B	44	3,1	8
BK 300	230	50/60	50	0,33	1350	1150	50	B	44	2,8	8

The sound level is measured at a distance of 3 m in open field condition.

Accessories



BSC

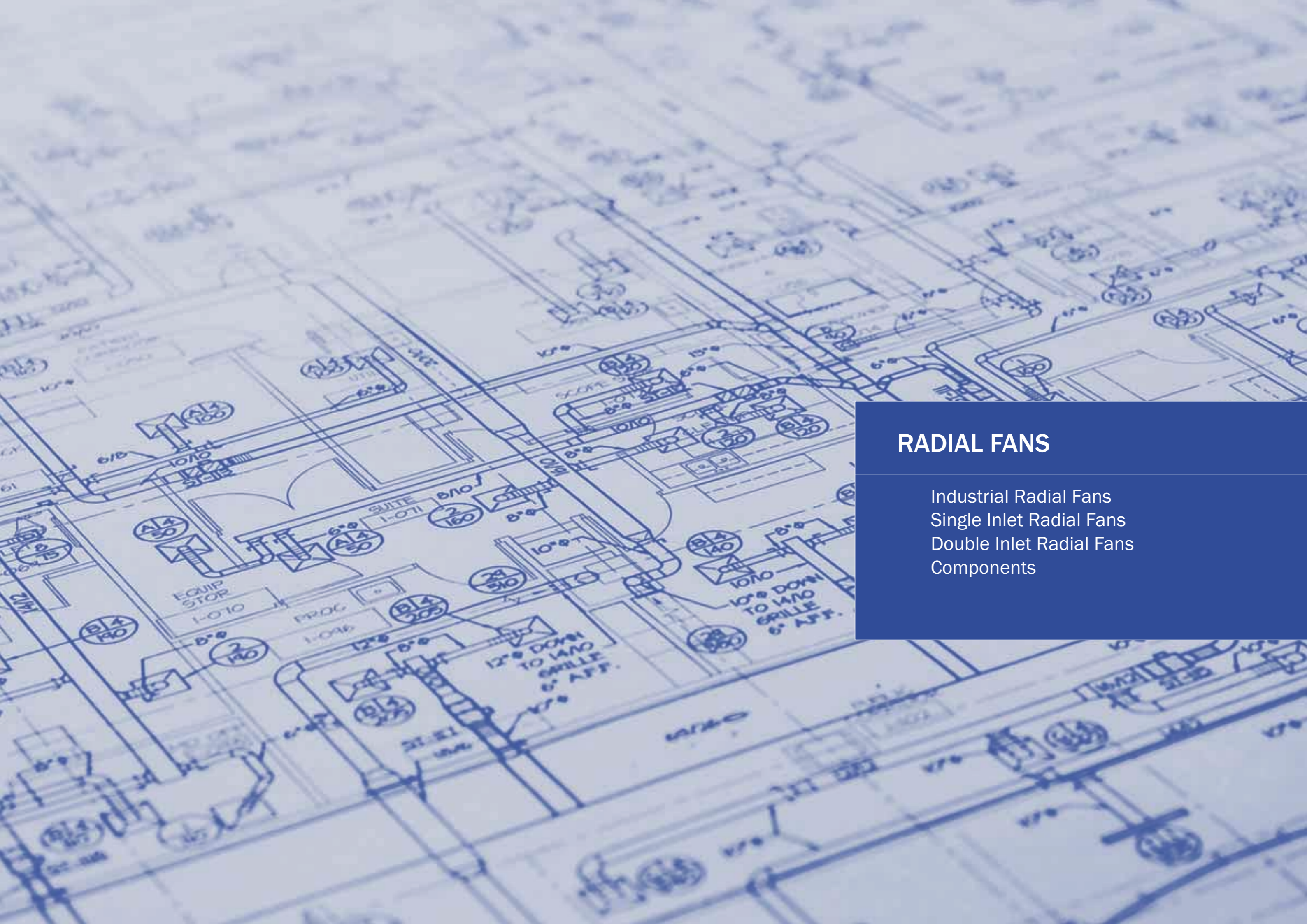

RADIAL FANS

Industrial Radial Fans
Single Inlet Radial Fans
Double Inlet Radial Fans
Components

RADIAL FANS

Radial fans with their high-pressure properties and high efficiency, are suitable for use in applications like duct fans, air handling units, heating-cooling applications and industrial ventilation.

IMPELLER TYPE

FORWARD CURVED



BACKWARD CURVED



HOUSING TYPE

PLASTIC CASED



METAL CASED



ALUMINIUM CASED



MOTOR TYPE

EXTERNAL ROTOR MOTOR



INTERNAL ROTOR MOTOR



SUCTION POSITION

SINGLE INLET



DOUBLE INLET





ALÇ

INDUSTRIAL RADIAL FANS / Backward Curved

Fan Components and Material Properties

The body is made of high quality galvanized sheet steel. The ALÇ 315-400 models are made of high quality galvanized steel which is resistant to corrosion. ALÇ 450-560 models are made of aluminum sheet. All models have an asynchronous motor and have air flow at max.120°C.

Fan Structure

Single suction, low pressure radial fan type. The fan blades are aerodynamically curved and provide regular flow. The fans are composed of backward sloping and infrequently arranged fins.

Benefits

With the screwing system, the frame can be easily rotated to the desired shooting position.

They are able to provide high air flow rates at nominal static pressures. Thanks to the aerodynamic wing structure, they work quietly. Speed can be adjusted with speed control devices. The motor housing protects the electric motor from external influences.

Speed Control

Optional control devices can be provided. Speed control with frequency inverter can be done in 3-phase products (see BSC-F accessory)

Usage Areas

In factories, workshops and factories etc. ventilation is used where required. It is suitable for smoke extraction and exhaust air exhaust filter.

Technical Drawing and Tables

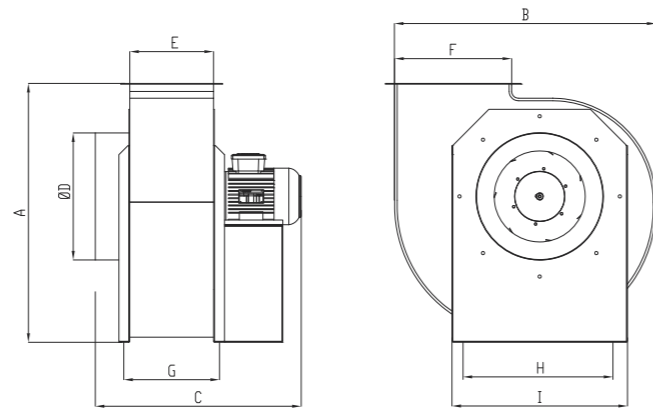

TYPE	A	B	C	D	E	F	G	H	I
ALÇ 315	560	567	490	250	185	256	219	320	380
ALÇ 355	645	639	495	300	192	286	224	359	419
ALÇ 400	714	720	525	350	211	316	245	424	484
ALÇ 450	792	810	565	350	232	356	264	465	525
ALÇ 500	889	906	660	427	290	400	322	524	584
ALÇ 560	996	1015	745	470	318	448	349	604	704

Dimensions are in (mm)

TYPE	VOLTAGE	FREQUENCY	POWER	CURRENT	CAPACITOR	SPEED	AIR FLOW	SOUND PRESSURE	INSULATION CLASS	PROTECTION CLASS	WEIGHT
TYPE	V	Hz	kW	(A)	(µF)	r.p.m	m ³ /h	dB(A)	Ins.cl.	IP	kg
ALÇ 315M	230	50	0,25	2,1	10	1380	1800	37-29	F	55	41
ALÇ 355M	230	50	0,25	2,1	10	1380	2800	41-33	F	55	53
ALÇ 400M	230	50	0,37	3,4	15	1390	4000	42-34	F	55	64
ALÇ 450M	230	50	0,55	4,5	20	1365	5300	45-37	F	55	70
ALÇ 500M	230	50	1,1	7,5	35	1410	8000	49-42	F	55	90
ALÇ 560M	230	50	2,2	14,2	50	1420	10000	52-44	F	55	103
ALÇ 315T	380	50	0,25	0,87	-	1380	1800	37-29	F	55	41
ALÇ 355T	380	50	0,25	0,87	-	1380	2800	41-33	F	55	53
ALÇ 400T	380	50	0,37	1,2	-	1390	4000	42-34	F	55	64
ALÇ 450T	380	50	0,55	1,6	-	1365	5300	45-37	F	55	70
ALÇ 500T	380	50	1,1	2,6	-	1410	8000	49-42	F	55	90
ALÇ 560T	380	50	2,2	4,9	-	1420	10000	52-44	F	55	103

The sound level is measured at a distance of 4-10 m in open field condition.

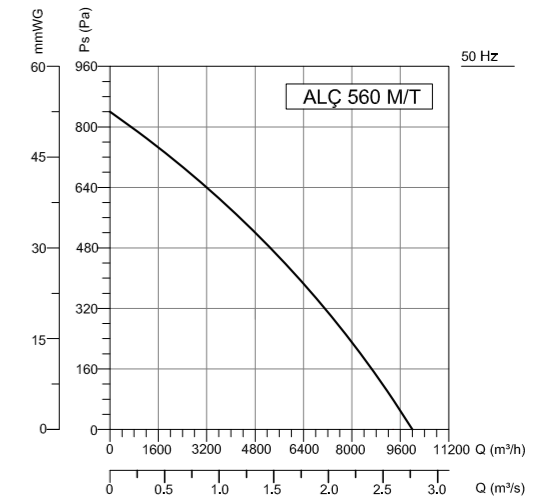
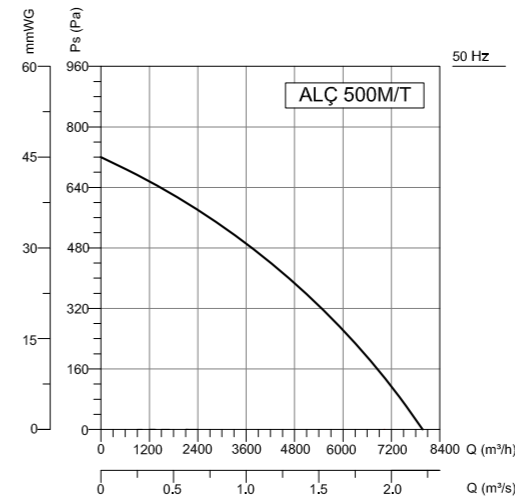
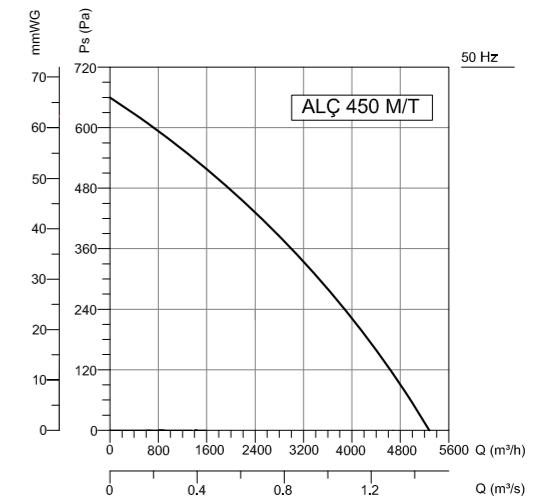
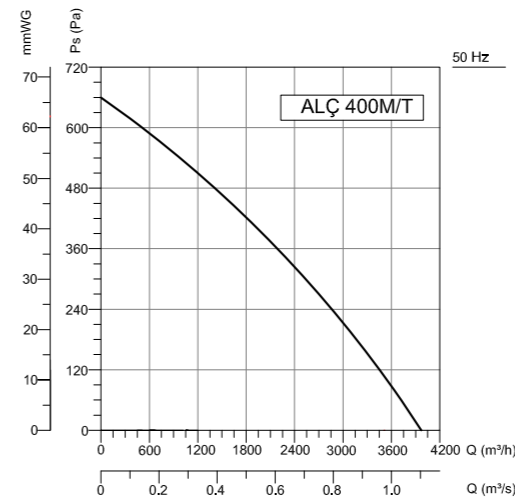
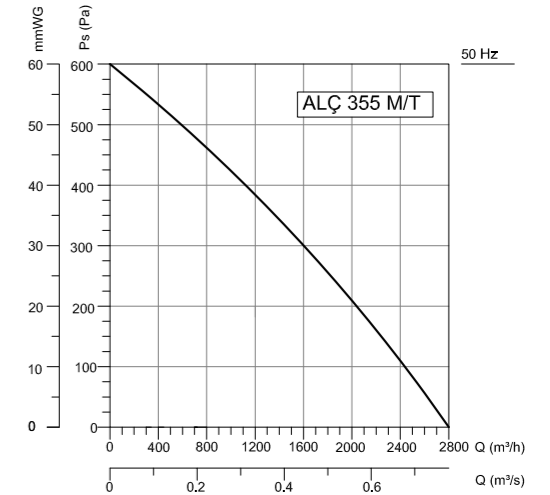
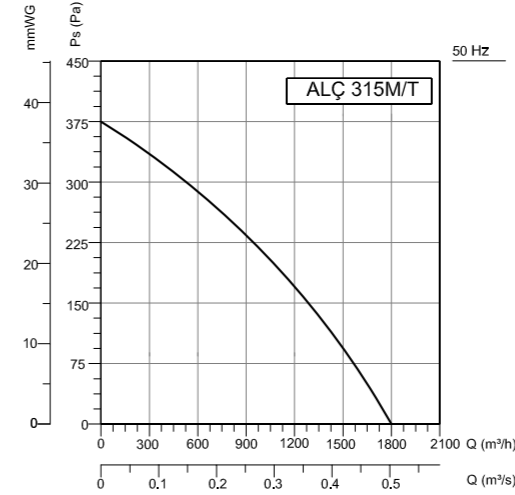

Accessories



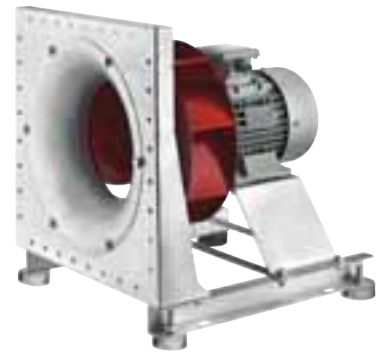

BPF

INDUSTRIAL RADIAL FANS / PLUG / Backward Curved

Fan Components and Material Properties

The body is made of high quality galvanized steel which is resistant to corrosion. Fan blades are manufactured from electrostatic powder coated, backward curved and streamlined. The motor and fan impeller are connected to the main body by a steel base. All models have asynchronous motor. The motors are out of the air flow and can be optionally supplied without motors.

Fan Structure

The fan blades have optimum aerodynamic design to provide backward curved and regular flow. Made of welded fan blades.

Benefits

BPF (Spool Plug Fan) has a compact design with base and motor. Aerodynamic and acoustic sound insulation are at optimum value. Easy to clean and can be shot from all directions. Speed adjustable with speed control devices.

Speed Control

Optional control devices can be provided. Speed control with frequency inverter can be done in 3-phase products (see BSC-F accessory)

Usage Areas

In industrial ventilation applications, air conditioners etc. used in places.

Technical Drawing and Tables

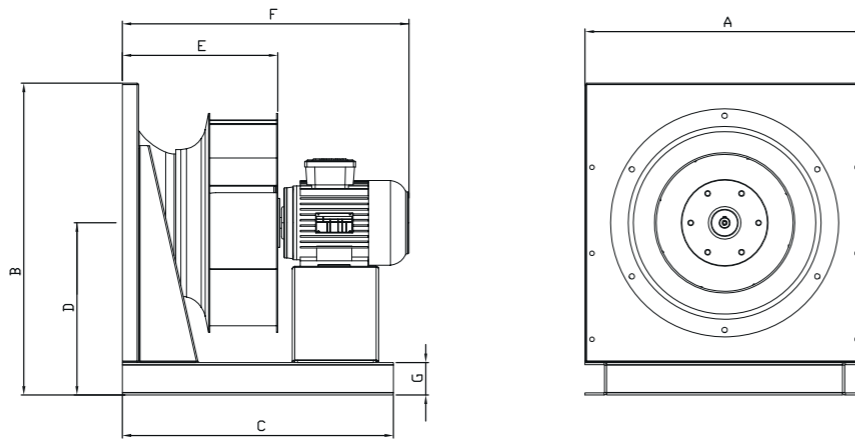

TYPE	A	B	C	D	E	F	G
BPF 280 (0,75)	390	440	450	245	210	435	50
BPF 315 (1,5)	430	490	480	275	235	480	60
BPF 355 (3)	470	530	500	295	260	565	60
BPF 400 (4)	515	575	600	318	285	650	60
BPF 450 (7,5)	582	642	600	351	315	705	60
BPF 500 (3)	645	705	650	383	350	680	60
BPF 560 (4)	715	775	700	418	385	705	60
BPF 630 (7,5)	800	863	865	463	403	850	60

Dimensions are in (mm)

TYPE	VOLTAGE	FREQUENCY	POWER	SPEED	AIR FLOW	PRESSURE
TYPE	V	Hz	kW	r.p.m	m ³ /h	dB(A)
BPF 280 (0,75)	230/380	50	0,75	2800	2500	550
BPF 315 (1,5)	230/380	50	1,5	2800	4000	700
BPF 355 (3)	380	50	3	2800	6000	800
BPF 400 (4)	380	50	4	2800	8000	800
BPF 450 (7,5)	380	50	7,5	2800	12000	900
BPF 500 (3)	380	50	3	1400	10000	380
BPF 560 (4)	380	50	4	1400	14000	400
BPF 630 (7,5)	380	50	7,5	1400	20000	800

Sound Level Measured from 3m distance in room condition.

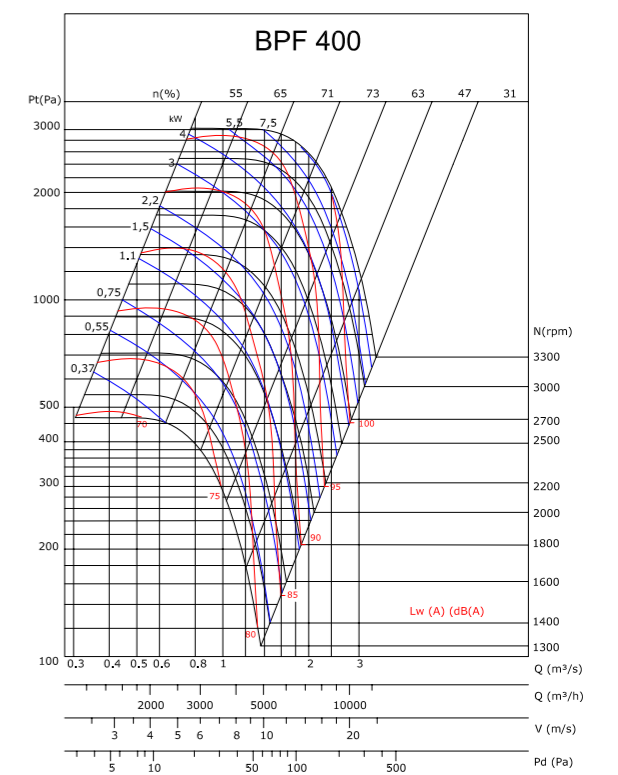
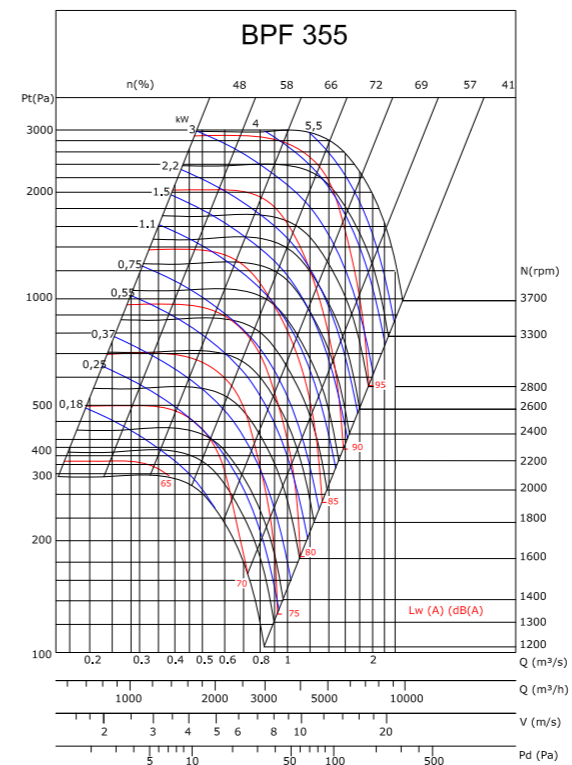
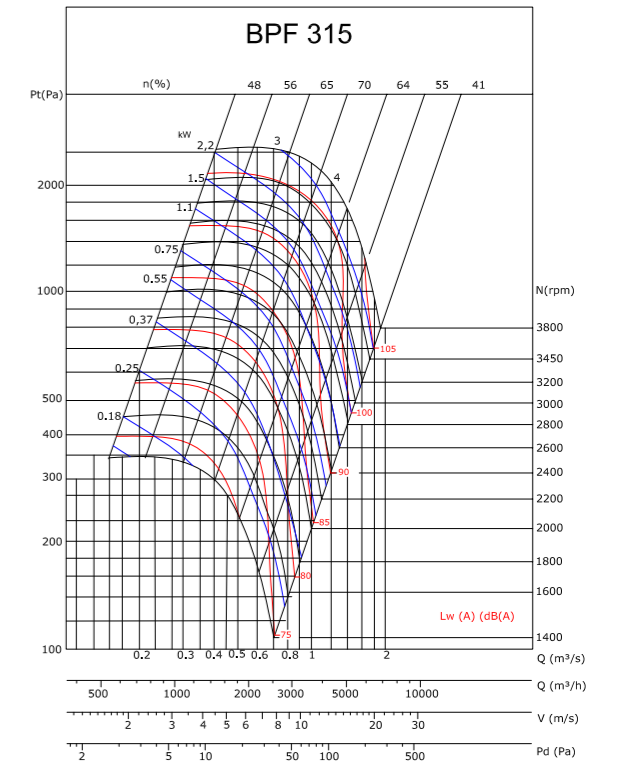
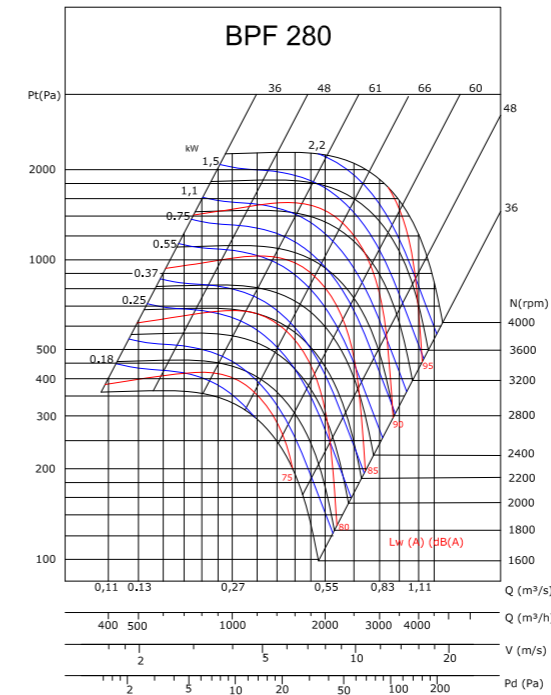

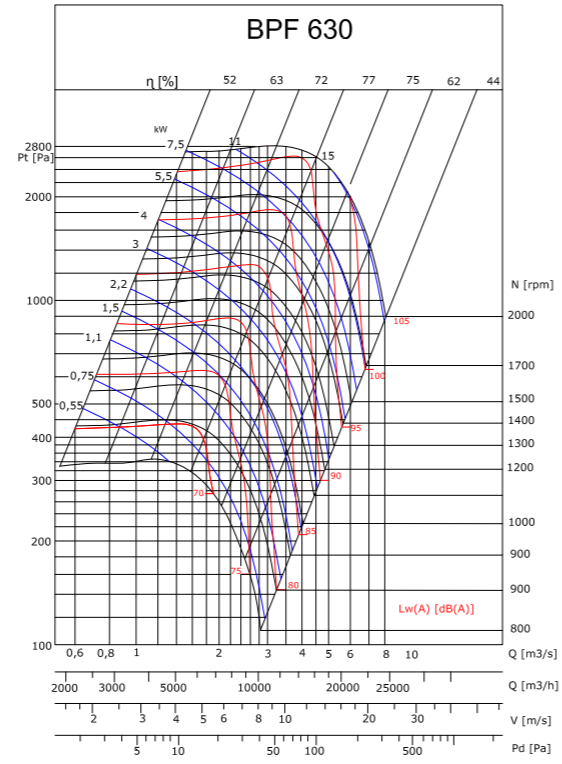
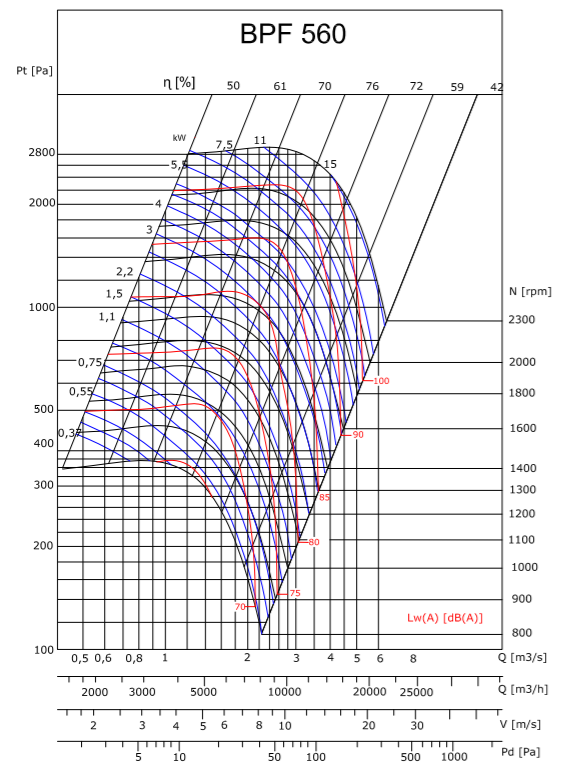
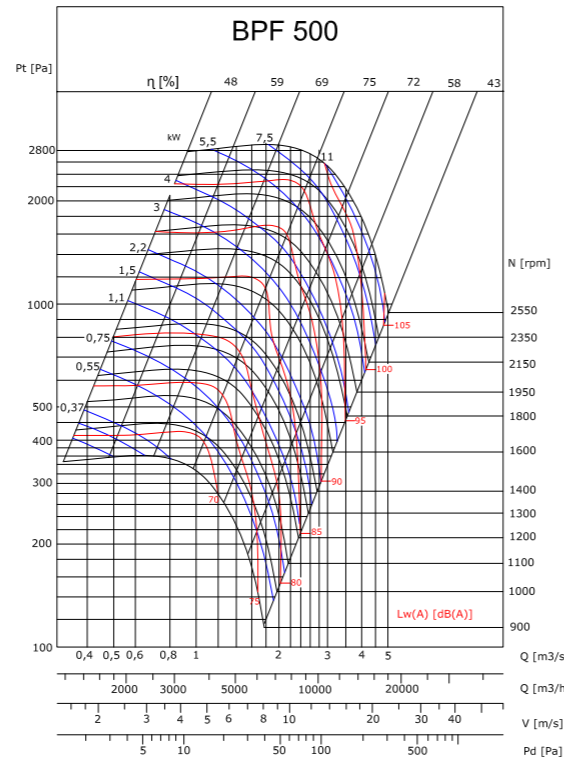
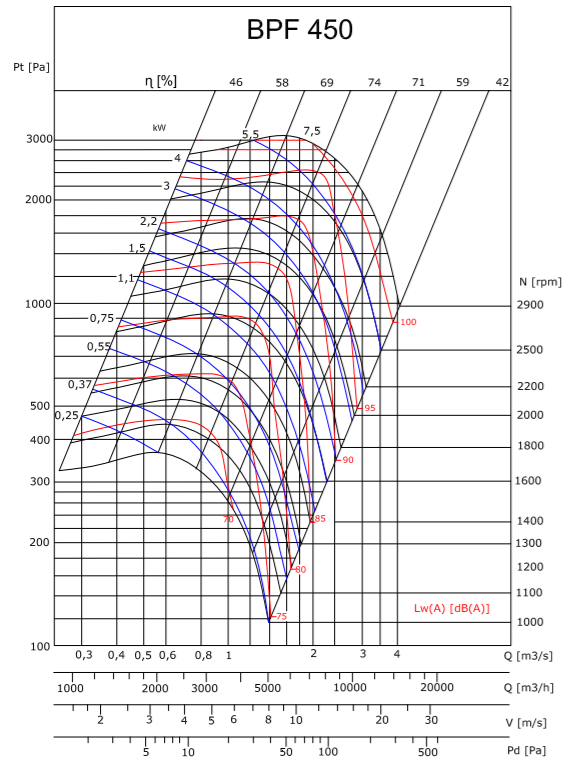

BGSS

INDUSTRIAL RADIAL FANS / Backward Curved

Fan Components and Material Properties

Body and fan are made of DKP steel sheet with electrostatic powder coating. All models have asynchronous motor. It is capable of carrying air at a temperature of Max.120°C.

Speed Control

Optional control devices can be provided. Speed control with frequency inverter can be done in 3-phase products (see BSC-F accessory)

Fan Structure

Single suction, low pressure, radial fan type. The fan blades are aerodynamically curved and provide regular flow. Made of welded fan blades.

Usage Areas

In the extraction of clean air, industrial areas, domestic and industrial air conditioning system, mine, tunnel ventilation, garbage storage and stables etc. It is used in areas such as the decomposition of odorous gases and toxic gases. It is suitable for smoke extraction and exhaust air exhaust filter.

Benefits

They can give large amounts of air at low static pressures. Speed can be adjusted with speed control devices.

Technical Drawing and Tables

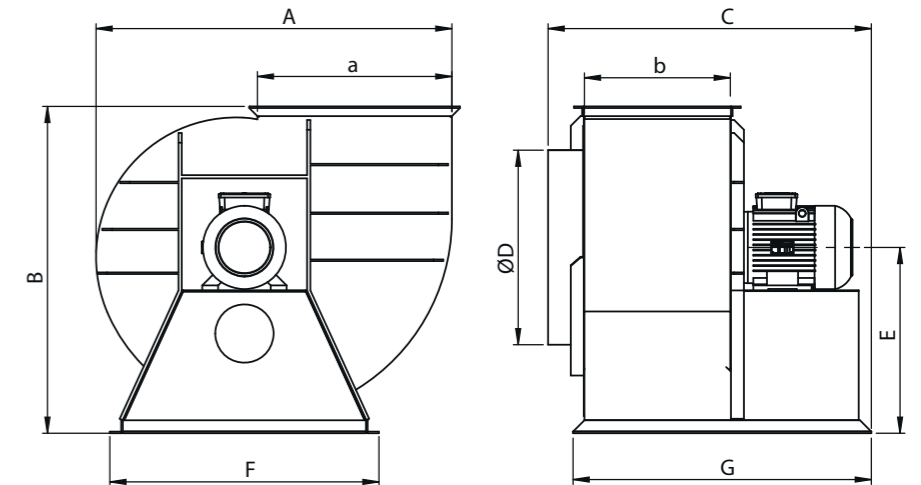

TYPE	A	B	C	D	E	F	G	Outlet frame dimensions	
								a	b
BGSS 1	515	507	474	225	291	420	445	195	185
BGSS 2	580	584	495	260	325	460	460	225	205
BGSS 3	699	680	650	310	386	560	590	335	275
BGSS 4	782	760	685	350	435	635	615	377	300
BGSS 5	872	883	771	400	520	733	696	414	320
BGSS 6	925	900	826	450	515	755	755	436	350
BGSS 7	1040	1015	886	500	602	740	825	522	396
BGSS 8	1100	1008	997	600	573	830	920	588	450
BGSS 9	1130	1080	1047	650	632	990	980	588	500
BGSS 10	1272	1205	1176	700	703	1030	1105	664	550
BGSS 11	1390	1265	1219	750	763	980	1145	786	600
BGSS 12	1450	1365	1275	800	815	1050	1275	788	600
BGSS 13	1576	1465	1275	850	847	1160	1290	826	600

Dimensions are in (mm)

Accessories



Accessories



TYPE	VOLTAGE	FREQUENCY	POWER	CURRENT	CAPACITOR	SPEED	AIR FLOW	SOUND PRESSURE	INSULATION CLASS	PROTECTION CLASS	WEIGHT
	V	Hz	kW	(A)	(μ F)	r.p.m	m ³ /h	dB(A)	Ins.cl.	IP	kg
BGSS 1M	230	50	0,25	2,1	10	1380	2500	70	F	55	67
BGSS 2M	230	50	0,55	3,3	20	1365	3500	72	F	55	78
BGSS 3M	230	50	0,75	5,4	30	1410	5000	75	F	55	91
BGSS 4M	230	50	1,5	9,8	50	1400	7000	85	F	55	104
BGSS 5M	230	50	2,2	14	60	1425	10000	88	F	55	145
BGSS 6M	230	50	3	20	60	1430	12000	92	F	55	158
BGSS 1T	380	50	0,25	0,87	-	1380	2500	70	F	55	67
BGSS 2T	380	50	0,55	1,6	-	1365	3500	72	F	55	78
BGSS 3T	380	50	0,75	1,92	-	1410	5000	75	F	55	91
BGSS 4T	380	50	1,5	3,5	-	1400	7000	85	F	55	104
BGSS 5T	380	50	2,2	4,9	-	1420	10000	88	F	55	145
BGSS 6T	380	50	3	6,7	-	1430	12000	92	F	55	158
BGSS 7T	380	50	4	8,4	-	1440	15000	95	F	55	175
BGSS 8T	380	50	5,5	11,5	-	1450	18000	98	F	55	225
BGSS 9T	380	50	7,5	16	-	1455	20000	100	F	55	240
BGSS 10T	380	50	11	21,3	-	1465	23000	102	F	55	255
BGSS 11T	380	50	15	29,4	-	1470	25000	103	F	55	325
BGSS 12T	380	50	18,5	34,5	-	1470	30000	105	F	55	375
BGSS 13T	380	50	22	43	-	1475	40000	105	F	55	410

The sound level is measured at a distance of 3 m in open field condition.

Fan Inlet-Outlet Position

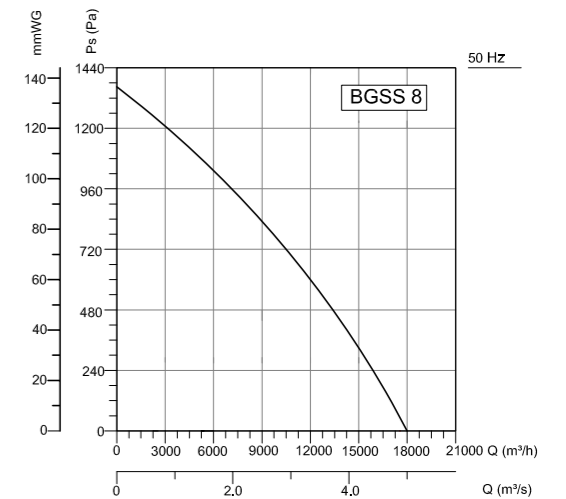
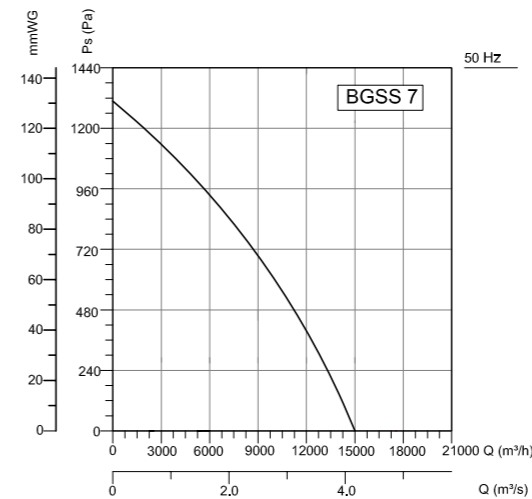
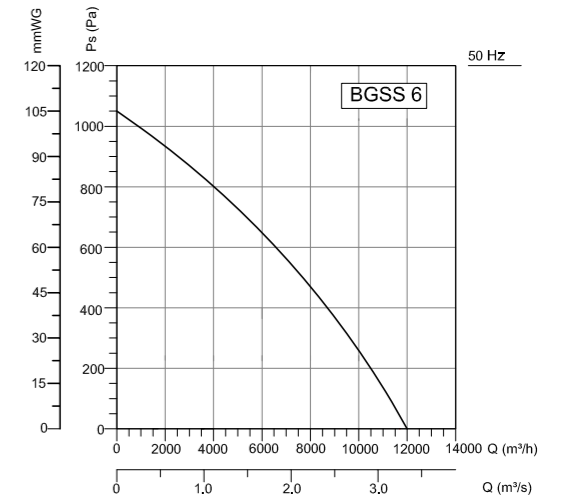
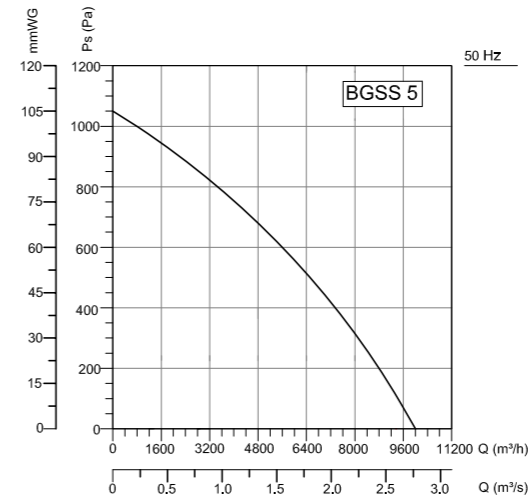
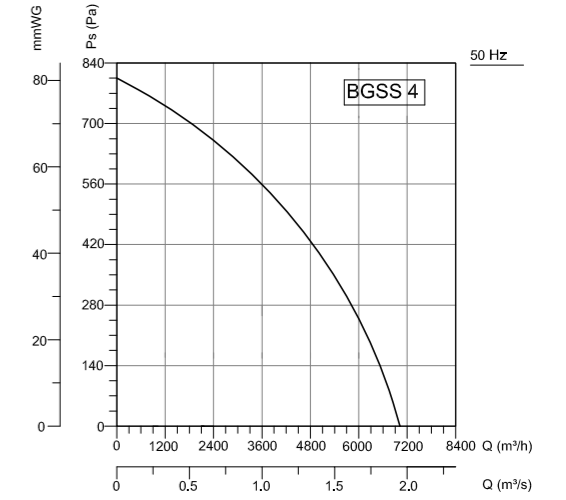
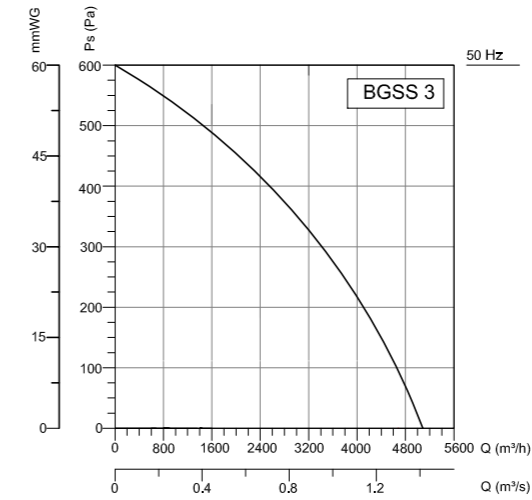
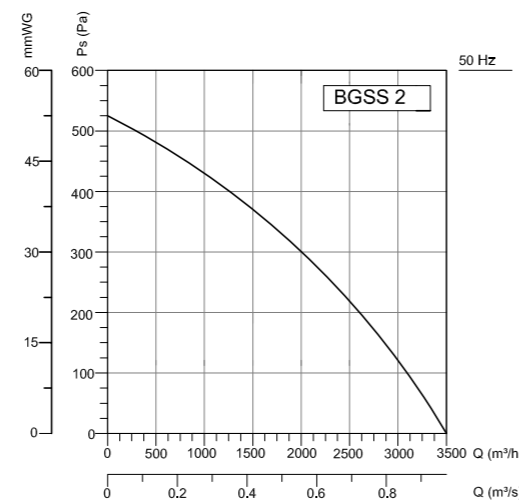
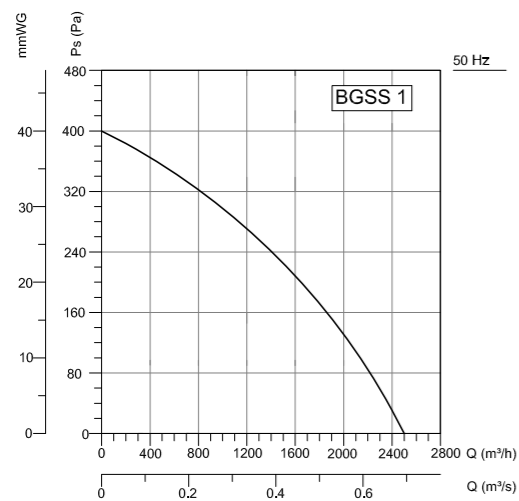
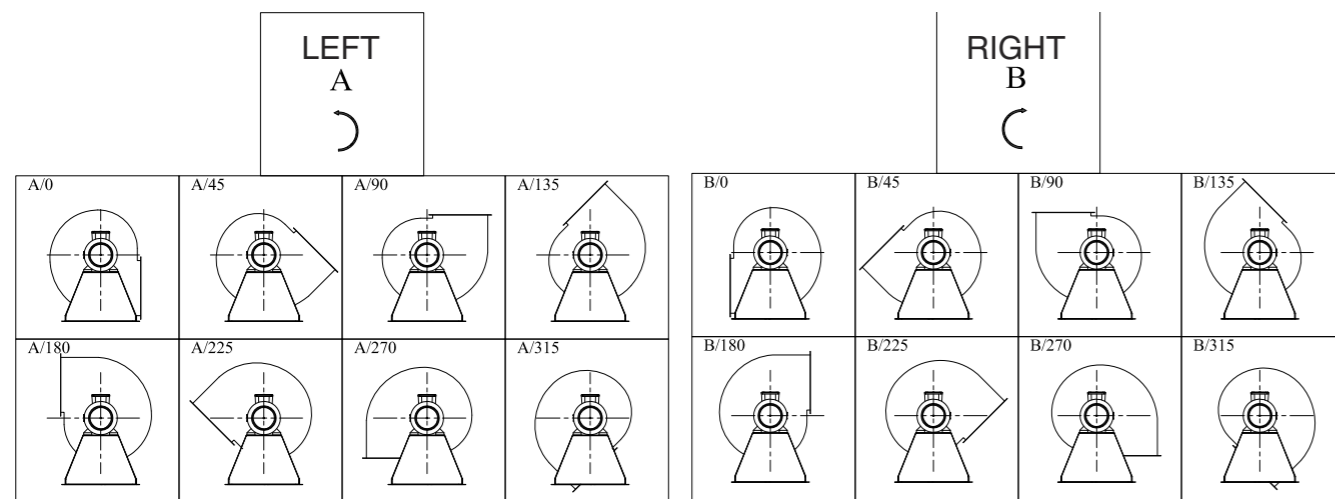

ALR

INDUSTRIAL RADIAL FANS / Backward Curved

Fan Components and Material Properties

Body is manufactured from dkp steel sheet with electrostatic powder coating. Fans of ALR 1,2,3,4 are made of high quality galvanized steel which is resistant to corrosion. ALR 5,7,8 models are made of aluminum sheet. All models have an asynchronous motor and have air flow at max.120°C.

Fan Structure

Single suction, low pressure radial fan type. The fan blades are aerodynamically curved and provide regular flow. The fans are composed of backward sloping and infrequently arranged fins.

Benefits

With the screwing system, the frame can be easily

rotated to the desired shooting position. Vibrations are prevented by vibrations. Thanks to the aerodynamic wing structure, they work quietly. Speed can be adjusted with speed control devices. The motor housing protects the electric motor from external influences.

Speed Control

Optional control devices can be provided. Speed control with frequency inverter can be done in 3-phase products (see BSC-F accessory)

Usage Areas

In factories, workshops and factories etc. ventilation is used where required. It is suitable for smoke extraction and exhaust air exhaust filter.



Technical Drawing and Tables

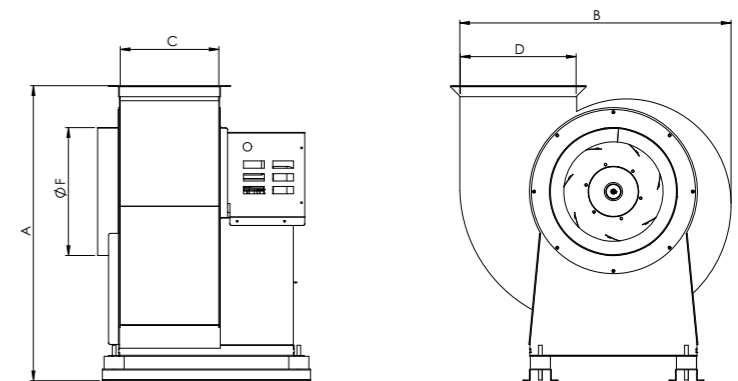

TYPE	A	B	C	D	ØF
ALR 1	590	520	200	225	250
ALR 2	650	585	220	250	280
ALR 3	725	660	245	285	300
ALR 4	810	745	275	320	350
ALR 5	900	835	300	360	400
ALR 7	1000	930	345	400	450
ALR 8	1100	1040	385	450	500

Dimensions are in (mm)

TYPE	VOLTAGE	FREQUENCY	POWER	CURRENT	CAPACITOR	SPEED	AIR FLOW	SOUND PRESSURE	INSULATION CLASS	PROTECTION CLASS
	V	Hz	kW	(A)	(µF)	r.p.m	m³/h	dB(A)	Ins.cl.	IP
ALR-1M	230	50	0,18	1,7	10	1380	1500	36-28	F	55
ALR-2M	230	50	0,25	2,1	10	1380	2300	37-29	F	55
ALR-3M	230	50	0,25	2,1	10	1380	3200	41-33	F	55
ALR-4M	230	50	0,37	3,4	15	1390	5000	42-34	F	55
ALR-5M	230	50	0,55	4,5	20	1365	6000	45-37	F	55
ALR-7M	230	50	1,1	7,5	35	1410	8000	49-42	F	55
ALR-8M	230	50	2,2	14,2	50	1420	10000	52-44	F	55
ALR-1T	380	50	0,18	0,65	-	1380	1500	36-28	F	55
ALR-2T	380	50	0,25	0,87	-	1380	2300	37-29	F	55
ALR-3T	380	50	0,25	0,87	-	1380	3200	41-33	F	55
ALR-4T	380	50	0,37	1,2	-	1390	5000	42-34	F	55
ALR-5T	380	50	0,55	1,6	-	1365	6000	45-37	F	55
ALR-7T	380	50	1,1	2,6	-	1410	8000	49-42	F	55
ALR-8T	380	50	2,2	4,9	-	1420	10000	52-44	F	55

The sound level is measured at a distance of 4-10 m in open field condition.

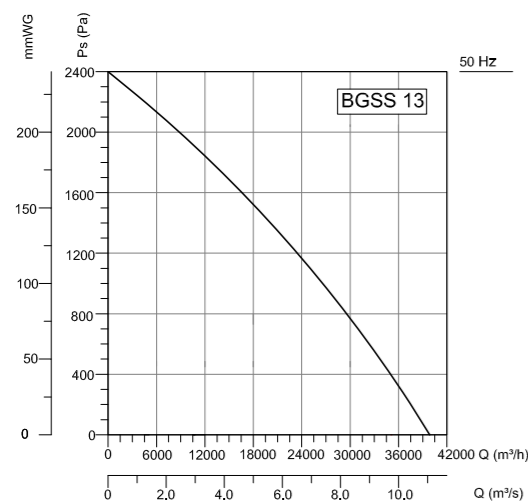
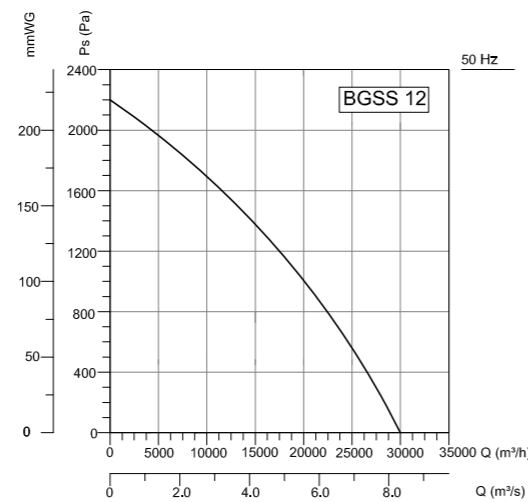
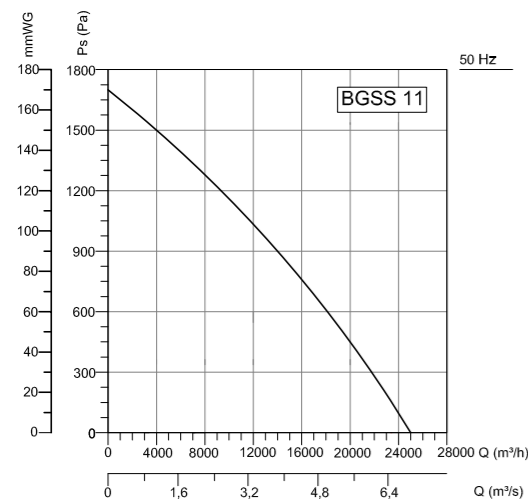
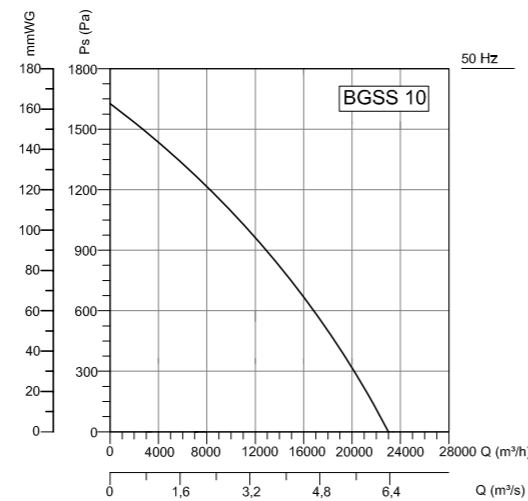
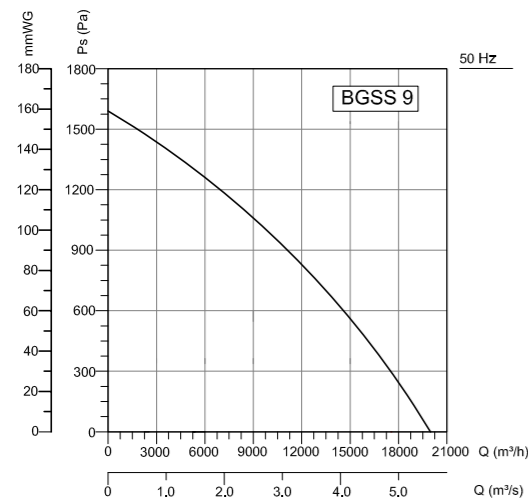

Fan Inlet-Outlet Position

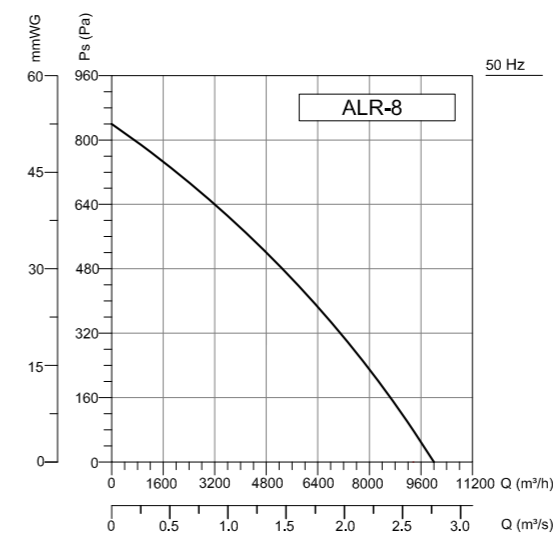
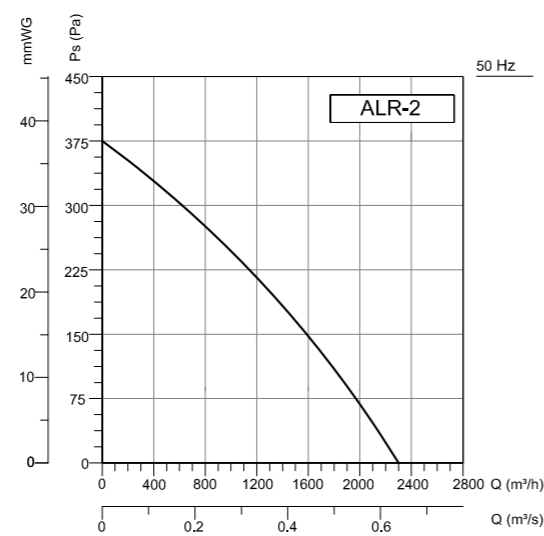
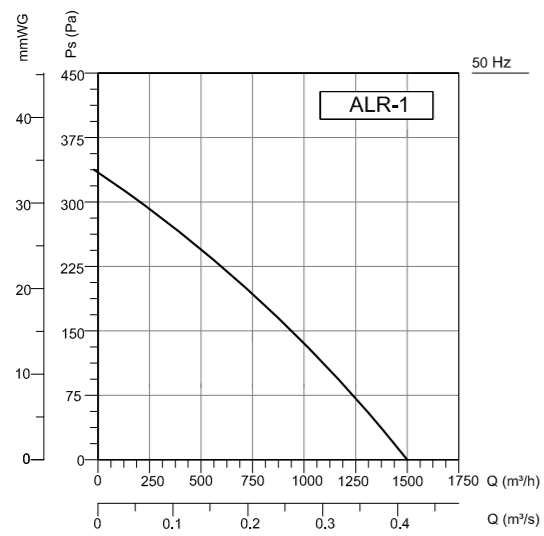
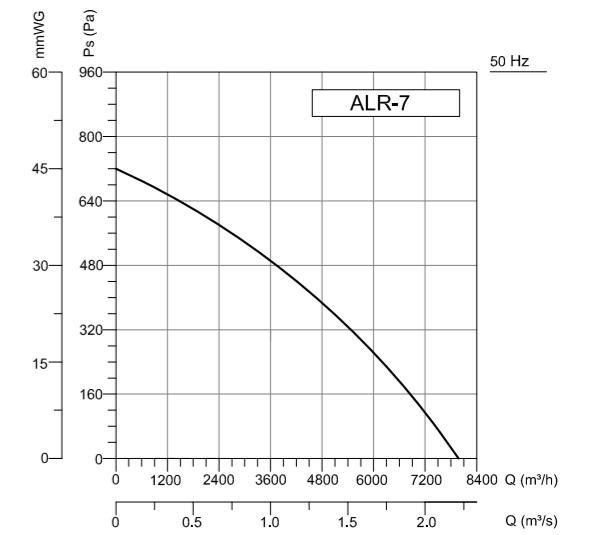
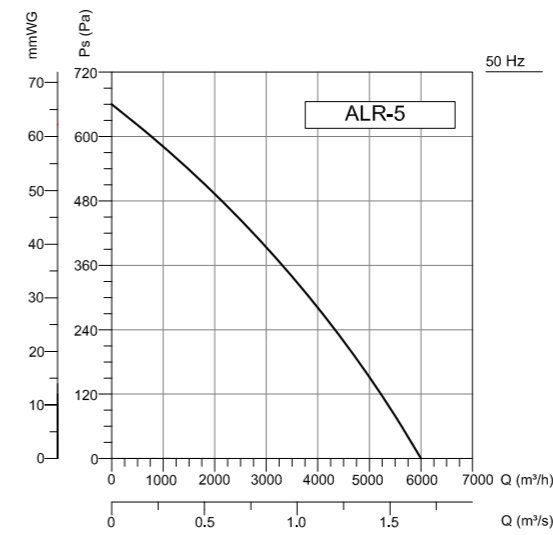
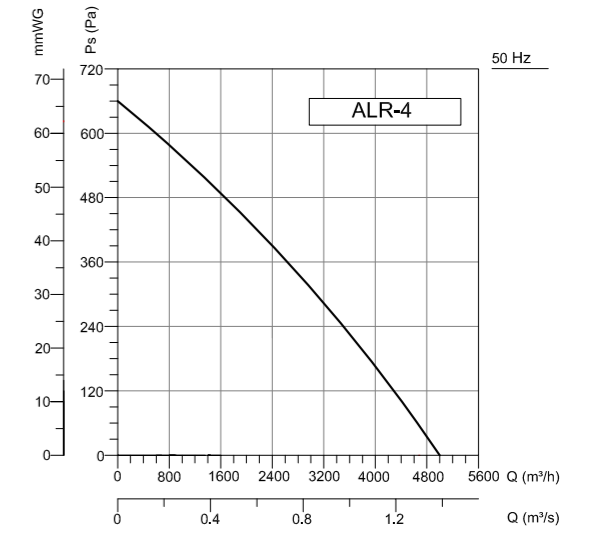
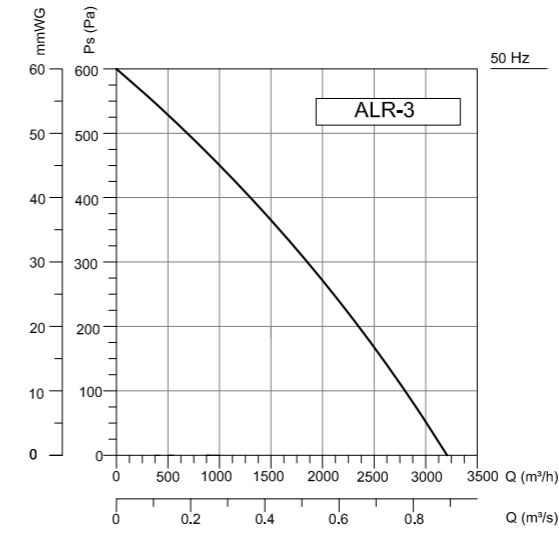
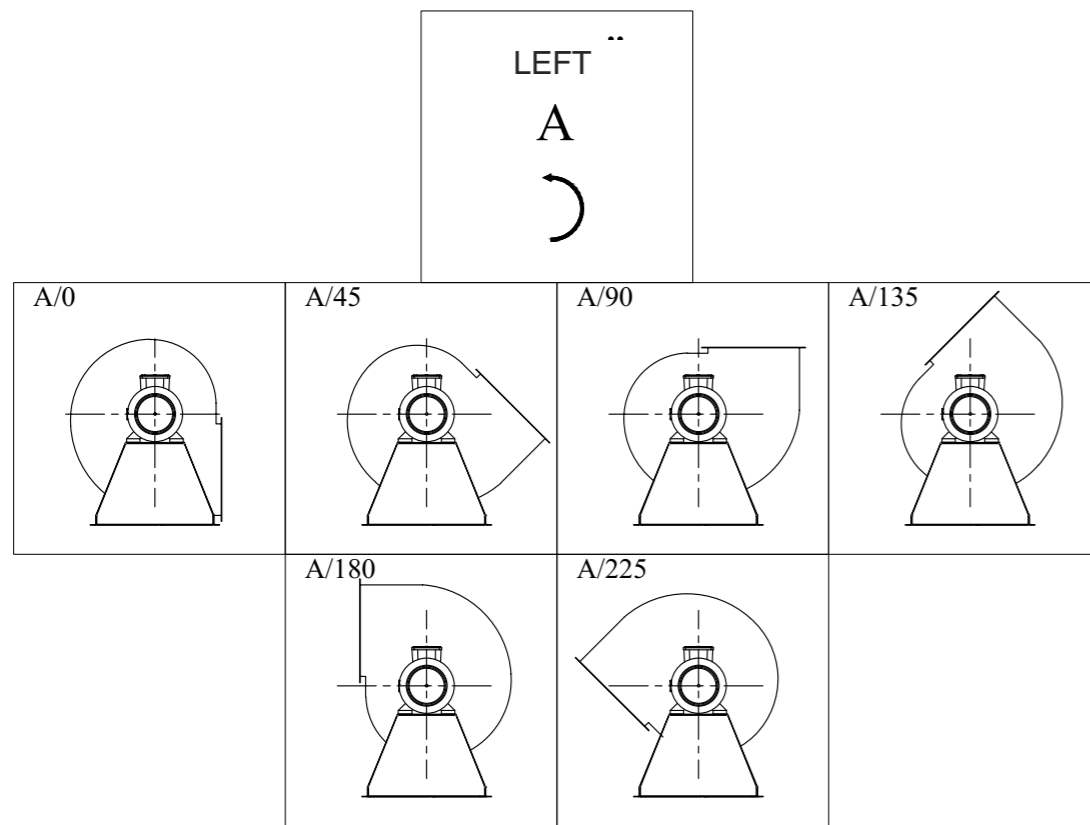

Accessories



BSC-F BYH BESB BTY BYKS BDEB



ORB

INDUSTRIAL RADIAL FANS / Forward Curved

Fan Components and Material Properties

Body and fan are made of electrostatic powder coated sheet metal. Motor and fan are connected to main body by steel base. All models have asynchronous motor. It is capable of carrying air at a temperature of Max.120°C.

Fan Structure

Single suction, medium pressure radial fan type. The fan blades are aerodynamically curved and provide regular flow.

Benefits

It provides high performance in medium and high static pressures.

Speed Control

Optional control devices can be provided. Speed control with frequency inverter can be done in 3-phase products (see BSC-F accessory)

Usage Areas

It can be used in dust collection, smoke and exhaust evacuation, fine grained material transport (marble dust, granule, plastic etc.), printing houses, paper, furniture, timber, fiberboard, ceramic and marble factories.

Technical Drawing and Tables

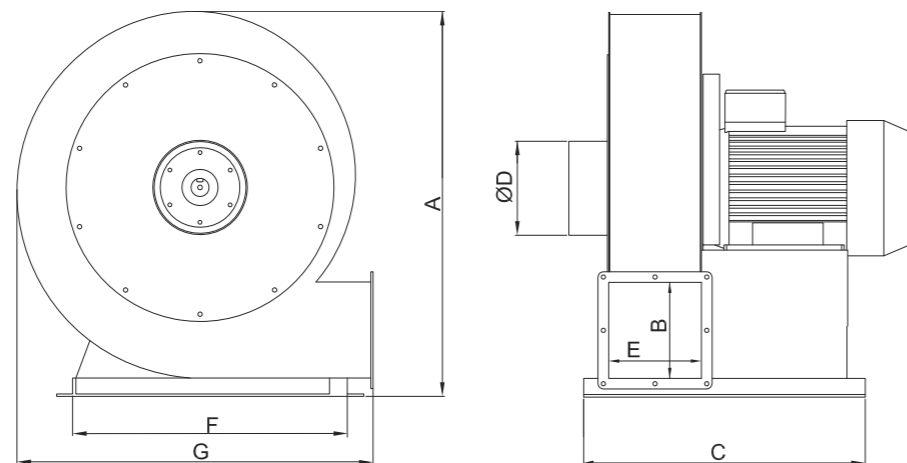

TYPE	A	B	C	D	E	F	G
ORB 1	430	95	340	120	100	320	380
ORB 2	500	95	340	120	100	370	380
ORB 3	560	95	340	120	100	390	400
ORB 4	590	110	420	150	120	450	600
ORB 5	650	110	440	150	120	450	600
ORB 6	670	140	520	150	150	450	700
ORB 7	760	140	550	150	150	510	750
ORB 8	810	140	600	150	150	630	800
ORB 9	830	140	640	180	150	630	850

Dimensions are in (mm)

Accessories

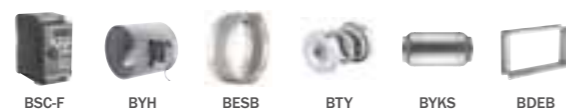

TYPE	VOLTAGE	FREQUENCY	POWER	CURRENT	CAPACITOR	SPEED	AIR FLOW	SOUND PRESSURE	INSULATION CLASS	PROTECTION CLASS	WEIGHT
	V	Hz	kW	(A)	(µF)	r.p.m	m³/h	dB(A)	Ins.cl.	IP	kg
ORB 1M	230	50	0,37	2,5	15	2800	950	56	F	55	30
ORB 2M	230	50	0,75	5	30	2760	1000	59	F	55	35
ORB 3M	230	50	1,1	7	35	2770	1300	60	F	55	37
ORB 4M	230	50	1,5	9,8	40	2820	1600	62	F	55	53
ORB 5M	230	50	2,2	13,5	50	2800	1900	64	F	55	70
ORB 6M	230	50	3	17,7	60	2850	2200	65	F	55	86
ORB 1T	380	50	0,37	1,05	-	2800	950	56	F	55	30
ORB 2T	380	50	0,75	1,75	-	2760	1000	59	F	55	35
ORB 3T	380	50	1,1	2,3	-	2770	1300	60	F	55	37
ORB 4T	380	50	1,5	3,3	-	2820	1600	62	F	55	53
ORB 5T	380	50	2,2	4,5	-	2800	1900	64	F	55	70
ORB 6T	380	50	3	5,8	-	2850	2200	65	F	55	86
ORB 7T	380	50	4	7,9	-	2880	2500	69	F	55	96
ORB 8T	380	50	5,5	10,3	-	2900	3000	72	F	55	108
ORB 9T	380	50	7,5	13,6	-	2910	4000	74	F	55	125

The sound level is measured at a distance of 3 m in open field condition.

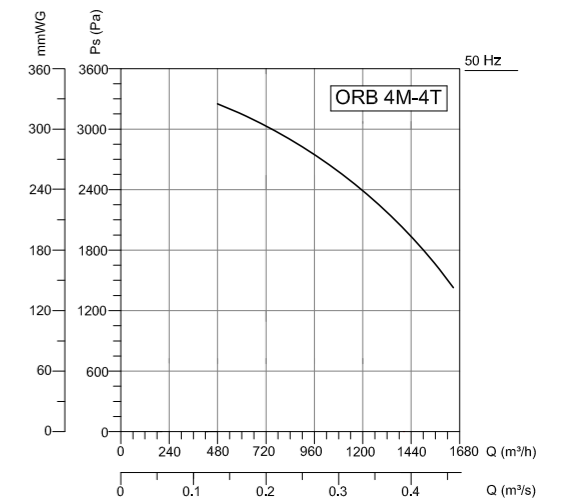
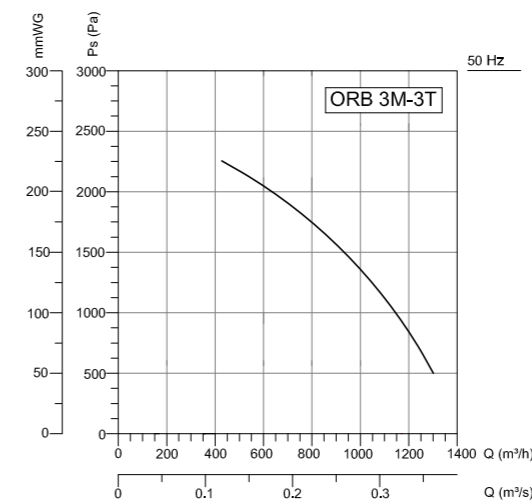
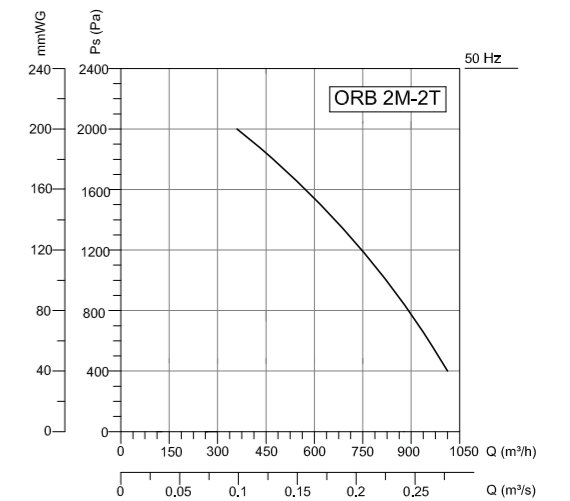
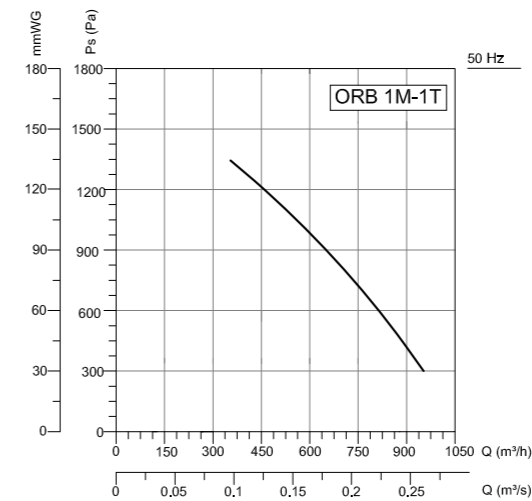



BDS

INDUSTRIAL RADIAL FANS / Forward Curved

Fan Components and Material Properties

The fan housing is made of pressurized aluminum casting. The fans operate at high efficiency and low noise level. In centrifugal fans, higher air transfer is possible due to the fact that the motor is out of airflow. Three-phase and single-phase asynchronous motor uses.

Fan Structure

Single suction, forward curved radial fan type. The fan wheel is made of high quality galvanized steel which is resistant to corrosion and is manufactured in aerodynamic structure to ensure regular flow. Thanks to its aerodynamic wing structure, it works quietly.

Benefits

It has a more rigid body structure. It works with low noise levels and is designed to be maintained

free for long periods of time. Due to its frequent wing structure and efficient motor, it produces high flow rate and pressure compared to its dimensions. Provides advantages in areas where space is limited. Fan flow rate can be controlled with KLEPE. It is not affected by hot and steam air currents. Speed can be adjusted with speed control devices.

Speed Control

Optional control devices can be provided. Speed control with frequency inverter can be done in 3-phase products (see BSC-F accessory)

Usage Areas

For cooling of machines, solid fuel boilers, industrial furnaces, resistance heating applications etc. Rigid body and high performance are used in the desired areas.

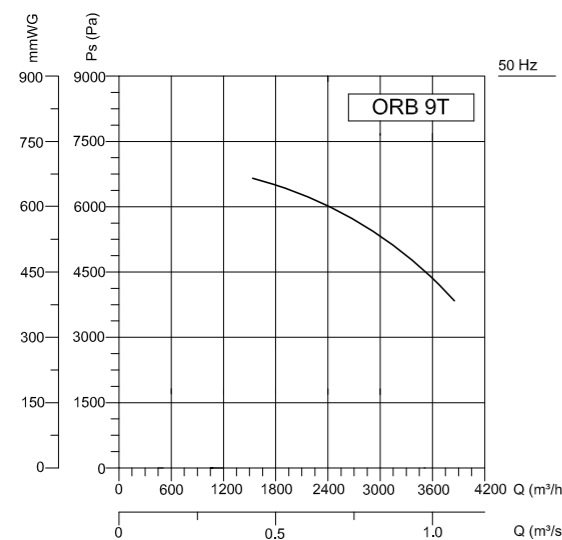
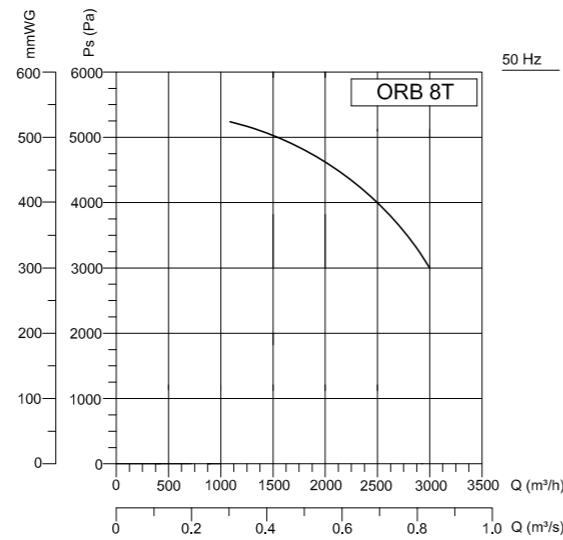
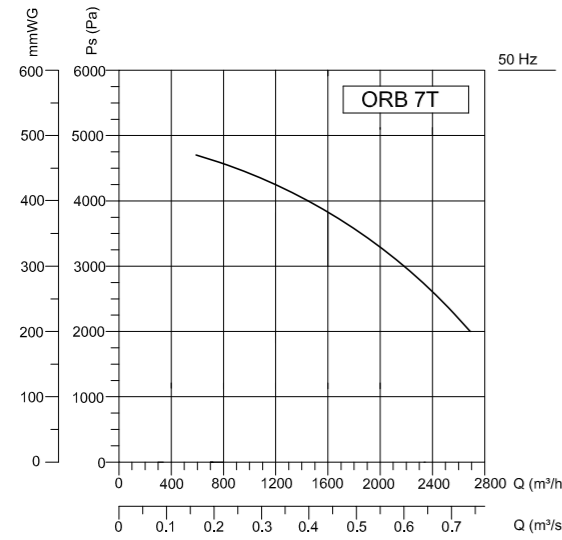
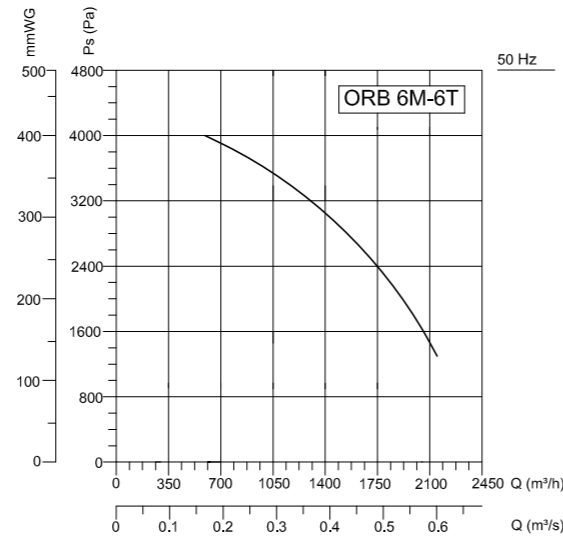
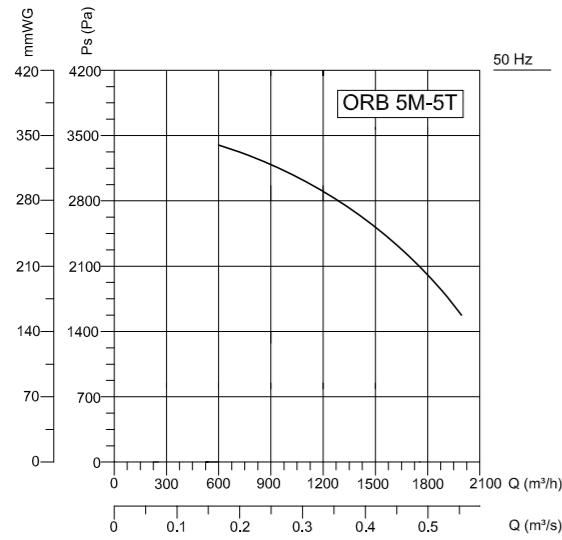

Technical Drawing and Tables

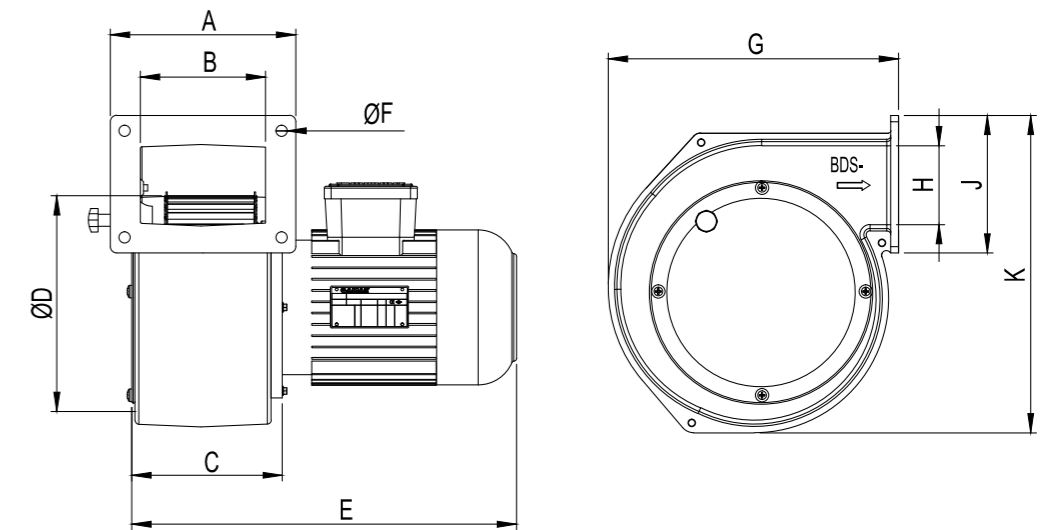

TYPE	A	B	C	D	E	F	G	H	J	K
BDS 1	133	88	127	140	310	7	230	65	125	240
BDS 2	155	114	148	160	360	9	285	108	163	280
BDS 3	160	117	157	180	360	9	310	108	163	300
BDS 4	187	127	168	225	390	9	370	100	163	380
BDS 5	200	155	185	250	435	9	400	155	205	435
BDS 6	200	155	195	268	465	9	405	155	205	440
BDS 7	240	170	200	300	555	10	480	170	250	510
BDS 8	240	170	200	315	555	10	490	170	250	510

Dimensions are in (mm)

Accessories



BSC-F BYF

TYPE	VOLTAGE	FREQUENCY	POWER	CURRENT	CAPACITOR	SPEED	AIR FLOW	SOUND PRESSURE	INSULATION CLASS	PROTECTION CLASS	WEIGHT
	V	Hz	kW	(A)	(μ F)	r.p.m	m ³ /h	dB(A)	Ins.cl.	IP	kg
BDS 1M (140-70)	230	50	0,25	1,6	10	2870	800	50	F	55	9
BDS 2M (160-90)	230	50	0,37	2,5	15	2885	1700	55	F	55	11
BDS 3M (180-90)	230	50	0,55	3,5	20	2865	2100	60	F	55	13
BDS 4M (225-90)	230	50	0,75	5	30	2770	2600	65	F	55	18
BDS 4M (225-102)	230	50	1,1	7	35	2770	3200	68	F	55	19
BDS 5M (250-112)	230	50	1,5	9,8	40	2820	3700	70	F	55	25
BDS 6M (268-112)	230	50	2,2	13,5	50	2800	4650	71	F	55	31
BDS 1T (140-70)	380	50	0,25	0,67	-	2840	800	50	F	55	9
BDS 2T (160-90)	380	50	0,37	1,05	-	2800	1700	55	F	55	11
BDS 3T (180-90)	380	50	0,55	1,27	-	2780	2100	60	F	55	13
BDS 4T (225-90)	380	50	0,75	1,75	-	2760	2600	65	F	55	18
BDS 4T (225-102)	380	50	1,1	2,3	-	2770	3200	68	F	55	19
BDS 5T (250-112)	380	50	1,5	3,3	-	2820	3700	70	F	55	25
BDS 6T (268-112)	380	50	2,2	4,5	-	2800	4650	71	F	55	31
BDS 7T (300-112)	380	50	4	7,9	-	2880	6200	72	F	55	43
BDS 8T (315-112)	380	50	5,5	10,3	-	2900	8400	73	F	55	48

The sound level is measured at a distance of 3 m in open field condition.

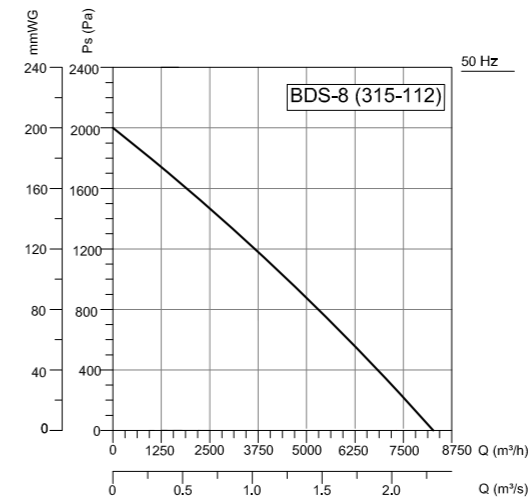
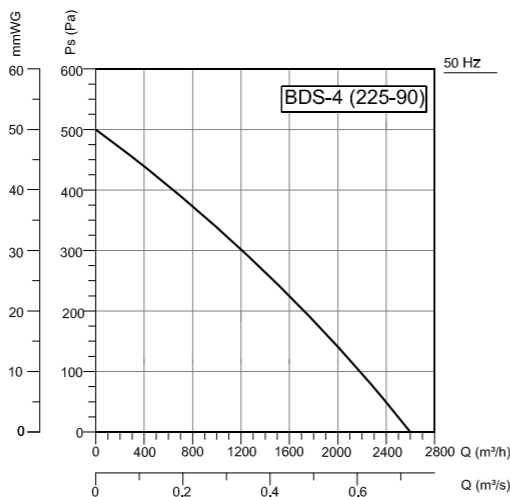
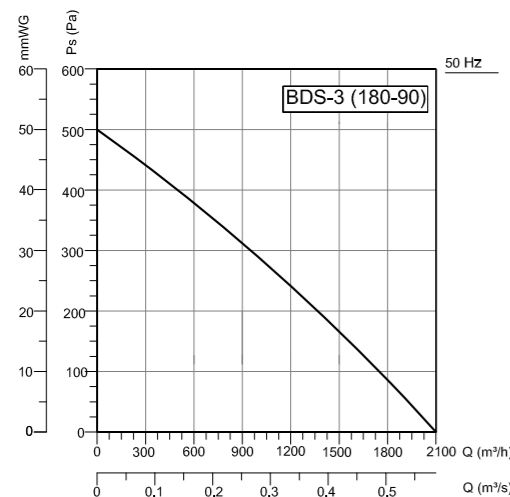
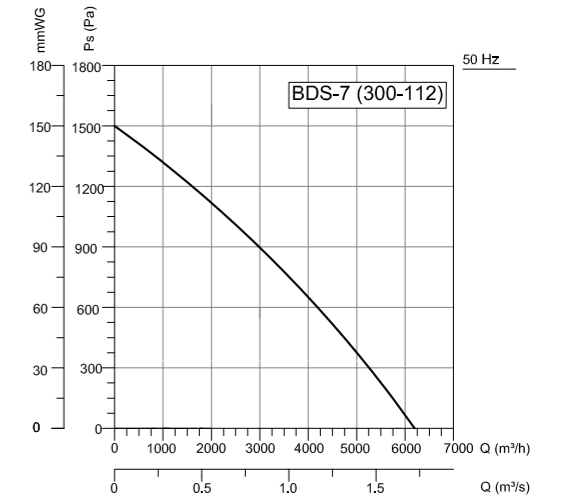
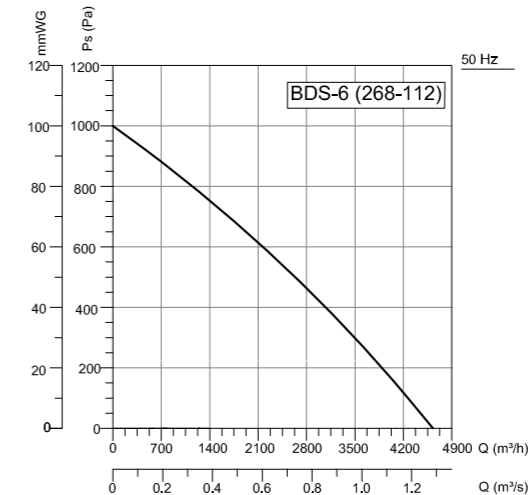
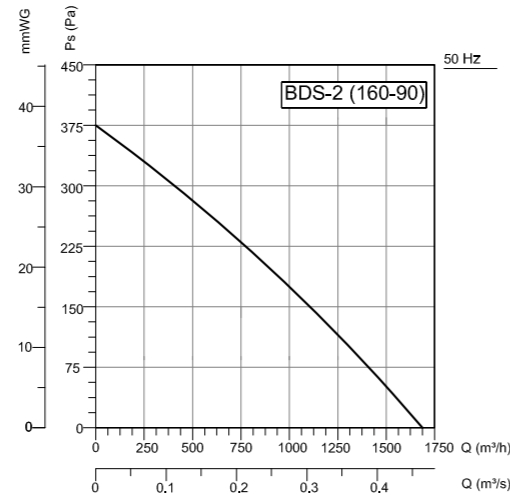
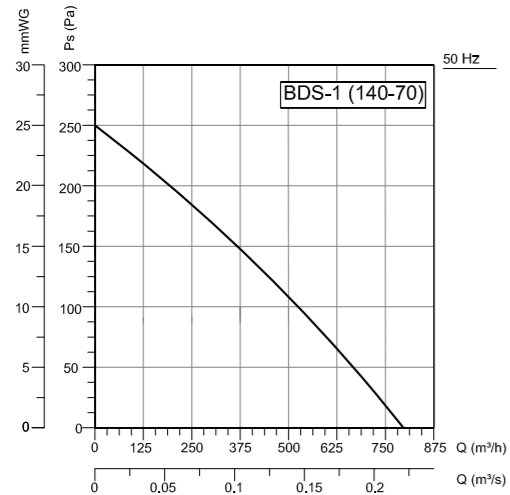
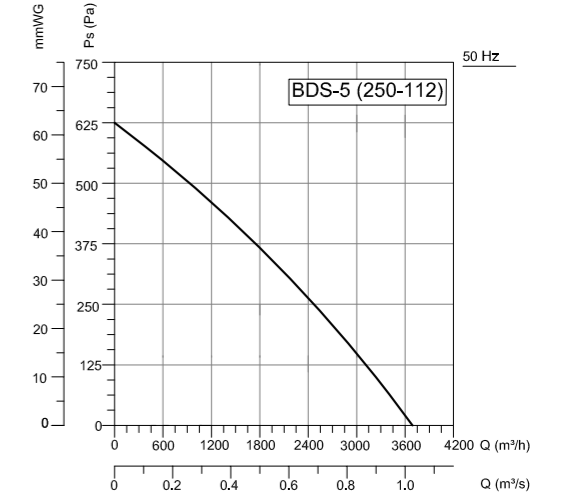
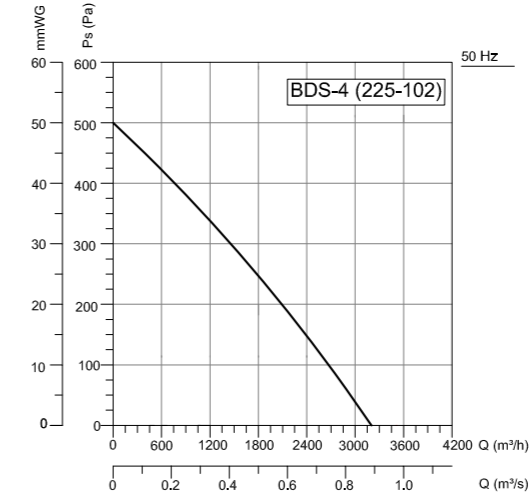



BDRAS

ALUMINIUM HOUSING / Forward Curved

Fan Components and Material Properties

BDRAS centrifugal fans have low noise level, high pressure properties. They save space thanks to their compact structure. The body is made of die-cast aluminum and is resistant to corrosion and corrosion. The motor and fan impeller are connected to the main body by steel carriers. The device is capable of handling air at max.40°C.

Fan Structure

The forward inclined fan wheel is made of high-quality galvanized steel that is resistant to corrosion and is manufactured in an aerodynamic manner to ensure regular flow. Thanks to its aerodynamic wing structure, it works quietly.

Benefits

It works with low noise levels and is designed to be maintenance-free for long periods of time. Because of both suction and shooting capability, it

is possible to dispose of the polluted air in the environment and fresh air to the environment. Can be installed in the desired pain. Speed can be adjusted with speed control devices. There is a protection grid in the fan suction and has a rigid body caused by the Aluminium die-cast body.

Speed Control

Optional control devices can be provided. * Speed control can be done with linear voltage regulator. (see BSC accessory)

Usage Areas

BDRAS series fans are mainly used in industrial and commercial areas; In general, it is used in local cooling applications and heating systems. It is preferred when the advantages of the aluminum rigid body such as cooling of machines, air supply in solid fuel boilers, yacht air conditioners and electrical panels can be used.

Technical Drawing and Tables

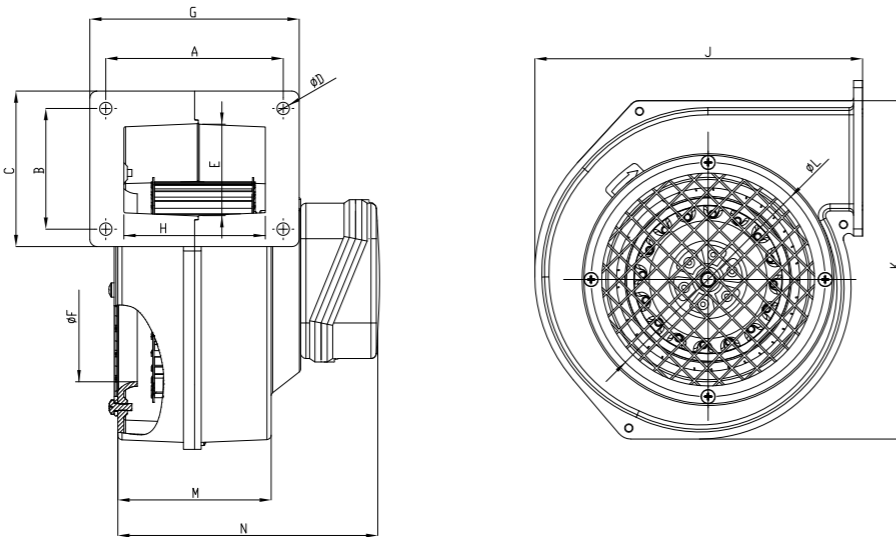

TYPE	A	B	C	D	E	F	G	H	J	K	L	M	N
BDRAS 85-40	66	58	70	5,5	42	63	76	56	117,5	127,5	84	80	120
BDRAS 108-50	96,5	65	85	7	50	87	115	76	159	183	118	82	122
BDRAS 120-60	99	67,5	88	7	49	103,5	118,5	80	190	184	122	87	145
BDRAS 140-60	123	84	122	7	78	110	154	79	197	203	147	100	151
BDRAS 160-60	114	105	123	7	90	117,5	130	93,5	229	248	164	100	135

Dimensions are in (mm)

TYPE	VOLTAGE	FREQUENCY	POWER	CURRENT	CAPACITOR	SPEED	AIR FLOW	SOUND PRESSURE	INSULATION CLASS	PROTECTION CLASS	WEIGHT
	V	Hz	W	(A)	(µF)	r.p.m	m ³ /h	dB(A)	Ins.cl.	IP	kg
BDRAS 85-40	230	50/60	30	0,13	1	2500	90	40	B	44	1,2
BDRAS 108-50	230	50/60	40	0,19	1,5	1900	155	42	B	44	1,7
BDRAS 120-60	230	50/60	85/105	0,38/0,46	2,5	2400	290	45	B	44	2,8
BDRAS 140-60	230	50/60	138/175	0,61/0,77	4	2300	485	47	B	44	3,4
BDRAS 160-60	230	50/60	200/255	0,88/1,12	6	2250	600	50	B	44	4,3

Sound Level Measured from 3m distance in room condition.

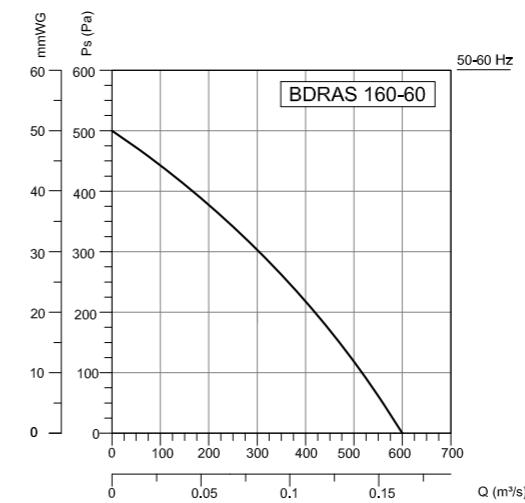
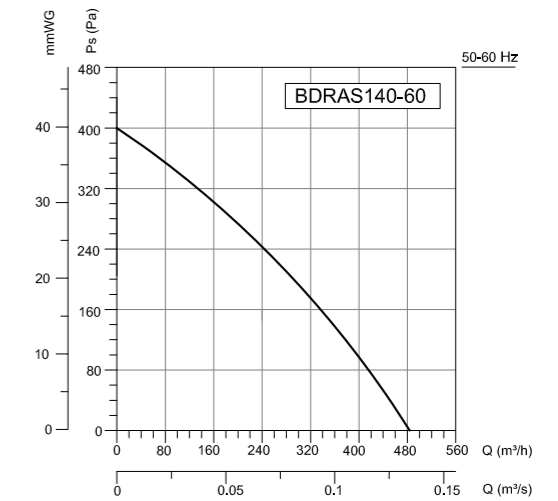
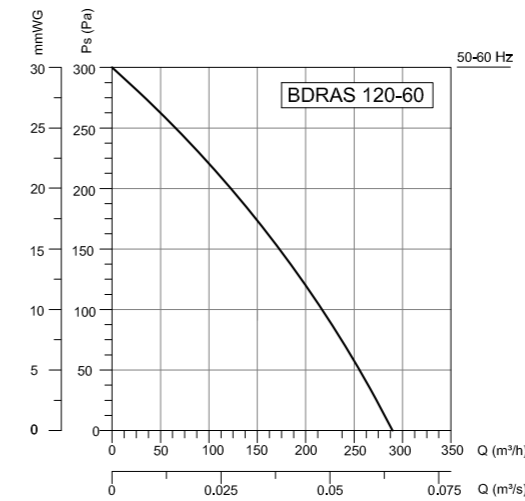
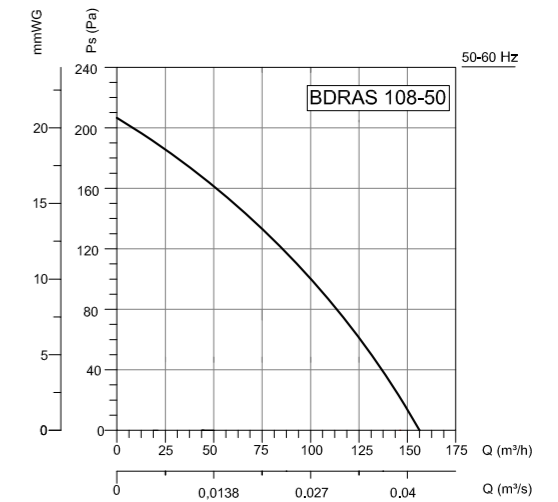
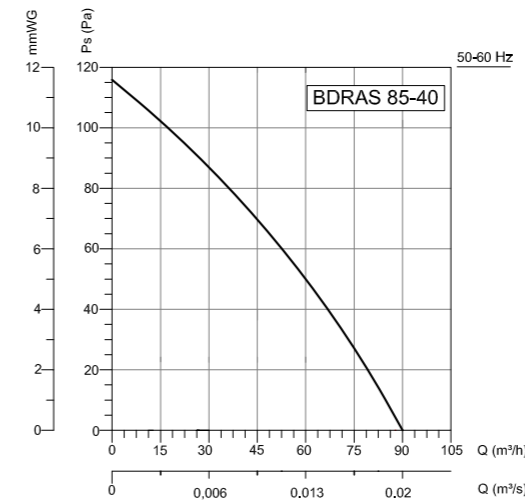

Accessories



BSC

BDRAS FLANGE TYPES

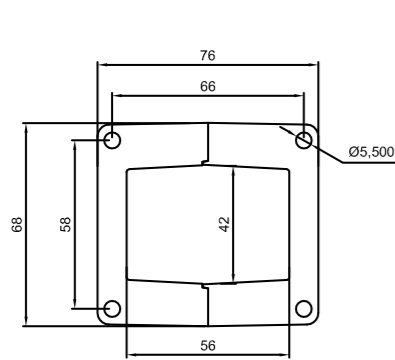

BDRAS 85-40

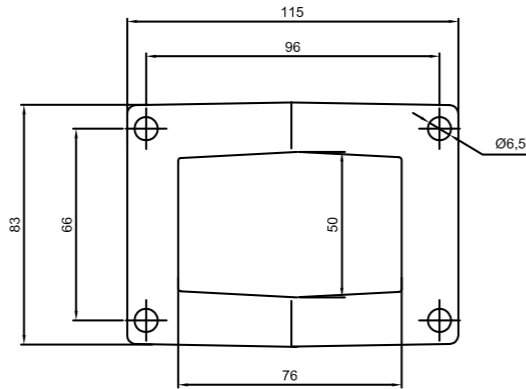

BDRAS 108-50

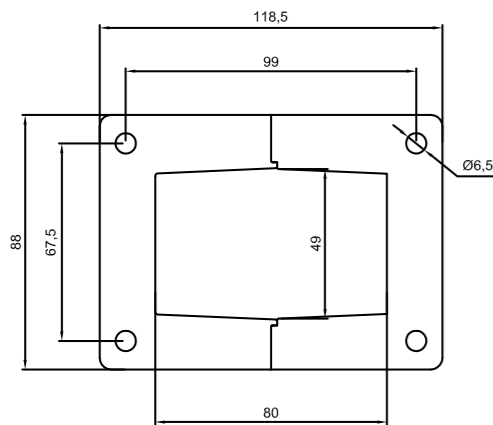

BDRAS 120-60

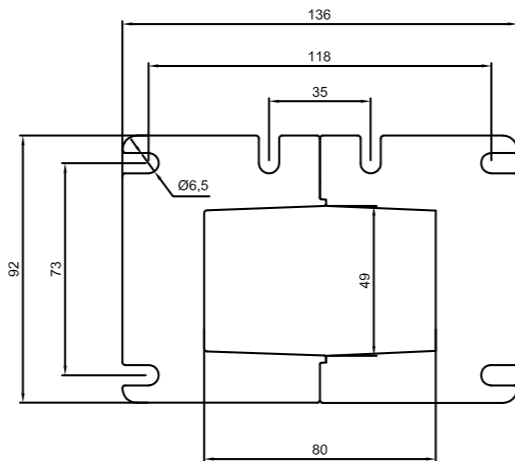

BDRAS 120-60

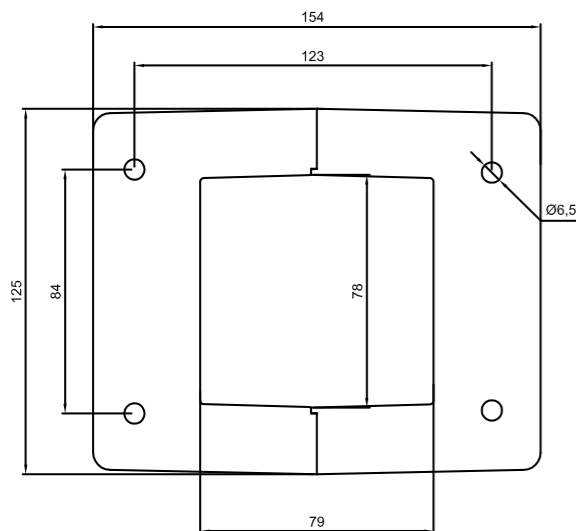

BDRAS 140-60

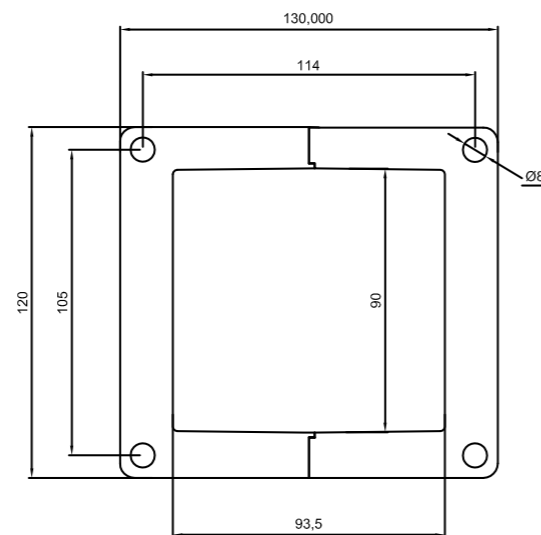

BDRAS 160-60



BDRS

SHEET METAL HOUSING / Forward Curved

Fan Components and Material Properties

Body and hat are made of electrostatic powder coated sheet metal. The protective wire cage is made of electrostatic powder coated steel. The motor and fan impeller are connected to the main body by steel carriers. The device is capable of handling air at max.40°C.

Fan Structure

The wings made of galvanized and manufactured in aerodynamic structure to provide airfoil and regular flow. Thanks to its aerodynamic wing structure, it works quietly.

Benefits

It works with low noise levels and is designed to be maintenance-free for long periods of time. Because of both suction and shooting capability, it is possible to dispose of the polluted air in the environment and fresh air to the environment. Can be installed in the desired pain. Speed can be adjusted with speed control devices.

Speed Control

Optional control devices can be provided. With 1-phase products, speed control can be done with linear voltage regulator. (see BSC accessory) 3-phase products can be controlled by frequency inverter (see BSC-F accessory).

Usage Areas

BDRS centrifugal fans have low noise level, high pressure properties. They save space thanks to their compact structure. It is lightweight and easy to assemble. It is resistant to corrosion by its electrostatic painted outer body. It is installed in solid fuel boilers and transmits the fresh air required for combustion to the combustion chamber.

Technical Drawing and Tables

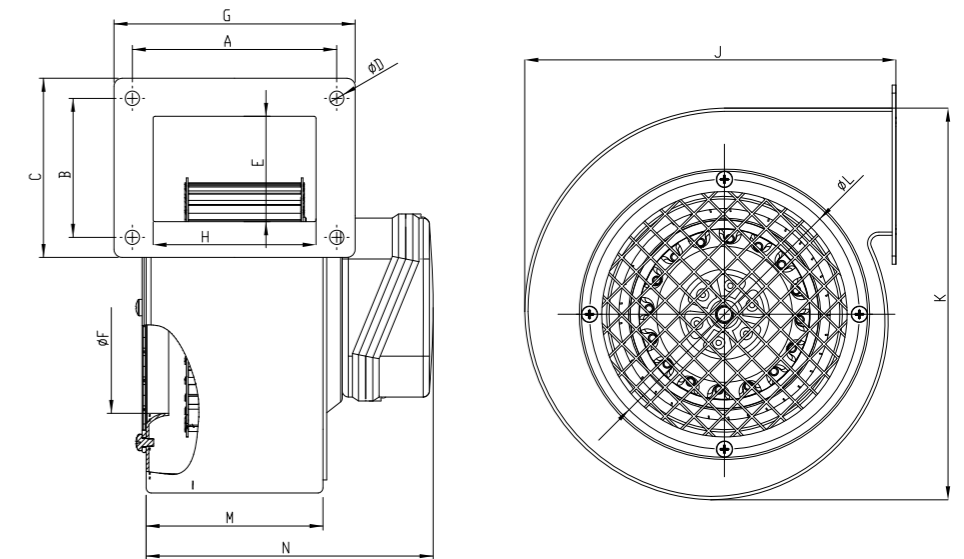

TYPE	A	B	C	D	E	F	G	H	J	K	L	M	N
BDRS 125-50	77	72	88	5	62	98	86	66	170	180	128	66	94
BDRS 120-60	98,5	68,5	100	5	68,5	97,5	115,5	81	173	183	133	83	134
BDRS 140-60	112	112	129,3	5	91,5	112	129	83,5	206	216	151	86	133
BDRS 160-60	112	112	129,3	5	92,5	130	129	84	270	260	165	86	133

Dimensions are in (mm)

TYPE	VOLTAGE	FREQUENCY	POWER	CURRENT	CAPACITOR	SPEED	AIR FLOW	SOUND PRESSURE	INSULATION CLASS	PROTECTION CLASS	WEIGHT
	V	Hz	W	(A)	(μ F)	r.p.m	m ³ /h	dB(A)	Ins.cl.	IP	kg
BDRS 125-50	230	50/60	80/100	0,35/0,44	2,5	2450/2600	250/265	42	B	44	2,3
BDRS 120-60	230	50/60	85/105	0,38/0,46	2,5	2250/2550	275/310	46	B	44	2,5
BDRS 140-60	230	50/60	138/175	0,61/0,77	4	2300	485	48	B	44	3,2
BDRS 160-60	230	50/60	200/255	0,88/1,12	6	2250	600	52	B	44	4,3

Sound Level Measured from 3m distance in room condition.

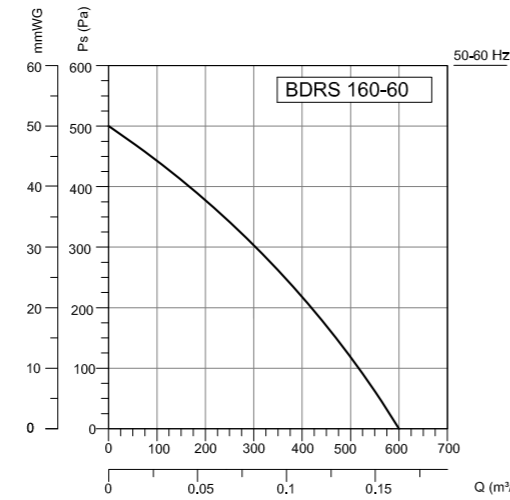
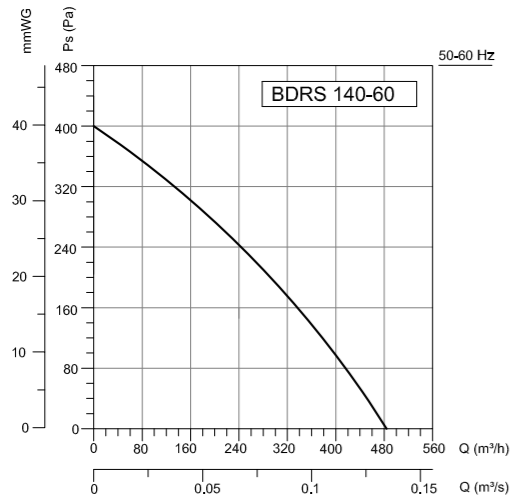
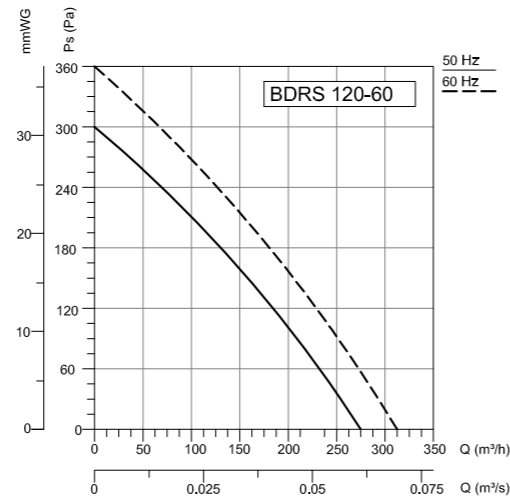
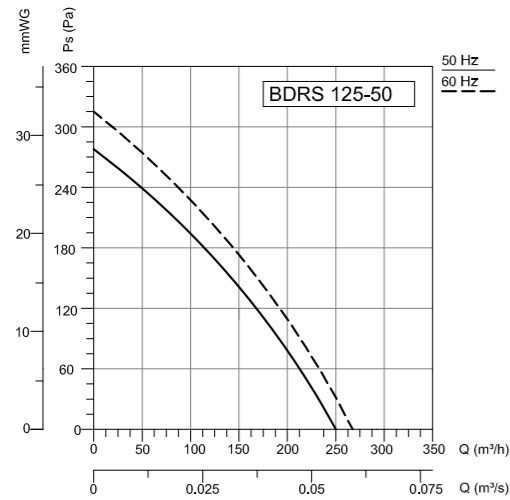

Accessories



BSC



AORB

SHEET METAL HOUSING / Forward Curved

Fan Components and Material Properties

AORB centrifugal fans have low noise, high pressure properties. Body is made of electrostatic powder coated sheet metal. They save space thanks to their compact structure. It is lightweight and easy to assemble. The motor and fan impeller are connected to the main body by steel carriers. Device max. It is capable of carrying air at a temperature of 40°C.

Fan Structure

The forward inclined fan wheel is made of high-quality galvanized steel that is resistant to corrosion and is manufactured in an aerodynamic manner to ensure regular flow. Thanks to its aerodynamic wing structure, it works quietly. protection grille in fan suction. The fan is made of high quality galvanized steel resistant to corrosion.

Benefits

It works with low noise levels and is designed to be maintenance-free for long periods of time.

Because of both suction and shooting capability, it is possible to dispose of the polluted air in the environment and fresh air to the environment. Can be mounted at the desired angle. Speed can be adjusted with speed control devices. Protection grill is available in fan suction.

Speed Control

Optional control devices can be provided. 1~phase products with linear voltage regulator-speed control can be done. (see BSC accessory) 3~phase products with frequency inverter speed-control can be done. (see BSC-F accessory)

Usage Areas

The AORB fan is compact in size, providing space saving for a wide range of ventilation and cooling applications. It produces higher flow rates than other fans in its segment. It is installed in solid fuel boilers and transmits the fresh air required for combustion to the combustion chamber.

Technical Drawing and Tables

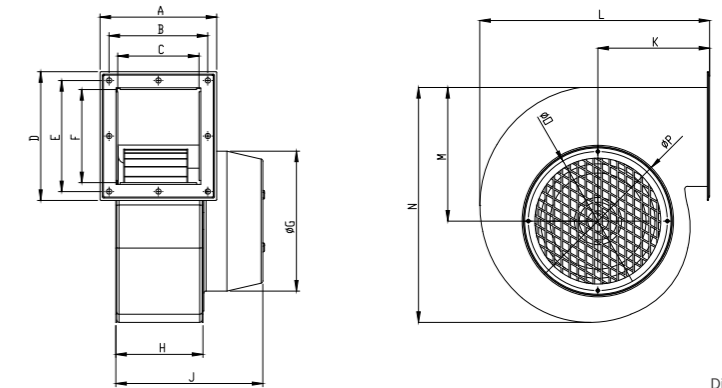

Dimensions are in (mm)

TYPE	A	B	C	D	E	F	G	H	J	K	L	M	N	O	P
AORB	150	125	105	163	139	120	174	109	185	142	290	170	298	143	186

TYPE	VOLTAGE	FREQUENCY	POWER	CURRENT	CAPACITOR	SPEED	AIR FLOW	SOUND PRESSURE	INSULATION CLASS	PROTECTION CLASS	WEIGHT
	V	Hz	W	(A)	(μ F)	r.p.m	m ³ /h	dB(A)	Ins.cl.	IP	kg
AORB-M	230	50	575	2,7	6	2450	1200	58	B	44	8,7
AORB-T	380	50/60	415/590	0,78/1	-	2750	1200	58	B	44	8,7

The sound level is measured at a distance of 3 m in open field condition.

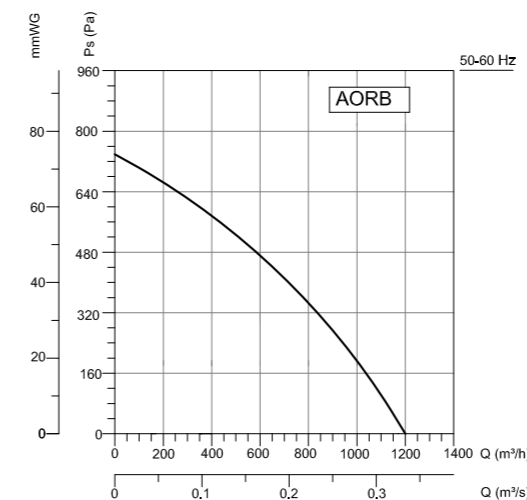

Accessories



BSC



BSC-F



BPS 140-60

PLASTIC HOUSING / Forward Curved

Fan Components and Material Properties

It has plastic injection body and corrosion resistant plastic fan. The external rotor motor is used to create a compact structure and the device is max. It is capable of carrying air at a temperature of 40°C.

Fan Structure

The forward inclined fan wheel is manufactured from corrosion-resistant plastic and aerodynamically designed to provide regular flow. Thanks to its aerodynamic wing structure, it works quietly, protection grille in fan suction. The fan is made of high quality galvanized steel resistant to corrosion.

Benefits

It works with low noise levels and is designed to be maintenance-free for long periods of time. It can be mounted at desired angle and it has circular section output. In the fan suction, there is a

protection grill in one piece with the body. BPS fans are preferred in applications where acidic or humid air is present. It is lightweight due to its plastic structure. The body has rectangular section output. Speed can be adjusted with speed control devices.

Speed Control

Optional control devices can be provided. * Speed control can be done with linear voltage regulator. (see BSC accessory)

Usage Areas

BPS fans are preferred in applications where acidic or humid air is present. Due to the plastic structure of the material is light, does not bring large loads where used. Not affected by corrosive air currents.

Technical Drawing and Tables

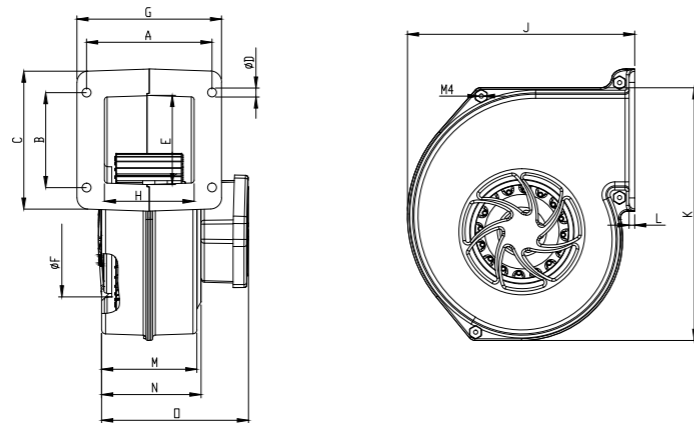

Dimensions are in (mm)

TYPE	A	B	C	D	E	F	G	H	J	K	L	M	N	O
BPS 140-60	110,5	83,5	123	6	76	110	128,5	79,5	201	225	5	85,5	90	130

TYPE	VOLTAGE	FREQUENCY	POWER	CURRENT	CAPACITOR	SPEED	AIR FLOW	SOUND PRESSURE	INSULATION CLASS	PROTECTION CLASS	WEIGHT
	V	Hz	W	(A)	(µF)	r.p.m	m³/h	dB(A)	Ins.cl.	IP	kg
BPS 140-60	230	50/60	150/200	0,66/0,87	4	2500	500	48	B	44	2,4

Sound Level Measured from 3m distance in room condition.

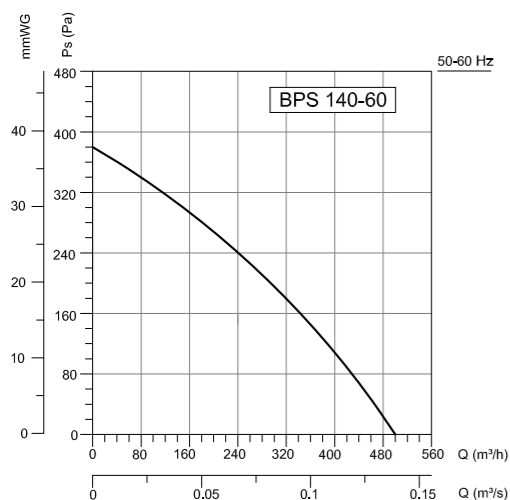

Accessories



BSC



BPS-B 140-60

PLASTIC HOUSING / Forward Curved

Fan Components and Material Properties

It has a plastic injection body and corrosion resistant galvanized steel fan. The external rotor motor is used to create a compact structure and the device is max. It is capable of carrying air at a temperature of 40°C.

Fan Structure

The forward sloped fan wheel is made of high quality galvanized steel which is resistant to corrosion and they are manufactured in aerodynamic structure to ensure regular flow. Thanks to its aerodynamic wing structure, it works quietly. The fan is made of high quality galvanized steel resistant to corrosion.

Benefits

It works with low noise levels and is designed to be maintenance-free for long periods of time. It can be mounted at desired angle and it has circular section output. Speed can be adjusted with speed control devices.

Speed Control

Optional control devices can be provided. * Speed control can be done with linear voltage regulator. (see BSC accessory)

Usage Areas

Due to the plastic structure of the material is light, does not bring large loads where used. Not affected by corrosive air currents.

Technical Drawing and Tables

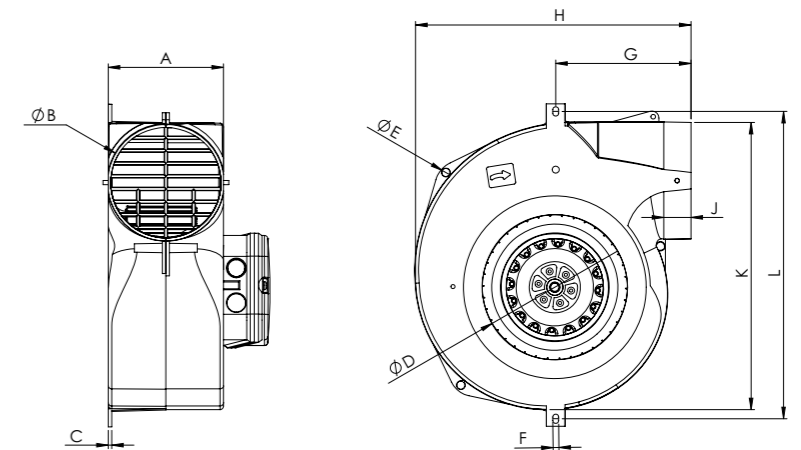

Dimensions are in (mm)

TYPE	A	B	C	D	E	F	G	H	J	K	L
BPS-B 140-60	96	100	3	126	7	5	113	239	22	246	264

TYPE	VOLTAGE	FREQUENCY	POWER	CURRENT	CAPACITOR	SPEED	AIR FLOW	SOUND PRESSURE	INSULATION CLASS	PROTECTION CLASS	WEIGHT
	V	Hz	W	(A)	(µF)	r.p.m	m³/h	dB(A)	Ins.cl.	IP	kg
BPS-B 140-60	230	50/60	110/140	049/0,63	4	2570/2900	500/565	48	B	44	2,8

Sound Level Measured from 3m distance in room condition.

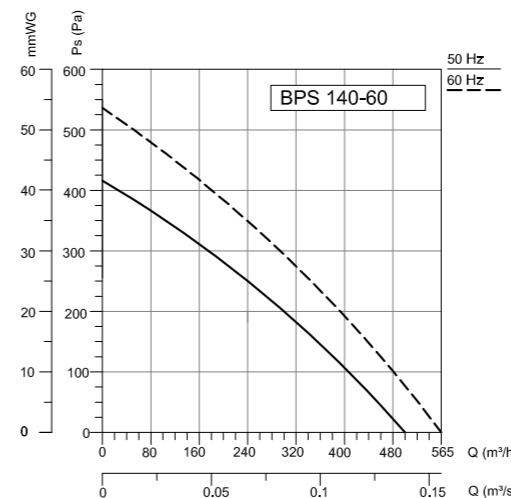

Accessories



BSC



BPS-B 150-100

PLASTIC HOUSING / Double Inlet

Fan Components and Material Properties

It has a plastic injection body and corrosion resistant galvanized steel fan. The external rotor motor is used to create a compact structure and the device is max. It is capable of carrying air at a temperature of 40°C.

Fan Structure

The forward sloped fan wheel is made of high quality galvanized steel which is resistant to corrosion and they are manufactured in aerodynamic structure to ensure regular flow. Thanks to its aerodynamic wing structure, it works quietly. The fan is made of high quality galvanized steel resistant to corrosion.

Benefits

It works with low noise levels and is designed to be maintenance-free for long periods of time. It can be mounted at desired angle and it has circular section output. Speed can be adjusted with speed control devices.

Speed Control

Optional control devices can be provided. * Speed control can be done with linear voltage regulator. (see BSC accessory)

Usage Areas

Due to the plastic structure of the material is light, does not bring large loads where used. Not affected by corrosive air currents.

Technical Drawing and Tables

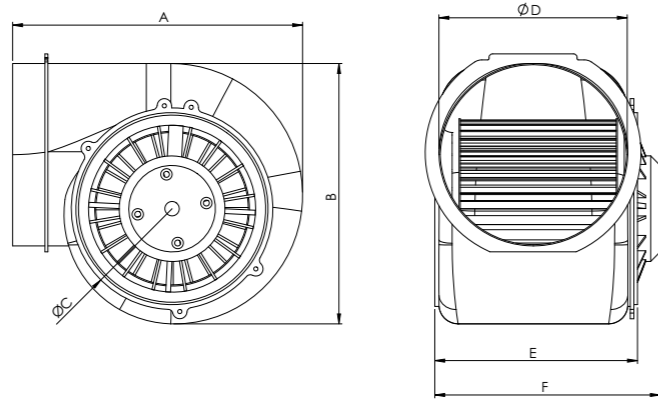

TYPE	A	B	C	D	E	F
BPS-B 150-100	241	217	156	150	165	185

Dimensions are in (mm)

TYPE	VOLTAGE	FREQUENCY	POWER	CURRENT	CAPACITOR	SPEED	AIR FLOW	SOUND PRESSURE	INSULATION CLASS	PROTECTION CLASS	WEIGHT
	V	Hz	W	(A)	(µF)	r.p.m	m³/h	dB(A)	Ins.cl.	IP	kg
BPS-B 150-100	230	50	180	0,9	6	1450	720	55	B	44	3,2

Sound Level Measured from 3m distance in room condition.

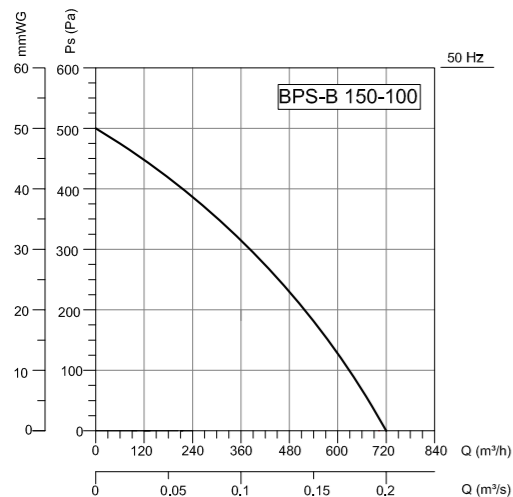

Accessories



BSC



OBR 140

SHEET METAL HOUSING / Forward Curved

Fan Components and Material Properties

Fan body is made of DKP sheet metal with electrostatic powder coating. The fans operate at high efficiency and low noise level. In centrifugal fans, higher air transfer is possible due to the fact that the motor is out of airflow. Uses asynchronous motor.

Fan Structure

Single suction, forward curved radial fan type. The fan wheel is made of high quality galvanized steel which is resistant to corrosion and is manufactured in aerodynamic structure to ensure regular flow. Thanks to its aerodynamic wing structure, it works quietly.

Benefits

It works with low noise levels and is designed to

be maintenance-free for long periods of time. Due to its frequent wing structure and efficient motor, it produces high flow rate and pressure compared to its dimensions. Provides advantages in areas where space is limited. Speed adjustable with speed control devices.

Speed Control

Optional control devices can be provided. 1-Phase products can be controlled with linear voltage regulator. (see BSC accessory)

Usage Areas

Greenhouses, factories, warehouses, paint shops, shopping centers, factories, plastic and packaging machines etc. The machine is also used by machine manufacturers, except for the use of the space ventilation.

Accessories

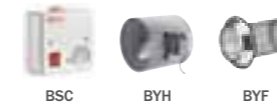

BSC

BYH

BYF

Technical Drawing and Tables

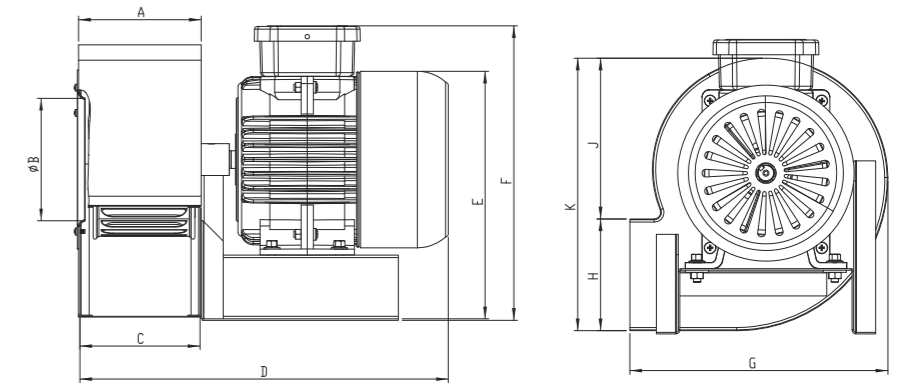

TYPE	A	B	C	D	E	F	G	H	J	K
OBR 140M	103	106	102	294	200	240	204	91	125	216

Dimensions are in (mm)

TYPE	VOLTAGE	FREQUENCY	POWER	CURRENT	CAPACITOR	SPEED	AIR FLOW	SOUND PRESSURE	INSULATION CLASS	PROTECTION CLASS	WEIGHT
	V	Hz	W	(A)	(µF)	r.p.m	m³/h	dB(A)	Ins.cl.	IP	kg
OBR 140M-2K	230	50/60	200/285	1,1/1,25	8	2930/3460	1100/1300	53	B	44	7,7
OBR 140M-4K	230	50/60	175	1,05/0,83	8	1480/1720	550/640	45	B	44	7,7

Sound Level Measured from 3m distance in room condition.

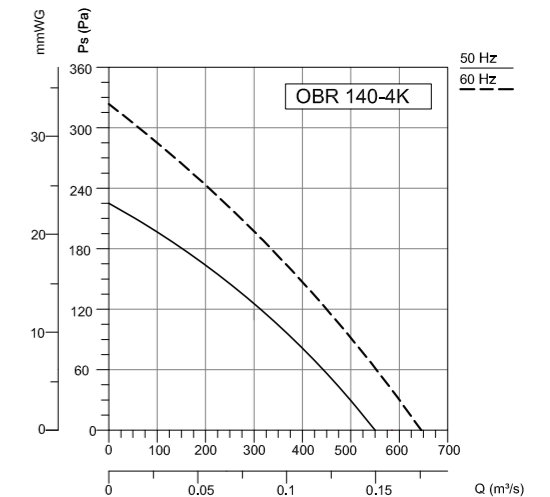
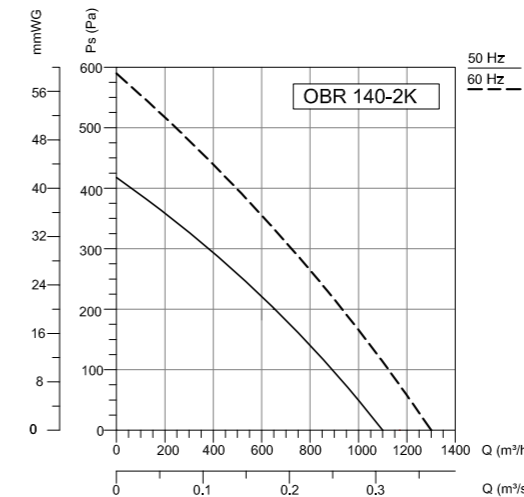



OBR 200

SHEET METAL HOUSING / Forward Curved

Fan Components and Material Properties

Fan body is made of DKP sheet metal with electrostatic powder coating. The fans operate at high efficiency and low noise level. In centrifugal fans, higher air transfer is possible due to the fact that the motor is out of airflow. Uses asynchronous motor.

Fan Structure

Single suction, forward curved radial fan type. The fan wheel is made of high quality galvanized steel which is resistant to corrosion and is manufactured in aerodynamic structure to ensure regular flow. Thanks to its aerodynamic blade structure, it works silently (200M-2K * model has aluminum cast sparse wings).

Benefits

It works with low noise levels and is designed to be maintenance-free for long periods of time. Due

to its frequent wing structure and efficient motor, it produces high flow rate and pressure compared to its dimensions. Provides advantages in areas where space is limited. Speed adjustable with speed control devices.

Speed Control

Optional control devices can be provided. 1-phase products with linear voltage regulator speed control can be done. (see BSC accessory) 3-phase products with frequency inverter speed control can be done. (see BSC-F accessory)

Usage Areas

Greenhouses, factories, warehouses, paint shops, shopping centers, factories, plastic and packaging machines etc. The machine is also used by machine manufacturers, except for the use of the space ventilation.

Accessories



Technical Drawing and Tables

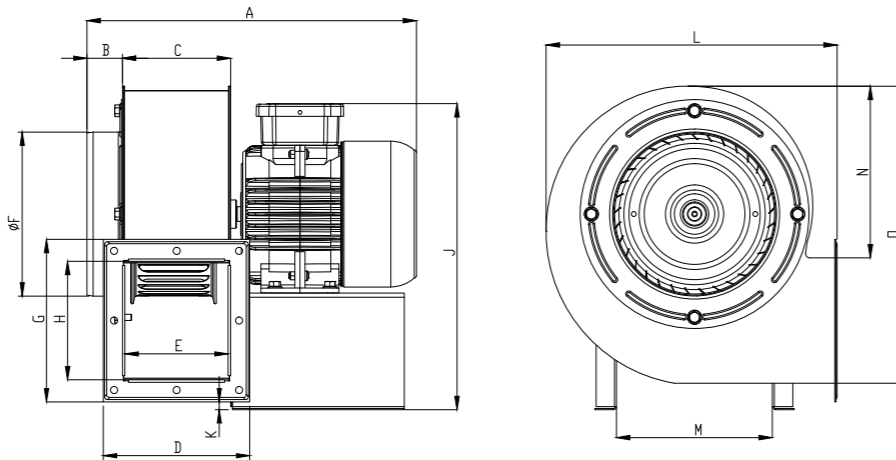

TYPE	A	B	C	D	E	F	G	H	J	K	L	M	N	O
OBR 200	322	34	109	146	102	163	161	115	310	17	288	150	170	295

Dimensions are in (mm)

TYPE	VOLTAGE	FREQUENCY	POWER	CURRENT	CAPACITOR	SPEED	AIR FLOW	SOUND PRESSURE	INSULATION CLASS	PROTECTION CLASS	WEIGHT
TYPE	V	Hz	W	(A)	(µF)	r.p.m	m ³ /h	dB(A)	Ins.cl.	IP	kg
OBR 200M-2K	230	50	450	2	8	2770	1800	55	B	44	9
OBR 200M-4K	230	50	190	1,1	8	1450	850	50	B	44	8,4
OBR 200M-2K*	230	50	260	1,5	8	2900	1700	55	B	44	9,3
OBR 200T-2K	380	50	140	0,7	-	2950	1800	60	B	44	8,3
OBR 200T-4K	380	50	190	0,9	-	1465	850	55	B	44	8,4

*Backward Curved Fans / The sound level is measured at a distance of 3 m in open field condition.

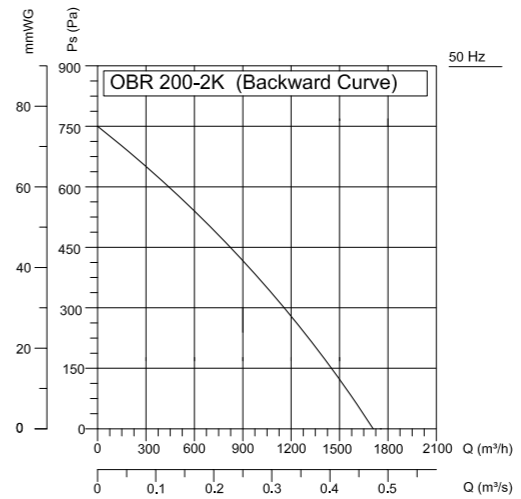
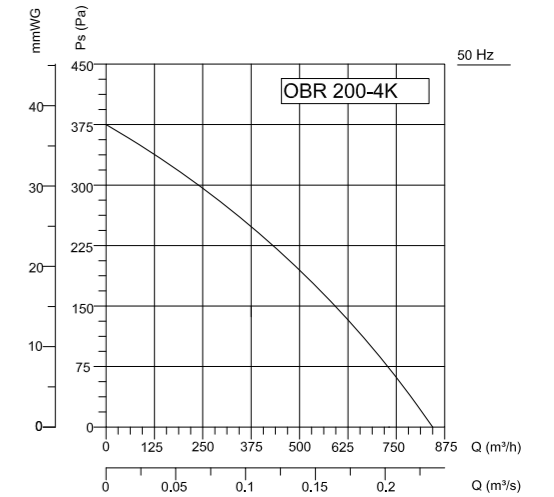
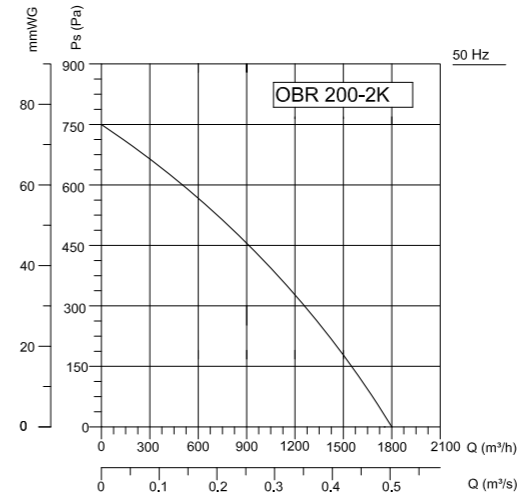



OBR 260

SHEET METAL HOUSING / Forward Curved

Fan Components and Material Properties

Fan body is made of DKP sheet metal with electrostatic powder coating. The fans operate at high efficiency and low noise level. In centrifugal fans, higher air transfer is possible due to the fact that the motor is out of airflow. Uses asynchronous motor.

Fan Structure

Single suction, forward curved radial fan type. The fan wheel is made of high quality galvanized steel which is resistant to corrosion and is manufactured in aerodynamic structure to ensure regular flow. Thanks to its aerodynamic wing structure, it works quietly.

Benefits

It works with low noise levels and is designed to be maintenance-free for long periods of time.

Due to its frequent wing structure and efficient motor, it produces high flow rate and pressure compared to its dimensions. Provides advantages in areas where space is limited. Speed adjustable with speed control devices.

Speed Control

Optional control devices can be provided. Speed control with frequency inverter can be done in 3-phase products (see BSC-F accessory)

Usage Areas

Greenhouses, factories, warehouses, paint shops, shopping centers, factories, plastic and packaging machines, olive screening machines, hot and dusty air circulation etc. The machine is also used by machine manufacturers, except for the use of the space ventilation.

Accessories



Technical Drawing and Tables

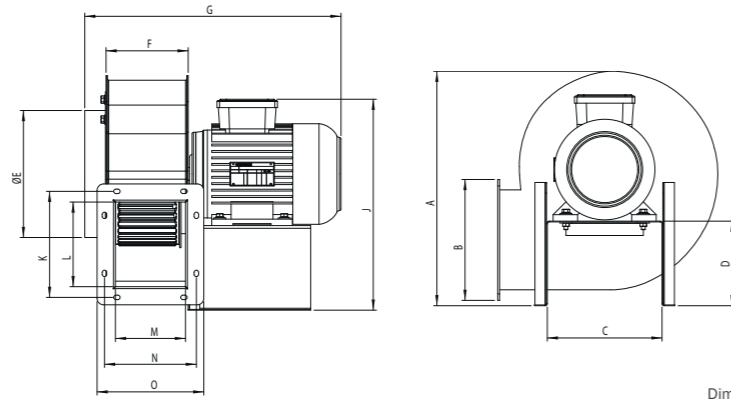

Dimensions are in (mm)

TYPE	A	B	C	D	E	F	G	J	K	L	M	N	O
OBR 260	361	194	155	119	197	128	405	327	162	137	115	140	163

TYPE	VOLTAGE	FREQUENCY	POWER	CURRENT	CAPACITOR	SPEED	AIR FLOW	SOUND PRESSURE	INSULATION CLASS	PROTECTION CLASS	WEIGHT
	V	Hz	kW	(A)	(µF)	r.p.m	m ³ /h	dB(A)	Ins.cl.	IP	kg
OBR 260M-2K	230	50	1,5	9,8	40	2820	2700	72	F	55	9,5
OBR 260M-4K	230	50	0,25	2,1	10	1380	1450	66	F	55	12,8
OBR 260T-2K	380	50	1,5	3,3	-	2820	2700	72	F	55	11,2
OBR 260T-4K	380	50	0,25	0,81	-	1380	1450	66	F	55	9,8

The sound level is measured at a distance of 3 m in open field condition.

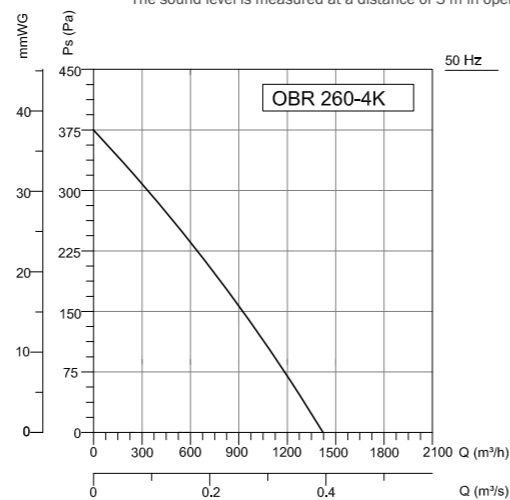
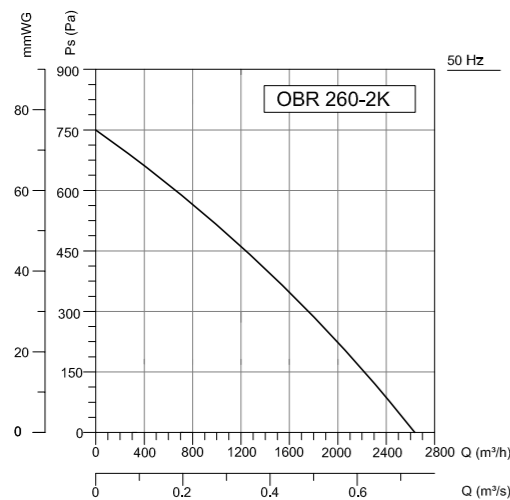

KMS/KTS

SHEET METAL HOUSING / Forward Curved

Fan Components and Material Properties

Fan body is made of DKP sheet metal with electrostatic powder coating. The fans operate at high efficiency and low noise level. In centrifugal fans, higher air transfer is possible due to the fact that the motor is out of airflow. Three-phase and single-phase asynchronous motor uses.

Fan Structure

Single suction, forward curved radial fan type. The fan wheel is made of high quality galvanized steel which is resistant to corrosion and is manufactured in aerodynamic structure to ensure regular flow. Thanks to its aerodynamic wing structure, it works quietly.

Benefits

It works with low noise levels and is designed to be maintenance-free for long periods of time.

Due to its frequent wing structure and efficient motor, it produces high flow rate and pressure compared to its dimensions. Provides advantages in areas where space is limited. It is not affected by hot and steam air currents. Speed can be adjusted with speed control devices.

Speed Control

Optional control devices can be provided. 1-phase products with linear voltage regulator speed control can be done. (see BSC accessory) 3-phase products with frequency inverter speed control can be done. (see BSC-F accessory)

Usage Areas

Machines, steam iron machines, packaging machines and so on. used in places. Apart from the use of space ventilation, it is used by machinery manufacturers for vacuum in machines and equipments.

Accessories



Technical Drawing and Tables

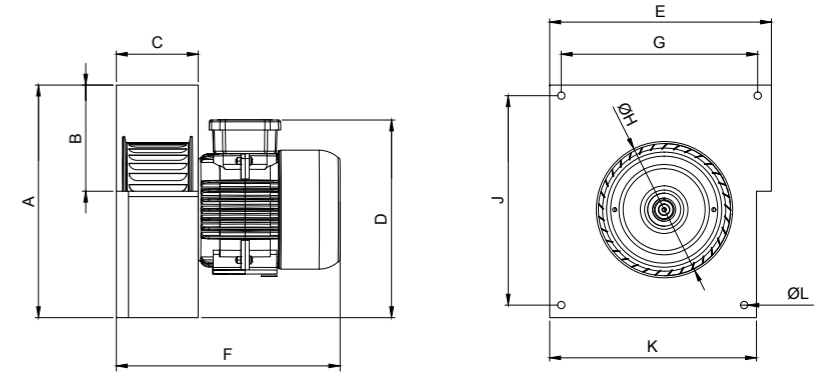

Dimensions are in (mm)

TYPE	A	B	C	D	E	F	G	H	J	K	L
KMS/KTS	278	114	106	231	248	282	198	178	235	238	8

TYPE	VOLTAGE	FREQUENCY	POWER	CURRENT	CAPACITOR	SPEED	AIR FLOW	SOUND PRESSURE	INSULATION CLASS	PROTECTION CLASS	WEIGHT
	V	Hz	W	(A)	(µF)	r.p.m	m ³ /h	dB(A)	Ins.cl.	IP	kg
KMS	230	50/60	390/590	1,9/2,6	8	2850/3150	1500/1650	60	B	44	7,5
KTS	380	50	460	1,1	-	2850	1500	60	B	44	7,5

The sound level is measured at a distance of 3 m in open field condition.

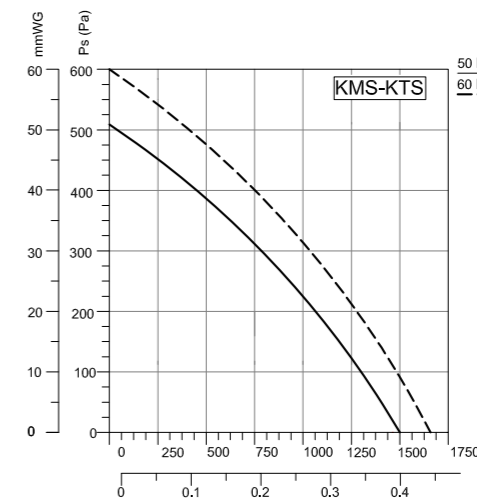



BFC

FANCOIL / Forward Curved

Fan Components and Material Properties

BFC double suction crossflow fans operate at high efficiency and low noise level. Manufactured from high quality galvanized steel resistant to corrosion. The motor and fan impeller are connected to the main body by aluminum carriers. The external rotor motor is used to create a compact structure and the device is max. It is capable of carrying air at a temperature of 40°C.

Fan Structure

The forward sloped fan wheel is made of high quality galvanized steel which is resistant to corrosion and they are manufactured in aerodynamic structure to ensure regular flow. Thanks to its aerodynamic wing structure, it works quietly.

Benefits

It works with low noise levels and is designed to be maintenance-free for long periods of time. It offers space saving according to its capacity. Due to its frequent wing structure and efficient motor, it produces high flow rate and pressure compared to its dimensions. Provides advantages in areas where space is limited. Speed can be adjusted with speed control devices.

Speed Control

Optional control devices can be provided. * Speed control can be done with linear voltage regulator. (see BSC accessory)

Usage Areas

Fancoil devices, local cooling applications, low noise where desired and air conditioning devices are used for air circulation.

Accessories



Technical Drawing and Tables

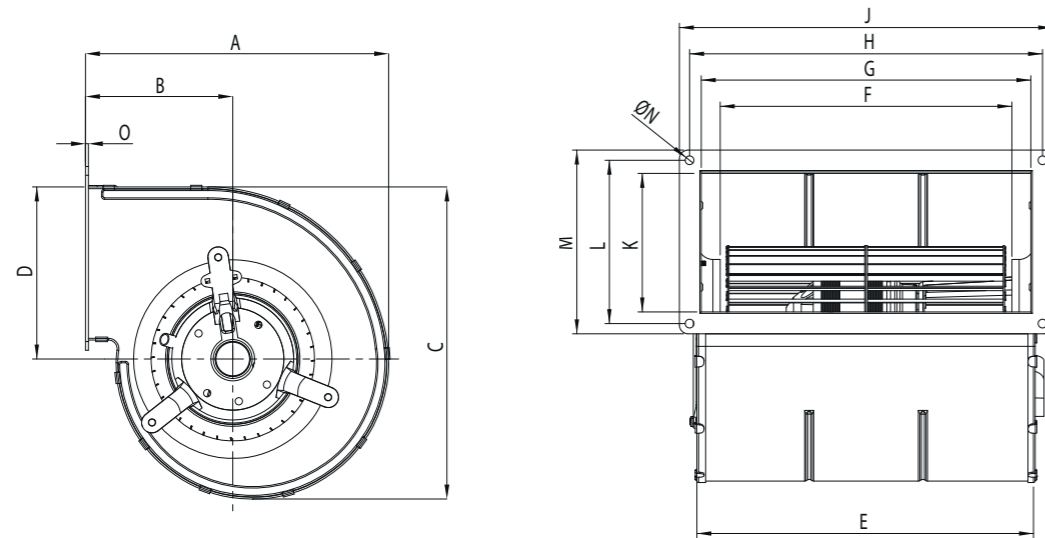

TYPE	A	B	C	D	E	F	G	H	J	K	L	M	N	O
BFC 133-146	208	101	214	118	231	200	226	242	256	95	112	126	06	2

Dimensions are in (mm)

TYPE	VOLTAGE	FREQUENCY	POWER	CURRENT	CAPACITOR	SPEED	AIR FLOW	SOUND PRESSURE	INSULATION CLASS	PROTECTION CLASS	WEIGHT
	V	Hz	W	(A)	(µF)	r.p.m	m³/h	dB(A)	Ins.cl.	IP	kg
BFC 133-2K	230	50/60	200/210	0,95/1	4	1300/1150	810/715	56	B	44	4,7
BFC 133-4K	230	50/60	95/110	0,42/0,49	3	1200/1150	750/720	55	B	44	4,7
BFC 146-2K	230	50/60	300/355	1,3/1,45	7	2000	1100	63	B	44	5
BFC 146-4K	230	50/60	95/115	0,42/0,50	3	1000/1130	775/875	62	B	44	5

Sound Level Measured from 3m distance in room condition.

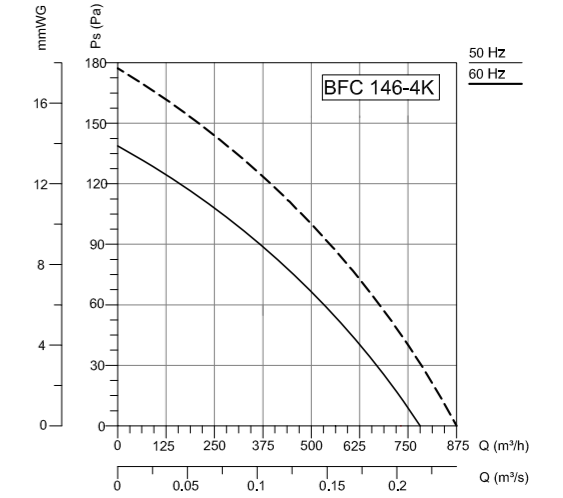
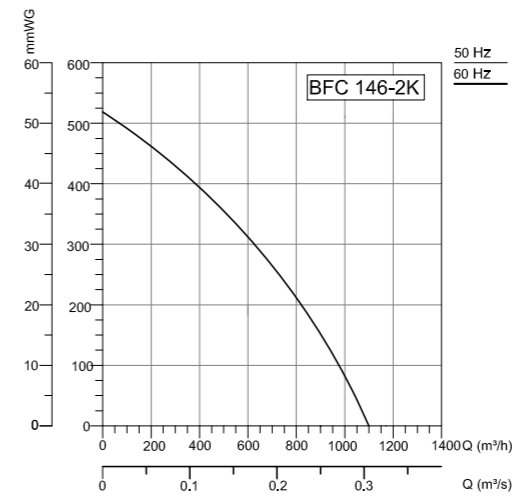
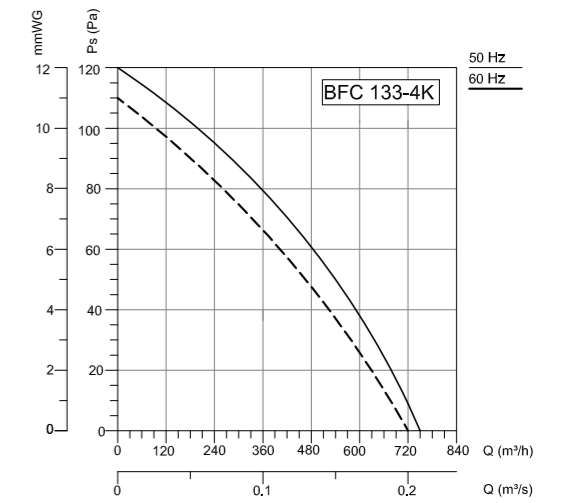
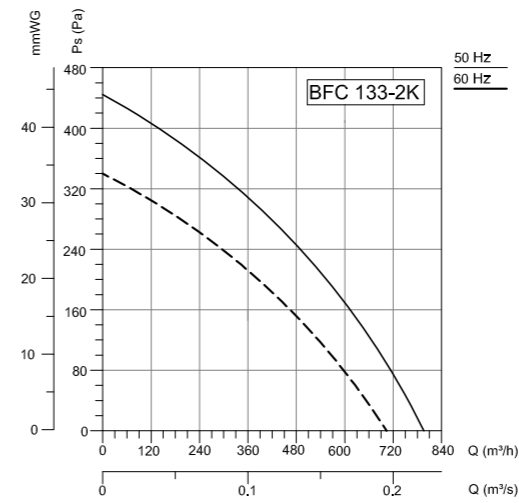



BRV

DOUBLE INLET RADIAL FANS / Forward Curved

Fan Components and Material Properties

Fan Body and fan are made of high quality galvanized steel which is resistant to corrosion. BRV double suction centrifugal fans are manufactured as standard in different sizes between 700 m³ / h and 25.000 m³ / h. The motor and fan impeller are produced on the shaft by means of double bearing and main body with steel carriers. Mat-ress protectors are made of rubber.

Fan Structure

Double suction, forward-curved low pressure radial type fan. The fan wheel is made of high quality galvanized steel which is resistant to corrosion and is manufactured in aerodynamic structure to ensure regular flow. Thanks to its aerodynamic wing structure, it works quietly.

Benefits

It produces high flow rate with its frequent wing structure. Speed adjustable with belt pulley drive system. The BRV-K models are reinforced.

Speed Control

Belt pulley system is made by changing the conversion rate.

Usage Areas

Box Fans and air handling units etc. they are preferred.

Technical Drawing and Tables

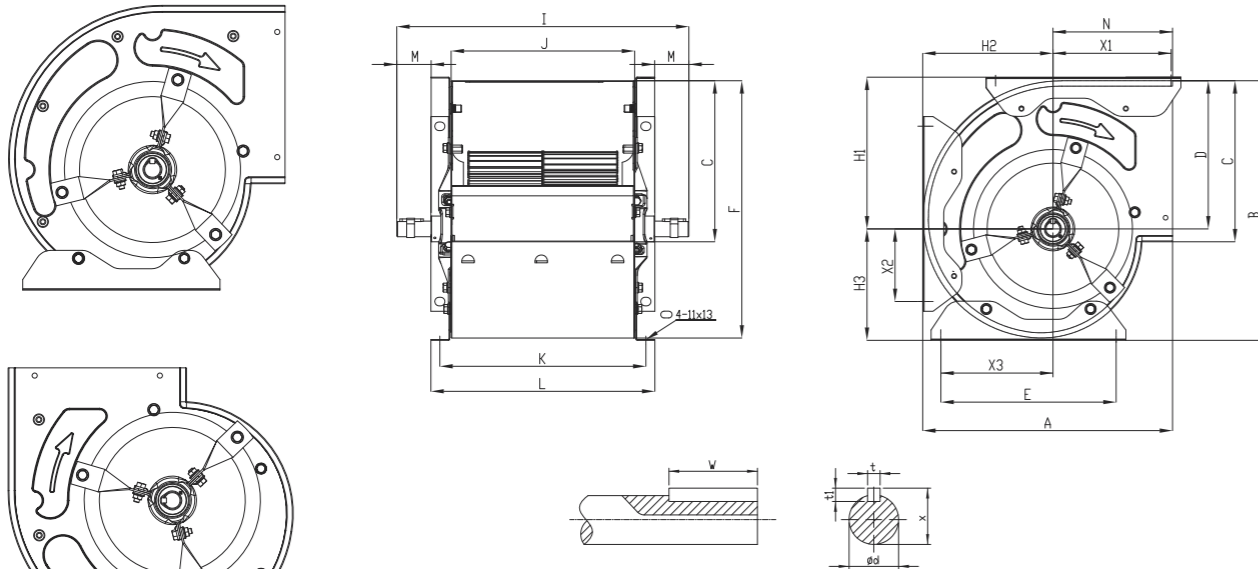

TYPE	AIR FLOW		WEIGHT
	m ³ /h		
BRV 7/7	3500		6.1
BRV 9/9	5000		8.2
BRV 10/10	6500		9.4
BRV 12/12	10000		15.5
BRV 15/15	16000		20.7
BRV 18/18	22000		40.5
BRV-K 15/15	18000		20.7
BRV-K 18/18	25000		40.5

Sound Level Measured from 3m distance in room condition.

TYPE	A	B	C	D	E	F	I	J	K	L	M	N	X	t	t1	W	d	H1	H2	H3	X1	X2	X3
BRV 7/7	321	333	207	190	225	330	375	236	264.5	287.5	44	154	22.5	6	6	30	20	195	167	142	152	93	144
BRV 9/9	390	400	261	218	300	390	435	296	325.5	350.5	44	217	22.5	6	6	30	20	225	208	182	202	114	184
BRV 10/10	435	455	290	250	339	445	500	333	361	386	57	197	28	8	7	50	25	258	238	205	161	146	200
BRV 12/12	498.5	535	336	292	409	520	580	398	428	453	65	229	28	8	7	50	25	304	270	243	223	139	257
BRV 15/15	597	620	402	341	497	610	650	476	505	531	60	264	28	8	7	60	25	349	324	279	260	214	301
BRV 18/18	687	753	477	411	605.5	732	754	559	591	614	71	313	28	8	7	65	25	424.5	375	342	282	281	330

Dimensions are in (mm)

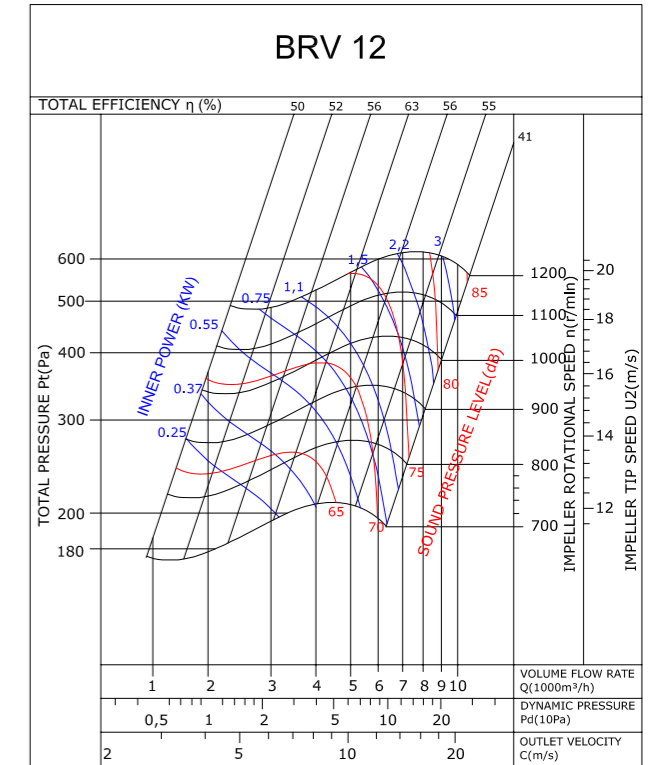
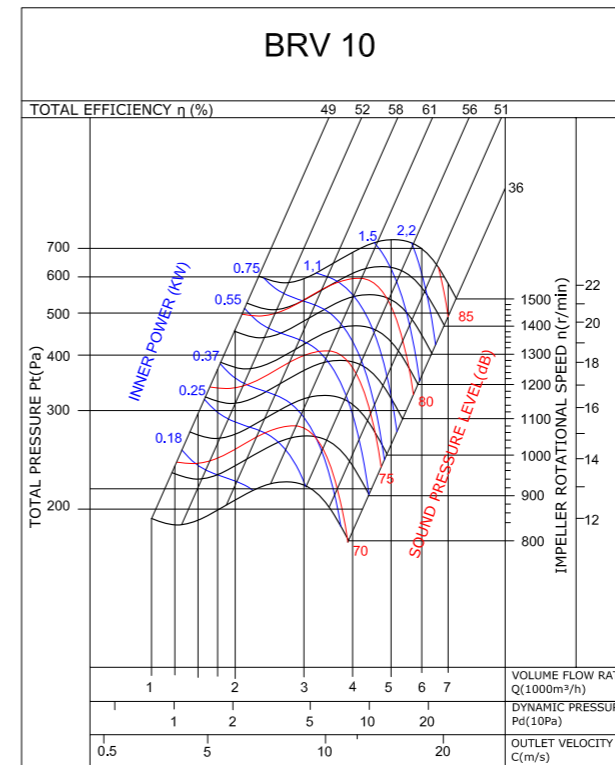
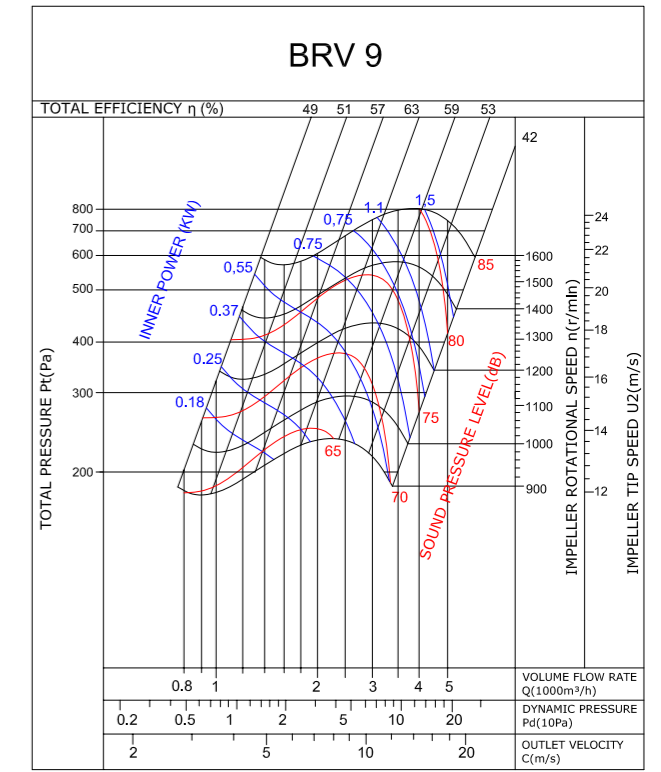
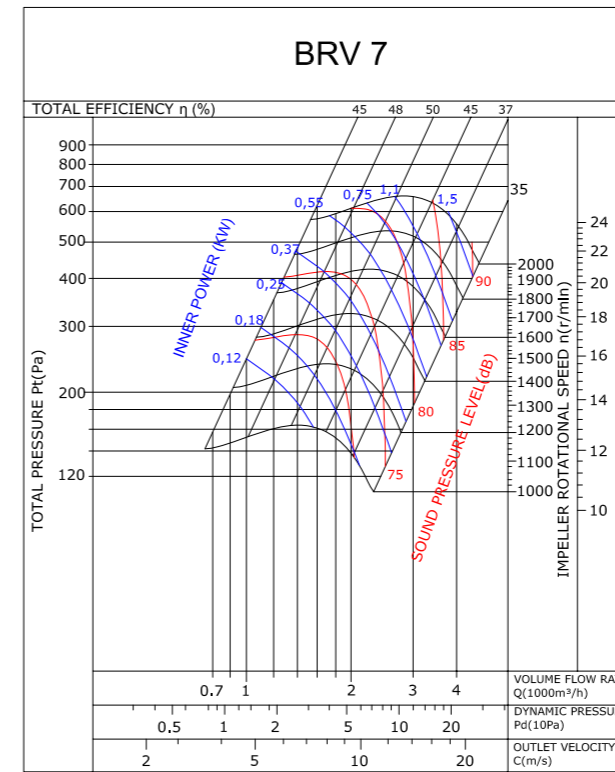

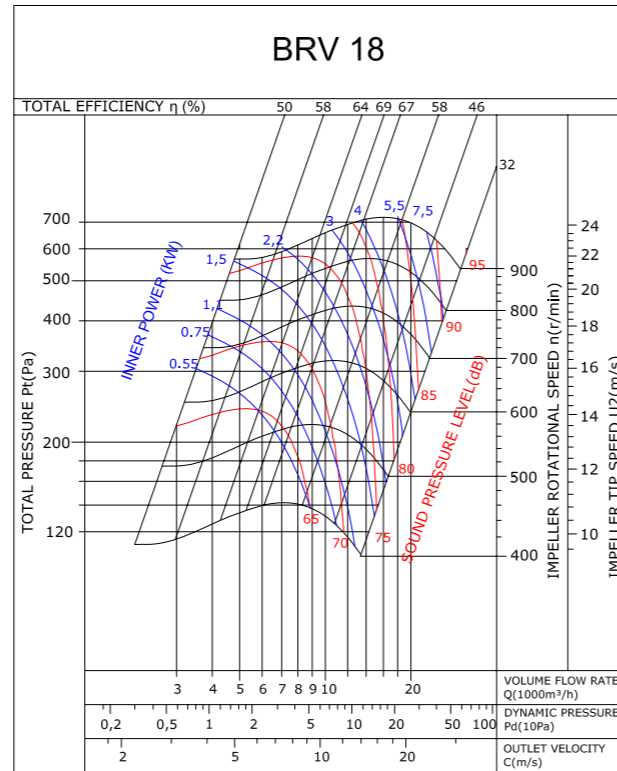
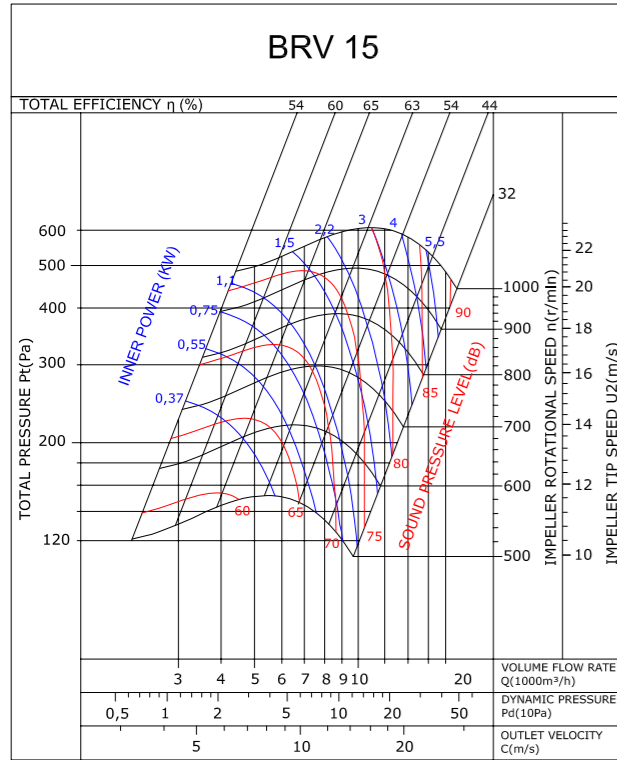

Accessories

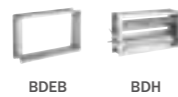

BDD

DOUBLE INLET RADIAL FANS / Forward Curved

Fan Components and Material Properties

Fan Body and fan are made of high quality galvanized steel which is resistant to corrosion. DD double suction centrifugal fans operate at high efficiency. It has a self-asynchronous motor and is connected to the motor frame by steel carriers.

Fan Structure

Double suction, forward-curved low pressure radial type fan. The fan wheel is made of high quality galvanized steel which is resistant to corrosion and is manufactured in aerodynamic structure to ensure regular flow. Thanks to its aerodynamic wing structure, it works quietly.

Benefits

It produces high flow rate with its frequent wing structure. It takes less space than fans with belt-pulley mechanisms; it is easy to assemble. With the mounting legs, the air shot directions can be adjusted. Adjustable with speed control devices.

Speed Control

Optional control devices can be provided. 1~phase products with linear voltage regulator speed control can be done. (see BSC accessory) 3~phase products with frequency inverter speed control can be done. (see BSC-F accessory)

Usage Areas

Box fans, air handling units, fancoils, heat recovery devices and so on. silence, comfort and space saving is preferred.

Technical Drawing and Tables

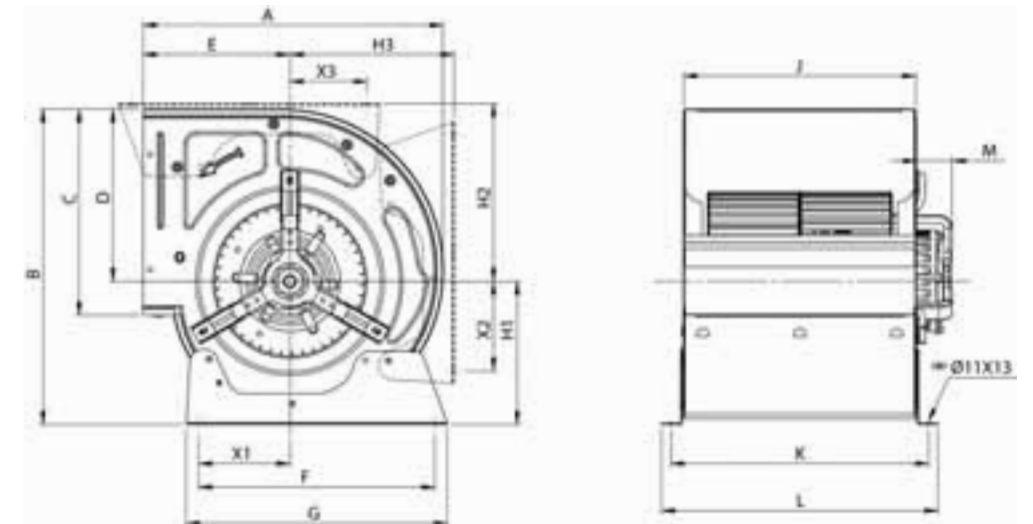

TYPE	A	B	C	D	E	F	G	J	K	L	M	H1	H2	H3	X1	X2	X3
BDD 7-7	313	333	207	190	154	225	250	236	265	288	55	143	195	167	81	93	73
BDD 9-9	381	400	261	218	186	300	330	296	325	350	45	182	245	209	115	115	98
BDD 10-10	425	455	290	250	197	339	370	333	361	386	40	206	258	238	139	145	178
BDD 12-12	490	535	336	292	229	410	440	398	429	454	35	243	292	270	152	140	186

Dimensions are in (mm)

TYPE	VOLTAGE	FREQUENCY	POWER	CURRENT	CAPACITOR	SPEED	AIR FLOW	SOUND PRESSURE	INSULATION CLASS	PROTECTION CLASS	WEIGHT
	V	Hz	W	(A)	(µF)	r.p.m	m³/h	dB(A)	Ins.cl.	IP	kg
BDD 7-7	230	50	147	2,2	10	1300	1800	60	B	54	9
BDD 9-9	230	50	370	3,6	20	1300	2875	62	B	54	13
BDD 10-10	230	50	600	4,2	20	1380	3425	66	B	54	15
BDD 12-12	230	50	1100	5,8	30	900	5180	62	B	54	26

The sound level is measured at a distance of 3 m in open field condition.

Accessories

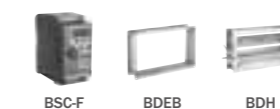

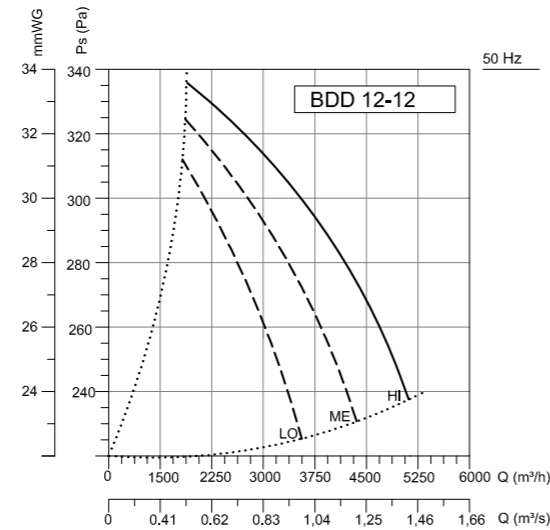
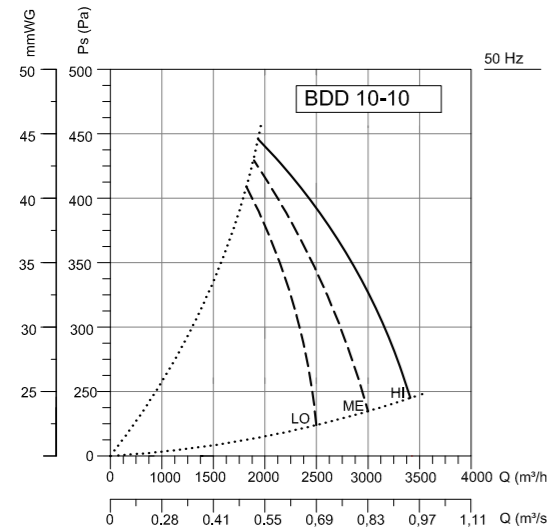
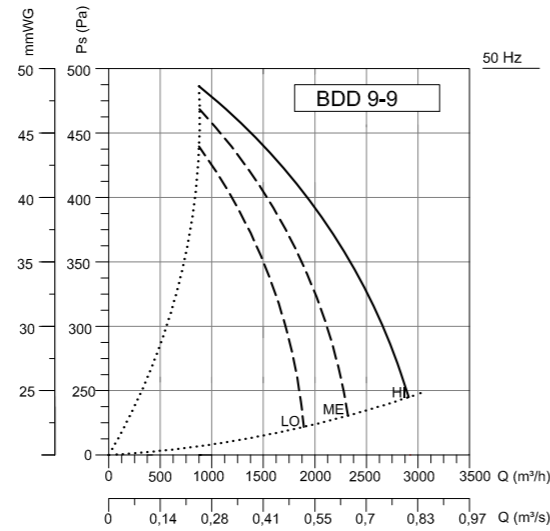
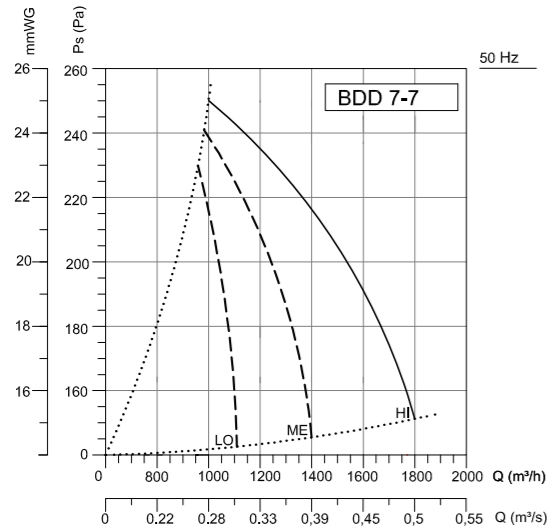

BSF

DOUBLE INLET RADIAL FANS / Backward Curved

Fan Components and Material Properties

The fan housing is made of high quality galvanized steel which is resistant to corrosion. BRV double suction centrifugal fans are produced as standard in various sizes between 1000 m³ / h and 40.000 m³ / h. The motor and fan impeller are produced on the shaft by means of double bearing and main body with steel carriers.

Fan Structure

Double suction, backward curved high pressure radial type fan. The fan wheel is manufactured from high strength resistant welded steel and streamlined to provide regular flow. Thanks to the suitable aerodynamic wing structure, it works silently.

Benefits

Produces high pressure with backward curved blade structure. It can be adjusted with belt pulley drive system or with inverter. They provide maximum performance with low energy. The fan body can rotate the fan rotor at high speeds.

Speed Control

It can be provided with the optional controller. * With belt pulley system or * 3~phase products can be controlled by frequency inverter (see BSC-F accessory)

Usage Areas

Box Fans and air handling units etc. they are preferred.

Technical Drawing and Tables

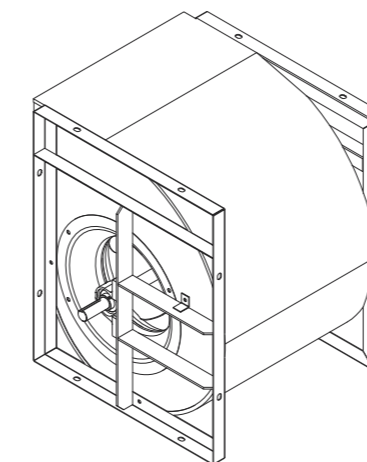
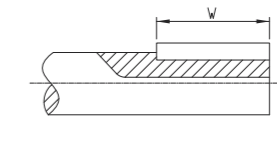
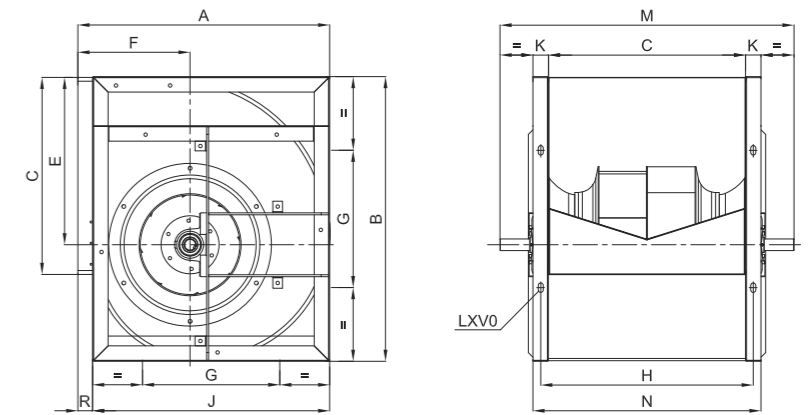
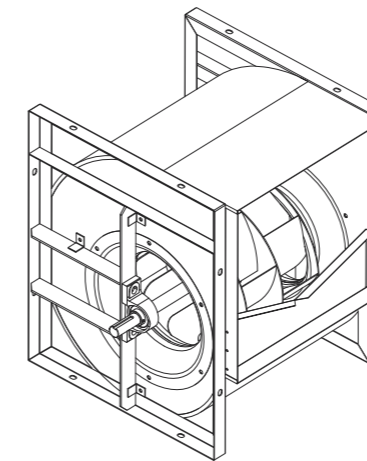

TYPE	AIR FLOW		WEIGHT
	m ³ /h		
BSF 280	6000	22	
BSF 315	8000	33	
BSF 355	10000	45	
BSF 400	15000	52	
BSF 450	18000	68	
BSF 500	26000	85	
BSF 560	32000	140	
BSF 630	40000	170	

Sound Level Measured from 3m distance in room condition.

TYPE	A	B	C	E	F	G	H	J	K	M	N	R	t	t1	W	X	ØD	LXV
BSF 280	466	518	361	302	215	280	391	432	30	540	420	34	8	7	40	28	25	13X18
BSF 315	518	578	404	340	263	330	430	484	30	600	460	34	8	7	40	28	25	13X18
BSF 355	578	655	453	384	261	355	490	548	32	700	520	34	8	7	40	33	30	13X18
BSF 400	651	736	507	432	290	355	549	613	40	760	589	38	8	7	40	33	30	13X18
BSF 450	727	832	569	487	322	530	611	681	40	845	613	46	10	8	50	38	35	13X18
BSF 500	806	920	640	544	352	610	695	754	45	924	736	52	10	8	50	38	35	13X18
BSF 560	894	1031	718	609	390	685	777	842	50	1000	819	52	12	8	70	43	40	13X18
BSF 630	996	1157	801	685	434	766	866	946	50	1092	907	52	12	8	70	43	40	13X18

Dimensions are in (mm)

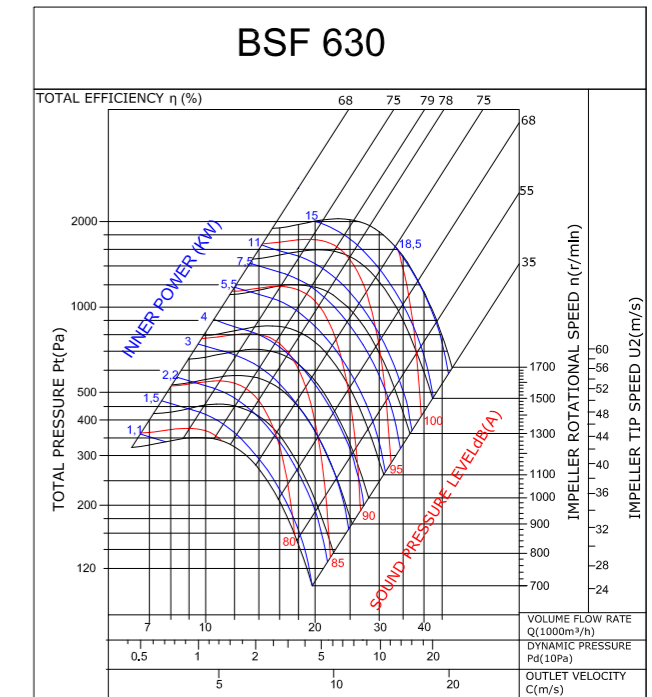
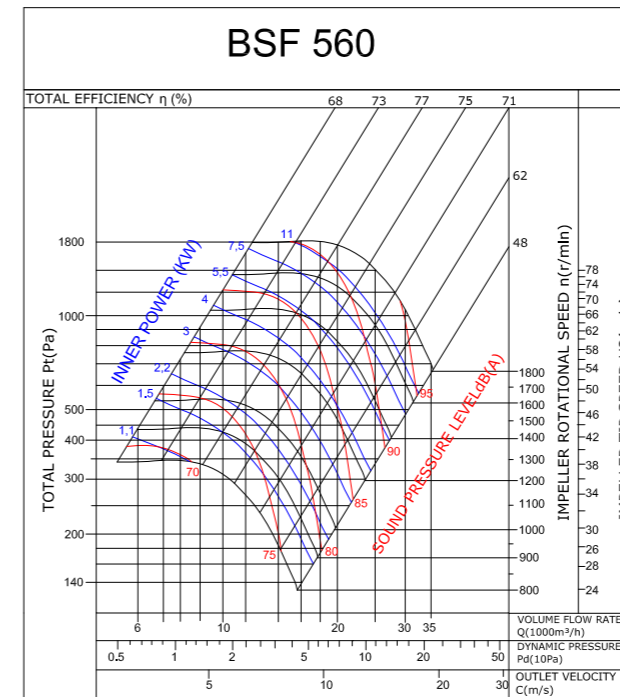
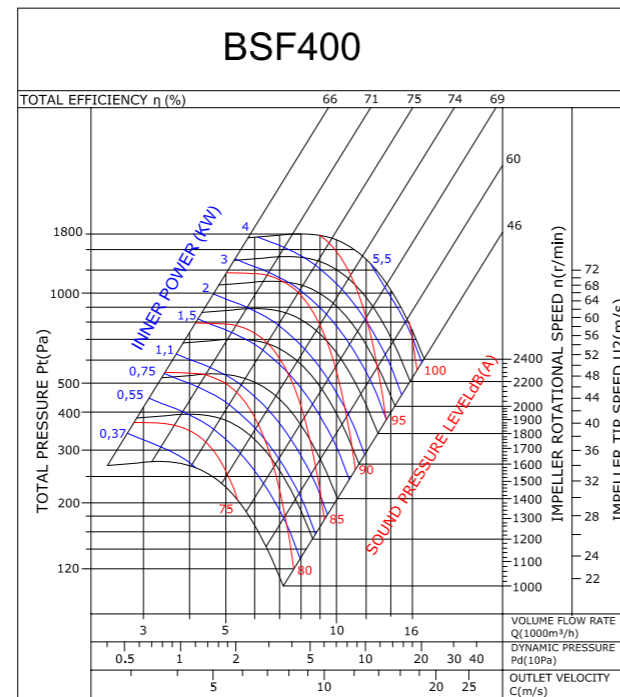
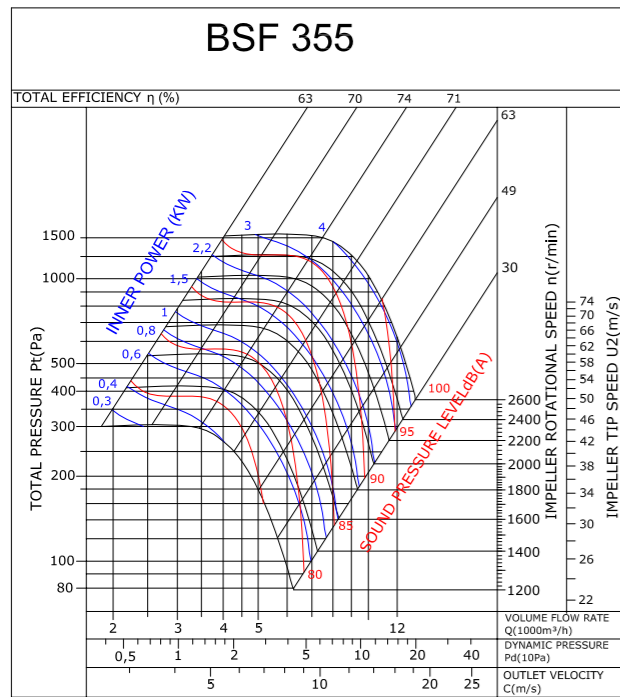
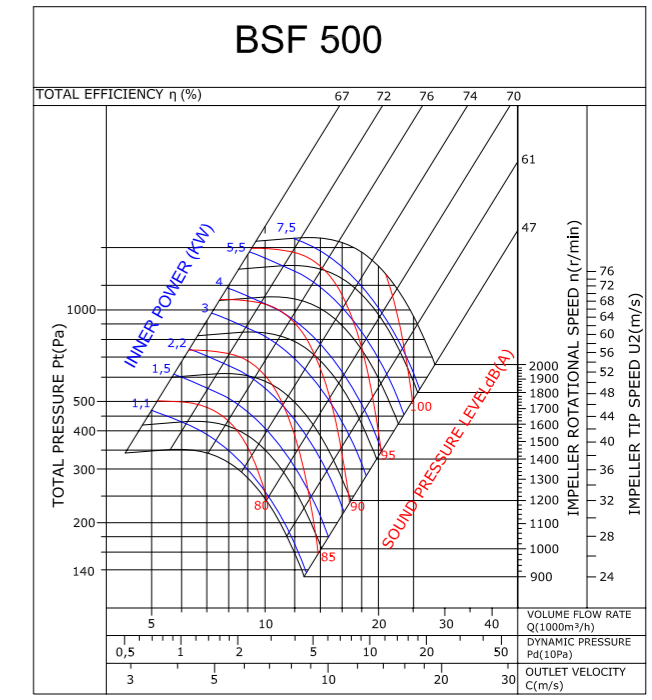
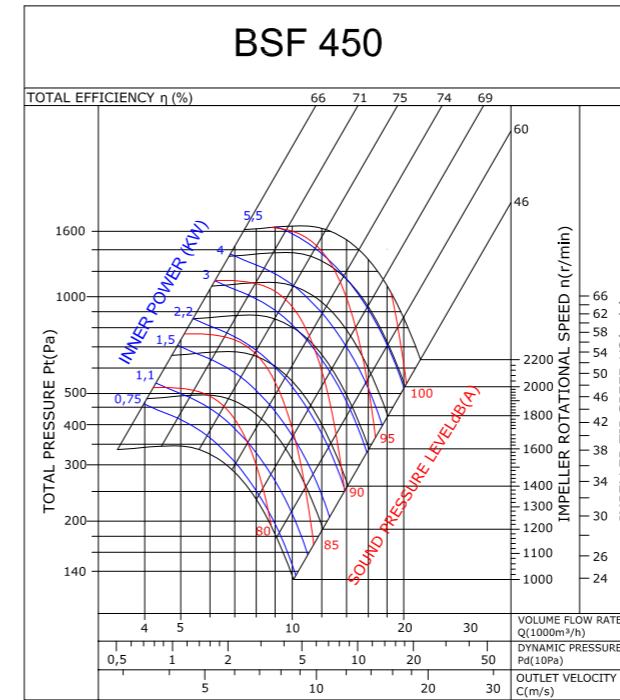
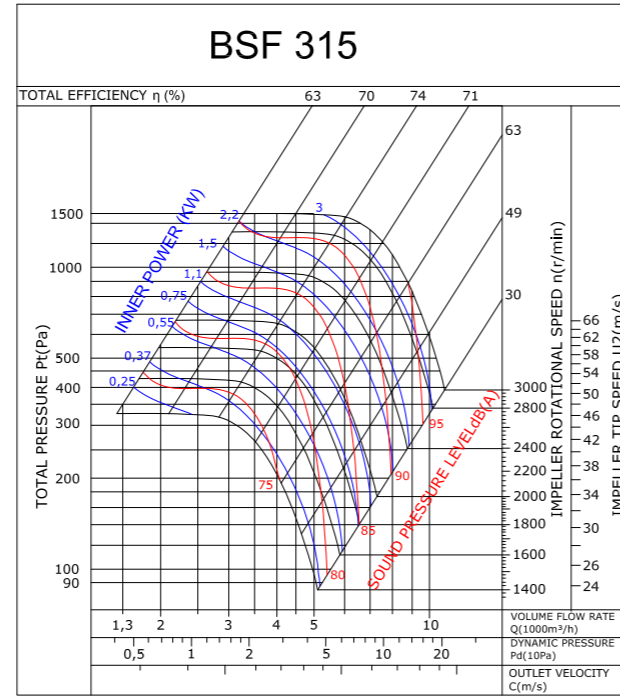
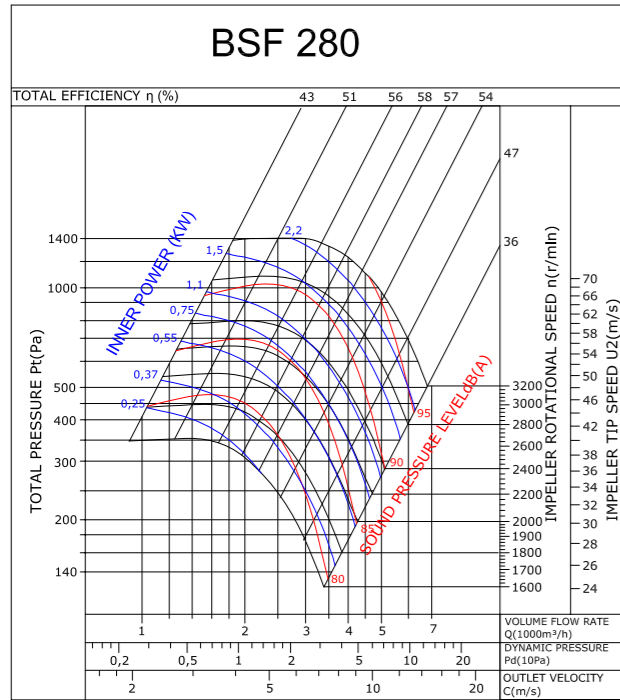

Accessories

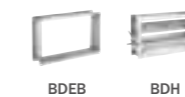



OÇES

DOUBLE INLET RADIAL FANS / Forward Curved

Fan Components and Material Properties

OÇES radial fan body is made of DKP sheet metal with electrostatic powder coating, the fans operate at high efficiency and low noise level. Uses asynchronous motor and device max. It is capable of carrying air at a temperature of 40°C.

Fan Structure

It has double suction and forward curved radial fan type. The fan wheel is made of high quality galvanized steel which is resistant to corrosion and is manufactured in aerodynamic structure to ensure regular flow. Thanks to its aerodynamic wing structure, it works quietly.

Benefits

It works with low noise levels and is designed to

be maintenance-free for long periods of time. Due to its frequent wing structure and efficient motor, it produces high flow rate and pressure compared to its dimensions. Provides advantages in areas where space is limited. Speed adjustable with speed control devices.

Speed Control

Optional control devices can be provided. 1-phase products with linear voltage regulator speed control can be done. (see BSC accessory)

Usage Areas

Greenhouses, factories, warehouses, paint shops, shopping centers, factories, plastic and packaging machines etc. It is used for ventilation of large places.

Technical Drawing and Tables

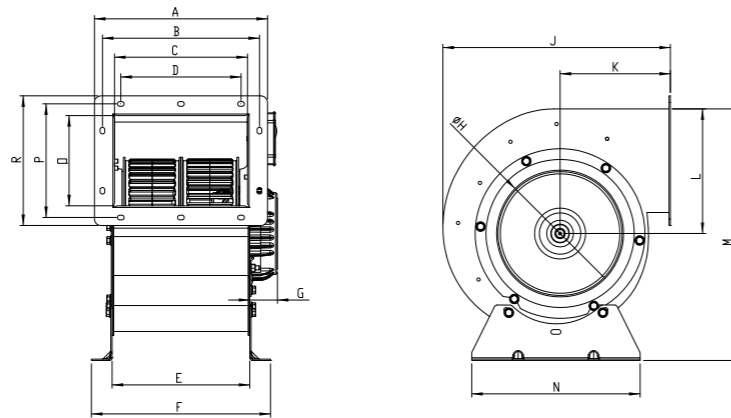

TYPE	A	B	C	D	E	F	G	H	J	K	L	M	N	O	P	R
OÇES	258	234	197	180	210	269	41	190	339	160	189	396	252	133	169	194

Dimensions are in (mm)

TYPE	VOLTAGE	FREQUENCY	POWER	CURRENT	CAPACITOR	SPEED	AIR FLOW	SOUND PRESSURE	INSULATION CLASS	PROTECTION CLASS	WEIGHT
	V	Hz	W	(A)	(µF)	r.p.m	m ³ /h	dB(A)	Ins.cl.	IP	kg
OÇES	230	50	400	1,8	10	1250	2200	45	B	44	10,3

The sound level is measured at a distance of 3 m in open field condition.

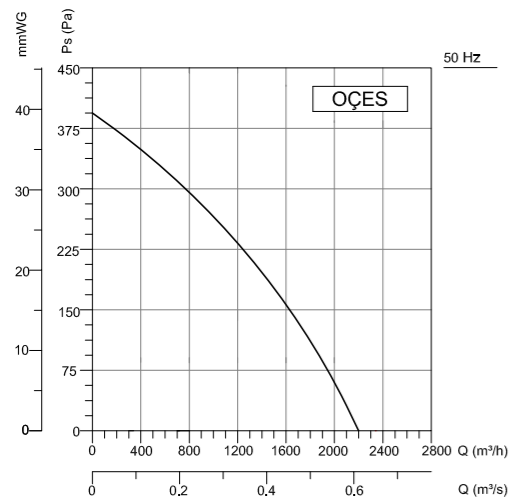

Accessories

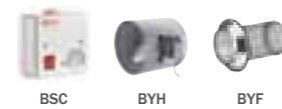

ÇES

DOUBLE INLET RADIAL FANS / Forward Curved

Fan Components and Material Properties

ÇES radial fan body is made of DKP sheet metal with electrostatic powder coating, fans operate at high efficiency and low noise level. Uses asynchronous motor and device max. It is capable of carrying air at a temperature of 40°C.

Fan Structure

It has double suction and forward curved radial fan type. The fan wheel is made of high quality galvanized steel which is resistant to corrosion and is manufactured in aerodynamic structure to ensure regular flow. Thanks to its aerodynamic wing structure, it works quietly.

Benefits

It works with low noise levels and is designed to

be maintenance-free for long periods of time. Due to its frequent wing structure and efficient motor, it produces high flow rate and pressure compared to its dimensions. Provides advantages in areas where space is limited. Speed adjustable with speed control devices.

Speed Control

Optional control devices can be provided. * Speed control can be done with linear voltage regulator. (see BSC accessory)

Usage Areas

Greenhouses, factories, warehouses, paint shops, shopping centers, factories, plastic and packaging machines etc. It is used for ventilation of large places.

Technical Drawing and Tables

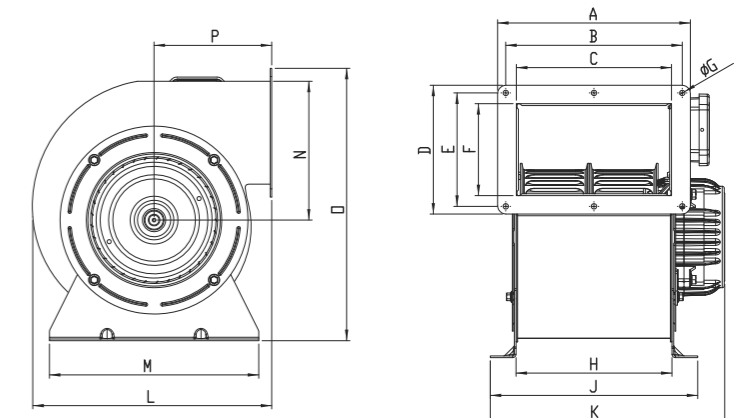

TYPE	A	B	C	D	E	F	G	H	J	K	L	M	N	O	P
ÇES	232	213	187	155	137	111	7	188	250	282	288	252	167	328	142

Dimensions are in (mm)

TYPE	VOLTAGE	FREQUENCY	POWER	CURRENT	CAPACITOR	SPEED	AIR FLOW	SOUND PRESSURE	INSULATION CLASS	PROTECTION CLASS	WEIGHT
	V	Hz	W	(A)	(µF)	r.p.m	m ³ /h	dB(A)	Ins.cl.	IP	kg
ÇES	230	50	217	1,1	8	1420	1300	46	B	44	9

The sound level is measured at a distance of 3 m in open field condition.

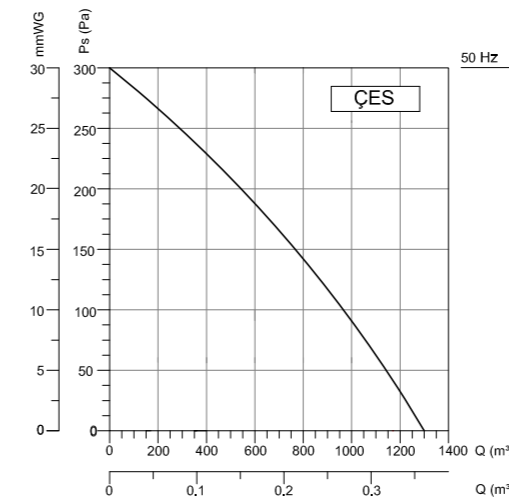

Accessories





BDRKF

BACKWARD CURVED FANS

Fan Components and Material Properties

The fan is made of high quality galvanized steel which is resistant to corrosion. Some models can also be manufactured in plastic or aluminum to meet application and performance requirements. All fans have an external rotor motor that creates a compact structure and have air transport at max.40°C. Motors are mounted to the fan by means of tight fitting or fasteners. Thanks to the holes on the motor cover, it can be mounted easily on the surface. The suction flange is available as an option.

Fan Structure

The fan blades are aerodynamically curved and provide regular flow. The fans are composed of backward sloping and infrequently arranged fins.

Benefits

The rotation of the fan on the motor housing saves efficiency and space. It works at optimum sound levels while providing strong air suction. It can be operated in any position. Speed can be adjusted with speed control devices.

Speed Control

Optional control devices can be provided. 1 ~ Phase products can be controlled with linear voltage regulator. (see BSC accessory) Speed control can be done with frequency inverter in 3 ~ phase products. (see BSC-F accessory)

Usage Areas

They are used in air-conditioning devices and duct fans.

Technical Drawing and Tables

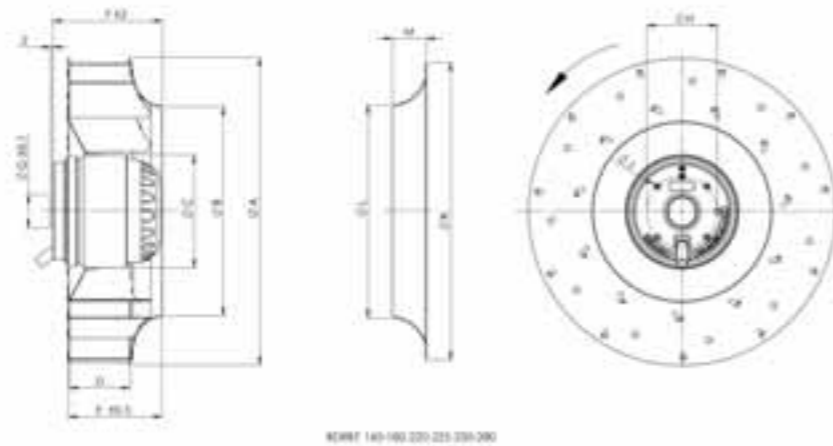

TYPE	A	B	C	D	E	F	G	H	J	K	L	M
BDRKF 160	162	121,5	92	40	60	75	27	58	M4	168	113	16
BDRKF 180	180	121,5	92	40	60	83	27	58	M4	168	113	16
BDRKF 220	220	159	92	44	63	73	27	58	M4	204	147	20
BDRKF 225	227	153	92	50	76	102	27	58	M4	204	147	20
BDRKF 250	252	172,5	92	50	79	92	27	58	M4	225	165	20
BDRKF 280	281	190	92	50	85	112	27	58	M4	245	173	20

Dimensions are in (mm)

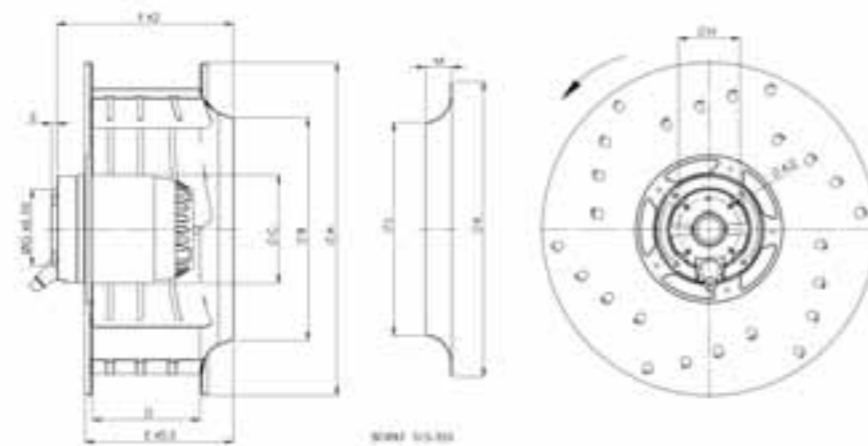

TYPE	A	B	C	D	E	F	G	H	J	K	L	M
BDRKF 315	316	211	102	102	141	160	75	90	M6	280	200	20
BDRKF 355	356	247	102	102	145	164	75	90	M6	310	236	20

Dimensions are in (mm)

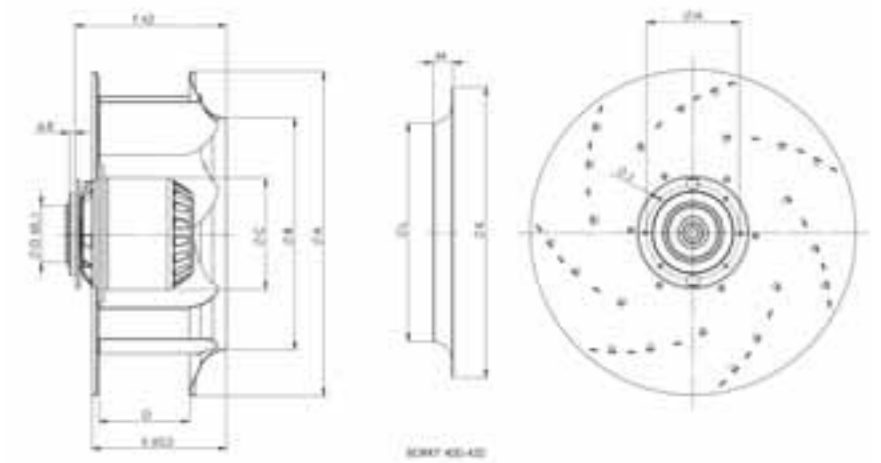

TYPE	A	B	C	D	E	F	G	H	J	K	L	M
BDRKF 400	404	286	138	112	166	197	100	115	M6	360	270	25
BDRKF 450	455	319	138	125	185	217	100	115	M6	382	305	25
BDRKF 500T	505	354	138	140	220	241	100	115	M6	460	344	45

Dimensions are in (mm)

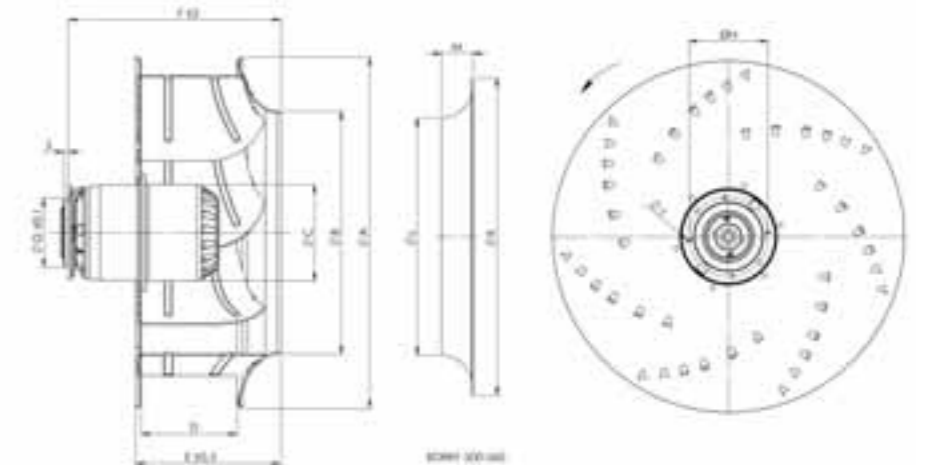

TYPE	A	B	C	D	E	F	G	H	J	K	L	M
BDRKF 500M	505	354	138	140	220	290	100	115	M6	460	344	45
BDRKF 560	565	398	138	160	233	330	100	115	M6	518	382	45

Dimensions are in (mm)

TYPE	VOLTAGE	FREQUENCY	POWER	CURRENT	CAPACITOR	SPEED	AIR FLOW	SOUND PRESSURE	INSULATION CLASS	PROTECTION CLASS	WEIGHT	PIECES IN BOX
	V	Hz	W	(A)	(µF)	r.p.m	m³/h	dB(A)	Ins.cl.	IP	kg	AD
BDRKF 160-M	230	50/60	65/75	0,29/0,33	2	2500/2750	346/380	44	B	44	1,4	8
BDRKF 180-M	230	50/60	80/100	0,35/0,44	2,5	2400	500	52	B	44	1,6	8
BDRKF 220-A-M	230	50/60	65/75	0,30/0,35	1,5	2100	700	53	B	44	1,8	8
BDRKF 220-B-M	230	50/60	100/120	0,44/0,53	3	2450/2750	860/965	54	B	44	1,9	8
BDRKF 225-M	230	50/60	100/135	0,46/0,62	4	2650/2950	1000/1100	54	B	44	2,3	8
BDRKF 250-M	230	50/60	155/225	0,72/1	6	2600/2800	1400/1500	54	B	44	2,8	8
BDRKF 280-M	230	50/60	200/275	0,89/1,23	7	2600	1850	55	B	44	3,3	8
BDRKF 315-M	230	50/60	175/185	0,97/0,81	6	1450/1720	2200/2500	53	F	44	5,8	1
BDRKF 355-M	230	50/60	200/250	0,82/1,1	6	1400/1650	3100/3600	55	F	44	6,5	1
BDRKF 400-M	230	50/60	275/400	1,39/1,9	10	1400/1650	4300/5000	60	F	44	10	1
BDRKF 450-M	230	50/60	390/615	1,97/2,92	10	1350/1600	5750/6800	62	F	44	12	1
BDRKF 500-M	230	50	780	3,5	16	1280	7600	64	F	44	17	1
BDRKF 500-T	380Δ/Y	50	760/550	1,7/0,9	-	1350/1100	8200/6680	64	F	44	17	1
		60	920/660	2,1/1,2	-	1500/1100	9100/6680					
BDRKF 560-M	230	50	1550	7,3	25	1250	10150	66	F	44	22	1
BDRKF 560-T	380Δ/Y	50	1150/720	2,3/1,3	-	1350/1050	11000/8550	66	F	44	22	1

Sound Level Measured from 3m distance in room condition.

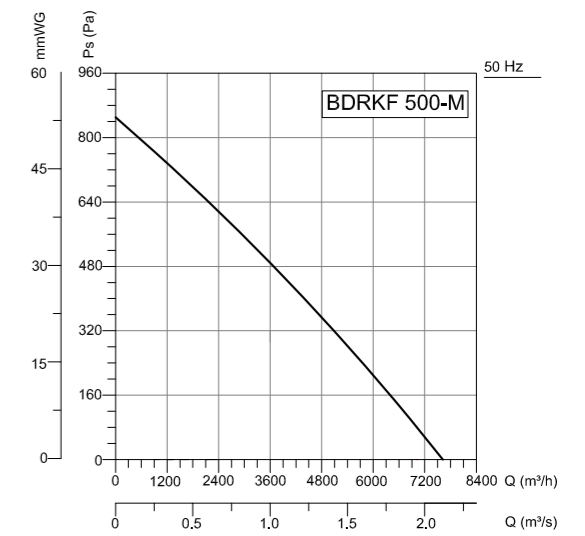
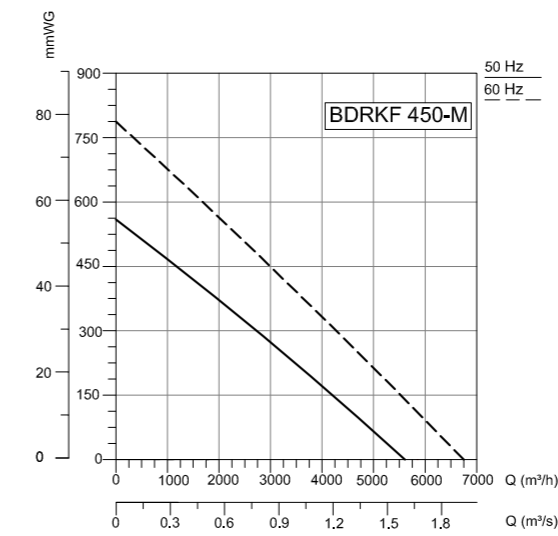
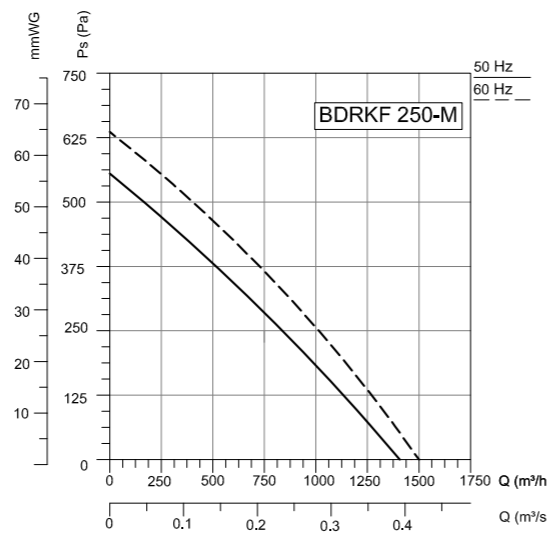
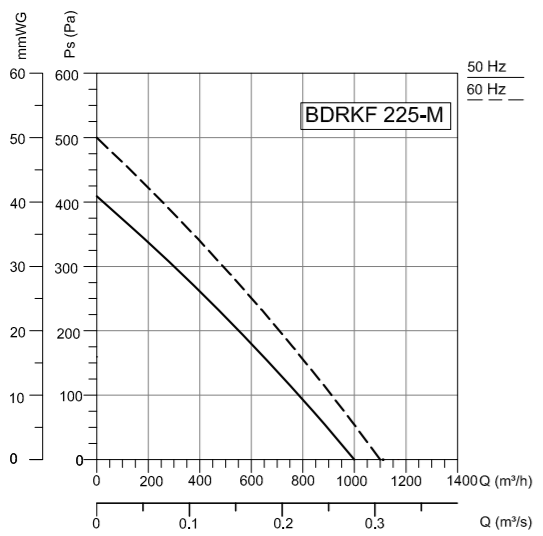
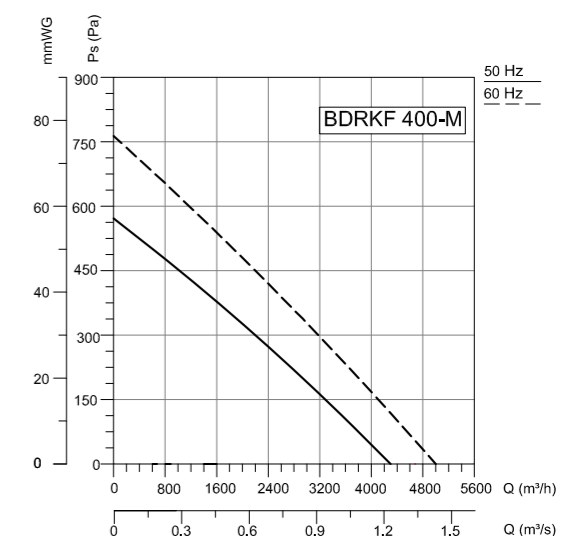
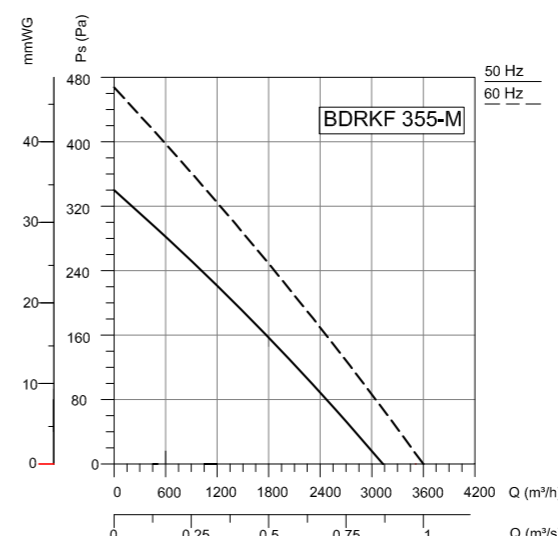
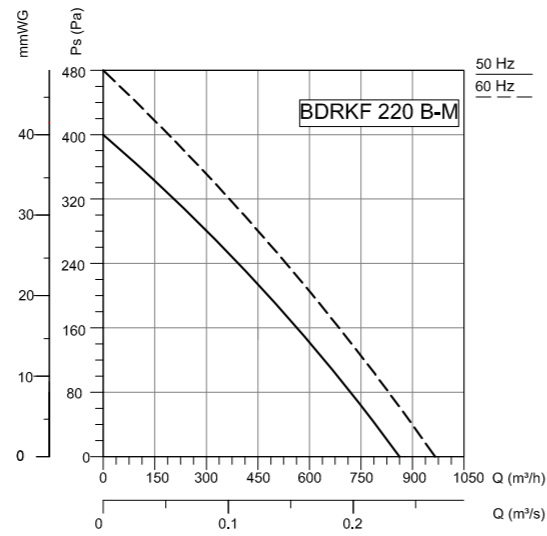
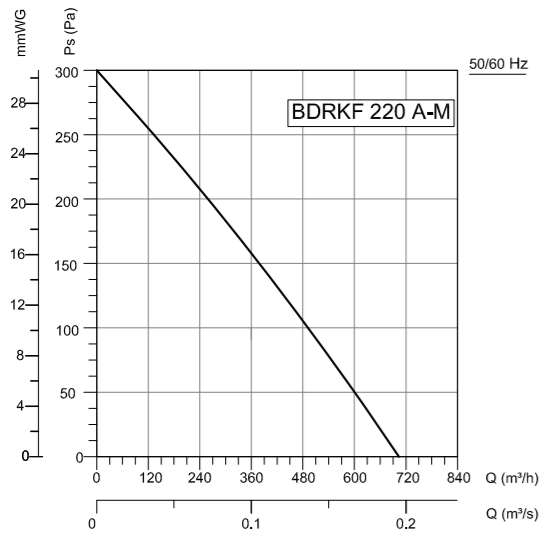
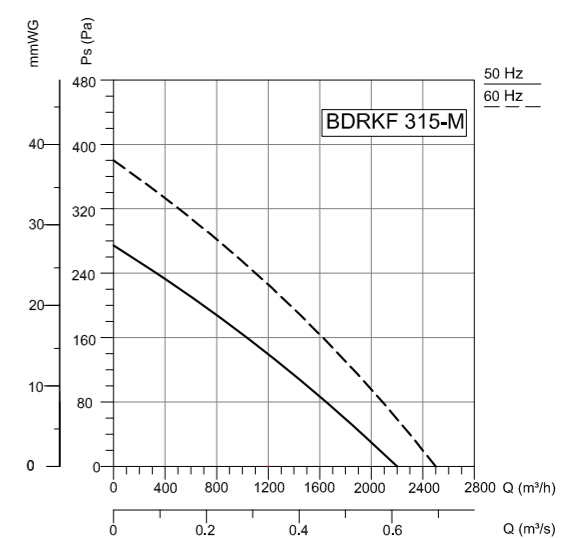
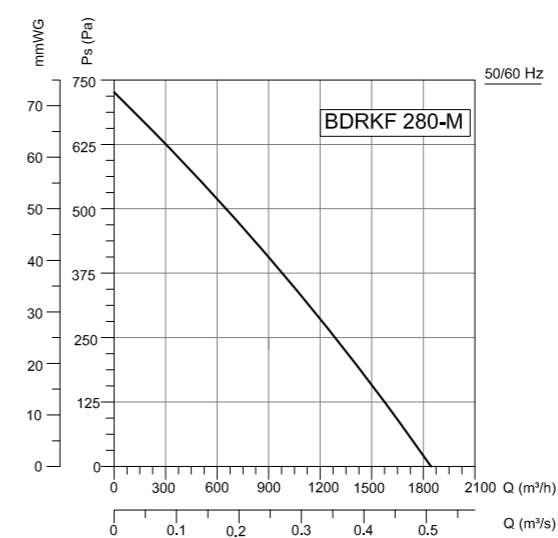
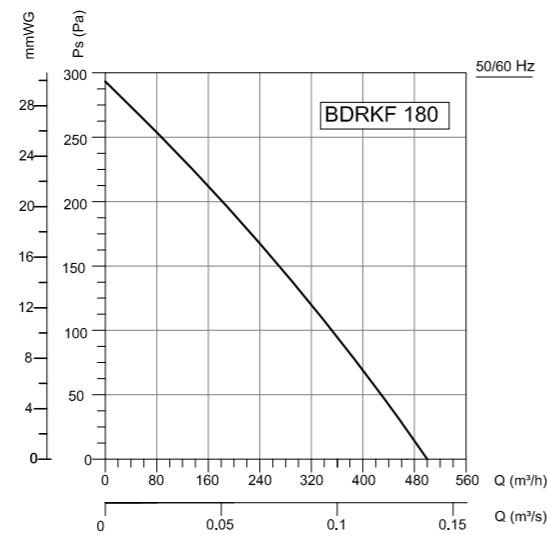
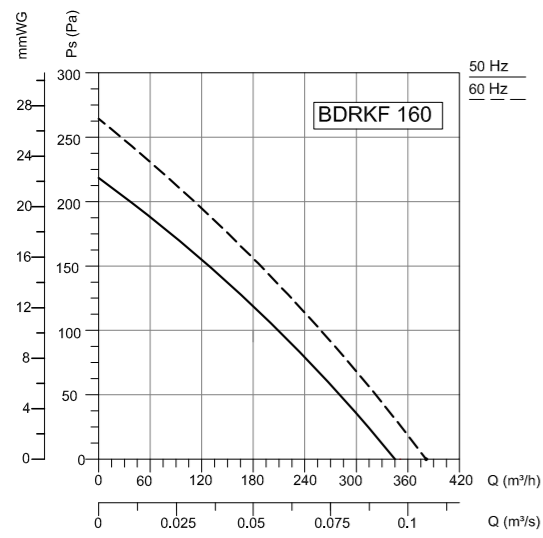

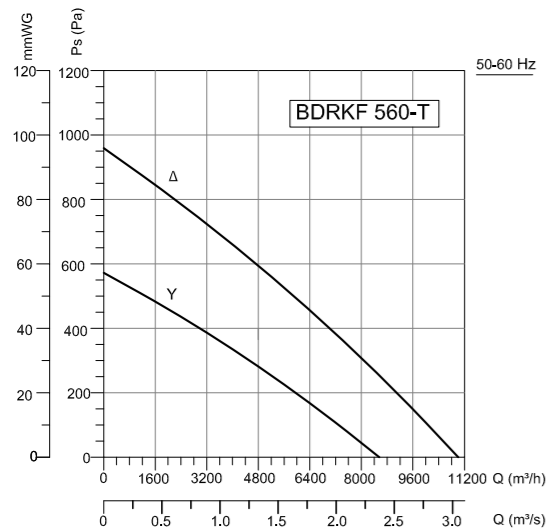
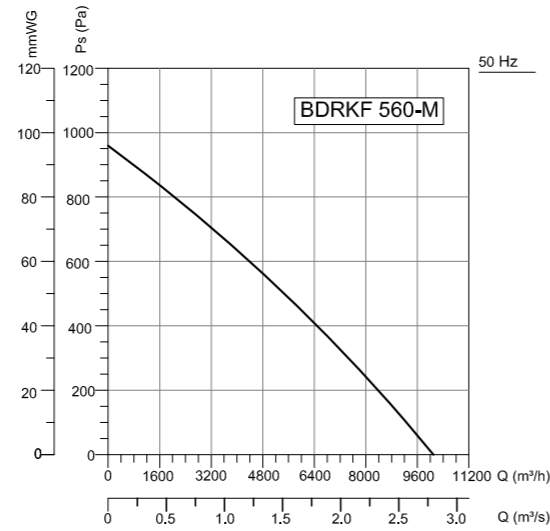
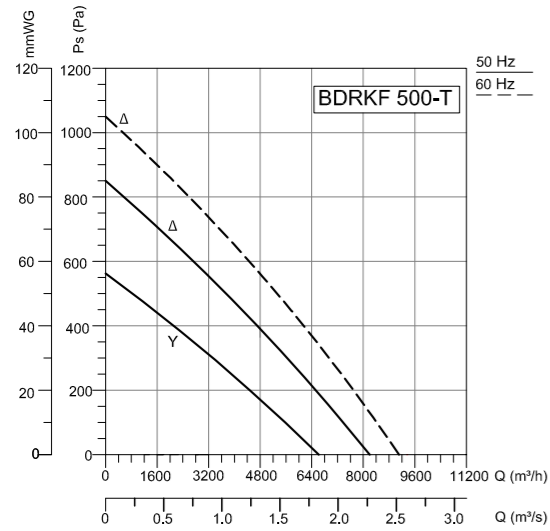

Accessories



BASSF
FORWARD CURVED FANS

Fan Components and Material Properties

BASSF fans are made of high quality galvanized steel which is resistant to corrosion. The external rotor motor is used to create a compact structure and the device is max. It is capable of carrying air at a temperature of 40°C.

Fan Structure

The forward sloped fan wheel is made of high quality galvanized steel which is resistant to corrosion and they are manufactured in aerodynamic structure to ensure regular flow. Thanks to its aerodynamic wing structure, it works quietly.

Benefits

It works with low noise levels and is designed to be maintenance-free for long periods of time. It offers space saving according to its capacity.

Due to its frequent wing structure and efficient motor, it produces high flow rate and pressure compared to its dimensions. Provides advantages in areas where space is limited. Speed can be adjusted with speed control devices.

Speed Control

Optional control devices can be provided. 1-phase products with linear voltage regulator speed control can be done. (see BSC accessory) 3-phase products with frequency inverter speed control can be done. (see BSC-F accessory)

Usage Areas

In radial fans, duct fans, cooling of various machines, air circulation in air-conditioners etc. used in areas.

Technical Drawing and Tables

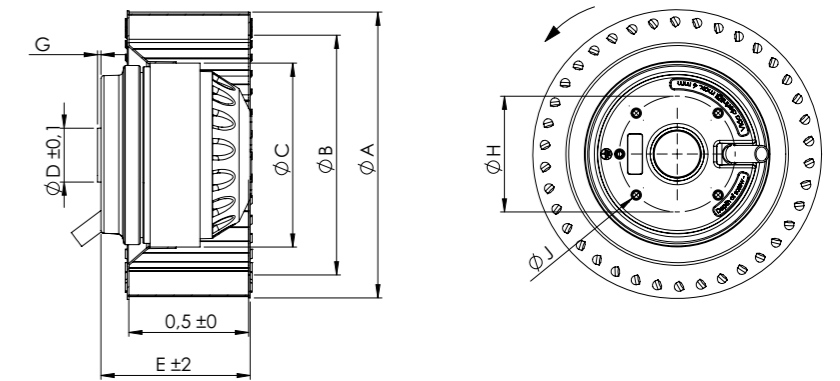

TYPE	A	B	C	D	E	F	G	H	J
BASSF 120-60	120	102	92	27	78	62	2	58	M4
BASSF 140-60	140	124	92	27	80	59	2	58	M4
BASSF 160-60	160	137	92	27	83	62	2	58	M4

Dimensions are in (mm)

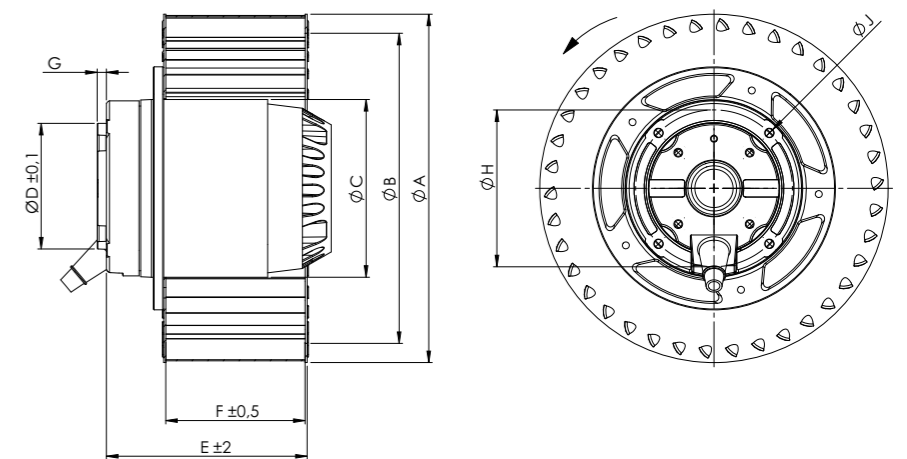

TYPE	A	B	C	D	E	F	G	H	J
BASSF 200-90	200	172	102	74	114	80	5	90	M6

Dimensions are in (mm)

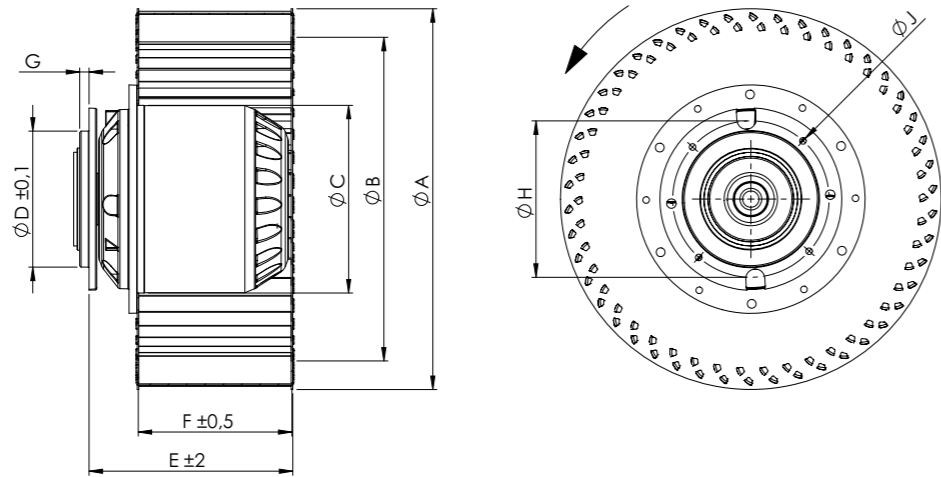

TYPE	A	B	C	D	E	F	G	H	J
BASSF 225-90	225	179	138	100	136	90	6,5	115	M6
BASSF 250-100	250	203	138	100	144	98	6,5	115	M6
BASSF 280-112	280	234	138	100	148	112	6,5	115	M6
BASSF 315-125	315	259	138	100	171	125	6,5	115	M6

Dimensions are in (mm)

TYPE	VOLTAGE	FREQUENCY	POWER	CURRENT	CAPACITOR	SPEED	AIR FLOW	SOUND PRESSURE	INSULATION CLASS	PROTECTION CLASS	WEIGHT
	V	Hz	W	(A)	(μ F)	r.p.m	m ³ /h	dB(A)	Ins.cl.	IP	kg
BASSF 120-60	230	50/60	70/80	0,31/0,35	2,5	2700/3100	275/315	45	B	44	1,4
BASSF 140-60	230	50/60	110/145	0,49/0,65	4	2600/2900	485/540	47	B	44	1,8
BASSF 160-60	230	50/60	165/230	0,73/1,03	6	2600/2750	600/635	50	B	44	2,1
BASSF 200-90	230	50/60	200/240	0,9/1,1	6	1250/1450	1000/1160	53	F	44	12
BASSF 225-90	230	50/60	230/275	0,15/0,18	8	1400/1600	1600/1800	55	F	44	16
BASSF 250-100	230	50	295	2,1	14	1250	1900	58	F	44	19
BASSF 280-112	380	50	950	2,6	-	1350	2850	58	F	44	23
BASSF 315-125	380	50	1230	2,7	-	1280	4000	61	F	44	33

Sound Level Measured from 3m distance in room condition.

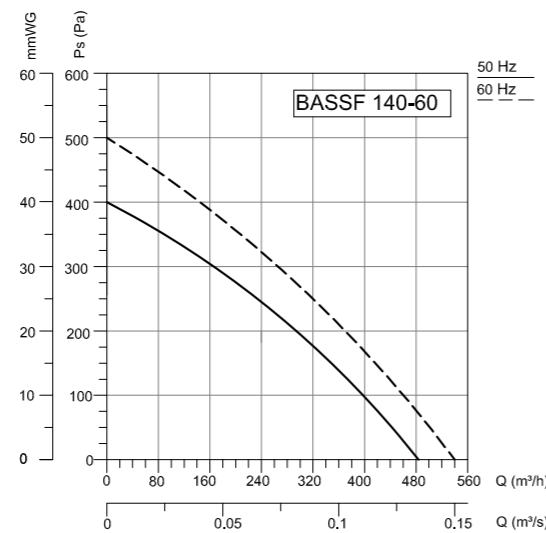
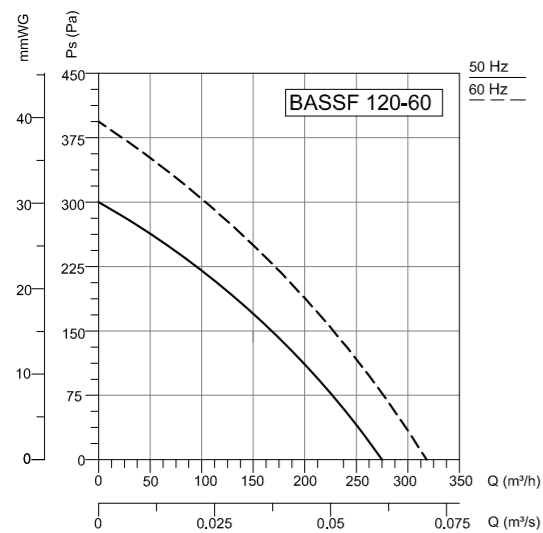
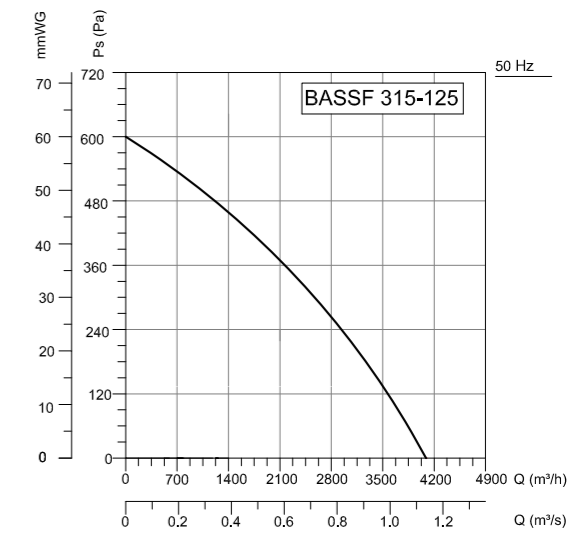
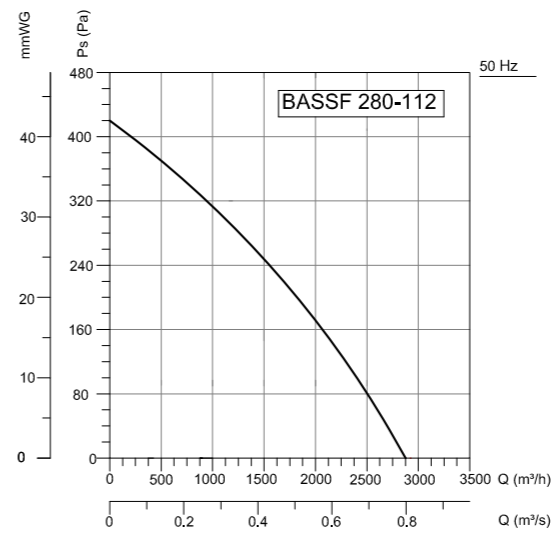
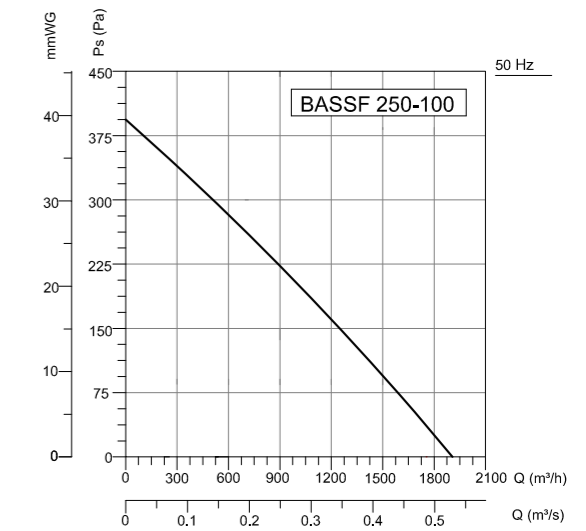
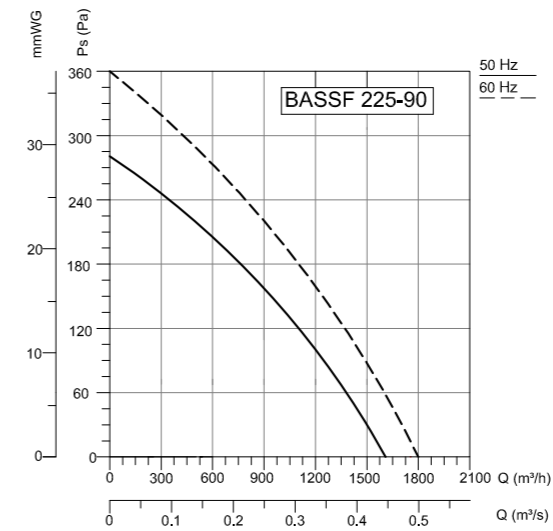
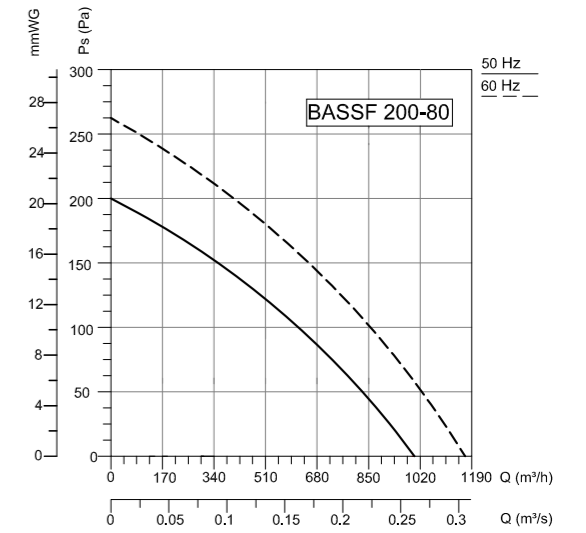
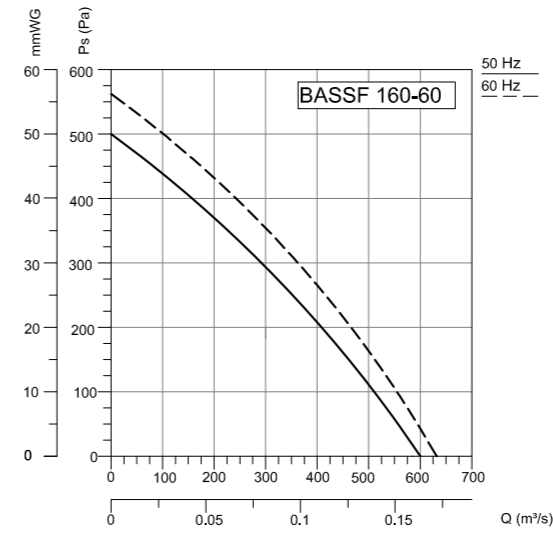

Accessories



BSC

BSC-F

BATHROOM FANS (Plastic Fans)

Fans can be easily mounted to the ceiling, wall, window, and ducts with their stylish designs and are used in areas such as the bathroom, toilet, warehouse. They are resistant to corrosion.

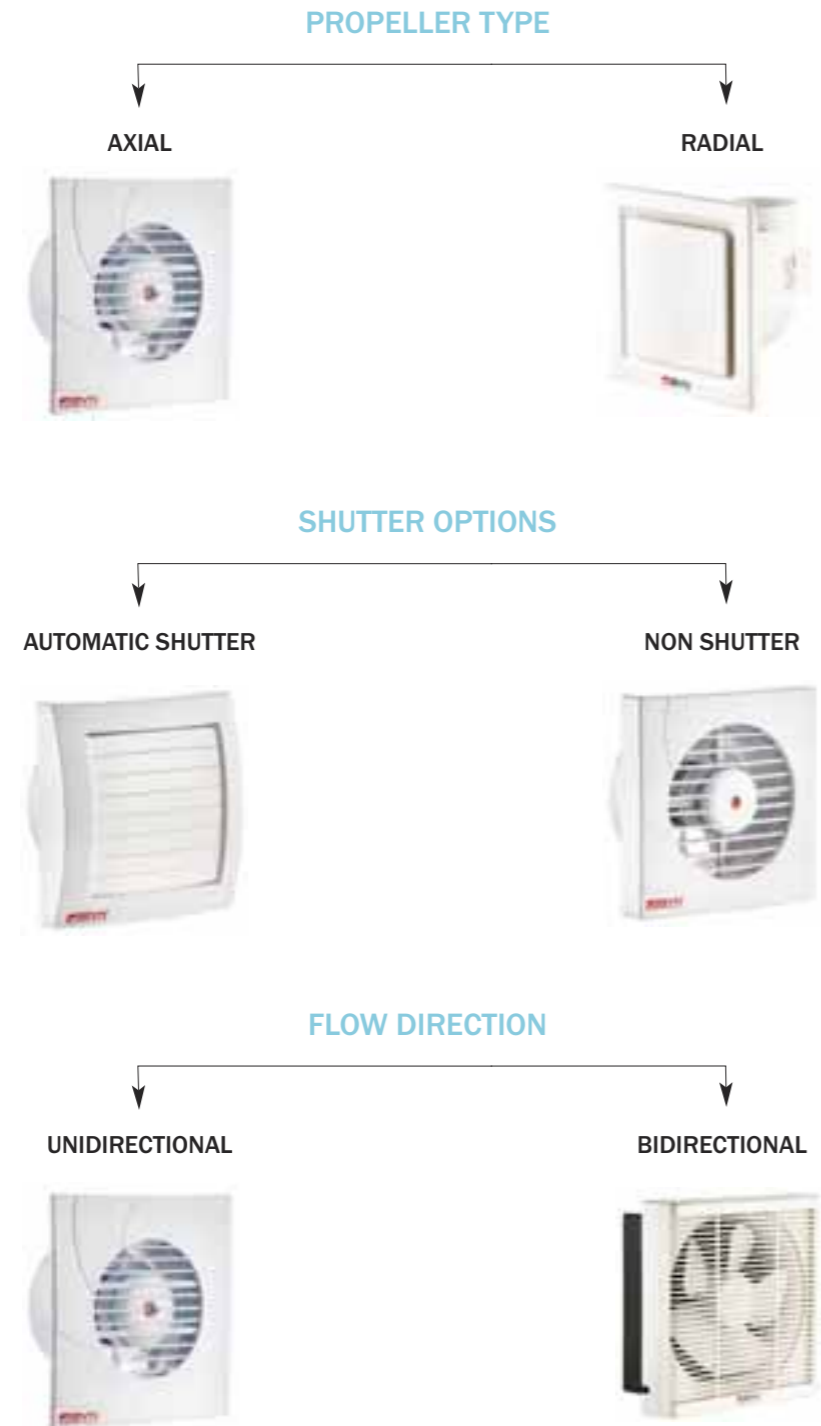



EF

AXIAL BATHROOM FANS / *Decoratife*

The front panel is thin and tight. This feature provides a robust mounting design. It is silent and corrosion resistant. Long life of the motor against environmental factors. Thermal protection.

Can be mounted on glass and wall. It is used for small volume spaces, bath and toilet ventilation.

Technical Drawing and Tables

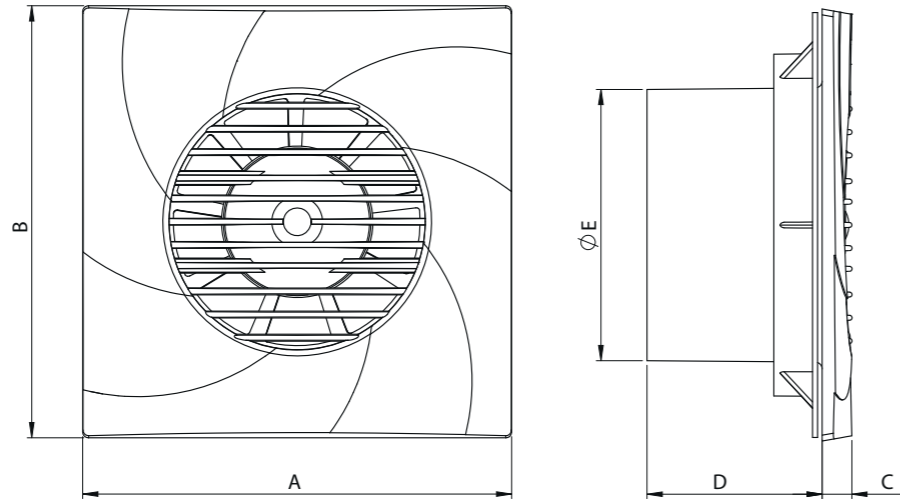

TYPE	A	B	C	D	E
EF 1009	160	160	12	70	97.5
EF 1219	188	188	14	76	118
EF 1530	208	208	14	118	145

Dimensions are in (mm)

TYPE	VOLTAGE	FREQUENCY	POWER	CURRENT	CAPACITOR	SPEED	AIR FLOW	SOUND PRESSURE	INSULATION CLASS	PROTECTION CLASS	WEIGHT	PIECES IN BOX
	V	Hz	W	(A)	(μ F)	r.p.m	m ³ /h	dB(A)	Ins.cl.	IP	kg	AD
EF 1009	230	50/60	13	0,09	-	2600	100	40	B	20	0,5	24
EF 1219	230	50/60	14	0,09	-	2400	200	41	B	20	0,55	20
EF 1530	230	50/60	21	0,13	-	2000	300	43	B	20	0,71	16

Sound Level Measured from 3m distance in room condition.

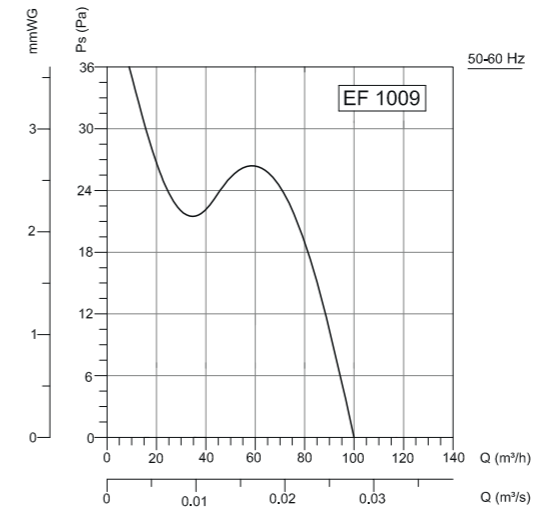

Frequency	Tot	63	125	250	500	1000	2000	4000	8000	Hz
L _{WA} Inlet	47	11	35	41	43	40	36	34	27	dB(A)
L _{WA} Outlet	56	36	49	52	52	42	38	34	25	dB(A)

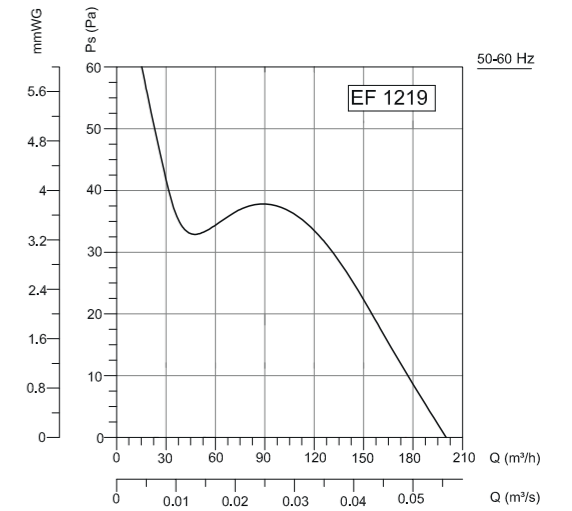

Frequency	Tot	63	125	250	500	1000	2000	4000	8000	Hz
L _{WA} Inlet	48	15	41	42	41	40	38	31	24	dB(A)
L _{WA} Outlet	59	56	52	53	50	43	40	29	22	dB(A)

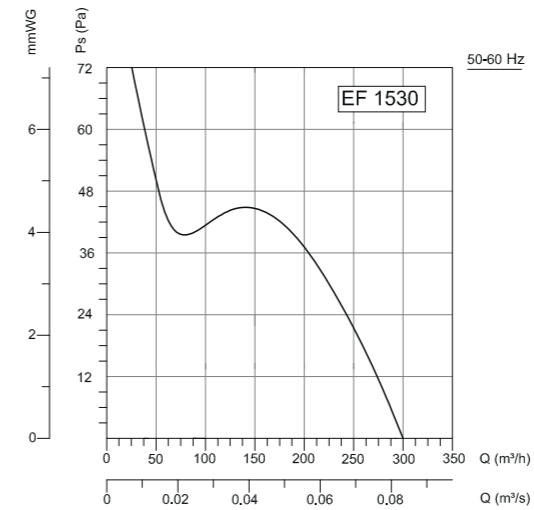

Frequency	Tot	63	125	250	500	1000	2000	4000	8000	Hz
L _{WA} Inlet	50	18	37	45	45	43	40	33	25	dB(A)
L _{WA} Outlet	57	36	49	55	49	40	40	32	20	dB(A)

Accessories



BSC





EC

AXIAL BATHROOM FANS / Automatic Shutter

Automatic roller shutter. It is safe with front louvre design. It is silent and corrosion resistant. Long life of the motor against environmental factors. Thermal protection.

Thanks to the automatic blinds, it prevents the ingress of air and foreign bodies from outside. Can be mounted on glass and wall. Used for small volume spaces, bath and toilet ventilation.

Technical Drawing and Tables

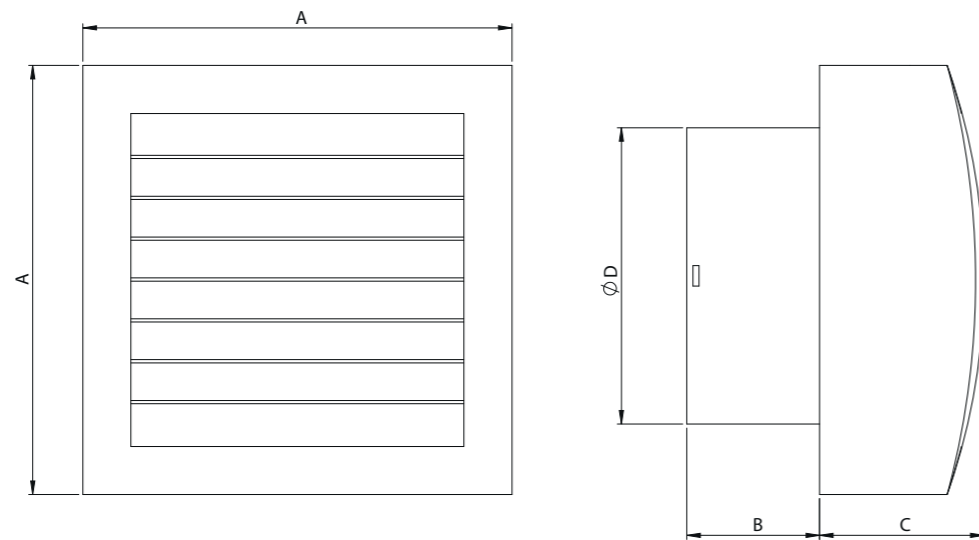

TYPE	A	B	C	D
EC 1010E	150	45	35	97
EC 1219E	170	55	44	118
EC 1530E	210	73	60	149

Dimensions are in (mm)

TYPE	VOLTAGE	FREQUENCY	POWER	CURRENT	CAPACITOR	SPEED	AIR FLOW	SOUND PRESSURE	INSULATION CLASS	PROTECTION CLASS	WEIGHT	PIECES IN BOX
	V	Hz	W	(A)	(μ F)	r.p.m	m ³ /h	dB(A)	Ins.cl.	IP	kg	AD
EC 1010E	230	50/60	15	0,09	-	2600	100	40	B	20	0,6	24
EC 1219E	230	50/60	16	0,09	-	2400	200	41	B	20	0,65	20
EC 1530E	230	50/60	23	0,14	-	2000	300	43	B	20	0,84	16

Sound Level Measured from 3m distance in room condition.

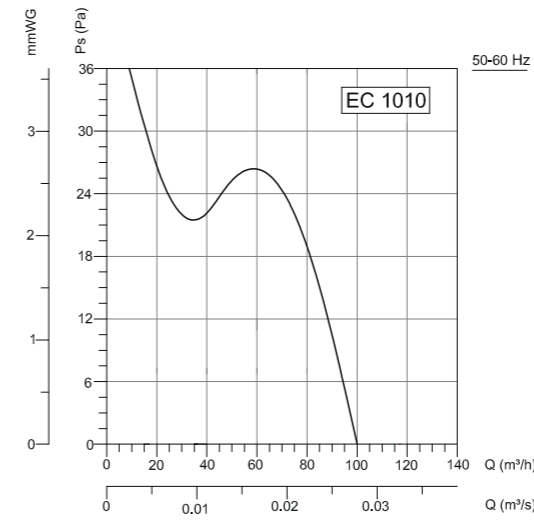

Frequency	Tot	63	125	250	500	1000	2000	4000	8000	Hz
L _{wa} Inlet	47	11	35	40	43	41	37	35	28	dB(A)
L _{wa} Outlet	57	34	48	52	53	43	39	35	25	dB(A)

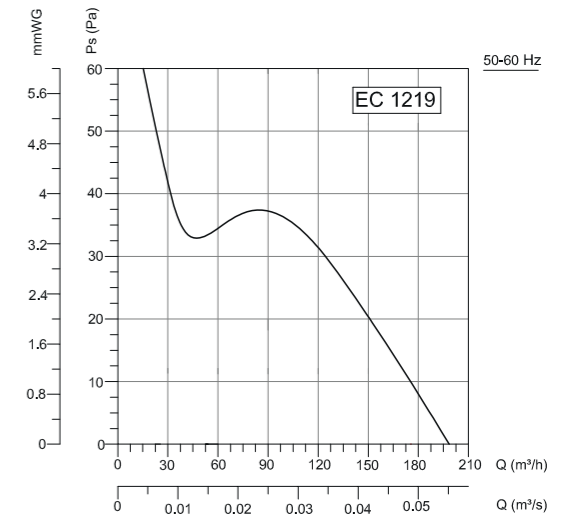

Frequency	Tot	63	125	250	500	1000	2000	4000	8000	Hz
L _{wa} Inlet	48	14	40	42	43	41	39	30	23	dB(A)
L _{wa} Outlet	59	56	51	52	49	42	41	30	25	dB(A)

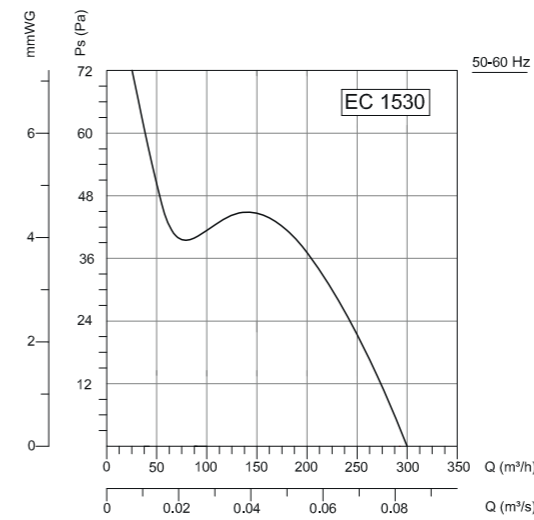

Frequency	Tot	63	125	250	500	1000	2000	4000	8000	Hz
L _{wa} Inlet	50	20	38	44	46	44	39	33	25	dB(A)
L _{wa} Outlet	57	33	50	55	48	41	41	34	20	dB(A)

Accessories



BSC





EA

AXIAL BATHROOM FANS / Standard

It is safe with front louvre design. The panel is wider and tighter. This feature provides a robust mounting design. It is silent and corrosion resistant. Long life of the motor against environmental factors. Thermal protection.

Can be mounted on glass and wall. It is used for small volume spaces, bath and toilet ventilation.

Technical Drawing and Tables

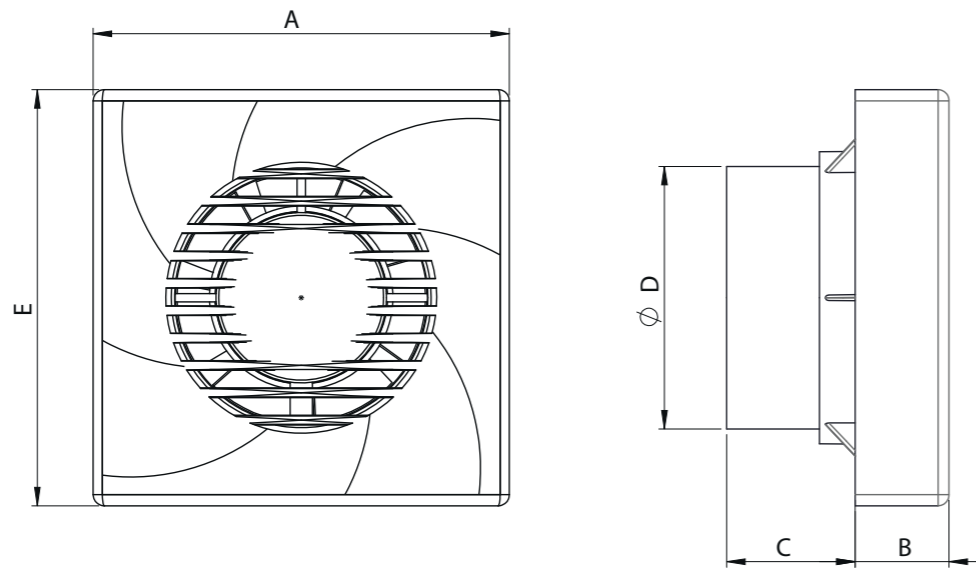

TYPE	A	B	C	D	E
EA 1010	149	32	59	97	149
EA 1219	170	32	59	118	170
EA 1530	200	38	59	145	200

Dimensions are in (mm)

TYPE	VOLTAGE	FREQUENCY	POWER	CURRENT	CAPACITOR	SPEED	AIR FLOW	SOUND PRESSURE	INSULATION CLASS	PROTECTION CLASS	WEIGHT	PIECES IN BOX
	V	Hz	W	(A)	(μ F)	r.p.m	m ³ /h	dB(A)	Ins.cl.	IP	kg	AD
EA 1010	230	50/60	13	0,09	-	2600	100	40	B	20	0,52	24
EA 1219	230	50/60	14	0,09	-	2400	200	41	B	20	0,6	20
EA 1530	230	50/60	21	0,13	-	2000	300	43	B	20	1,12	16

Sound Level Measured from 3m distance in room condition.

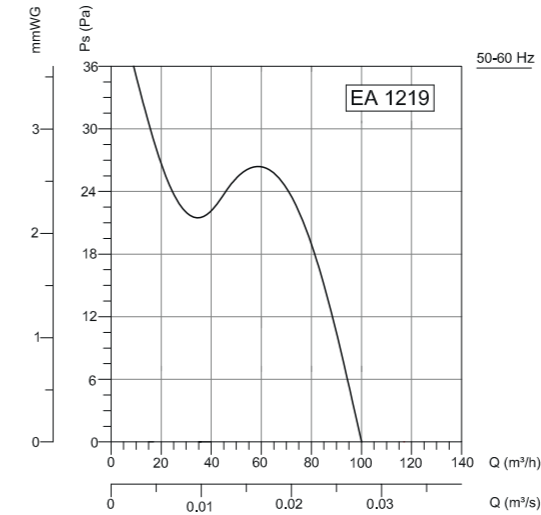

Frequency	Tot	63	125	250	500	1000	2000	4000	8000	Hz
L _{WA} Inlet	47	12	35	41	43	40	36	35	28	dB(A)
L _{WA} Outlet	56	37	49	52	52	42	39	34	26	dB(A)

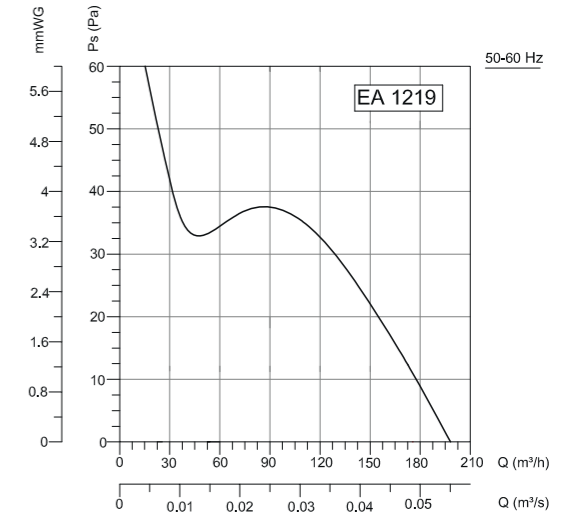

Frequency	Tot	63	125	250	500	1000	2000	4000	8000	Hz
L _{WA} Inlet	48	16	41	42	41	40	38	32	25	dB(A)
L _{WA} Outlet	59	56	52	53	50	43	41	30	23	dB(A)

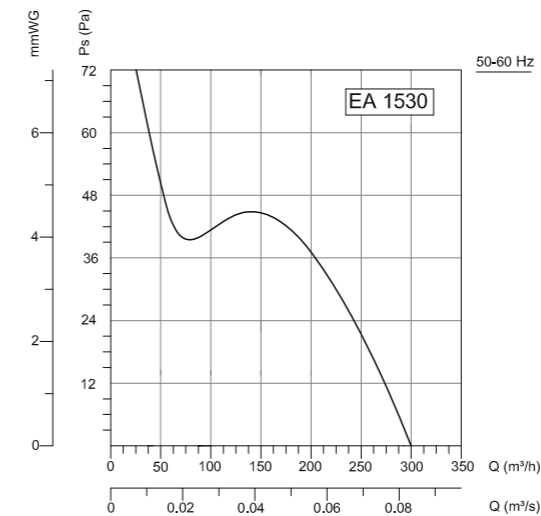

Frequency	Tot	63	125	250	500	1000	2000	4000	8000	Hz
L _{WA} Inlet	50	19	38	44	45	42	40	34	26	dB(A)
L _{WA} Outlet	57	35	49	55	49	42	41	32	21	dB(A)

Accessories



BSC





BPP

AXIAL BATHROOM FANS / Wall Mounted

The front panel is larger and tighter. This feature provides a robust mounting design. It is silent and corrosion resistant. Long life of the motor against environmental factors. It has two-way operation. Meets the need for fresh air for indoor places;

in the other direction, exudes dirty air in the interior. Electrical control structure does not require external control or panel. Used in offices such as offices, meeting rooms, schools, smoking rooms.

Technical Drawing and Tables

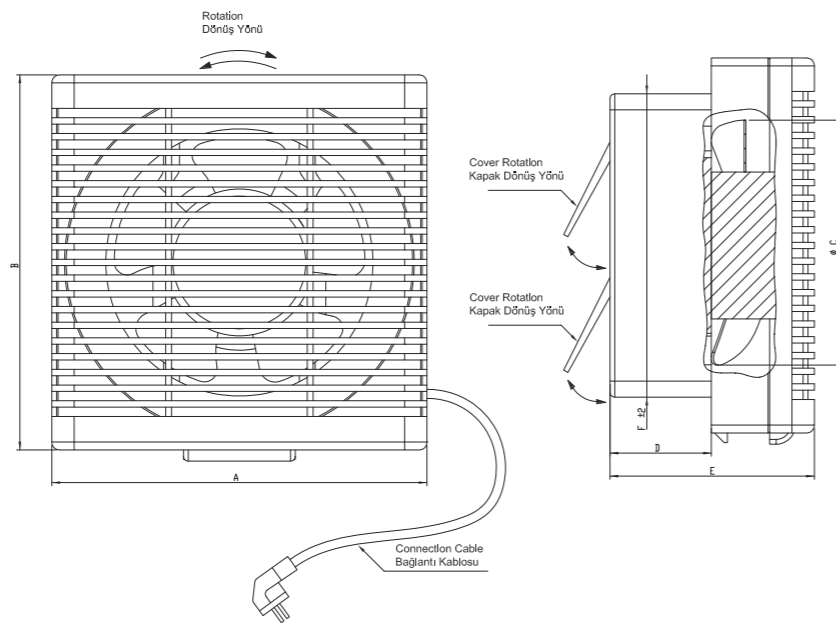

TYPE	A	B	C	D	E	F
BPP 15	235	235	160	65	130	190
BPP 20	290	290	200	65	140	240
BPP 25	340	340	250	70	145	290
BPP 30	395	395	300	80	155	335

Dimensions are in (mm)

TYPE	VOLTAGE	FREQUENCY	POWER	CURRENT	CAPACITOR	SPEED	AIR FLOW	SOUND PRESSURE	INSULATION CLASS	PROTECTION CLASS	WEIGHT	PIECES IN BOX
	V	Hz	W	(A)	(μ F)	r.p.m	m ³ /h	dB(A)	Ins.cl.	IP	kg	AD
BPP 15	230	50/60	25	0,10	-	1350/1620	300/360	40	B	20	1,8	5
BPP 20	230	50/60	30	0,12	-	1250/1450	500/580	41	B	20	2,6	5
BPP 25	230	50/60	35	0,15	-	1250/1375	735/810	43	B	20	2,8	5
BPP 30	230	50/60	40	0,19	-	1100	1100	44	B	20	3,2	5

Sound Level Measured from 3m distance in room condition.

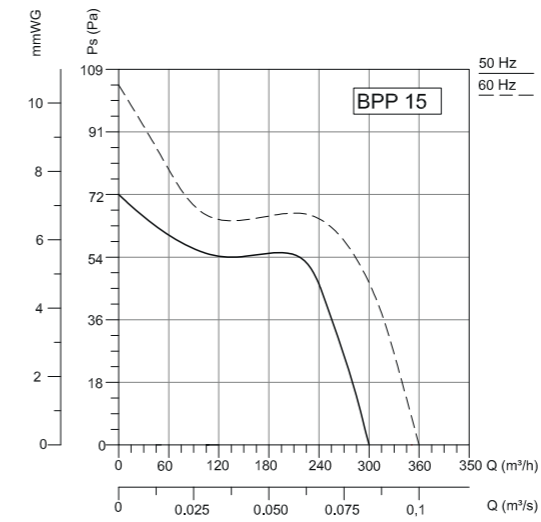

Frequency	Tot	63	125	250	500	1000	2000	4000	8000	Hz
L _{WA} Surrounding	47	24	43	36	41	36	34	31	29	dB(A)

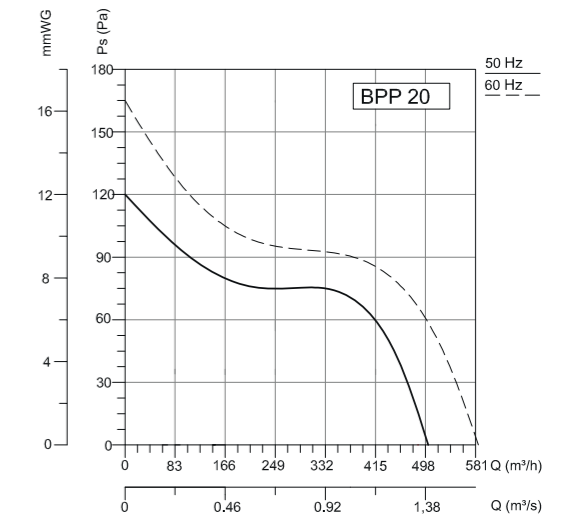

Frequency	Tot	63	125	250	500	1000	2000	4000	8000	Hz
L _{WA} Surrounding	48	25	44	37	42	37	35	32	30	dB(A)

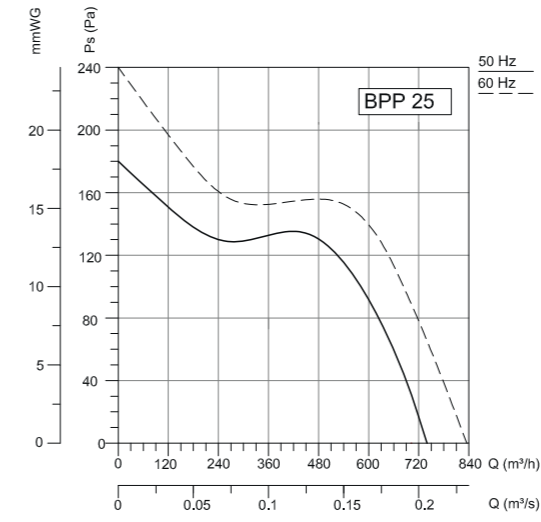

Frequency	Tot	63	125	250	500	1000	2000	4000	8000	Hz
L _{WA} Surrounding	50	25	39	41	47	41	39	34	39	dB(A)

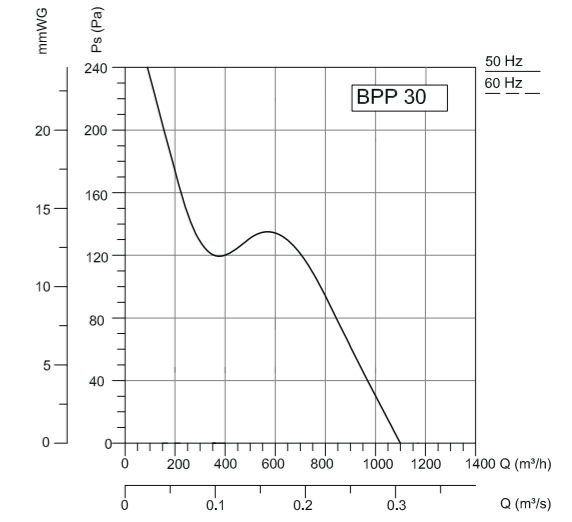

Frequency	Tot	63	125	250	500	1000	2000	4000	8000	Hz
L _{WA} Surrounding	51	23	35	39	49	43	41	35	28	dB(A)

Accessories



BSC



BPR

RADIAL BATHROOM FANS / Standart

BPR series fans have a very stylish look. Manufactured from materials resistant to external influences provided by the bathing environment. It is very easy to install and provides high flow rate and pressure at very low noise levels thanks to optimum motor, fan and body design.

Maintenance-free motor with long-term performance. Flexible channel can be connected with the pressure provided by the radial fan. Mounting on suspended ceilings. It is used for small volume spaces, bath and toilet ventilation.

Technical Drawing and Tables

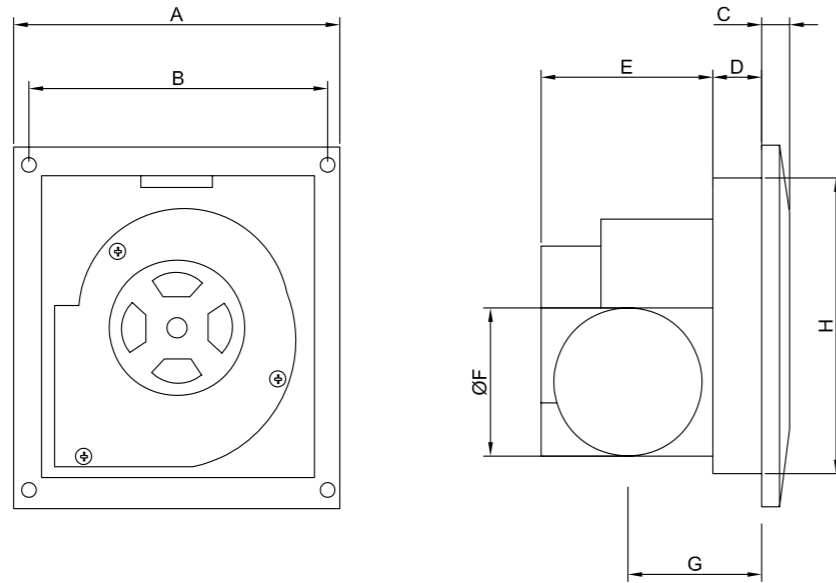

TYPE	A	B	C	D	E	F	G	H
BPR 1012	240	220	20	38	128	100	101	200
BPR 1015	264	240	20	40	128	100	114	224

Dimensions are in (mm)

TYPE	VOLTAGE V	FREQUENCY Hz	POWER W	CURRENT (A)	CAPACITOR (µF)	SPEED r.p.m	AIR FLOW m³/h	SOUND PRESSURE dB(A)	INSULATION CLASS Ins.cl.	PROTECTION CLASS IP	WEIGHT kg	PIECES IN BOX AD
BPR 1012	230	50/60	22	0,9	0,4	1050	120	28	B	20	1,9	6
BPR 1015	230	50/60	28	0,12	0,12	1550	150	32	B	20	2,1	6

Sound Level Measured from 3m distance in room condition.

Accessories



BSC

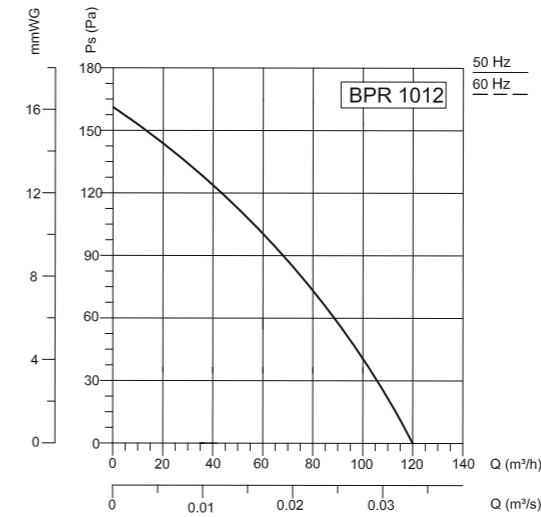

Frequency	Tot	63	125	250	500	1000	2000	4000	8000	Hz
L _{WA} Inlet	35	22	32	29	24	22	20	18	13	dB(A)

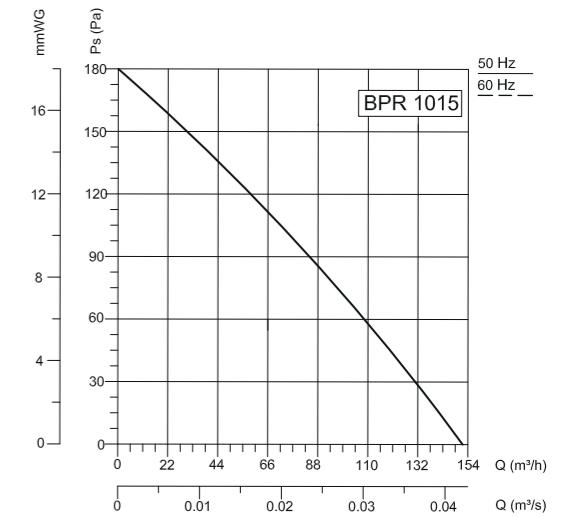

Frequency	Tot	63	125	250	500	1000	2000	4000	8000	Hz
L _{WA} Inlet	39	27	32	31	30	31	29	28	23	dB(A)



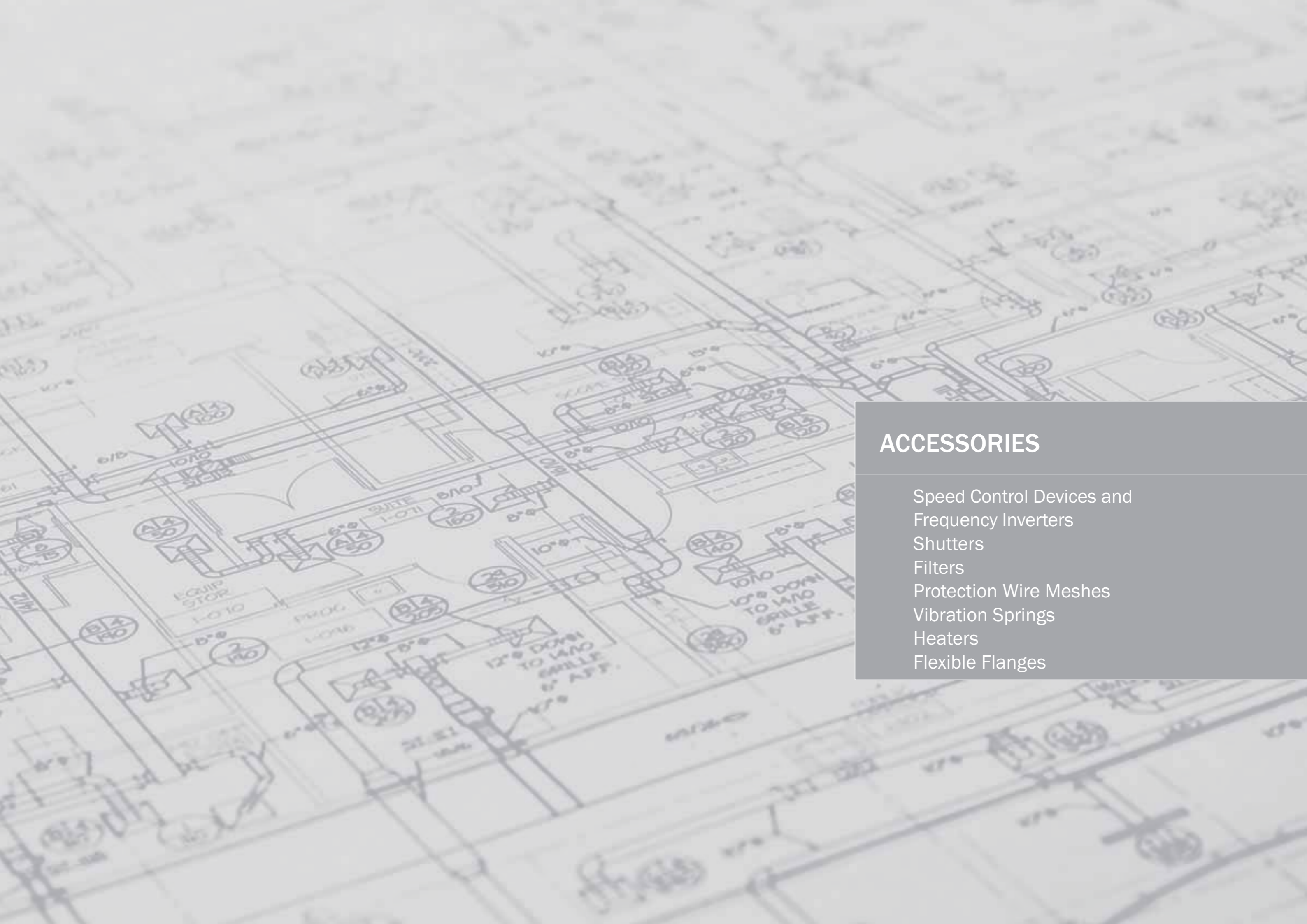

ACCESSORIES

Speed Control Devices and
Frequency Inverters
Shutters
Filters
Protection Wire Meshes
Vibration Springs
Heaters
Flexible Flanges

ACCESSORIES

They are auxiliary elements used in fan assembly, speed adjustment and protection.

DAMPERS

SPEED CONTROLLER AND
FREQUENCY INVERTERS

FILTERS



CONNECTORS



SILENCER



PROTECTION GRILL

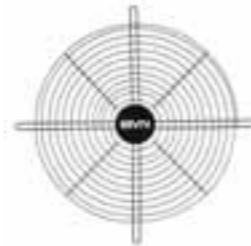

DUCT MATCH FLANGES



HEATER



VIBRATION ISOLATOR





BSC

SPEED CONTROL DEVICES

BSC provides operation in minimum and maximum voltage range, it is used for speed control of fans for ventilation purposes. It is used for speed control of 2-phase (single-phase) fans.

Allows control of fan flow with speed control. BSC-DS is used in double speed fans to control speed in both cycles.

TYPE	VOLTAGE		AMPERE
	V	A	
BSC-1	230		2
BSC-2	230		5
BSC-3	230		10
BSC-DS	230		5

Sound Level Measured from 3m distance in room condition.



BSC-F

FREQUENCY INVERTERS

3-phase alternating current is a modern speed control device that works with the IPM-SPWM technique, which can adjust the speed of the motor from zero to the desired value with high starting torque.

It is used in 3 phase motor operated fans. By adjusting the motor speed, it helps to bring the fan flow rate to the desired value.

TYPE	VOLTAGE		MOTOR POWER
	INPUT/V	OUTPUT/V	
BSC-F-10	230	380	0,75
BSC-F-15	230	380	1,5
BSC-F-22	230	380	2,2
BSC-F-30	380	380	3
BSC-F-40	380	380	4
BSC-F-55	380	380	5,5
BSC-F-75	380	380	7,5
BSC-F-110	380	380	11
BSC-F-150	380	380	15
BSC-F-180	380	380	18,5
BSC-F-220	380	380	22
BSC-F-300	380	380	30

Sound Level Measured from 3m distance in room condition.



BYH

CIRCULAR AIR SHUTTERS

Made of galvanized sheet metal, controlled by air flow allows reception. Manual and automatic type.

TYPE	øa	B
BYH 160	160	210
BYH 180	180	230
BYH 200	203	250
BYH 225	229	275
BYH 250	254	300
BYH 280	280	330
BYH 300	305	350
BYH 350	356	400
BYH 400	406	450

Dimensions are in (mm)

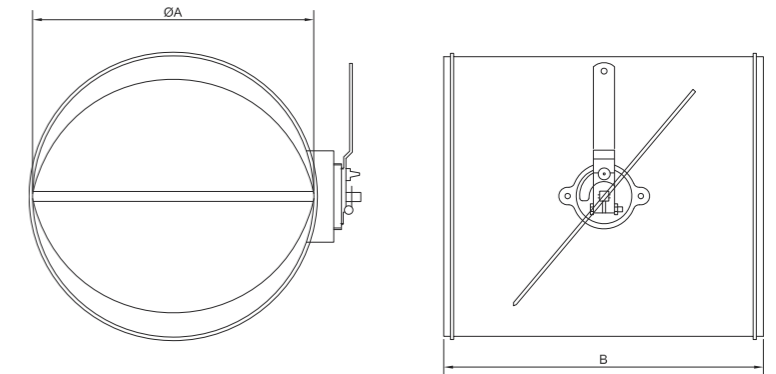

BDH

RECTANGULAR AIR SHUTTERS

Manufactured with aluminum extrusion method. Ensures control of air flow.

It is manufactured in two types with manual and automatic movement capability.

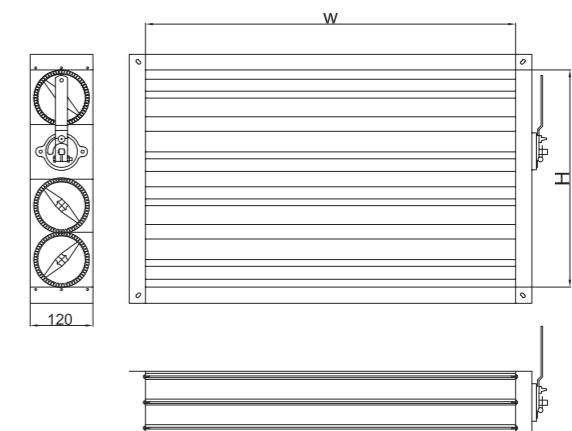



BBDD

BACK DRAFT DAMPERS

It provides a directional air flow in the air ducts. Use for pressurization suitable. At the same time suction or automatic opening.

TYPE	DIMENSIONS	
	H	W
BBDD 400	450	450
BBDD 450	500	500
BBDD 500	550	550
BBDD 560	600	600
BBDD 630	700	700
BBDD 710	800	800
BBDD 800	850	850
BBDD 900	950	950
BBDD 1000	1050	1050
BBDD 1250	1300	1300

Dimensions are in (mm)

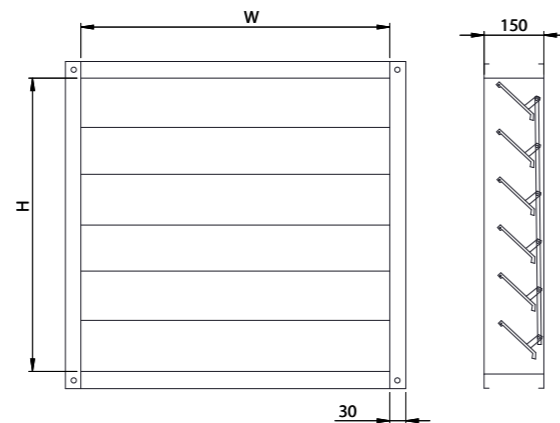

BASP

ROUND METAL AIR SHUTTERS / Ø160 - Ø800

It is manufactured from galvanized sheet and opened in the direction of air flow. Prevents air from entering the system when air flow is interrupted. When the fan is not working, it prevents the unwanted air, foreign body, dust entrance into the interior.

TYPE	A	B
BASP 160	160	83
BASP 200	200	83
BASP 250	265	83
BASP 300	315	83
BASP 350	365	83
BASP 400	415	83
BASP 450	465	83
BASP 500	520	83
BASP 600	620	83
BASP 700	725	83
BASP 800	830	83

Dimensions are in (mm)

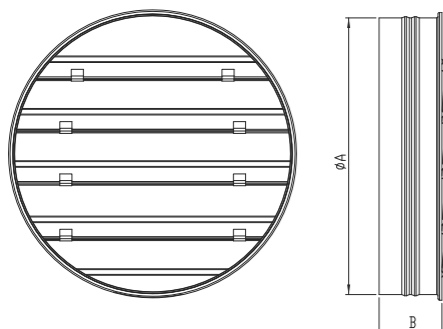

BYF

OIL FILTER

In case BDTX series products are used in oily and extremely dirty environments, BYF oil trap filters must be used. These filters retain the oil and particles that can damage the motor due to their oil-retaining properties, thereby adhering to the propeller and aggravating it and preventing it from balancing over time. The BYF filters are designed to be easily installed in the duct. In case BDTX fans are used in oily and dirty environments, BYF filter extends service life.

TYPE	A	B	C	D	E
BYF 200	135	195	270	335	20
BYF 250	130	245	270	335	20
BYF 315	165	290	280	345	20

Dimensions are in (mm)

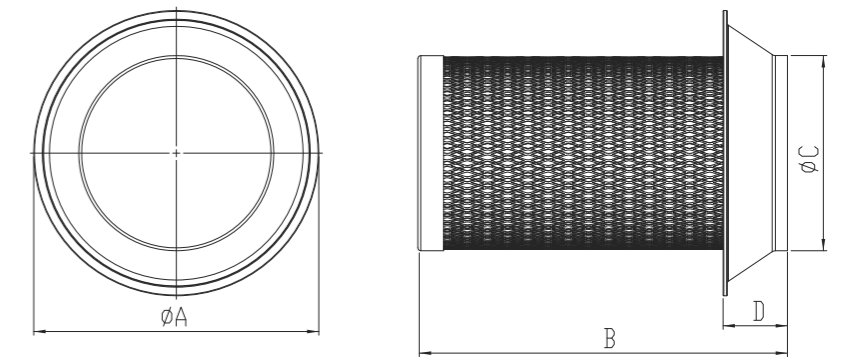

BFG2

METALLIC FILTER

Washable metal filters for high oil and dust holding capacity. They can also work in extremely humid environments and high temperatures. - Air filtration in corrosive environments; - For grease and sparks, for separating oil vapors They are used.

TYPE	DIMENSIONS		FILTER SURFACE m ²	AIR FLOW m ³ /h	PRESSURE (Pa)
	A	B			
BFG2-1	278	287	0,14	1040	60
BFG2-2	287	592	0,29	2120	60
BFG2-3	592	592	0,60	4360	60

Dimensions are in (mm). Sound Level Measured from 3m distance in room condition.

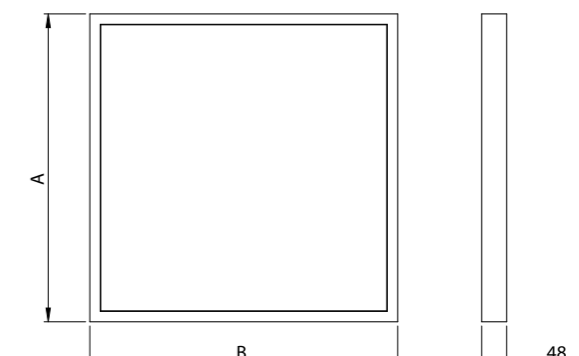



BFG3

ACTIVE CARBON FILTER

Fiber filters impregnated with activated carbon powder;
 - Absorption of gases and gaseous substances
 - In the interior of air purification
 - They are used in chimney type shelter devices.

TYPE	DIMENSIONS		FILTER SURFACE m ²	AIR FLOW m ³ /h	PRESSURE (Pa)
	A	B			
BFG3-1	278	287	0,18	710	65
BFG3-2	287	592	0,37	1500	65
BFG3-3	592	592	0,75	3000	65

Dimensions are in (mm). Sound Level Measured from 3m distance in room condition.

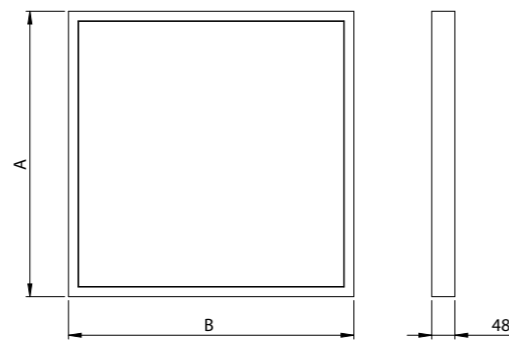

BFG4

CASSETTE FILTER

As a pre-filter in all types of ventilation and air conditioning systems. It is used.

TYPE	DIMENSIONS		FILTER SURFACE m ²	AIR FLOW m ³ /h	PRESSURE (Pa)
	A	B			
BFG4-1	287	287	0,14	761	80
BFG4-2	287	592	0,29	1570	80
BFG4-3	592	592	0,60	3240	80
BFG4-4	180	287	0,09	478	80
BFG4-5	180	400	0,13	666	80
BFG4-6	264	365	0,17	890	80
BFG4-7	314	505	0,27	1466	80
BFG4-8	365	650	0,32	1704	80
BFG4-9	382	592	0,39	2090	80
BFG4-10	425	650	0,47	2555	80
BFG4-11	465	650	0,52	2800	80
BFG4-12	565	650	0,63	3400	80

Dimensions are in (mm). Sound Level Measured from 3m distance in room condition.

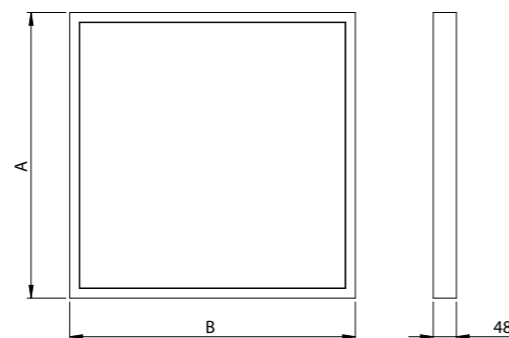

BFH13

HEPA FILTER

High sterilized air treatment systems, clinics, laboratories and They are used in necessary places such as hospitals.
 Note: All Filters have their own unique test certificates.

TYPE	DIMENSIONS		AIR FLOW m ³ /h	PRESSURE (Pa)
	A	B		
BFH13-1	305	305	1000	250
BFH13-2	305	610	2000	250
BFH13-3	610	610	4000	250

Dimensions are in (mm). Sound Level Measured from 3m distance in room condition.

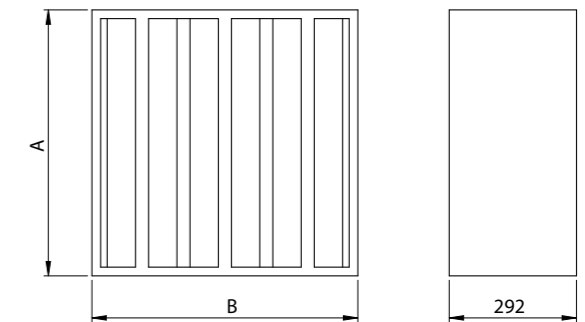

BSST

CIRCULAR DUCT TYPE SILENCERS

Sound level during air transfer in mufflers axial fans values are used to minimize.

TYPE	DIMENSIONS					WEIGHT kg
	ØDi	ØTk	ØDa	ZxØd	L	
BSST 400	400	450	500	8XM10	400	13,4
BSST 450	450	500	550	8XM10	450	16,0
BSST 500	500	560	600	12XM10	500	18,8
BSST 560	560	620	720	12XM10	560	26,5
BSST 630	630	690	790	12XM10	630	31,6
BSST 710	710	770	870	16XM10	710	38,7
BSST 800	800	860	1000	16XM10	800	63,2
BSST 900	900	970	1100	16XM12	900	76,4
BSST 1000	1000	1070	1200	16XM12	1000	91,3
BSST 1250	1250	1320	1450	20XM12	1250	131,2

Dimensions are in (mm). Sound Level Measured from 3m distance in room condition.

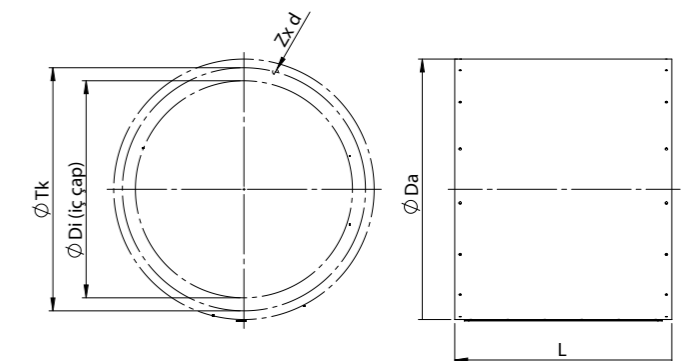



BYKS

CIRCULAR DUCT TYPE SILENCERS

Effectively reduces the volume of cylindrical duct-type fans. Sound shower values are designed according to the desired capacities. Insulation thickness is 50mm.

TYPE	DIMENSIONS				SOUND FALL VALUE dB(A)						
	Lnom	ød1	ød0	L	125	250	500	1k	2k	4k	8k
BYKS 100	900	100	200	960	4	15	34	50	50	48	23
BYKS 125	900	125	224	965	4	12	33	45	50	30	17
BYKS 150	900	150	250	965	4	10	28	42	43	20	15
BYKS 160	900	160	260	970	4	10	28	40	41	20	14
BYKS 200	900	200	300	985	4	8	24	32	34	13	10
BYKS 250	900	250	355	900	4	8	20	26	23	10	8
BYKS 315	900	315	415	900	3	7	16	22	12	6	7
BYKS 355	900	355	560	900	3	5	10	13	7	5	6

Dimensions are in (mm). Sound Level Measured from 3m distance in room condition.

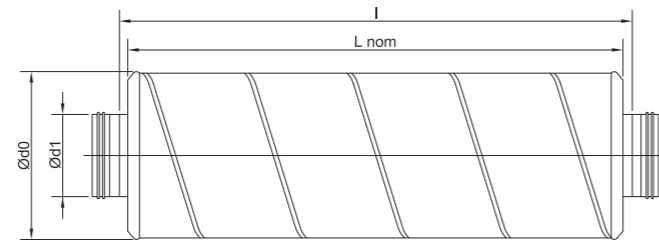

BDKS

RECTANGULAR DUCT TYPE SILENCERS

Effectively reduces the volume of the duct-type fans. Sound shower values are designed according to the desired capacities.

TYPE	DIMENSIONS		SOUND FALL VALUE dB(A)						
	B	H	125	250	500	1k	2k	4k	8k
BDKS 30-15	300	150	7	15	18	25	25	19	19
BDKS 40-20	400	200	5	9	15	23	16	12	10
BDKS 50-25	500	250	10	15	25	25	20	15	12
BDKS 50-30	500	300	8	15	20	31	17	14	11
BDKS 60-30	600	300	8	15	20	31	17	14	11
BDKS 60-35	600	350	7	13	17	18	13	10	8
BDKS 70-40	700	400	7	11	14	14	10	8	6
BDKS 80-50	800	500	6	8	10	11	8	6	3
BDKS 100-50	1000	500	6	8	10	11	8	6	3

Dimensions are in (mm). Sound Level Measured from 3m distance in room condition.

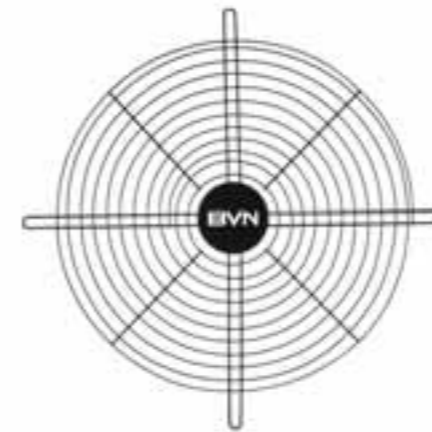
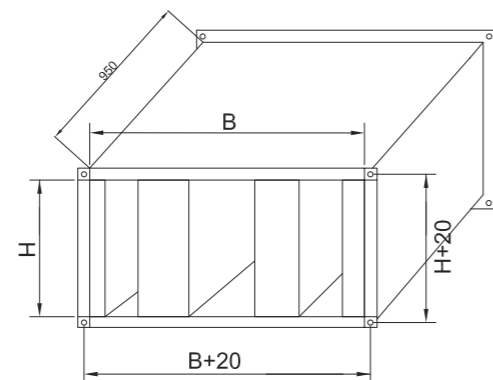

BTEK

GRILL

Wire cages used in our axial fans; with suction vacuum to prevent foreign bodies from entering the propeller and motor part. It is used.

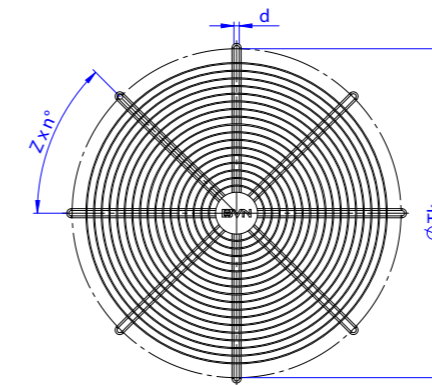

TYPE	DIMENSIONS			WEIGHT kg
	øTk	Zxn0	d	
BTEK 400	450	4X90	12	0,7
BTEK 450	500	4X90	12	0,8
BTEK 500	560	4X90	12	0,9
BTEK 560	620	4X90	12	1,0
BTEK 630	690	4X90	12	1,13
BTEK 710	770	8X45	14	2,0
BTEK 800	860	8X45	14	2,4
BTEK 900	970	8X45	14	3,4
BTEK 1000	1070	8X45	14	3,9
BTEK 1250	1320	10X36	14	5,9

Dimensions are in (mm). Sound Level Measured from 3m distance in room condition.



BTY

VIBRATION SPRINGS

It is used as a vibration dampener in our products. to be used We have different wire diameters according to their weights.

TYPE	DIMENSIONS			WEIGHT kg
	D	H	M	
BTY 01	55	76	M10	25mm/22kg
BTY 02	55	76	M10	25mm/34kg
BTY 03	55	76	M10	25mm/51kg
BTY 04	55	76	M10	25mm/100kg
BTY 05	55	76	M10	25mm/137kg
BTY 06	55	76	M10	25mm/200kg

Dimensions are in (mm). Sound Level Measured from 3m distance in room condition.

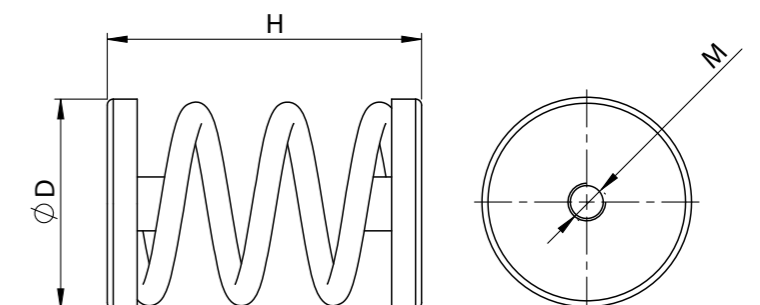



BCTH

DUCT TYPE HEATING

Body material of channel type heaters are galvanized sheet or stainless steel sheet. Heating elements of the heaters produced as 304 stainless steel pipe as produced.

General applications are ventilation systems. Different channel types and these devices are produced according to the dimensions of the

preheater to heat the outside air, they are used as main or final heaters for heating air or blowing air. Easy to channel, especially when aqueous system heaters are unavailable they are quite useful devices with mounting possibilities.

* 70 110C and 110 70C (manual reset) safety standard for all heaters thermostat.

TYPE	VOLTAGE	POWER
	V	kW
BCTH 75	380	3
BCTH 100	380	3
BCTH 200	380	5
BCTH 300	380	8
BCTH 400	380	10
BCTH 500	380	13

Sound Level Measured from 3m distance in room condition.

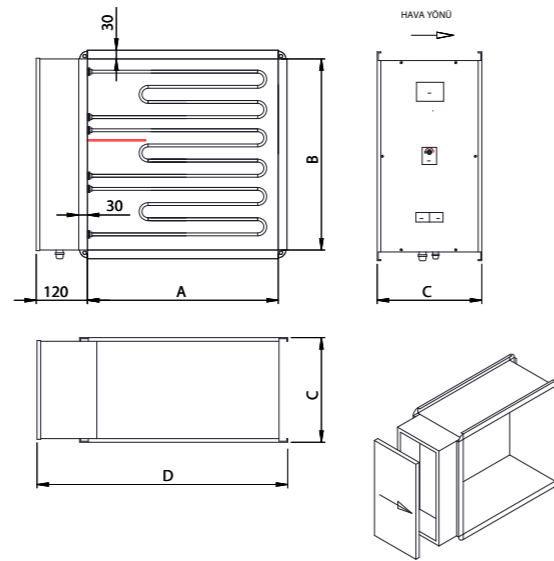

BESB

CIRCULAR FLEXIBLE FLANGES

Depending airstream that occur at axial fans flexibility while fan assembly. don't transmit the natural vibration. It is provide

TYPE	DIMENSIONS		WEIGHT
	ØDi	L	kg
BESB 400	404	130	0,58
BESB 450	454	130	0,65
BESB 500	504	130	0,73
BESB 560	564	130	0,81
BESB 630	634	130	0,91
BESB 710	714	130	1,03
BESB 800	804	130	1,15
BESB 900	904	130	1,30
BESB 1000	1004	130	1,44
BESB 1250	1254	130	1,80

Dimensions are in (mm). Sound Level Measured from 3m distance in room condition.

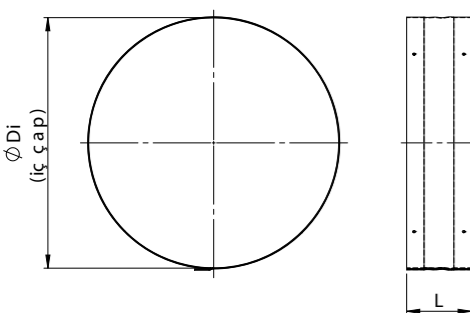

BDEB

RECTANGULAR FLEXIBLE FLANGES

It is made of aluminum profile and canvas.

TYPE	A	B
BDEB 30-15	300	150
BDEB 40-20	400	200
BDEB 50-25	500	250
BDEB 50-30	500	300
BDEB 60-30	600	300
BDEB 60-35	600	350
BDEB 70-40	700	400
BDEB 80-50	800	500
BDEB 100-50	1000	500

Dimensions are in (mm)

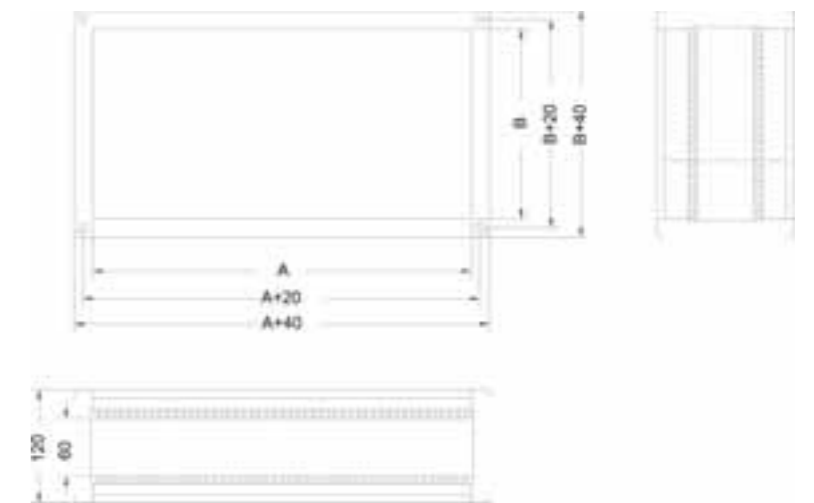

BKFB

COUNTER FLANGE

They are used to connect axial fans to the duct system.

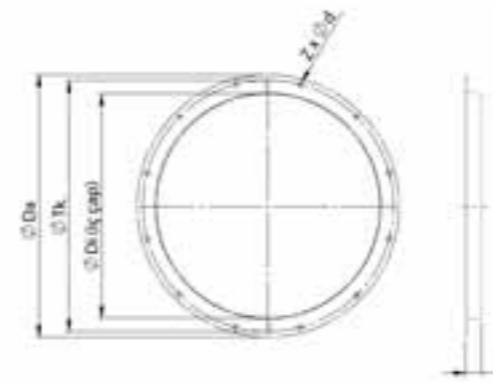

TYPE	DIMENSIONS					WEIGHT
	ØDi	ØTk	ØDa	ZxØd	L	kg
BSST 400	400	450	475	8X12	35	2,0
BSST 450	450	500	525	8X12	35	2,1
BSST 500	500	560	585	12X12	35	2,4
BSST 560	560	620	650	12X12	40	2,8
BSST 630	630	690	720	12X12	40	3,1
BSST 710	710	770	800	16X12	45	3,6
BSST 800	800	860	890	16X12	45	4,0
BSST 900	900	970	1000	16X14	45	5,7
BSST 1000	1000	1070	1100	16X14	50	6,6
BSST 1250	1250	1320	1360	20X14	50	8,5

Dimensions are in (mm). Sound Level Measured from 3m distance in room condition.

