

## NIMAX ATEX (2G)

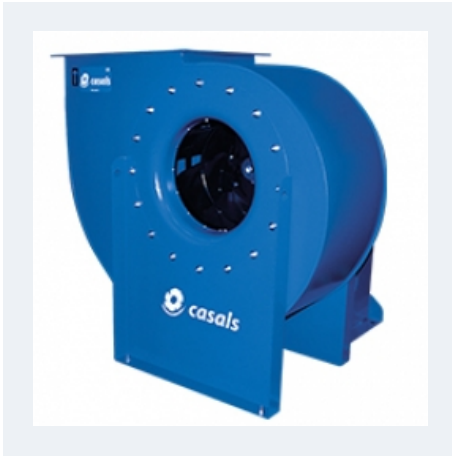

### **CENTRIFUGAL FAN WITH BACKWARD IMPELLER, DIRECT DRIVEN WITH FEET MOTOR (B3) ATEX.**

#### MANUFACTURING FEATURES

- Medium pressure centrifugal fan with direct coupling.
- Reinforced housing made of carbon laminated steel, protected against corrosion by powder coating polyester resin RAL 5010. Finish C3.
- Casing fully latched and adjustable.
- Self-cleaning turbine and reinforced impeller with high-performance backward (reaction) blades made of carbon laminated steel dynamically balanced to minimize noise and vibrations. Black painted RAL 9005
- Squirrel cage standardized asynchronous IEC motor with IP-55 protection and class F electrical insulation. Standard voltages 230/400V 50Hz for three-phase motors up to 4kW and 400/690V 50Hz for higher powers.
- Motor with feet (B3) supported on motor support foot.
- Models of size 500 and above are supplied with a front support foot, for the other models the front support foot is optional.
- Available in the following orientations (to be indicated in case of order): LG0, LG45, LG90, LG135, LG180; LG225, LG270, LG315, RD0, RD45, RD90, RD135, RD180; RD225, RD270, RD315.
- Maximum working temperature in continuous: air transported: 130°C, Environment: 60°C.

• Available in the following versions (to be indicated in case of order):

- ATEX II2G Ex\_d
- ATEX II2G Ex\_e
- ATEX II3GD Ex\_na (see NIMAX ATEX (3G))

#### APPLICATIONS

Suitable for moving clean or dusty air. Designed to be installed in conduit for suction or impulsion.

- Paint booths
- Collection of dust
- Food industry dryers
- Food processing
- Incineration
- Odor control in industry
- Indoor / outdoor pollution control
- Big buildings
- Malls
- Factories / Industrial buildings
- Warehouses
- Extraction of smoke
- Boilers and ovens
- Manufacture and treatment of chemical products.
- Tunnels, underground stations.

#### ON DEMAND

- Fans for 60Hz and special voltages.
- 2 speed motor.

- C4 or C5 coating painting
- Hot dip galvanized
- Inox 304 (normal or electropolished finish)
- Inox 316 (normal or electropolished finish)
- Cooling wheel
- Anticaloric paint
- Fully welded housing (waterproof)
- Inspection door to facilitate maintenance and cleaning
- Drain plug.
- Airtight axle
- Other brands of motors.

## Technical data

### Three-phase motor / 2 poles

Code	Model	R.P.M.	Rated I. (A) 400V	Rated power kW	Max. Airflow m3/h	Sound db (A)**	Weight	Connect. diagram
NX313290X_	NIMAX 313 T2 1,5kW ATEX (2G)	2865	3,95	1,50	5.240	60	36,94	1
NX314290X_	NIMAX 314 T2 1,5kW ATEX (2G)	2865	3,95	1,50	5.500	60	36,89	1
NX353290X_	NIMAX 353 T2 2,2kW ATEX (2G)	2840	5,4	2,20	7.500	63	45,95	1
NX3542100X_	NIMAX 354 T2 3kW ATEX (2G)	2880	7,3	3	7.870	64	50,47	1
NX4032112X_	NIMAX 403 T2 4kW ATEX (2G)	2880	9,2	4	10.730	67	63,55	1
NX4042132X_	NIMAX 404 T2 5,5kW ATEX (2G)	2910	11,46	5,50	11.260	67	75,16	1
NX4532132X_	NIMAX 453 T2 7,5kW ATEX (2G)	2910	14,1	7,50	15.280	70	89,90	1
NX4542132X_	NIMAX 454 T2 9,2kW ATEX (2G)	2930	16,60	9,20	16.040	71	90,43	1
NX5032160X_	NIMAX 503 T2 15kW ATEX (2G)	2935	27,4	15	20.960	74	115,15	1
NX5042160X_	NIMAX 504 T2 15kW ATEX (2G)	2935	27,4	15	22.000	74	116,85	1

### Three-phase motor / 4 poles

Code	Model	R.P.M.	Rated I. (A) 400V	Rated power kW	Max. Airflow m3/h	Sound db (A)**	Weight	Connect. diagram
NX313471X_	NIMAX 313 T4 0,37kW ATEX (2G)	1400	1,2	0,37	2.620	45	35,81	1
NX314471X_	NIMAX 314 T4 0,37kW ATEX (2G)	1400	1,2	0,37	2.750	45	36,04	1
NX353471X_	NIMAX 353 T4 0,37kW ATEX (2G)	1400	1,2	0,37	3.750	48	44,79	1
NX354471X_	NIMAX 354 T4 0,37kW ATEX (2G)	1400	1,2	0,37	3.940	49	45,26	1
NX403480X_	NIMAX 403 T4 0,55kW ATEX (2G)	1400	1,75	0,55	5.370	52	57,48	1
NX404480X_	NIMAX 404 T4 0,55kW ATEX (2G)	1400	1,75	0,55	5.630	52	57,89	1
NX453490X_	NIMAX 453 T4 1,1kW ATEX (2G)	1450	3,3	1,10	7.640	55	72,26	1
NX454490X_	NIMAX 454 T4 1,1kW ATEX (2G)	1450	3,3	1,10	8.020	56	72,87	1
NX503490X_	NIMAX 503 T4 1,5kW ATEX (2G)	1440	3,8	1,50	10.480	59	90,45	1
NX5044100X_	NIMAX 504 T4 2,2kW ATEX (2G)	1435	5,8	2,20	11.000	59	97,23	1
NX5634100X_	NIMAX 563 T4 3kW ATEX (2G)	1420	6,8	3	14.730	62	125,23	1
NX5644100X_	NIMAX 564 T4 3kW ATEX (2G)	1420	6,8	3	15.460	63	126,18	1
NX6334132X_	NIMAX 633 T4 5,5kW ATEX (2G)	1460	11,5	5,50	20.970	66	166,71	1
NX6344132X_	NIMAX 634 T4 5,5kW ATEX (2G)	1460	11,5	5,50	22.010	66	170,69	1
NX7134132X_	NIMAX 713 T4 9,2kW ATEX (2G)	1465	17,40	9,20	30.010	69	212,46	1
NX7144160X_	NIMAX 714 T4 11kW ATEX (2G)	1455	20,9	11	31.500	70	222,65	1
NX8034180X_	NIMAX 803 T4 18,5kW ATEX (2G)	1470	35,6	18,50	42.930	73	277,93	1
NX8044180X_	NIMAX 804 T4 18,5kW ATEX (2G)	1470	35,6	18,50	45.060	73	279,93	1
NX9034200X_	NIMAX 903 T4 30kW ATEX (2G)	1475	56,3	30	61.130	76	379,05	1
NX9044225X_	NIMAX 904 T4 37kW ATEX (2G)	1470	69,2	37	64.160	77	382,71	1

Code	Model	R.P.M.	Rated I. (A) 400V	Rated power kW	Max. Airflow m3/h	Sound db (A)**	Weight	Connect. diagram
NX10034250X_	NIMAX 1003 T4 55kW ATEX (2G)	1475	97,1	55	83.850	80	462,52	1
NX10044250X_	NIMAX 1004 T4 55kW ATEX (2G)	1475	97,1	55	88.010	80	464,82	1

### Three-phase motor / 6 poles

Code	Model	R.P.M.	Rated I. (A) 400V	Rated power kW	Max. Airflow m3/h	Sound db (A)**	Weight	Connect. diagram
NX503680X_	NIMAX 503 T6 0,55kW ATEX (2G)	900	2	0,55	6.990	50	89,92	1
NX504680X_	NIMAX 504 T6 0,55kW ATEX (2G)	900	2	0,55	7.330	50	90,72	1
NX563690X_	NIMAX 563 T6 1,1kW ATEX (2G)	925	3,2	1,10	9.820	53	118,71	1
NX564690X_	NIMAX 564 T6 1,1kW ATEX (2G)	925	3,2	1,10	10.300	54	119,71	1
NX6336100X_	NIMAX 633 T6 1,5kW ATEX (2G)	940	4	1,50	13.980	57	154,50	1
NX6346112X_	NIMAX 634 T6 2,2kW ATEX (2G)	965	5,2	2,20	14.670	57	156,23	1
NX7136132X_	NIMAX 713 T6 3kW ATEX (2G)	960	7,8	3	20.010	60	208,16	1
NX7146132X_	NIMAX 714 T6 3kW ATEX (2G)	960	7,8	3	21.000	61	209,71	1
NX8036132X_	NIMAX 803 T6 5,5kW ATEX (2G)	960	12,8	5,50	28.620	64	260,36	1
NX8046132X_	NIMAX 804 T6 5,5kW ATEX (2G)	960	12,8	5,50	30.040	65	262,16	1
NX9036160X_	NIMAX 903 T6 11kW ATEX (2G)	975	-	15	40.750	68	339,60	1
NX9046160X_	NIMAX 904 T6 11kW ATEX (2G)	965	22,6	11	42.770	68	342,35	1
NX10036180X_	NIMAX 1003 T6 15kW ATEX (2G)	970	27,7	15	55.900	71	411,83	1
NX10046200X_	NIMAX 1004 T6 18,5kW ATEX (2G)	975	35,7	18,50	58.670	71	450,85	1

### Three-phase motor / 8 poles

Code	Model	R.P.M.	Rated I. (A) 400V	Rated power kW	Max. Airflow m3/h	Sound db (A)**	Weight	Connect. diagram
NX8038132X_	NIMAX 803 T8 2,2kW ATEX (2G)	700	5,44	2,20	21.470	57	260,36	1
NX8048132X_	NIMAX 804 T8 2,2kW ATEX (2G)	700	5,44	2,20	22.530	58	262,16	1
NX9038160X_	NIMAX 903 T8 4kW ATEX (2G)	725	9,43	4	30.560	61	333,55	1
NX9048160X_	NIMAX 904 T8 4kW ATEX (2G)	725	9,43	4	32.080	61	336,35	1
NX10038160X_	NIMAX 1003 T8 7,5kW ATEX (2G)	725	17	7,50	41.930	64	406,15	1
NX10048160X_	NIMAX 1004 T8 7,5kW ATEX (2G)	725	17	7,50	44.000	65	409,35	1

**Notes:**

\*\* Total sound pressure level at the point of maximum flow measured in dB(A) in the suction measured in free field at a distance of 6m from the source

## Dimensions

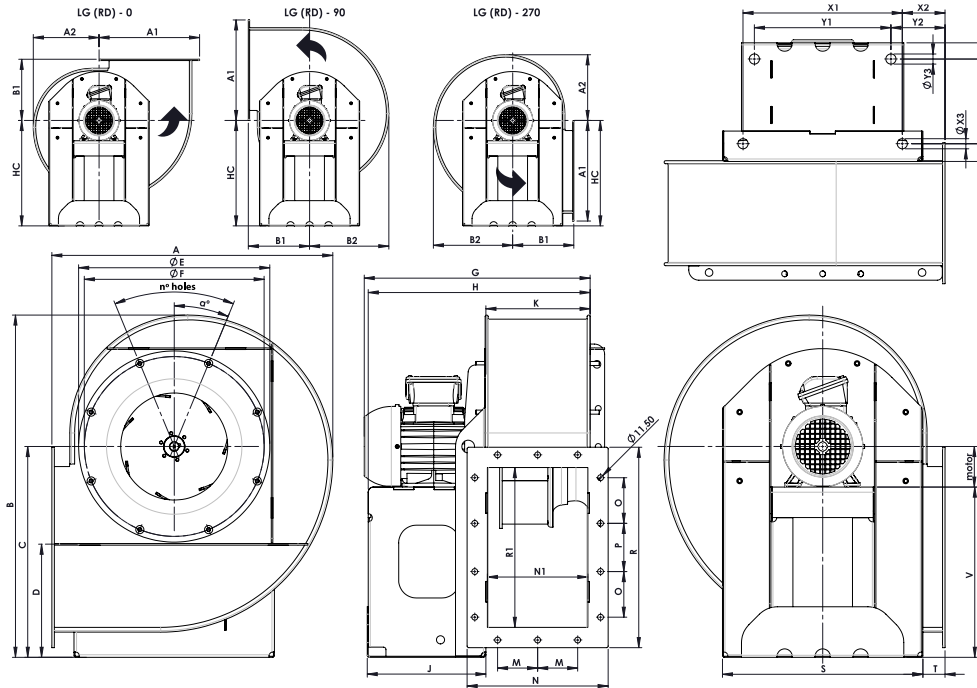

Model	A	A1	A2	B	B1	B2	C	D	E
NIMAX 313 T2 1,5kW ATEX (2G)	554	396.5	259.2	675	241.3	312.6	415.5	216.5	377
NIMAX 313 T4 0,37kW ATEX (2G)	554	396.5	259.2	675	241.3	312.6	415.5	216.5	377
NIMAX 314 T2 1,5kW ATEX (2G)	554	396.5	259.2	675	241.3	312.6	415.5	216.5	377
NIMAX 314 T4 0,37kW ATEX (2G)	554	396.5	259.2	675	241.3	312.6	415.5	216.5	377
NIMAX 353 T2 2,2kW ATEX (2G)	617	441.8	290.9	751.5	266.2	351.1	460.5	236	419
NIMAX 353 T4 0,37kW ATEX (2G)	617	441.8	290.9	751.5	266.2	351.1	460.5	236	419
NIMAX 354 T2 3kW ATEX (2G)	617	441.8	290.9	751.5	266.2	351.1	460.5	236	419
NIMAX 354 T4 0,37kW ATEX (2G)	617	441.8	290.9	751.5	266.2	351.1	460.5	236	419
NIMAX 403 T2 4kW ATEX (2G)	689	493	326.7	837	294.3	394.6	510.5	257.5	464
NIMAX 403 T4 0,55kW ATEX (2G)	689	493	326.7	837	294.3	394.6	510.5	257.5	464
NIMAX 404 T2 5,5kW ATEX (2G)	689	493	326.7	837	294.3	394.6	510.5	257.5	464
NIMAX 404 T4 0,55kW ATEX (2G)	689	493	326.7	837	294.3	394.6	510.5	257.5	464
NIMAX 453 T2 7,5kW ATEX (2G)	768	549.3	366.2	937	325.4	442.5	570.5	286	523
NIMAX 453 T4 1,1kW ATEX (2G)	768	549.3	366.2	937	325.4	442.5	570.5	286	523
NIMAX 454 T2 9,2kW ATEX (2G)	768	549.3	366.2	937	325.4	442.5	570.5	286	523
NIMAX 454 T4 1,1kW ATEX (2G)	768	549.3	366.2	937	325.4	442.5	570.5	286	523

Model	F	G (aprox)	H	HC	J	K	M	N	N1
NIMAX 313 T2 1,5kW ATEX (2G)	354.5	508.4	490.5	415.5	264	228.5	90.5	301	221
NIMAX 313 T4 0,37kW ATEX (2G)	354.5	457.4	445.5	415.5	219	228.5	90.5	301	221

Model	F	G (aprox)	H	HC	J	K	M	N	N1
NIMAX 314 T2 1,5kW ATEX (2G)	354.5	508.4	490.5	415.5	264	228.5	90.5	301	221
NIMAX 314 T4 0,37kW ATEX (2G)	354.5	457.4	445.5	415.5	219	228.5	90.5	301	221
NIMAX 353 T2 2,2kW ATEX (2G)	394.5	543	519.5	460.5	264	257.5	105	330	250
NIMAX 353 T4 0,37kW ATEX (2G)	394.5	482	474.5	460.5	219	257.5	105	330	250
NIMAX 354 T2 3kW ATEX (2G)	394.5	577.1	579.9	460.5	324.5	257.5	105	330	250
NIMAX 354 T4 0,37kW ATEX (2G)	394.5	482	474.5	460.5	219	257.5	105	330	250
NIMAX 403 T2 4kW ATEX (2G)	438	637	615.5	510.5	329	288.5	120.6	361	281
NIMAX 403 T4 0,55kW ATEX (2G)	438	530	520.5	510.5	234	288.5	120.6	361	281
NIMAX 404 T2 5,5kW ATEX (2G)	438	721.5	680	510.5	393.4	288.5	120.6	361	281
NIMAX 404 T4 0,55kW ATEX (2G)	438	530	520.5	510.5	234	288.5	120.6	361	281
NIMAX 453 T2 7,5kW ATEX (2G)	485	733.5	715	570.5	393.5	323.5	128	396	316
NIMAX 453 T4 1,1kW ATEX (2G)	485	608.5	585.5	570.5	264	323.5	128	396	316
NIMAX 454 T2 9,2kW ATEX (2G)	485	733.5	715	570.5	393.5	323.5	128	396	316
NIMAX 454 T4 1,1kW ATEX (2G)	485	608.5	585.5	570.5	264	323.5	128	396	316

Model	O	P	R	R1	S	T	V	X1	X2
NIMAX 313 T2 1,5kW ATEX (2G)	90	95	395	315	395	43.5	325.5	314	84.3
NIMAX 313 T4 0,37kW ATEX (2G)	90	95	395	315	395	43.5	344.5	314	84.3
NIMAX 314 T2 1,5kW ATEX (2G)	90	95	395	315	395	43.5	325.5	314	84.3
NIMAX 314 T4 0,37kW ATEX (2G)	90	95	395	315	395	43.5	344.5	314	84.3
NIMAX 353 T2 2,2kW ATEX (2G)	105	105	435	355	438	47	370.5	357	87.7
NIMAX 353 T4 0,37kW ATEX (2G)	105	105	435	355	438	47	389.5	357	87.7
NIMAX 354 T2 3kW ATEX (2G)	105	105	435	355	438	47	360.5	357	87.7
NIMAX 354 T4 0,37kW ATEX (2G)	105	105	435	355	438	47	389.5	357	87.7
NIMAX 403 T2 4kW ATEX (2G)	120	120	480	400	487	50.5	398.5	406	91.3
NIMAX 403 T4 0,55kW ATEX (2G)	120	120	480	400	487	50.5	430.5	406	91.3
NIMAX 404 T2 5,5kW ATEX (2G)	120	120	480	400	487	50.5	378.5	406	91.3
NIMAX 404 T4 0,55kW ATEX (2G)	120	120	480	400	487	50.5	430.5	406	91.3
NIMAX 453 T2 7,5kW ATEX (2G)	130	130	530	450	545	53	438.5	464	93.4
NIMAX 453 T4 1,1kW ATEX (2G)	130	130	530	450	545	53	480.5	464	93.4
NIMAX 454 T2 9,2kW ATEX (2G)	130	130	530	450	545	53	438.5	464	93.4
NIMAX 454 T4 1,1kW ATEX (2G)	130	130	530	450	545	53	480.5	464	93.4

Model	X3	Y1	Y2	Y3	Z1	Z2	Z3	a°	motor
NIMAX 313 T2 1,5kW ATEX (2G)	20	269.2	106.7	20	35	152	32	22,5°	90
NIMAX 313 T4 0,37kW ATEX (2G)	20	269.2	106.7	20	35	152	32	22,5°	71
NIMAX 314 T2 1,5kW ATEX (2G)	20	269.2	106.7	20	35	152	32	22,5°	90
NIMAX 314 T4 0,37kW ATEX (2G)	20	269.2	106.7	20	35	152	32	22,5°	71
NIMAX 353 T2 2,2kW ATEX (2G)	20	269.2	131.6	20	35	197	32	22,5°	90
NIMAX 353 T4 0,37kW ATEX (2G)	20	269.2	131.6	20	35	152	32	22,5°	71

Model	X3	Y1	Y2	Y3	Z1	Z2	Z3	a°	motor
NIMAX 354 T2 3kW ATEX (2G)	20	339.8	96.3	20	35	257	32	22,5°	100
NIMAX 354 T4 0,37kW ATEX (2G)	20	269.2	131.6	20	35	152	32	22,5°	71
NIMAX 403 T2 4kW ATEX (2G)	20	339.8	124.4	20	35	262	32	22,5°	112
NIMAX 403 T4 0,55kW ATEX (2G)	20	269.2	159.7	20	35	167	32	22,5°	80
NIMAX 404 T2 5,5kW ATEX (2G)	20	369.8	109.4	20	35	327	32	22,5°	132
NIMAX 404 T4 0,55kW ATEX (2G)	20	269.2	159.7	20	35	167	32	22,5°	80
NIMAX 453 T2 7,5kW ATEX (2G)	20	369.8	140.5	20	35	327	32	22,5°	132
NIMAX 453 T4 1,1kW ATEX (2G)	20	269.2	190.8	20	35	197	32	22,5°	90
NIMAX 454 T2 9,2kW ATEX (2G)	20	369.8	140.5	20	35	327	32	22,5°	132
NIMAX 454 T4 1,1kW ATEX (2G)	20	269.2	190.8	20	35	197	32	22,5°	90

Model	n°holes
NIMAX 313 T2 1,5kW ATEX (2G)	8x45°
NIMAX 313 T4 0,37kW ATEX (2G)	8x45°
NIMAX 314 T2 1,5kW ATEX (2G)	8x45°
NIMAX 314 T4 0,37kW ATEX (2G)	8x45°
NIMAX 353 T2 2,2kW ATEX (2G)	8x45°
NIMAX 353 T4 0,37kW ATEX (2G)	8x45°
NIMAX 354 T2 3kW ATEX (2G)	8x45°
NIMAX 354 T4 0,37kW ATEX (2G)	8x45°
NIMAX 403 T2 4kW ATEX (2G)	8x45°
NIMAX 403 T4 0,55kW ATEX (2G)	8x45°
NIMAX 404 T2 5,5kW ATEX (2G)	8x45°
NIMAX 404 T4 0,55kW ATEX (2G)	8x45°
NIMAX 453 T2 7,5kW ATEX (2G)	8x45°
NIMAX 453 T4 1,1kW ATEX (2G)	8x45°
NIMAX 454 T2 9,2kW ATEX (2G)	8x45°
NIMAX 454 T4 1,1kW ATEX (2G)	8x45°

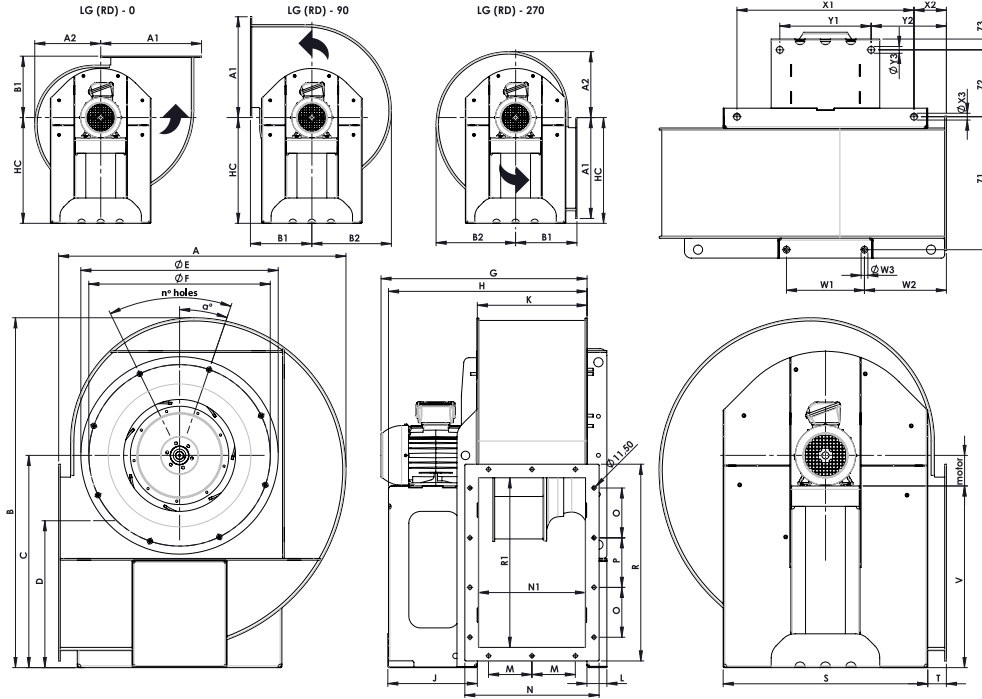

Model	A	A1	A2	B	B1	B2	C	D	E
NIMAX 503 T2 15kW ATEX (2G)	847.3	606	406	1031.52	356.6	490.7	625.62	309.6	582
NIMAX 503 T4 1,5kW ATEX (2G)	847.3	606	406	1031.52	356.6	490.7	625.62	309.6	582
NIMAX 503 T6 0,55kW ATEX (2G)	847.3	606	406	1031.52	356.6	490.7	625.62	309.6	582
NIMAX 504 T2 15kW ATEX (2G)	847.3	606	406	1031.52	356.6	490.7	625.62	309.6	582
NIMAX 504 T4 2,2kW ATEX (2G)	847.3	606	406	1031.52	356.6	490.7	625.62	309.6	582
NIMAX 504 T6 0,55kW ATEX (2G)	847.3	606	406	1031.52	356.6	490.7	625.62	309.6	582
NIMAX 563 T4 3kW ATEX (2G)	942.5	674	453.5	1148.6	394	548.5	695.1	341.1	650
NIMAX 563 T6 1,1kW ATEX (2G)	942.5	674	453.5	1148.6	394	548.5	695.1	341.1	650
NIMAX 564 T4 3kW ATEX (2G)	942.5	674	453.5	1148.6	394	548.5	695.1	341.1	650
NIMAX 564 T6 1,1kW ATEX (2G)	942.5	674	453.5	1148.6	394	548.5	695.1	341.1	650
NIMAX 633 T4 5,5kW ATEX (2G)	1053.5	753.3	509	1284	437.6	615.9	775	376.8	710
NIMAX 633 T6 1,5kW ATEX (2G)	1053.5	753.3	509	1284	437.6	615.9	775	376.8	710
NIMAX 634 T4 5,5kW ATEX (2G)	1053.5	753.3	509	1284	437.6	615.9	775	376.8	710
NIMAX 634 T6 2,2kW ATEX (2G)	1053.5	753.3	509	1284	437.6	615.9	775	376.8	710
NIMAX 713 T4 9,2kW ATEX (2G)	1180.3	843.7	572.4	1437.5	487.5	692.8	865.1	416.4	826
NIMAX 713 T6 3kW ATEX (2G)	1180.3	843.7	572.4	1437.5	487.5	692.8	865.1	416.4	826
NIMAX 714 T4 11kW ATEX (2G)	1180.3	843.7	572.4	1437.5	487.5	692.8	865.1	416.4	826
NIMAX 714 T6 3kW ATEX (2G)	1180.3	843.7	572.4	1437.5	487.5	692.8	865.1	416.4	826
NIMAX 803 T4 18,5kW ATEX (2G)	1323.1	945.7	643.8	1609	543.6	779.5	965	459.4	930
NIMAX 803 T6 5,5kW ATEX (2G)	1323.1	945.7	643.8	1609	543.6	779.5	965	459.4	930
NIMAX 803 T8 2,2kW ATEX (2G)	1323.1	945.7	643.8	1609	543.6	779.5	965	459.4	930
NIMAX 804 T4 18,5kW ATEX (2G)	1323.1	945.7	643.8	1609	543.6	779.5	965	459.4	930



Model	A	A1	A2	B	B1	B2	C	D	E
NIMAX 804 T6 5,5kW ATEX (2G)	1323.1	945.7	643.8	1609	543.6	779.5	965	459.4	930
NIMAX 804 T8 2,2kW ATEX (2G)	1323.1	945.7	643.8	1609	543.6	779.5	965	459.4	930
NIMAX 903 T4 30kW ATEX (2G)	1481.7	1059	723	1813	606	875.5	1090	521.2	1065
NIMAX 903 T6 11kW ATEX (2G)	1481.7	1059	723	1813	606	875.5	1090	521.2	1065
NIMAX 903 T8 4kW ATEX (2G)	1481.7	1059	723	1813	606	875.5	1090	521.2	1065
NIMAX 904 T4 37kW ATEX (2G)	1481.7	1059	723	1813	606	875.5	1090	521.2	1065
NIMAX 904 T6 11kW ATEX (2G)	1481.7	1059	723	1813	606	875.5	1090	521.2	1065
NIMAX 904 T8 4kW ATEX (2G)	1481.7	1059	723	1813	606	875.5	1090	521.2	1065
NIMAX 1003 T4 55kW ATEX (2G)	1640	1172	802	2002	668.2	971.8	1200	168	1172
NIMAX 1003 T6 15kW ATEX (2G)	1640	1172	802	2002	668.2	971.8	1200	168	1172
NIMAX 1003 T8 7,5kW ATEX (2G)	1640	1172	802	2002	668.2	971.8	1200	168	1172
NIMAX 1004 T4 55kW ATEX (2G)	1640	1172	802	2002	668.2	971.8	1200	168	1172
NIMAX 1004 T6 18,5kW ATEX (2G)	1640	1172	802	2002	668.2	971.8	1200	168	1172
NIMAX 1004 T8 7,5kW ATEX (2G)	1640	1172	802	2002	668.2	971.8	1200	168	1172

Model	F	G (aprox)	H	HC	J	K	L	M	N
NIMAX 503 T2 15kW ATEX (2G)	535	906	854.5	625.5	494	359.5	59	146	432
NIMAX 503 T4 1,5kW ATEX (2G)	535	643.5	621.5	625.5	264	359.5	59	146	432
NIMAX 503 T6 0,55kW ATEX (2G)	535	595.5	591.5	625.5	234	359.5	59	146	432
NIMAX 504 T2 15kW ATEX (2G)	535	906	854.5	625.5	494	359.5	59	146	432
NIMAX 504 T4 2,2kW ATEX (2G)	535	691.5	682	625.5	324.5	359.5	59	146	432
NIMAX 504 T6 0,55kW ATEX (2G)	535	595.5	591.5	625.5	234	359.5	59	146	432
NIMAX 563 T4 3kW ATEX (2G)	608	733.5	725	694.1	326.4	401.5	59	167	474
NIMAX 563 T6 1,1kW ATEX (2G)	608	684.4	664.5	694.1	264	401.5	59	167	474
NIMAX 564 T4 3kW ATEX (2G)	608	733.5	725	694.1	326.4	401.5	59	167	474
NIMAX 564 T6 1,1kW ATEX (2G)	608	684.4	664.5	694.1	264	401.5	59	167	474
NIMAX 633 T4 5,5kW ATEX (2G)	675	878.2	843	775.1	395.5	450.5	59	191.5	523.25
NIMAX 633 T6 1,5kW ATEX (2G)	675	782.8	774	775.1	326.5	450.5	59	191.5	523.25
NIMAX 634 T4 5,5kW ATEX (2G)	675	878.2	843	775.1	395.5	450.5	59	191.5	523.25
NIMAX 634 T6 2,2kW ATEX (2G)	675	786.8	778.5	775.1	331	450.5	59	191.5	523.25
NIMAX 713 T4 9,2kW ATEX (2G)	755	922	900	865.1	395.5	507.5	59	210	579.7
NIMAX 713 T6 3kW ATEX (2G)	755	922	900	865.1	395.5	507.5	59	210	579.7
NIMAX 714 T4 11kW ATEX (2G)	755	1047	1000.5	865.1	496	507.5	59	210	579.7
NIMAX 714 T6 3kW ATEX (2G)	755	922	900	865.1	395.5	507.5	59	210	579.7
NIMAX 803 T4 18,5kW ATEX (2G)	845	1165.7	1098	965.1	531.5	569.5	59	231	642.3
NIMAX 803 T6 5,5kW ATEX (2G)	845	982.5	962	965.1	395.5	569.5	59	231	642.3
NIMAX 803 T8 2,2kW ATEX (2G)	845	982.5	962	965.1	395.5	569.5	59	231	642.3
NIMAX 804 T4 18,5kW ATEX (2G)	845	1165.7	1098	965.1	531.5	569.5	59	231	642.3
NIMAX 804 T6 5,5kW ATEX (2G)	845	982.5	962	965.1	395.5	569.5	59	231	642.3
NIMAX 804 T8 2,2kW ATEX (2G)	845	982.5	962	965.1	395.5	569.5	59	231	642.3

Model	F	G (aprox)	H	HC	J	K	L	M	N
NIMAX 903 T4 30kW ATEX (2G)	987	1308.2	1224.5	1090.1	587	640.5	69	256.5	713
NIMAX 903 T6 11kW ATEX (2G)	987	1184.6	1133.5	1090.1	496	640.5	69	256.5	713
NIMAX 903 T8 4kW ATEX (2G)	987	1184.6	1133.5	1090.1	496	640.5	69	256.5	713
NIMAX 904 T4 37kW ATEX (2G)	987	1308.2	1224.5	1090.1	587	640.5	69	256.5	713
NIMAX 904 T6 11kW ATEX (2G)	987	1184.6	1133.5	1090.1	496	640.5	69	256.5	713
NIMAX 904 T8 4kW ATEX (2G)	987	1184.6	1133.5	1090.1	496	640.5	69	256.5	713
NIMAX 1003 T4 55kW ATEX (2G)	1093	1549.5	1394.5	1200	686	711.5	69	292	784
NIMAX 1003 T6 15kW ATEX (2G)	1093	1307.7	1240	1200	531.5	711.5	69	292	784
NIMAX 1003 T8 7,5kW ATEX (2G)	1093	1248.6	1204.5	1200	496	711.5	69	292	784
NIMAX 1004 T4 55kW ATEX (2G)	1093	1549.5	1394.5	1200	686	711.5	69	292	784
NIMAX 1004 T6 18,5kW ATEX (2G)	1093	1408.2	1295.5	1200	587	711.5	69	292	784
NIMAX 1004 T8 7,5kW ATEX (2G)	1093	1248.6	1204.5	1200	496	711.5	69	292	784

Model	N1	O	P	R	R1	S	T	V	W1
NIMAX 503 T2 15kW ATEX (2G)	352	147	146	580	500	603	55	465.62	230
NIMAX 503 T4 1,5kW ATEX (2G)	352	147	146	580	500	603	55	535.62	230
NIMAX 503 T6 0,55kW ATEX (2G)	352	147	146	580	500	603	55	545.62	230
NIMAX 504 T2 15kW ATEX (2G)	352	147	146	580	500	603	55	465.62	230
NIMAX 504 T4 2,2kW ATEX (2G)	352	147	146	580	500	603	55	525.62	230
NIMAX 504 T6 0,55kW ATEX (2G)	352	147	146	580	500	603	55	545.62	230
NIMAX 563 T4 3kW ATEX (2G)	394	165	170	640	560	673.4	57.3	595.1	250
NIMAX 563 T6 1,1kW ATEX (2G)	394	165	170	640	560	673.4	57.3	605.1	250
NIMAX 564 T4 3kW ATEX (2G)	394	165	170	640	560	673.4	57.3	595.1	250
NIMAX 564 T6 1,1kW ATEX (2G)	394	165	170	640	560	673.4	57.3	605.1	250
NIMAX 633 T4 5,5kW ATEX (2G)	443	190	190	710	630	754.4	60.4	643	330
NIMAX 633 T6 1,5kW ATEX (2G)	443	190	190	710	630	754.4	60.4	675	330
NIMAX 634 T4 5,5kW ATEX (2G)	443	190	190	710	630	754.4	60.4	643	330
NIMAX 634 T6 2,2kW ATEX (2G)	443	190	190	710	630	754.4	60.4	663	330
NIMAX 713 T4 9,2kW ATEX (2G)	500	210	210	790	710	847.4	63.8	733.1	350
NIMAX 713 T6 3kW ATEX (2G)	500	210	210	790	710	847.4	63.8	733.1	350
NIMAX 714 T4 11kW ATEX (2G)	500	210	210	790	710	847.4	63.8	705.1	350
NIMAX 714 T6 3kW ATEX (2G)	500	210	210	790	710	847.4	63.8	733.1	350
NIMAX 803 T4 18,5kW ATEX (2G)	562	233	234	880	800	951.5	67.9	785	450
NIMAX 803 T6 5,5kW ATEX (2G)	562	233	234	880	800	951.5	67.9	833	450
NIMAX 803 T8 2,2kW ATEX (2G)	562	233	234	880	800	951.5	67.9	833	450
NIMAX 804 T4 18,5kW ATEX (2G)	562	233	234	880	800	951.5	67.9	785	450
NIMAX 804 T6 5,5kW ATEX (2G)	562	233	234	880	800	951.5	67.9	833	450
NIMAX 804 T8 2,2kW ATEX (2G)	562	233	234	880	800	951.5	67.9	833	450
NIMAX 903 T4 30kW ATEX (2G)	633	260	260	980	800	1081.4	65.2	890	510
NIMAX 903 T6 11kW ATEX (2G)	633	260	260	980	800	1081.4	65.2	930	510

Model	N1	O	P	R	R1	S	T	V	W1
NIMAX 903 T8 4kW ATEX (2G)	633	260	260	980	800	1081.4	65.2	930	510
NIMAX 904 T4 37kW ATEX (2G)	633	260	260	980	800	1081.4	65.2	865	510
NIMAX 904 T6 11kW ATEX (2G)	633	260	260	980	800	1081.4	65.2	930	510
NIMAX 904 T8 4kW ATEX (2G)	633	260	260	980	800	1081.4	65.2	930	510
NIMAX 1003 T4 55kW ATEX (2G)	704	293	294	1080	1000	1201.4	67.5	950	600
NIMAX 1003 T6 15kW ATEX (2G)	704	293	294	1080	1000	1201.4	67.5	1020	600
NIMAX 1003 T8 7,5kW ATEX (2G)	704	293	294	1080	1000	1201.4	67.5	1040	600
NIMAX 1004 T4 55kW ATEX (2G)	704	293	294	1080	1000	1201.4	67.5	950	600
NIMAX 1004 T6 18,5kW ATEX (2G)	704	293	294	1080	1000	1201.4	67.5	1000	600
NIMAX 1004 T8 7,5kW ATEX (2G)	704	293	294	1080	1000	1201.4	67.5	1040	600

Model	W2	W3	X1	X2	X3	Y1	Y2	Y3	Z1
NIMAX 503 T2 15kW ATEX (2G)	241.6	20	522	95.6	20	431.2	141	20	428
NIMAX 503 T4 1,5kW ATEX (2G)	241.6	20	522	95.6	20	269.2	222	20	428
NIMAX 503 T6 0,55kW ATEX (2G)	241.6	20	522	95.6	20	269.2	222	20	428
NIMAX 504 T2 15kW ATEX (2G)	241.6	20	522	95.6	20	431.2	141	20	428
NIMAX 504 T4 2,2kW ATEX (2G)	241.6	20	522	95.6	20	339.5	186.7	20	428
NIMAX 504 T6 0,55kW ATEX (2G)	241.6	20	522	95.6	20	269.2	222	20	428
NIMAX 563 T4 3kW ATEX (2G)	269	20	592	98	20	339.8	224.1	20	470.7
NIMAX 563 T6 1,1kW ATEX (2G)	269	20	592	98	20	269.2	259.4	20	470.7
NIMAX 564 T4 3kW ATEX (2G)	269	20	592	98	20	339.8	224.1	20	470.7
NIMAX 564 T6 1,1kW ATEX (2G)	269	20	592	98	20	269.2	259.4	20	470.7
NIMAX 633 T4 5,5kW ATEX (2G)	272.6	20	673	101.1	20	369.8	252.7	20	519.7
NIMAX 633 T6 1,5kW ATEX (2G)	272.6	20	673	101.1	20	339.8	267.7	20	519.7
NIMAX 634 T4 5,5kW ATEX (2G)	272.6	20	673	101.1	20	369.8	252.7	20	519.7
NIMAX 634 T6 2,2kW ATEX (2G)	272.6	20	673	101.1	20	339.8	267.7	20	519.7
NIMAX 713 T4 9,2kW ATEX (2G)	312.5	20	766	104.5	20	369.8	302.6	20	276.7
NIMAX 713 T6 3kW ATEX (2G)	312.5	20	766	104.5	20	369.8	302.6	20	276.7
NIMAX 714 T4 11kW ATEX (2G)	312.5	20	766	104.5	20	431.2	271.9	20	276.7
NIMAX 714 T6 3kW ATEX (2G)	312.5	20	766	104.5	20	369.8	302.6	20	276.7
NIMAX 803 T4 18,5kW ATEX (2G)	318.6	20	870	108.6	20	461.2	313	20	638.7
NIMAX 803 T6 5,5kW ATEX (2G)	318.6	20	870	108.6	20	369.8	358.7	20	638.7
NIMAX 803 T8 2,2kW ATEX (2G)	318.6	20	870	108.6	20	369.8	358.7	20	638.7
NIMAX 804 T4 18,5kW ATEX (2G)	318.6	20	870	108.6	20	461.2	313	20	638.7
NIMAX 804 T6 5,5kW ATEX (2G)	318.6	20	870	108.6	20	369.8	358.7	20	638.7
NIMAX 804 T8 2,2kW ATEX (2G)	318.6	20	870	108.6	20	369.8	358.7	20	638.7
NIMAX 903 T4 30kW ATEX (2G)	351	20	1000	106	20	571	320.3	20	719.7
NIMAX 903 T6 11kW ATEX (2G)	351	20	1000	106	20	431.2	390.3	20	719.7
NIMAX 903 T8 4kW ATEX (2G)	351	20	1000	106	20	431.2	390.3	20	719.7
NIMAX 904 T4 37kW ATEX (2G)	351	20	1000	106	20	571	320.3	20	719.7

Model	W2	W3	X1	X2	X3	Y1	Y2	Y3	Z1
NIMAX 904 T6 11kW ATEX (2G)	351	20	1000	106	20	431.2	390.3	20	719.7
NIMAX 904 T8 4kW ATEX (2G)	351	20	1000	106	20	431.2	390.3	20	719.7
NIMAX 1003 T4 55kW ATEX (2G)	368.2	20	1120	108.2	20	621	357.6	20	790.7
NIMAX 1003 T6 15kW ATEX (2G)	368.2	20	1120	108.2	20	461.2	437.6	20	790.7
NIMAX 1003 T8 7,5kW ATEX (2G)	368.2	20	1120	108.2	20	431.2	452.6	20	790.7
NIMAX 1004 T4 55kW ATEX (2G)	368.2	20	1120	108.2	20	621	357.6	20	790.7
NIMAX 1004 T6 18,5kW ATEX (2G)	368.2	20	1120	108.2	20	571	382.6	20	790.7
NIMAX 1004 T8 7,5kW ATEX (2G)	368.2	20	1120	108.2	20	431.2	452.6	20	790.7

Model	Z2	Z3	a°	motor	n°holes
NIMAX 503 T2 15kW ATEX (2G)	427	20	19°	160	8x45°
NIMAX 503 T4 1,5kW ATEX (2G)	197	20	19°	90	8x45°
NIMAX 503 T6 0,55kW ATEX (2G)	167	20	19°	80	8x45°
NIMAX 504 T2 15kW ATEX (2G)	427	20	19°	160	8x45°
NIMAX 504 T4 2,2kW ATEX (2G)	257	20	19°	100	8x45°
NIMAX 504 T6 0,55kW ATEX (2G)	167	20	19°	80	8x45°
NIMAX 563 T4 3kW ATEX (2G)	257	33.5	15°	100	12x30°
NIMAX 563 T6 1,1kW ATEX (2G)	197	33.5	15°	90	12x30°
NIMAX 564 T4 3kW ATEX (2G)	257	33.5	15°	100	12x30°
NIMAX 564 T6 1,1kW ATEX (2G)	197	33.5	15°	90	12x30°
NIMAX 633 T4 5,5kW ATEX (2G)	327	32.5	0°	132	12x30°
NIMAX 633 T6 1,5kW ATEX (2G)	257	32.5	0°	100	12x30°
NIMAX 634 T4 5,5kW ATEX (2G)	327	32.5	0°	132	12x30°
NIMAX 634 T6 2,2kW ATEX (2G)	262	32.5	0°	112	12x30°
NIMAX 713 T4 9,2kW ATEX (2G)	327	32.5	5°	132	16x22,5°
NIMAX 713 T6 3kW ATEX (2G)	327	32.5	5°	132	16x22,5°
NIMAX 714 T4 11kW ATEX (2G)	427	32.5	5°	160	16x22,5°
NIMAX 714 T6 3kW ATEX (2G)	327	32.5	5°	132	16x22,5°
NIMAX 803 T4 18,5kW ATEX (2G)	462	33.5	11,25°	180	16x22,5°
NIMAX 803 T6 5,5kW ATEX (2G)	327	33.5	11,25°	132	16x22,5°
NIMAX 803 T8 2,2kW ATEX (2G)	327	33.5	11,25°	132	16x22,5°
NIMAX 804 T4 18,5kW ATEX (2G)	462	33.5	11,25°	180	16x22,5°
NIMAX 804 T6 5,5kW ATEX (2G)	327	33.5	11,25°	132	16x22,5°
NIMAX 804 T8 2,2kW ATEX (2G)	327	33.5	11,25°	132	16x22,5°
NIMAX 903 T4 30kW ATEX (2G)	518	33.5	16°	200	16x22,5°
NIMAX 903 T6 11kW ATEX (2G)	427	33.5	16°	160	16x22,5°
NIMAX 903 T8 4kW ATEX (2G)	427	33.5	16°	160	16x22,5°
NIMAX 904 T4 37kW ATEX (2G)	518	33.5	16°	225	16x22,5°
NIMAX 904 T6 11kW ATEX (2G)	427	33.5	16°	160	16x22,5°
NIMAX 904 T8 4kW ATEX (2G)	427	33.5	16°	160	16x22,5°

Model	Z2	Z3	a°	motor	n°holes
NIMAX 1003 T4 55kW ATEX (2G)	617	33.5	11,25°	250	16x22,5°
NIMAX 1003 T6 15kW ATEX (2G)	462	33.5	11,25°	180	16x22,5°
NIMAX 1003 T8 7,5kW ATEX (2G)	427	33.5	11,25°	160	16x22,5°
NIMAX 1004 T4 55kW ATEX (2G)	617	33.5	11,25°	250	16x22,5°
NIMAX 1004 T6 18,5kW ATEX (2G)	518	33.5	11,25°	200	16x22,5°
NIMAX 1004 T8 7,5kW ATEX (2G)	427	33.5	11,25°	160	16x22,5°

# Wiring diagram

DIAGRAM N° 1

230/400V

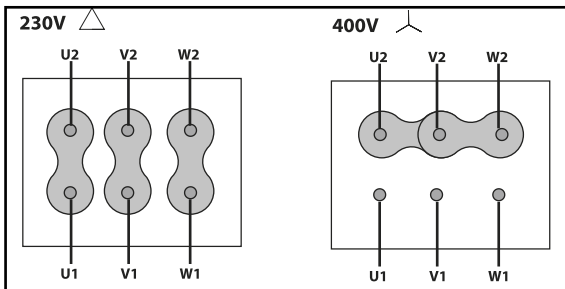

400/690V

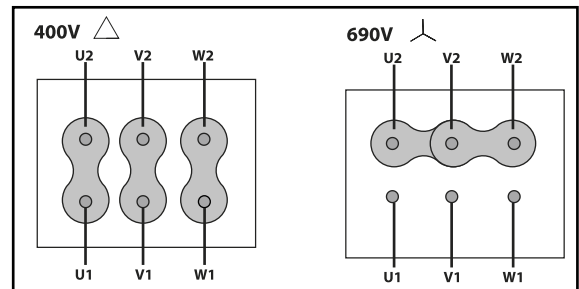

## CHARACTERISTIC CURVE

1	NIMAX 313 T2 1,5kW ATEX (2G)	2	NIMAX 314 T2 1,5kW ATEX (2G)	3	NIMAX 353 T2 2,2kW ATEX (2G)	4	NIMAX 354 T2 3kW ATEX (2G)
5	NIMAX 403 T2 4kW ATEX (2G)	6	NIMAX 404 T2 5,5kW ATEX (2G)	7	NIMAX 453 T2 7,5kW ATEX (2G)	8	NIMAX 454 T2 9,2kW ATEX (2G)
9	NIMAX 503 T2 15kW ATEX (2G)	10	NIMAX 504 T2 15kW ATEX (2G)				

### AIR FLOW - PRESSURE

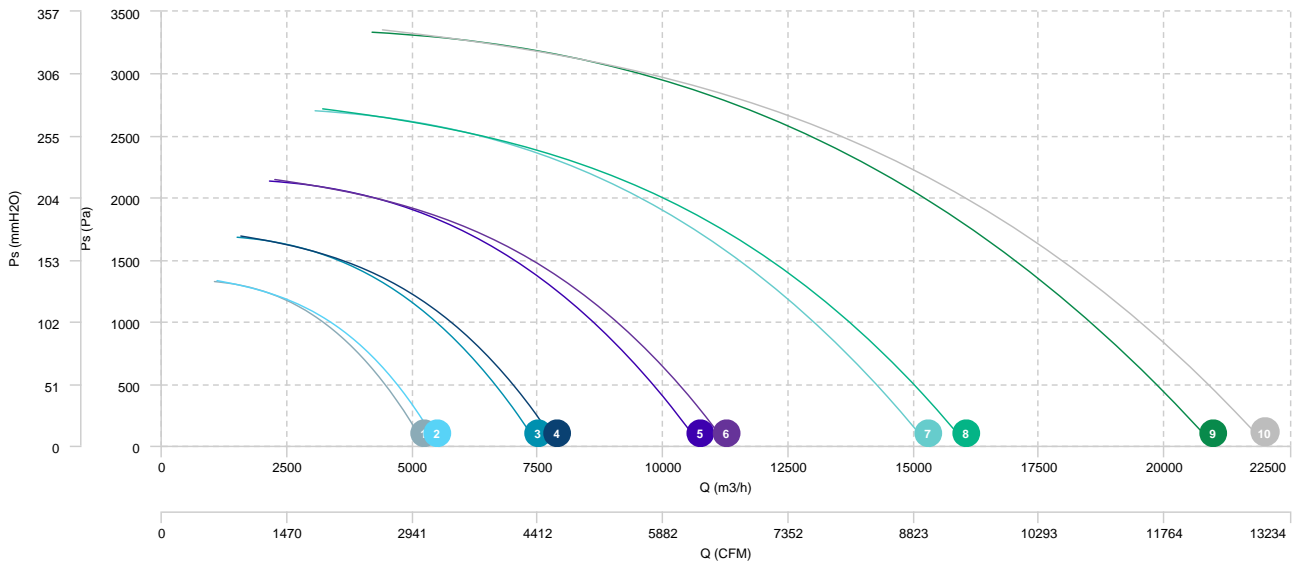

### AIR FLOW - ABSORBED POWER

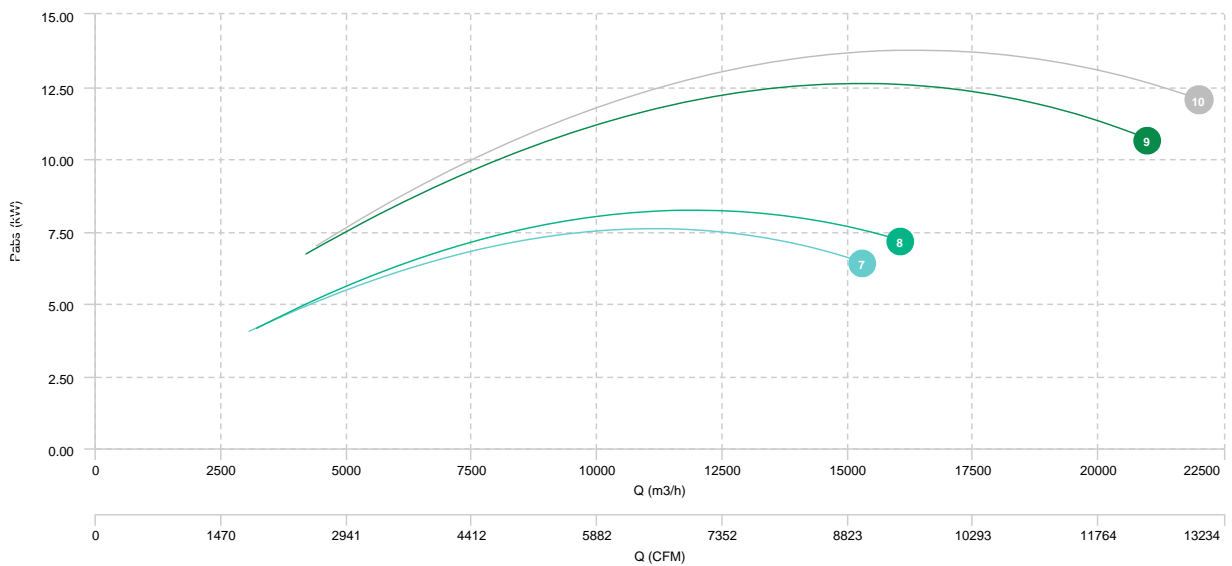

1	NIMAX 313 T4 0,37kW ATEX (2G)	2	NIMAX 314 T4 0,37kW ATEX (2G)	3	NIMAX 353 T4 0,37kW ATEX (2G)	4	NIMAX 354 T4 0,37kW ATEX (2G)
5	NIMAX 403 T4 0,55kW ATEX (2G)	6	NIMAX 404 T4 0,55kW ATEX (2G)	7	NIMAX 453 T4 1,1kW ATEX (2G)	8	NIMAX 454 T4 1,1kW ATEX (2G)
9	NIMAX 503 T4 1,5kW ATEX (2G)	10	NIMAX 504 T4 2,2kW ATEX (2G)	11	NIMAX 563 T4 3kW ATEX (2G)		

## AIR FLOW - PRESSURE

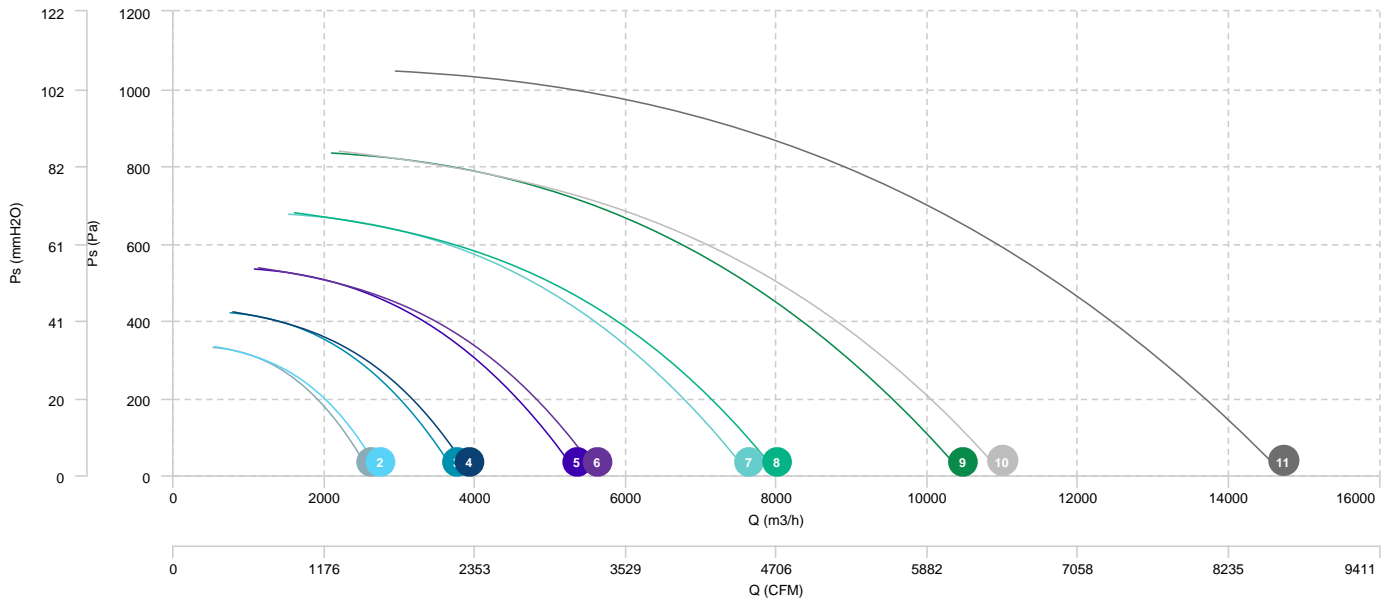



1	NIMAX 564 T4 3kW ATEX (2G)	2	NIMAX 633 T4 5,5kW ATEX (2G)	3	NIMAX 634 T4 5,5kW ATEX (2G)	4	NIMAX 713 T4 9,2kW ATEX (2G)
5	NIMAX 714 T4 11kW ATEX (2G)	6	NIMAX 803 T4 18,5kW ATEX (2G)	7	NIMAX 804 T4 18,5kW ATEX (2G)	8	NIMAX 903 T4 30kW ATEX (2G)
9	NIMAX 904 T4 37kW ATEX (2G)	10	NIMAX 1003 T4 55kW ATEX (2G)	11	NIMAX 1004 T4 55kW ATEX (2G)		

## AIR FLOW - PRESSURE

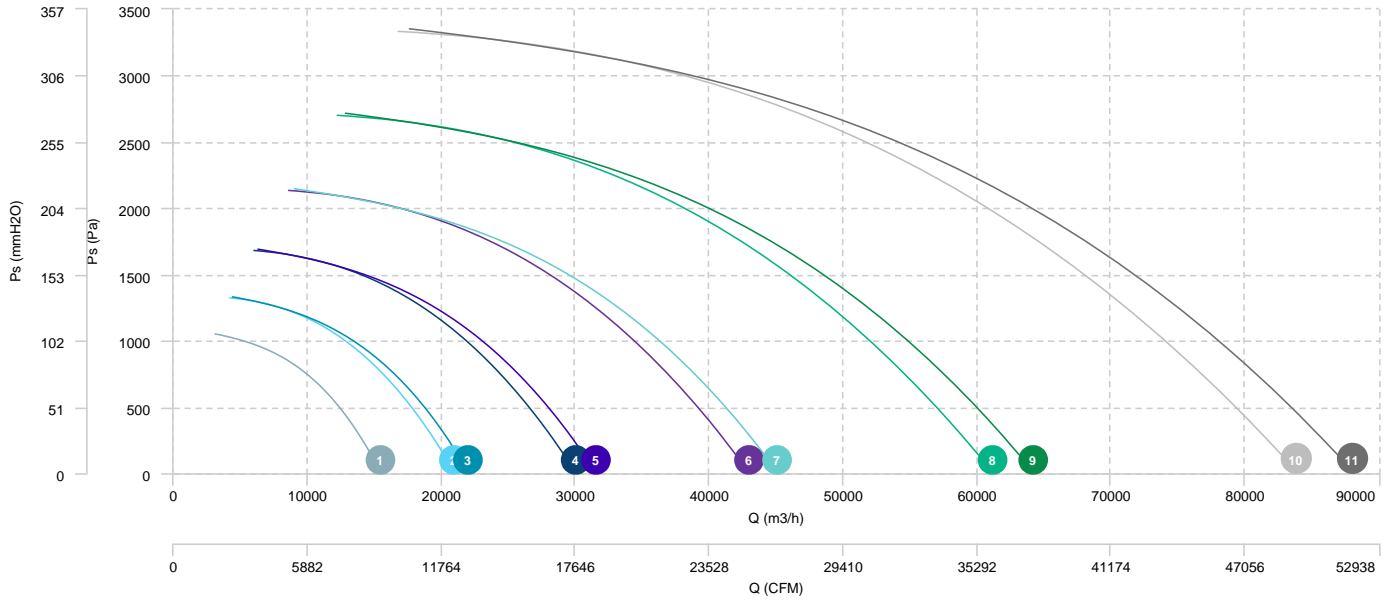

## AIR FLOW - ABSORBED POWER

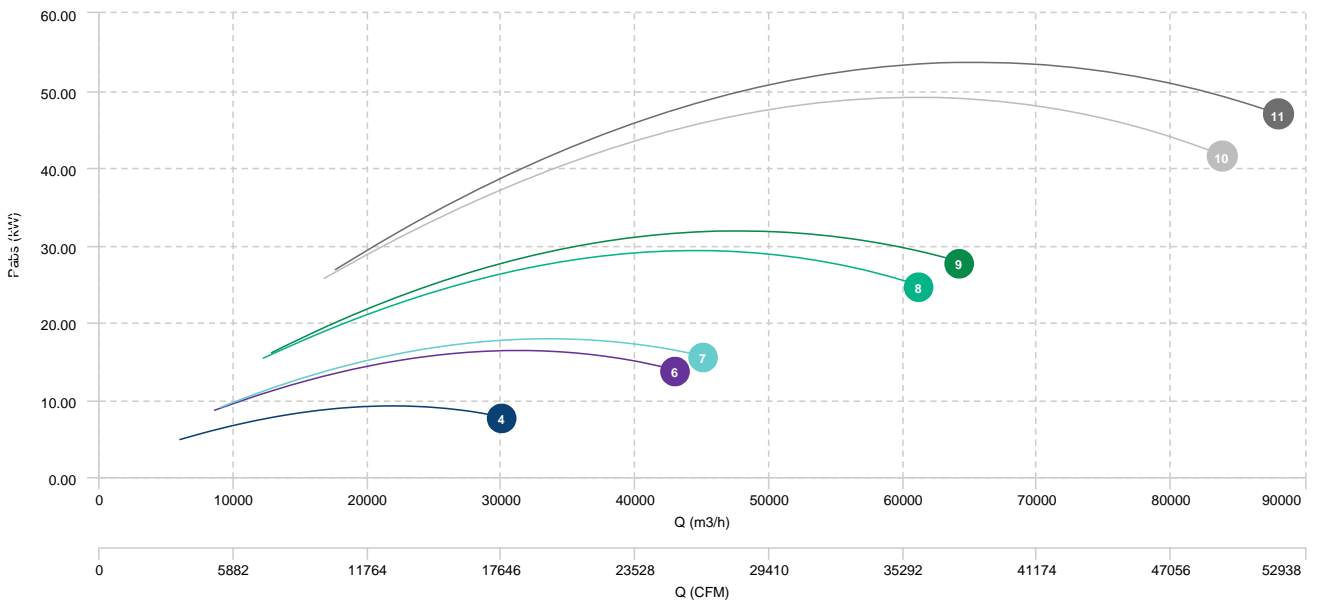

1	NIMAX 503 T6 0,55kW ATEX (2G)	2	NIMAX 504 T6 0,55kW ATEX (2G)	3	NIMAX 563 T6 1,1kW ATEX (2G)	4	NIMAX 564 T6 1,1kW ATEX (2G)
5	NIMAX 633 T6 1,5kW ATEX (2G)	6	NIMAX 634 T6 2,2kW ATEX (2G)	7	NIMAX 713 T6 3kW ATEX (2G)		

## AIR FLOW - PRESSURE

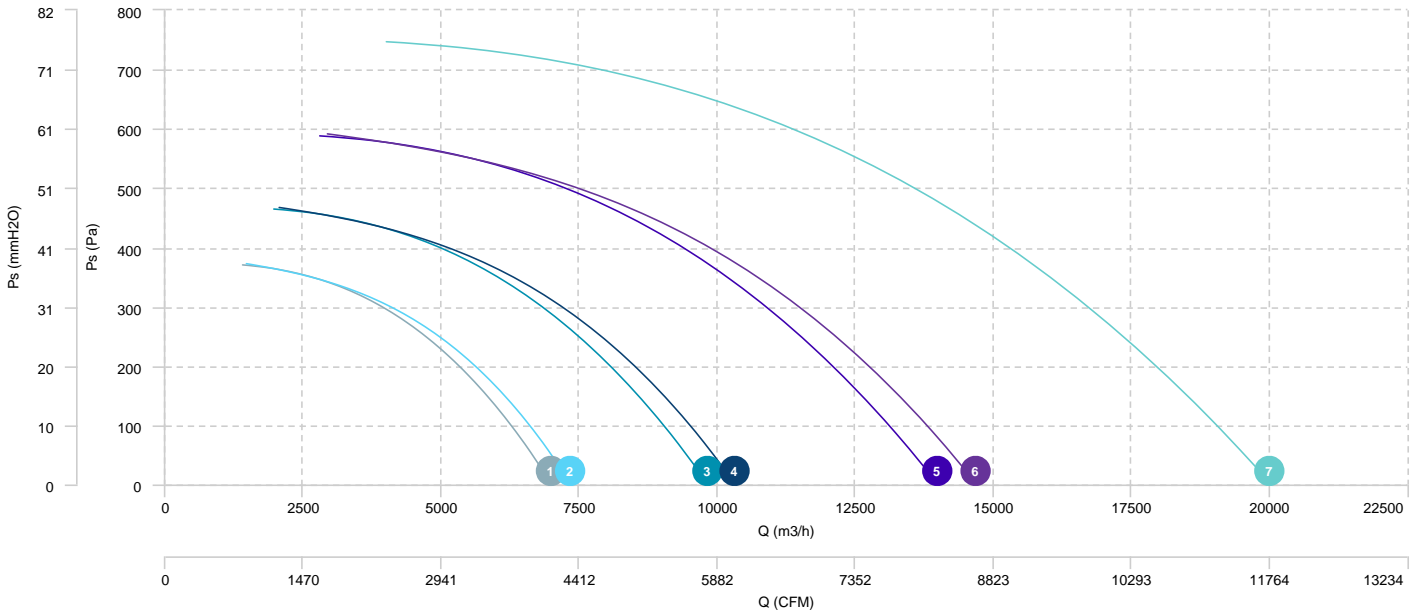

1	NIMAX 714 T6 3kW ATEX (2G)	2	NIMAX 803 T6 5,5kW ATEX (2G)	3	NIMAX 804 T6 5,5kW ATEX (2G)	4	NIMAX 903 T6 11kW ATEX (2G)
5	NIMAX 904 T6 11kW ATEX (2G)	6	NIMAX 1003 T6 15kW ATEX (2G)	7	NIMAX 1004 T6 18,5kW ATEX (2G)		

## AIR FLOW - PRESSURE

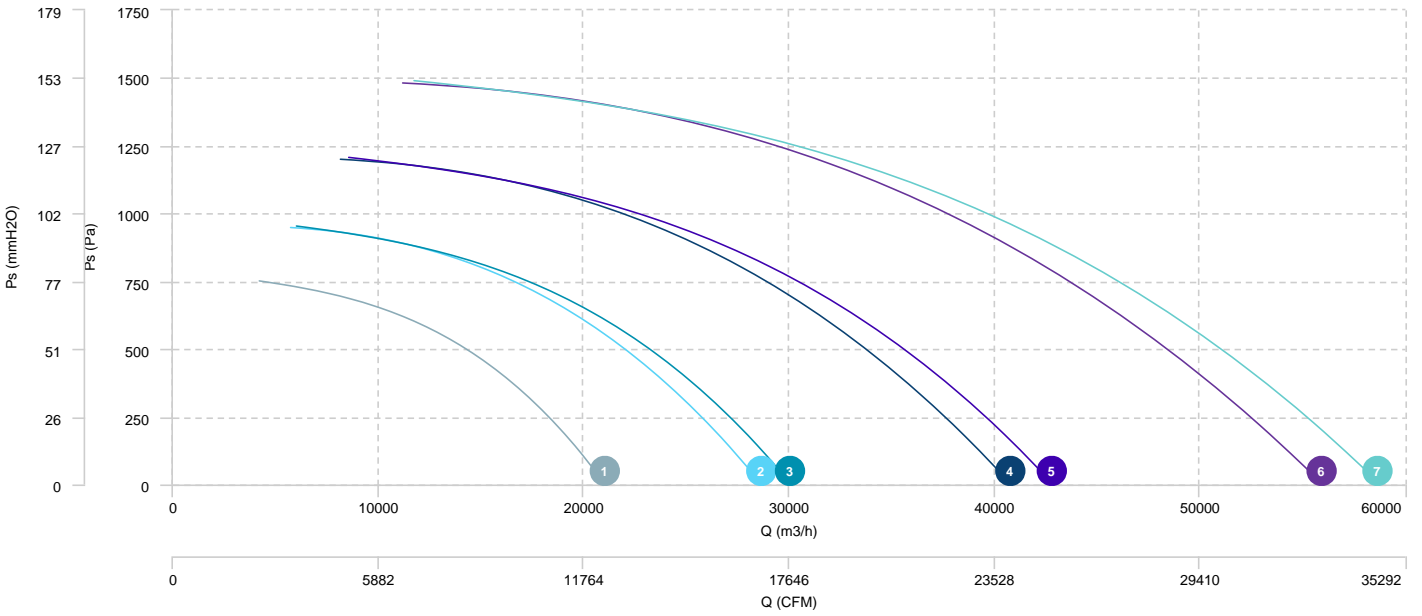

## AIR FLOW - ABSORBED POWER

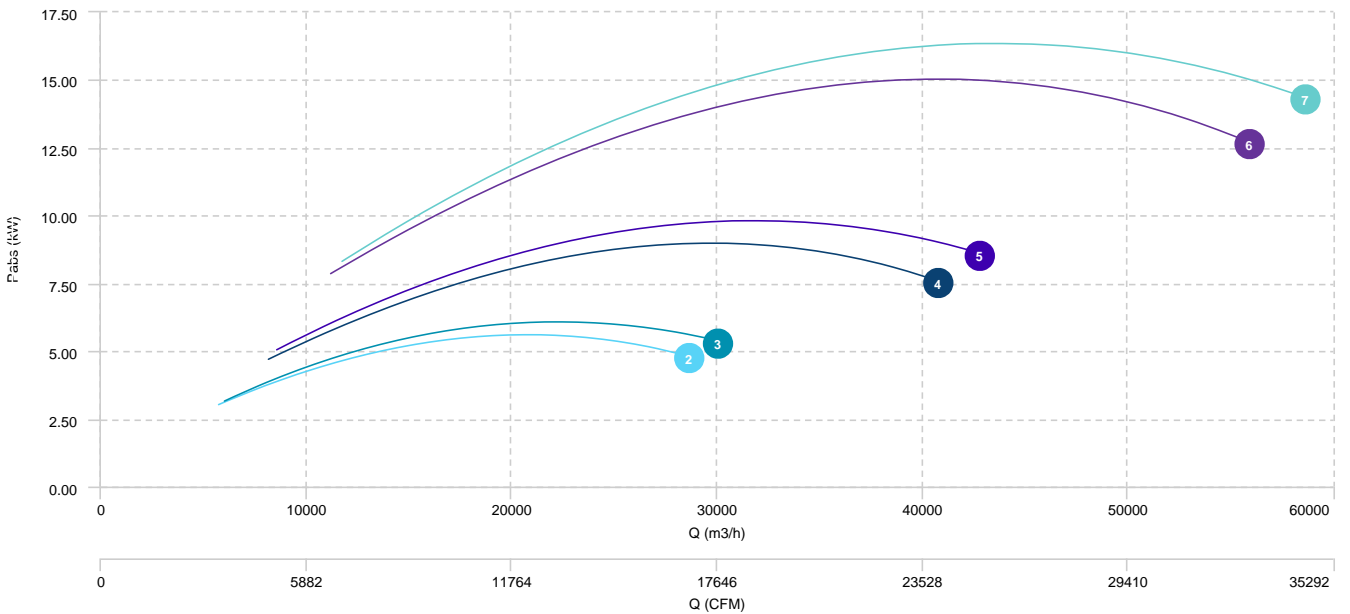

1	NIMAX 803 T8 2,2kW ATEX (2G)	2	NIMAX 804 T8 2,2kW ATEX (2G)	3	NIMAX 903 T8 4kW ATEX (2G)	4	NIMAX 904 T8 4kW ATEX (2G)
5	NIMAX 1003 T8 7,5kW ATEX (2G)	6	NIMAX 1004 T8 7,5kW ATEX (2G)				

## AIR FLOW - PRESSURE

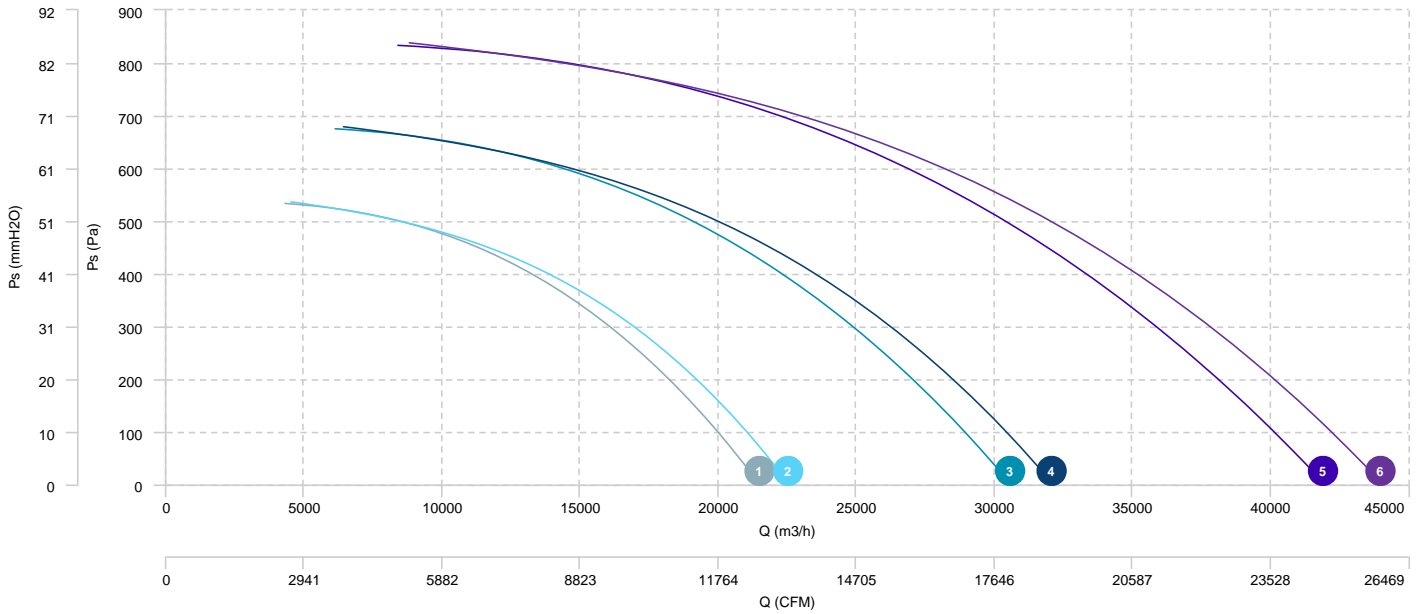

## Sound data

### Sound / 2 poles

Sound power Lw dB (A)										
Model		63 Hz	125 Hz	250 Hz	500 Hz	1000 Hz	2000 Hz	4000 Hz	8000 Hz	Total
NIMAX 313 T2 1,5kW ATEX (2G)	Inlet	82	80	77	75	73	70	67	64	86
NIMAX 314 T2 1,5kW ATEX (2G)	Inlet	82	80	77	75	73	70	67	64	86
NIMAX 353 T2 2,2kW ATEX (2G)	Inlet	85	83	80	78	76	73	70	67	89
NIMAX 354 T2 3kW ATEX (2G)	Inlet	86	84	81	79	77	74	71	68	90
NIMAX 403 T2 4kW ATEX (2G)	Inlet	89	87	84	82	80	77	74	71	93
NIMAX 404 T2 5,5kW ATEX (2G)	Inlet	89	87	84	82	80	77	74	71	93
NIMAX 453 T2 7,5kW ATEX (2G)	Inlet	92	90	87	85	83	80	77	74	96
NIMAX 454 T2 9,2kW ATEX (2G)	Inlet	93	91	88	86	84	81	78	75	97
NIMAX 503 T2 15kW ATEX (2G)	Inlet	96	94	91	89	87	84	81	78	100
NIMAX 504 T2 15kW ATEX (2G)	Inlet	96	94	91	89	87	84	81	78	100

### Sound / 4 poles

Sound power Lw dB (A)										
Model		63 Hz	125 Hz	250 Hz	500 Hz	1000 Hz	2000 Hz	4000 Hz	8000 Hz	Total
NIMAX 313 T4 0,37kW ATEX (2G)	Inlet	67	65	62	60	58	55	52	49	71
NIMAX 314 T4 0,37kW ATEX (2G)	Inlet	67	65	62	60	58	55	52	49	71
NIMAX 353 T4 0,37kW ATEX (2G)	Inlet	70	68	65	63	61	58	55	52	74
NIMAX 354 T4 0,37kW ATEX (2G)	Inlet	71	69	66	64	62	59	56	53	75
NIMAX 403 T4 0,55kW ATEX (2G)	Inlet	74	72	69	67	65	62	59	56	78
NIMAX 404 T4 0,55kW ATEX (2G)	Inlet	74	72	69	67	65	62	59	56	78
NIMAX 453 T4 1,1kW ATEX (2G)	Inlet	77	75	72	70	68	65	62	59	81
NIMAX 454 T4 1,1kW ATEX (2G)	Inlet	78	76	73	71	69	66	63	60	82
NIMAX 503 T4 1,5kW ATEX (2G)	Inlet	81	79	76	74	72	69	66	63	85
NIMAX 504 T4 2,2kW ATEX (2G)	Inlet	81	79	76	74	72	69	66	63	85
NIMAX 563 T4 3kW ATEX (2G)	Inlet	84	82	79	77	75	72	69	66	88
NIMAX 564 T4 3kW ATEX (2G)	Inlet	85	83	80	78	76	73	70	67	89
NIMAX 633 T4 5,5kW ATEX (2G)	Inlet	88	86	83	81	79	76	73	70	92
NIMAX 634 T4 5,5kW ATEX (2G)	Inlet	88	86	83	81	79	76	73	70	92
NIMAX 713 T4 9,2kW ATEX (2G)	Inlet	91	89	86	84	82	79	76	73	95
NIMAX 714 T4 11kW ATEX (2G)	Inlet	92	90	87	85	83	80	77	74	96
NIMAX 803 T4 18,5kW ATEX (2G)	Inlet	95	93	90	88	86	83	80	77	99
NIMAX 804 T4 18,5kW ATEX (2G)	Inlet	95	93	90	88	86	83	80	77	99
NIMAX 903 T4 30kW ATEX (2G)	Inlet	98	96	93	91	89	86	83	80	102
NIMAX 904 T4 37kW ATEX (2G)	Inlet	99	97	94	92	90	87	84	81	103
NIMAX 1003 T4 55kW ATEX (2G)	Inlet	102	100	97	95	93	90	87	84	106

Sound power Lw dB (A)										
Model		63 Hz	125 Hz	250 Hz	500 Hz	1000 Hz	2000 Hz	4000 Hz	8000 Hz	Total
NIMAX 1004 T4 55kW ATEX (2G)	Inlet	102	100	97	95	93	90	87	84	106

## Sound / 6 poles

Sound power Lw dB (A)										
Model		63 Hz	125 Hz	250 Hz	500 Hz	1000 Hz	2000 Hz	4000 Hz	8000 Hz	Total
NIMAX 503 T6 0,55kW ATEX (2G)	Inlet	72	70	67	65	63	60	57	54	76
NIMAX 504 T6 0,55kW ATEX (2G)	Inlet	72	70	67	65	63	60	57	54	76
NIMAX 563 T6 1,1kW ATEX (2G)	Inlet	75	73	70	68	66	63	60	57	79
NIMAX 564 T6 1,1kW ATEX (2G)	Inlet	76	74	71	69	67	64	61	58	80
NIMAX 633 T6 1,5kW ATEX (2G)	Inlet	79	77	74	72	70	67	64	61	83
NIMAX 634 T6 2,2kW ATEX (2G)	Inlet	79	77	74	72	70	67	64	61	83
NIMAX 713 T6 3kW ATEX (2G)	Inlet	82	80	77	75	73	70	67	64	86
NIMAX 714 T6 3kW ATEX (2G)	Inlet	83	81	78	76	74	71	68	65	87
NIMAX 803 T6 5,5kW ATEX (2G)	Inlet	86	84	81	79	77	74	71	68	90
NIMAX 804 T6 5,5kW ATEX (2G)	Inlet	87	85	82	80	78	75	72	69	91
NIMAX 903 T6 11kW ATEX (2G)	Inlet	90	88	85	83	81	78	75	72	94
NIMAX 904 T6 11kW ATEX (2G)	Inlet	90	88	85	83	81	78	75	72	94
NIMAX 1003 T6 15kW ATEX (2G)	Inlet	93	91	88	86	84	81	78	75	97
NIMAX 1004 T6 18,5kW ATEX (2G)	Inlet	93	91	88	86	84	81	78	75	97

## Sound / 8 poles

Sound power Lw dB (A)										
Model		63 Hz	125 Hz	250 Hz	500 Hz	1000 Hz	2000 Hz	4000 Hz	8000 Hz	Total
NIMAX 803 T8 2,2kW ATEX (2G)	Inlet	79	77	74	72	70	67	64	61	83
NIMAX 804 T8 2,2kW ATEX (2G)	Inlet	80	78	75	73	71	68	65	62	84
NIMAX 903 T8 4kW ATEX (2G)	Inlet	83	81	78	76	74	71	68	65	87
NIMAX 904 T8 4kW ATEX (2G)	Inlet	83	81	78	76	74	71	68	65	87
NIMAX 1003 T8 7,5kW ATEX (2G)	Inlet	86	84	81	79	77	74	71	68	90
NIMAX 1004 T8 7,5kW ATEX (2G)	Inlet	87	85	82	80	78	75	72	69	91