

## HBFX (F400+ATEX)



Axial fan 400°C/2h

### MANUFACTURING FEATURES

- Axial fan with circular reinforced frame.
- Modular motor-impeller assembly.
- Cast aluminium impeller with variable pitch angle. Polyester powder finishing coat.
- Standard asynchronous squirrel cage motor with IP-55 protection and Class H insulation certified 400°C/2h. Standard voltages 230/400V 50Hz in three phase motors up to 4kW and 400/690V 50Hz for higher powers.

### APPLICATIONS

Designed for wall or duct installation, they are suitable for:

- Smoke emergency exhaust with motor inside the hazardous area and high pressures needed.
- Maximum working temperature: 60°C.

### UNDER REQUEST

- B Form impeller (air flow from impeller to motor).
- 100% reversible impeller.

Official homologation by the European laboratory APPLUS according to EN 12101-3:2002, EN 12101-3:2002/AC:2005  
 Certification Nr: 0370-CPR-0914

## Accessories



AC



BA-400



CPM



INT



INT 400



MC HB



RP0



RP1



SFC

## Technical data

### Three-phase motor / 4 poles

Code	Model	R.P.M.	Rated I. (A) 400V	Rated power kW	Max. Airflow m3/h	Sound db (A)**	Weight	Connect. diagram
26047606__FX	HBFX 45 T4 0,75kW (A5:6)	1404	1,95	0,75	6.650	50	22	1
26050606__FX	HBFX 50 T4 0,75kW (A5:6)	1404	1,95	0,75	8.760	52	30	1
26058656__FX	HBFX 56 T4 0,75kW (A5:6)	1404	1,95	0,75	10.270	59	58	1
26060656__FX	HBFX 56 T4 1,1kW (A5:6)	1392	2,7	1,10	11.890	56	63	1
26061656__FX	HBFX 56 T4 1,5kW (A5:6)	1410	3,6	1,50	13.870	58	64	1
26065656__FX	HBFX 63 T4 0,75kW (A5:6)	1404	1,95	0,75	11.420	60	54	1
26066656__FX	HBFX 63 T4 1,1kW (A5:6)	1392	2,7	1,10	14.010	61	59	1
26067656__FX	HBFX 63 T4 1,5kW (A5:6)	1410	3,6	1,50	15.780	59	60	1
26068656__FX	HBFX 63 T4 2,2kW (A5:6)	1420	4,55	2,20	17.690	59	66	1
26072656__FX	HBFX 71 T4 0,75kW (A5:6)	1404	1,95	0,75	12.950	65	64	1
26073656__FX	HBFX 71 T4 1,1kW (A5:6)	1392	2,7	1,10	15.960	64	66	1
26074656__FX	HBFX 71 T4 1,5kW (A5:6)	1410	3,6	1,50	18.960	63	67	1
26075656__FX	HBFX 71 T4 2,2kW (A5:6)	1420	4,55	2,20	22.040	62	69	1
26076656__FX	HBFX 71 T4 3kW (A5:6)	1420	6,12	3	23.900	65	72	1
26084656__FX	HBFX 80 T4 3kW (A5:6)	1420	6,12	3	29.500	68	80	1
26085656__FX	HBFX 80 T4 4kW (A5:6)	1428	8,57	4	32.300	65	93	1
26093634__FX	HBFX 90 T4 3kW (A3:4)	1420	6,12	3	27.600	67	89	1
26094634__FX	HBFX 90 T4 4kW (A3:4)	1428	8,57	4	32.700	65	102	1
26095634__FX	HBFX 90 T4 5,5kW (A3:4)	1450	10,58	5,50	39.500	64	115	1
26095638__FX	HBFX 90 T4 5,5kW (A3:8)	1450	10,58	5,50	32.000	72	119	1
26096634__FX	HBFX 90 T4 7,5kW (A3:4)	1453	14,46	7,50	44.600	65	129	1
26096638__FX	HBFX 90 T4 7,5kW (A3:8)	1453	14,46	7,50	37.100	69	133	1
26097634__FX	HBFX 90 T4 11kW (A3:4)	1470	21,2	11	46.300	65	159	1
26097638__FX	HBFX 90 T4 11kW (A3:8)	1470	21,2	11	47.600	68	160	1
26098638__FX	HBFX 90 T4 15kW (A3:8)	1465	28,7	15	52.600	67	188	1
26014634__FX	HBFX 100 T4 5,5kW (A3:4)	1450	10,58	5,50	45.600	72	123	1
26015634__FX	HBFX 100 T4 7,5kW (A3:4)	1453	14,46	7,50	51.400	71	137	1
26015638__FX	HBFX 100 T4 7,5kW (A3:8)	1453	14,46	7,50	39.400	81	140	1
26016634__FX	HBFX 100 T4 11kW (A3:4)	1470	21,2	11	62.300	70	164	1
26016638__FX	HBFX 100 T4 11kW (A3:8)	1470	21,2	11	52.500	80	167	1
26017634__FX	HBFX 100 T4 15kW (A3:4)	1465	28,7	15	65.200	71	192	1
26017638__FX	HBFX 100 T4 15kW (A3:8)	1465	28,7	15	63.600	75	195	1
26018638__FX	HBFX 100 T4 18,5kW (A3:8)	1465	35,1	18,50	71.300	73	243	1
26019638__FX	HBFX 100 T4 22kW (A3:8)	1465	40,5	22	75.100	74	244	1
26023634__FX	HBFX 112 T4 5,5kW (A3:4)	1450	10,58	5,50	50.600	75	150	1

Code	Model	R.P.M.	Rated I. (A) 400V	Rated power kW	Max. Airflow m3/h	Sound db (A)**	Weight	Connect. diagram
26024634__FX	HBFX 112 T4 7,5kW (A3:4)	1453	14,46	7,50	59.100	76	156	1
26025634__FX	HBFX 112 T4 11kW (A3:4)	1470	21,2	11	75.500	74	180	1
26025638__FX	HBFX 112 T4 11kW (A3:8)	1470	21,2	11	57.600	83	183	1
26026634__FX	HBFX 112 T4 15kW (A3:4)	1465	28,7	15	86.200	72	205	1
26026638__FX	HBFX 112 T4 15kW (A3:8)	1465	28,7	15	72.400	80	209	1
26027634__FX	HBFX 112 T4 18,5kW (A3:4)	1465	35,1	18,50	89.500	73	248	1
26027638__FX	HBFX 112 T4 18,5kW (A3:8)	1465	35,1	18,50	82.400	78	252	1
26028638__FX	HBFX 112 T4 22kW (A3:8)	1465	40,5	22	91.800	75	253	1
26029638__FX	HBFX 112 T4 30kW (A3:8)	1470	56,2	30	99.700	75	307	1
27006634__FX	HBFX 125 T4 11kW (A3:4)	1470	21,2	11	74.100	83	184	1
27007634__FX	HBFX 125 T4 15kW (A3:4)	1465	28,7	15	91.200	81	212	1
27008634__FX	HBFX 125 T4 18,5kW (A3:4)	1465	35,1	18,50	102.000	76	260	1
27008638__FX	HBFX 125 T4 18,5kW (A3:8)	1465	35,1	18,50	77.800	89	268	1
27009634__FX	HBFX 125 T4 22kW (A3:4)	1465	40,5	22	112.000	75	261	1
27009638__FX	HBFX 125 T4 22kW (A3:8)	1465	40,5	22	91.200	87	269	1
27010634__FX	HBFX 125 T4 30kW (A3:4)	1470	56,2	30	121.000	76	321	1
27010638__FX	HBFX 125 T4 30kW (A3:8)	1470	56,2	30	111.000	84	329	1
27011638__FX	HBFX 125 T4 37kW (A3:8)	1475	66,6	37	124.000	79	430	1
27012638__FX	HBFX 125 T4 45kW (A3:8)	1475	80,7	45	135.000	78	475	1

### Three-phase motor / 6 poles

Code	Model	R.P.M.	Rated I. (A) 400V	Rated power kW	Max. Airflow m3/h	Sound db (A)**	Weight	Connect. diagram
26051606__FX	HBFX 50 T6 0,75kW (A5:6)	923	1,95	0,75	6.000	43	27	1
26058656__FX	HBFX 56 T6 0,75kW (A5:6)	923	1,95	0,75	8.330	48	57	1
26064656__FX	HBFX 63 T6 0,75kW (A5:6)	923	1,95	0,75	11.450	50	52	1
26072656__FX	HBFX 71 T6 0,75kW (A5:6)	923	1,95	0,75	15.440	57	60	1
26080656__FX	HBFX 80 T6 0,75kW (A5:6)	923	1,95	0,75	17.380	59	66	1
26081656__FX	HBFX 80 T6 1,1kW (A5:6)	920	2,78	1,10	19.520	57	70	1
26082656__FX	HBFX 80 T6 1,5kW (A5:6)	933	3,71	1,50	21.820	56	76	1
26083656__FX	HBFX 80 T6 2,2kW (A5:6)	948	5,3	2,20	23.930	56	85	1
26091634__FX	HBFX 90 T6 1,5kW (A3:4)	933	3,71	1,50	25.600	57	85	1
26091638__FX	HBFX 90 T6 1,5kW (A3:8)	933	3,71	1,50	20.700	62	89	1
26092634__FX	HBFX 90 T6 2,2kW (A3:4)	948	5,3	2,20	30.000	56	94	1
26092638__FX	HBFX 90 T6 2,2kW (A3:8)	948	5,3	2,20	25.700	60	97	1
26093638__FX	HBFX 90 T6 3kW (A3:8)	965	7,3	3	30.800	58	121	1
26094638__FX	HBFX 90 T6 4kW (A3:8)	963	9,46	4	34.100	58	127	1

Code	Model	R.P.M.	Rated I. (A) 400V	Rated power kW	Max. Airflow m3/h	Sound db (A)**	Weight	Connect. diagram
26010634__FX	HBFX 100 T6 1,5kW (A3:4)	933	3,71	1,50	29.600	63	92	1
26011634__FX	HBFX 100 T6 2,2kW (A3:4)	948	5,3	2,20	35.000	63	101	1
26011638__FX	HBFX 100 T6 2,2kW (A3:8)	948	5,3	2,20	27.600	71	103	1
26012634__FX	HBFX 100 T6 3kW (A3:4)	965	7,3	3	40.400	61	125	1
26012638__FX	HBFX 100 T6 3kW (A3:8)	965	7,3	3	34.000	68	129	1
26013634__FX	HBFX 100 T6 4kW (A3:4)	963	9,46	4	42.200	61	131	1
26013638__FX	HBFX 100 T6 4kW (A3:8)	963	9,46	4	41.200	66	135	1
26014638__FX	HBFX 100 T6 5,5kW (A3:8)	960	12,8	5,50	48.600	64	139	1
26020634__FX	HBFX 112 T6 2,2kW (A3:4)	948	5,3	2,20	41.000	66	127	1
26021634__FX	HBFX 112 T6 3kW (A3:4)	965	7,3	3	48.900	64	148	1
26021638__FX	HBFX 112 T6 3kW (A3:8)	965	7,3	3	37.300	73	150	1
26022634__FX	HBFX 112 T6 4kW (A3:4)	963	9,46	4	55.900	63	154	1
26022638__FX	HBFX 112 T6 4kW (A3:8)	963	9,46	4	46.900	70	154	1
26023634__FX	HBFX 112 T6 5,5kW (A3:4)	960	12,8	5,50	58.000	63	157	1
26023638__FX	HBFX 112 T6 5,5kW (A3:8)	960	12,8	5,50	56.600	68	164	1
26024638__FX	HBFX 112 T6 7,5kW (A3:8)	970	15	7,50	64.600	66	203	1
27002634__FX	HBFX 125 T6 3kW (A3:4)	965	7,3	3	51.700	73	149	1
27003634__FX	HBFX 125 T6 4kW (A3:4)	963	9,46	4	59.100	70	155	1
27004634__FX	HBFX 125 T6 5,5kW (A3:4)	960	12,8	5,50	69.400	66	159	1
27004638__FX	HBFX 125 T6 5,5kW (A3:8)	960	12,8	5,50	54.800	80	170	1
27005634__FX	HBFX 125 T6 7,5kW (A3:4)	970	15	7,50	78.400	66	203	1
27005638__FX	HBFX 125 T6 7,5kW (A3:8)	970	15	7,50	67.700	76	214	1
27006638__FX	HBFX 125 T6 11kW (A3:8)	970	22	11	83.800	71	234	1
27007638__FX	HBFX 125 T6 15kW (A3:8)	970	27,9	15	87.200	67	272	1

## 2 SPEED MOTOR / 4/8 poles

Code	Model	R.P.M.	Rated I. (A) 400V	Rated power kW	Max. Airflow m3/h	Sound db (A)**	Weight	Connect. diagram
26047606__XW	HBFX 45 T4/T8 0,8/0,2kW (A5:6)	1440	2/0,89	0.8/0.2	6.650	50	22	2
26050606__XW	HBFX 50 T4/T8 0,8/0,2kW (A5:6)	1404	2/0,89	0.8/0.2	8.760	52	30	2
26059656__XW	HBFX 56 T4/T8 0,8/0,2kW (A5:6)	1430	2/0,89	0.8/0.2	10.270	59	57	2
26060656__XW	HBFX 56 T4/T8 1,2/0,3kW (A5:6)	1392	2,92/1,29	1.2/0.3	11.890	56	63	2
26061656__XW	HBFX 56 T4/T8 1,6/0,4kW (A5:6)	1440	3,8/1,69	1.6/0.4	13.870	58	64	2
26065656__XW	HBFX 63 T4/T8 0,8/0,2kW (A5:6)	1430	2/0,89	0.8/0.2	11.420	60	54	2
26066656__XW	HBFX 63 T4/T8 1,2/0,3kW (A5:6)	1410	2,92/1,29	1.2/0.3	14.010	61	59	2
26067656__XW	HBFX 63 T4/T8 1,6/0,4kW (A5:6)	1440	3,8/1,69	1.6/0.4	15.780	59	60	2
26068656__XW	HBFX 63 T4/T8 2,2/0,37kW (A5:6)	1440	4,84/2	2.2/0.37	17.690	59	66	2



Code	Model	R.P.M.	Rated I. (A) 400V	Rated power kW	Max. Airflow m3/h	Sound db (A)**	Weight	Connect. diagram
26072656__XW	HBFX 71 T4/T8 0,8/0,2kW (A5:6)	1430	2/0,89	0.8/0.2	12.950	65	64	2
26073656__XW	HBFX 71 T4/T8 1,2/0,3kW (A5:6)	1410	2,92/1,29	1.2/0.3	15.960	64	66	2
26074656__XW	HBFX 71 T4/T8 1,6/0,4kW (A5:6)	1440	3,8/1,69	1.6/0.4	18.960	63	67	2
26075656__XW	HBFX 71 T4/T8 2,2/0,37kW (A5:6)	1440	4,84/2	2.2/0.37	22.040	62	69	2
26076656__XW	HBFX 71 T4/T8 3/0,55kW (A5:6)	1428	7,1/5,1	3/0.55	23.900	65	72	2
26084656__XW	HBFX 80 T4/T8 3/0,55kW (A5:6)	1428	7,1/5,1	3/0.55	29.500	68	80	2
26085656__XW	HBFX 80 T4/T8 4/0,75kW (A5:6)	1430	8,6/2,6	4/0.75	32.300	65	93	2
26093634__XW	HBFX 90 T4/T8 2,8/0,7kW (A3:4)	1440	6/2,4	2.8/0.7	27.600	67	95	2
26094634__XW	HBFX 90 T4/T8 4/0,75kW (A3:4)	1430	8,6/2,6	4/0.75	32.700	65	102	2
26095634__XW	HBFX 90 T4/T8 5,5/1,1kW (A3:4)	1454	10,9/3,32	5.5/1.1	39.500	64	115	2
26095638__XW	HBFX 90 T4/T8 5,5/1,1kW (A3:8)	1454	10,9/3,32	5.5/1.1	29.400	72	119	2
26096634__XW	HBFX 90 T4/T8 7,5/1,5kW (A3:4)	1461	14,9/3,7	7.5/1.5	44.600	65	129	2
26096638__XW	HBFX 90 T4/T8 7,5/1,5kW (A3:8)	1461	14,9/3,7	7.5/1.5	37.100	70	133	2
26097634__XW	HBFX 90 T4/T8 11/3kW (A3:4)	1455	21,7/7	11/3	46.300	65	159	2
26097638__XW	HBFX 90 T4/T8 11/3kW (A3:8)	1455	21,7/7	11/3	47.600	68	160	2
26098638__XW	HBFX 90 T4/T8 14/3,5kW (A3:8)	1450	26,5/8,45	14/3.5	52.600	67	190	2
26014634__XW	HBFX 100 T4/T8 5,5/1,1kW (A3:4)	1454	10,9/3,32	5.5/1.1	45.600	72	123	2
26015634__XW	HBFX 100 T4/T8 7,5/1,5kW (A3:4)	1461	14,9/3,7	7.5/1.5	51.400	71	137	2
26015638__XW	HBFX 100 T4/T8 7,5/1,5kW (A3:8)	1461	14,9/3,7	7.5/1.5	39.400	81	140	2
26016634__XW	HBFX 100 T4/T8 11/3kW (A3:4)	1455	21,7/7	11/3	62.300	70	164	2
26016638__XW	HBFX 100 T4/T8 11/3kW (A3:8)	1455	21,7/7	11/3	52.500	80	167	2
26017634__XW	HBFX 100 T4/T8 14/3,5kW (A3:4)	1450	26,5/8,45	14/3.5	65.200	71	170	2
26017638__XW	HBFX 100 T4/T8 14/3,5kW (A3:8)	1450	26,5/8,45	14/3.5	59.700	75	173	2
26018638__XW	HBFX 100 T4/T8 17/4,3kW (A3:8)	1475	33,4/12,7	17/4.3	67.500	73	185	2
26019638__XW	HBFX 100 T4/T8 20/5kW (A3:8)	1470	38,6/14,1	20/5	75.100	74	195	2
26023634__XW	HBFX 112 T4/T8 5,5/1,1kW (A3:4)	1454	10,9/3,32	5.5/1.1	50.600	75	140	2
26024634__XW	HBFX 112 T4/T8 7,5/1,5kW (A3:4)	1461	14,9/3,7	7.5/1.5	59.100	76	156	2
26025634__XW	HBFX 112 T4/T8 11/3kW (A3:4)	1455	21,7/7	11/3	75.500	74	180	2
26025638__XW	HBFX 112 T4/T8 11/3kW (A3:8)	1455	21,7/7	11/3	52.700	83	183	2
26026634__XW	HBFX 112 T4/T8 14/3,5kW (A3:4)	1450	26,5/8,45	14/3.5	82.900	72	190	2
26026638__XW	HBFX 112 T4/T8 14/3,5kW (A3:8)	1450	26,5/8,45	14/3.5	67.500	81	193	2
26026634__XW	HBFX 112 T4/T8 17/4,3kW (A3:4)	1475	33,4/12,7	17/4.3	89.500	73	185	2
26026638__XW	HBFX 112 T4/T8 17/4,3kW (A3:8)	1475	33,4/12,7	17/4.3	77.400	79	189	2
26028638__XW	HBFX 112 T4/T8 20/5kW (A3:8)	1470	38,6/14,1	20/5	82.400	77	209	2
26028638__XW	HBFX 112 T4/T8 28/6,5kW (A3:8)	1480	52/18	28/6.5	99.700	75	252	2
27006634__XW	HBFX 125 T4/T8 11/3kW (A3:4)	1455	21,7/7	11/3	74.100	83	184	2
27007634__XW	HBFX 125 T4/T8 14/3,5kW (A3:4)	1450	26,5/8,45	14/3.5	85.500	81	184	2
27008634__XW	HBFX 125 T4/T8 17/4,3kW (A3:4)	1475	33,4/12,7	17/4.3	96.900	78	184	2
27009634__XW	HBFX 125 T4/T8 20/5kW (A3:4)	1470	38,6/14,1	20/5	107.000	76	212	2

Code	Model	R.P.M.	Rated I. (A) 400V	Rated power kW	Max. Airflow m3/h	Sound db (A)**	Weight	Connect. diagram
27008638__XW	HBFX 125 T4/T8 20/5kW (A3:8)	1470	38,6/14,1	20/5	84.500	89	217	2
27009634__XW	HBFX 125 T4/T8 28/6,5kW (A3:4)	1480	52/18	28/6.5	121.000	76	260	2
27010638__XW	HBFX 125 T4/T8 28/6,5kW (A3:8)	1480	52/18	28/6.5	105.000	85	268	2
27011638__XW	HBFX 125 T4/T8 37/9,2kW (A3:8)	1485	74,2/25,4	37/9.2	124.000	81	280	2
27012638__XW	HBFX 125 T4/T8 44/11kW (A3:8)	1480	80,2/27,2	44/11	135.000	78	475	2

**Notes:**  
 \*\* Total sound pressure level at the point of maximum flow measured in dB(A) in the suction measured in free field at a distance of 6m from the source

## Dimensions

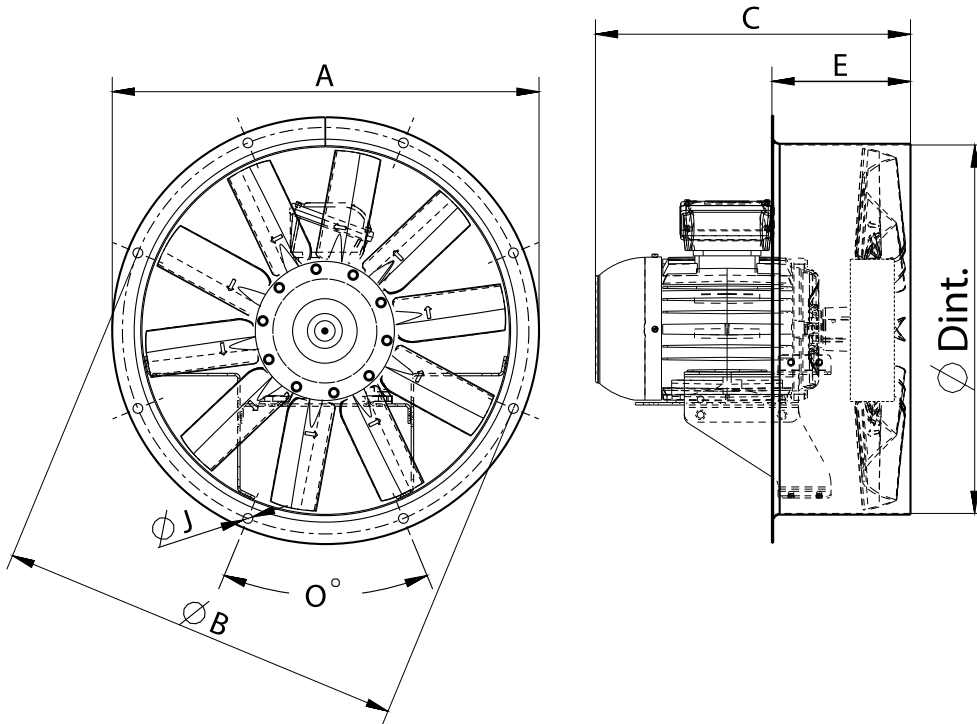

Model	C	E	O	ØA	ØB	ØDint	ØI
HBFX 45 T4 0,75kW (A5:6)	347	165	8x45°	525	500	452	12
HBFX 45 T4/T8 0,8/0,2kW (A5:6)	347	165	8x45°	525	500	452	12
HBFX 50 T4 0,75kW (A5:6)	350	165	12x30°	600	560	504	12
HBFX 50 T6 0,75kW (A5:6)	362	165	12x30°	600	560	504	12
HBFX 50 T4/T8 0,8/0,2kW (A5:6)	350	165	12x30°	600	560	504	12
HBFX 56 T4 0,75kW (A5:6)	352	185	12x30°	646	620	559	12
HBFX 56 T4 1,1kW (A5:6)	362	185	12x30°	646	620	559	12
HBFX 56 T4 1,5kW (A5:6)	387	185	12x30°	646	620	559	12
HBFX 56 T6 0,75kW (A5:6)	362	185	12x30°	646	620	559	12
HBFX 56 T4/T8 0,8/0,2kW (A5:6)	362	185	12x30°	646	620	559	12
HBFX 56 T4/T8 1,2/0,3kW (A5:6)	362	185	12x30°	646	620	559	12
HBFX 56 T4/T8 1,6/0,4kW (A5:6)	387	185	12x30°	646	620	559	12
HBFX 63 T4 0,75kW (A5:6)	352	185	12x30°	725	690	633	12
HBFX 63 T4 1,1kW (A5:6)	386	185	12x30°	725	690	633	12
HBFX 63 T4 1,5kW (A5:6)	411	185	12x30°	725	690	633	12
HBFX 63 T4 2,2kW (A5:6)	627	185	12x30°	725	690	633	12
HBFX 63 T6 0,75kW (A5:6)	386	185	12x30°	725	690	633	12
HBFX 63 T4/T8 0,8/0,2kW (A5:6)	352	185	12x30°	725	690	633	12
HBFX 63 T4/T8 1,2/0,3kW (A5:6)	386	185	12x30°	725	690	633	12

Model	C	E	O	ØA	ØB	ØDint	ØI
HBFX 63 T4/T8 1,6/0,4kW (A5:6)	411	185	12x30°	725	690	633	12
HBFX 63 T4/T8 2,2/0,37kW (A5:6)	627	185	12x30°	725	690	633	12
HBFX 71 T4 0,75kW (A5:6)	357	190	16x22,5°	802	770	715	12
HBFX 71 T4 1,1kW (A5:6)	391	190	16x22,5°	802	770	715	12
HBFX 71 T4 1,5kW (A5:6)	416	190	16x22,5°	802	770	715	12
HBFX 71 T4 2,2kW (A5:6)	447	190	16x22,5°	802	770	715	12
HBFX 71 T4 3kW (A5:6)	447	190	16x22,5°	802	770	715	12
HBFX 71 T6 0,75kW (A5:6)	391	190	16x22,5°	802	770	715	12
HBFX 71 T4/T8 0,8/0,2kW (A5:6)	357	190	16x22,5°	802	770	715	12
HBFX 71 T4/T8 1,2/0,3kW (A5:6)	391	190	16x22,5°	802	770	715	12
HBFX 71 T4/T8 1,6/0,4kW (A5:6)	416	190	16x22,5°	802	770	715	12
HBFX 71 T4/T8 2,2/0,37kW (A5:6)	447	190	16x22,5°	802	770	715	12
HBFX 71 T4/T8 3/0,55kW (A5:6)	447	190	16x22,5°	802	770	715	12
HBFX 80 T4 3kW (A5:6)	463	220	16x22,5°	892	860	801	12
HBFX 80 T4 4kW (A5:6)	469	220	16x22,5°	892	860	801	12
HBFX 80 T6 0,75kW (A5:6)	427	220	16x22,5°	892	860	801	12
HBFX 80 T6 1,1kW (A5:6)	427	220	16x22,5°	892	860	801	12
HBFX 80 T6 1,5kW (A5:6)	463	220	16x22,5°	892	860	801	12
HBFX 80 T6 2,2kW (A5:6)	469	220	16x22,5°	892	860	801	12
HBFX 80 T4/T8 3/0,55kW (A5:6)	463	220	16x22,5°	892	860	801	12
HBFX 80 T4/T8 4/0,75kW (A5:6)	469	220	16x22,5°	892	860	801	12
HBFX 90 T4 3kW (A3:4)	658	340	16x22,5°	1000	970	903,5	12
HBFX 90 T4 4kW (A3:4)	658	340	16x22,5°	1000	970	903,5	12
HBFX 90 T4 5,5kW (A3:4)	658	340	16x22,5°	1000	970	903,5	12
HBFX 90 T4 5,5kW (A3:8)	658	340	16x22,5°	1000	970	903,5	12
HBFX 90 T4 7,5kW (A3:4)	658	340	16x22,5°	1000	970	903,5	12
HBFX 90 T4 7,5kW (A3:8)	658	340	16x22,5°	1000	970	903,5	12
HBFX 90 T4 11kW (A3:4)	721	340	16x22,5°	1000	970	903,5	12
HBFX 90 T4 11kW (A3:8)	721	340	16x22,5°	1000	970	903,5	12
HBFX 90 T4 15kW (A3:8)	742	340	16x22,5°	1000	970	903,5	12
HBFX 90 T6 1,5kW (A3:4)	658	340	16x22,5°	1000	970	903,5	12
HBFX 90 T6 1,5kW (A3:8)	658	340	16x22,5°	1000	970	903,5	12
HBFX 90 T6 2,2kW (A3:4)	658	340	16x22,5°	1000	970	903,5	12
HBFX 90 T6 2,2kW (A3:8)	658	340	16x22,5°	1000	970	903,5	12
HBFX 90 T6 3kW (A3:8)	658	340	16x22,5°	1000	970	903,5	12
HBFX 90 T6 4kW (A3:8)	658	340	16x22,5°	1000	970	903,5	12
HBFX 90 T4/T8 2,8/0,7kW (A3:4)	658	340	16x22,5°	1000	970	903,5	12
HBFX 90 T4/T8 4/0,75kW (A3:4)	658	340	16x22,5°	1000	970	903,5	12
HBFX 90 T4/T8 5,5/1,1kW (A3:4)	658	340	16x22,5°	1000	970	903,5	12
HBFX 90 T4/T8 5,5/1,1kW (A3:8)	658	340	16x22,5°	1000	970	903,5	12



Model	C	E	O	ØA	ØB	ØDint	ØI
HBFX 90 T4/T8 7,5/1,5kW (A3:4)	658	340	16x22,5°	1000	970	903,5	12
HBFX 90 T4/T8 7,5/1,5kW (A3:8)	658	340	16x22,5°	1000	970	903,5	12
HBFX 90 T4/T8 11/3kW (A3:4)	721	340	16x22,5°	1000	970	903,5	12
HBFX 90 T4/T8 11/3kW (A3:8)	721	340	16x22,5°	1000	970	903,5	12
HBFX 90 T4/T8 14/3,5kW (A3:8)	742	340	16x22,5°	1000	970	903,5	12
HBFX 100 T4 5,5kW (A3:4)	653	340	16x22,5°	1115	1070	1013	12
HBFX 100 T4 7,5kW (A3:4)	653	340	16x22,5°	1115	1070	1013	12
HBFX 100 T4 7,5kW (A3:8)	653	340	16x22,5°	1115	1070	1013	12
HBFX 100 T4 11kW (A3:4)	716	340	16x22,5°	1115	1070	1013	12
HBFX 100 T4 11kW (A3:8)	716	340	16x22,5°	1115	1070	1013	12
HBFX 100 T4 15kW (A3:4)	738	340	16x22,5°	1115	1070	1013	12
HBFX 100 T4 15kW (A3:8)	738	340	16x22,5°	1115	1070	1013	12
HBFX 100 T4 18,5kW (A3:8)	776	340	16x22,5°	1115	1070	1013	12
HBFX 100 T4 22kW (A3:8)	792	340	16x22,5°	1115	1070	1013	12
HBFX 100 T6 1,5kW (A3:4)	653	340	16x22,5°	1115	1070	1013	12
HBFX 100 T6 2,2kW (A3:4)	653	340	16x22,5°	1115	1070	1013	12
HBFX 100 T6 2,2kW (A3:8)	653	340	16x22,5°	1115	1070	1013	12
HBFX 100 T6 3kW (A3:4)	653	340	16x22,5°	1115	1070	1013	12
HBFX 100 T6 3kW (A3:8)	653	340	16x22,5°	1115	1070	1013	12
HBFX 100 T6 4kW (A3:4)	653	340	16x22,5°	1115	1070	1013	12
HBFX 100 T6 4kW (A3:8)	653	340	16x22,5°	1115	1070	1013	12
HBFX 100 T6 5,5kW (A3:8)	653	340	16x22,5°	1115	1070	1013	12
HBFX 100 T4/T8 5,5/1,1kW (A3:4)	653	340	16x22,5°	1115	1070	1013	12
HBFX 100 T4/T8 7,5/1,5kW (A3:4)	653	340	16x22,5°	1115	1070	1013	12
HBFX 100 T4/T8 7,5/1,5kW (A3:8)	653	340	16x22,5°	1115	1070	1013	12
HBFX 100 T4/T8 11/3kW (A3:4)	716	340	16x22,5°	1115	1070	1013	12
HBFX 100 T4/T8 11/3kW (A3:8)	716	340	16x22,5°	1115	1070	1013	12
HBFX 100 T4/T8 14/3,5kW (A3:4)	738	340	16x22,5°	1115	1070	1013	12
HBFX 100 T4/T8 14/3,5kW (A3:8)	738	340	16x22,5°	1115	1070	1013	12
HBFX 100 T4/T8 17/4,3kW (A3:8)	776	340	16x22,5°	1115	1070	1013	12
HBFX 100 T4/T8 20/5kW (A3:8)	792	340	16x22,5°	1115	1070	1013	12
HBFX 112 T4 5,5kW (A3:4)	760	340	16x22,5°	1234	1190	1132	12
HBFX 112 T4 7,5kW (A3:4)	760	340	16x22,5°	1234	1190	1132	12
HBFX 112 T4 11kW (A3:4)	760	340	16x22,5°	1234	1190	1132	12
HBFX 112 T4 11kW (A3:8)	760	340	16x22,5°	1234	1190	1132	12
HBFX 112 T4 15kW (A3:4)	760	340	16x22,5°	1234	1190	1132	12
HBFX 112 T4 15kW (A3:8)	760	340	16x22,5°	1234	1190	1132	12
HBFX 112 T4 18,5kW (A3:4)	761	340	16x22,5°	1234	1190	1132	12
HBFX 112 T4 18,5kW (A3:8)	761	340	16x22,5°	1234	1190	1132	12
HBFX 112 T4 22kW (A3:8)	780	340	16x22,5°	1234	1190	1132	12

Model	C	E	O	ØA	ØB	ØDint	ØI
HBFX 112 T4 30kW (A3:8)	864	340	16x22,5°	1234	1190	1132	12
HBFX 112 T6 2,2kW (A3:4)	760	340	16x22,5°	1234	1190	1132	12
HBFX 112 T6 3kW (A3:4)	760	340	16x22,5°	1234	1190	1132	12
HBFX 112 T6 3kW (A3:8)	760	340	16x22,5°	1234	1190	1132	12
HBFX 112 T6 4kW (A3:4)	760	340	16x22,5°	1234	1190	1132	12
HBFX 112 T6 4kW (A3:8)	760	340	16x22,5°	1234	1190	1132	12
HBFX 112 T6 5,5kW (A3:4)	760	340	16x22,5°	1234	1190	1132	12
HBFX 112 T6 5,5kW (A3:8)	760	340	16x22,5°	1234	1190	1132	12
HBFX 112 T6 7,5kW (A3:8)	760	340	16x22,5°	1234	1190	1132	12
HBFX 112 T4/T8 5,5/1,1kW (A3:4)	760	340	16x22,5°	1234	1190	1132	12
HBFX 112 T4/T8 7,5/1,5kW (A3:4)	760	340	16x22,5°	1234	1190	1132	12
HBFX 112 T4/T8 11/3kW (A3:4)	760	340	16x22,5°	1234	1190	1132	12
HBFX 112 T4/T8 11/3kW (A3:8)	760	340	16x22,5°	1234	1190	1132	12
HBFX 112 T4/T8 14/3,5kW (A3:4)	760	340	16x22,5°	1234	1190	1132	12
HBFX 112 T4/T8 14/3,5kW (A3:8)	760	340	16x22,5°	1234	1190	1132	12
HBFX 112 T4/T8 17/4,3kW (A3:4)	761	340	16x22,5°	1234	1190	1132	12
HBFX 112 T4/T8 17/4,3kW (A3:8)	761	340	16x22,5°	1234	1190	1132	12
HBFX 112 T4/T8 20/5kW (A3:8)	780	340	16x22,5°	1234	1190	1132	12
HBFX 112 T4/T8 28/6,5kW (A3:8)	864	340	16x22,5°	1234	1190	1132	12
HBFX 125 T4 11kW (A3:4)	759	340	20x18°	1365	1320	1263	15
HBFX 125 T4 15kW (A3:4)	759	340	20x18°	1365	1320	1263	15
HBFX 125 T4 18,5kW (A3:4)	760	340	20x18°	1365	1320	1263	15
HBFX 125 T4 18,5kW (A3:8)	760	340	20x18°	1365	1320	1263	15
HBFX 125 T4 22kW (A3:4)	779	340	20x18°	1365	1320	1263	15
HBFX 125 T4 22kW (A3:8)	779	340	20x18°	1365	1320	1263	15
HBFX 125 T4 30kW (A3:4)	863	340	20x18°	1365	1320	1263	15
HBFX 125 T4 30kW (A3:8)	863	340	20x18°	1365	1320	1263	15
HBFX 125 T4 37kW (A3:8)	948	340	20x18°	1365	1320	1263	15
HBFX 125 T4 45kW (A3:8)	948	340	20x18°	1365	1320	1263	15
HBFX 125 T6 3kW (A3:4)	759	340	20x18°	1365	1320	1263	15
HBFX 125 T6 4kW (A3:4)	759	340	20x18°	1365	1320	1263	15
HBFX 125 T6 5,5kW (A3:4)	759	340	20x18°	1365	1320	1263	15
HBFX 125 T6 5,5kW (A3:8)	759	340	20x18°	1365	1320	1263	15
HBFX 125 T6 7,5kW (A3:4)	759	340	20x18°	1365	1320	1263	15
HBFX 125 T6 7,5kW (A3:8)	759	340	20x18°	1365	1320	1263	15
HBFX 125 T6 11kW (A3:8)	759	340	20x18°	1365	1320	1263	15
HBFX 125 T6 15kW (A3:8)	779	340	20x18°	1365	1320	1263	15
HBFX 125 T4/T8 11/3kW (A3:4)	759	340	20x18°	1365	1320	1263	15
HBFX 125 T4/T8 14/3,5kW (A3:4)	759	340	20x18°	1365	1320	1263	15
HBFX 125 T4/T8 17/4,3kW (A3:4)	760	340	20x18°	1365	1320	1263	15

Model	C	E	O	ØA	ØB	ØDint	ØI
HBFX 125 T4/T8 20/5kW (A3:4)	779	340	20x18°	1365	1320	1263	15
HBFX 125 T4/T8 20/5kW (A3:8)	779	340	20x18°	1365	1320	1263	15
HBFX 125 T4/T8 28/6,5kW (A3:4)	863	340	20x18°	1365	1320	1263	15
HBFX 125 T4/T8 28/6,5kW (A3:8)	863	340	20x18°	1365	1320	1263	15
HBFX 125 T4/T8 37/9,2kW (A3:8)	948	340	20X18°	1365	1320	1263	15
HBFX 125 T4/T8 44/11kW (A3:8)	948	340	20x18°	1365	1320	1263	15

## Wiring diagram

DIAGRAM Nº 1

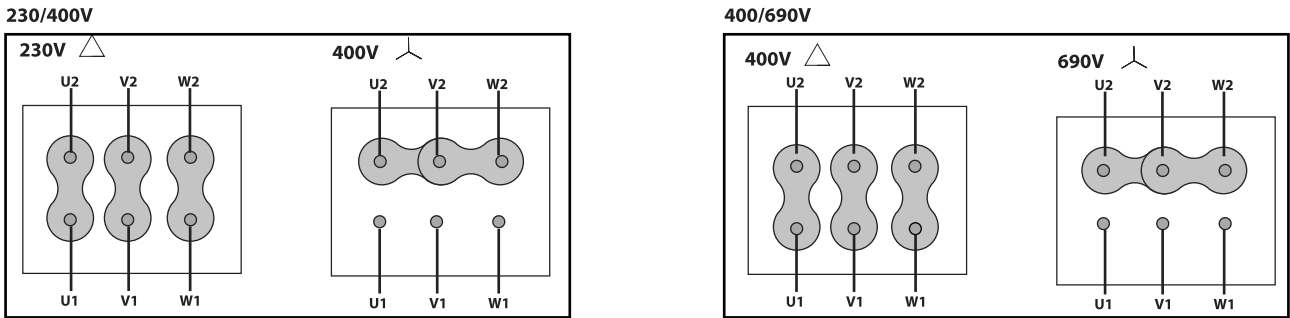
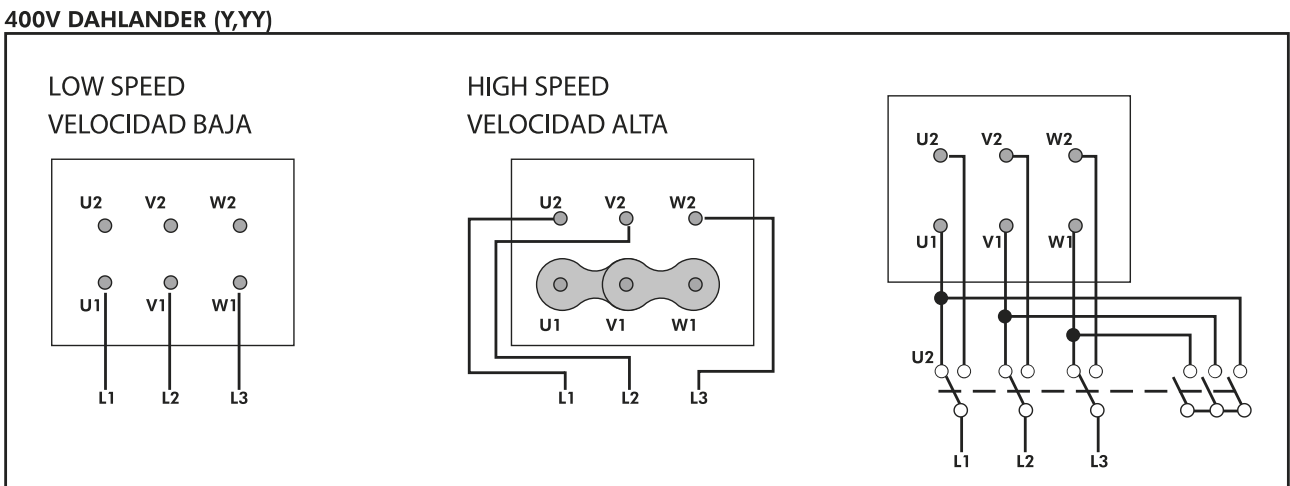

DIAGRAM Nº 2



# CHARACTERISCTIC CURVE

HBFX 45 T4 0,75kW (A5:6)

## AIR FLOW - PRESSURE

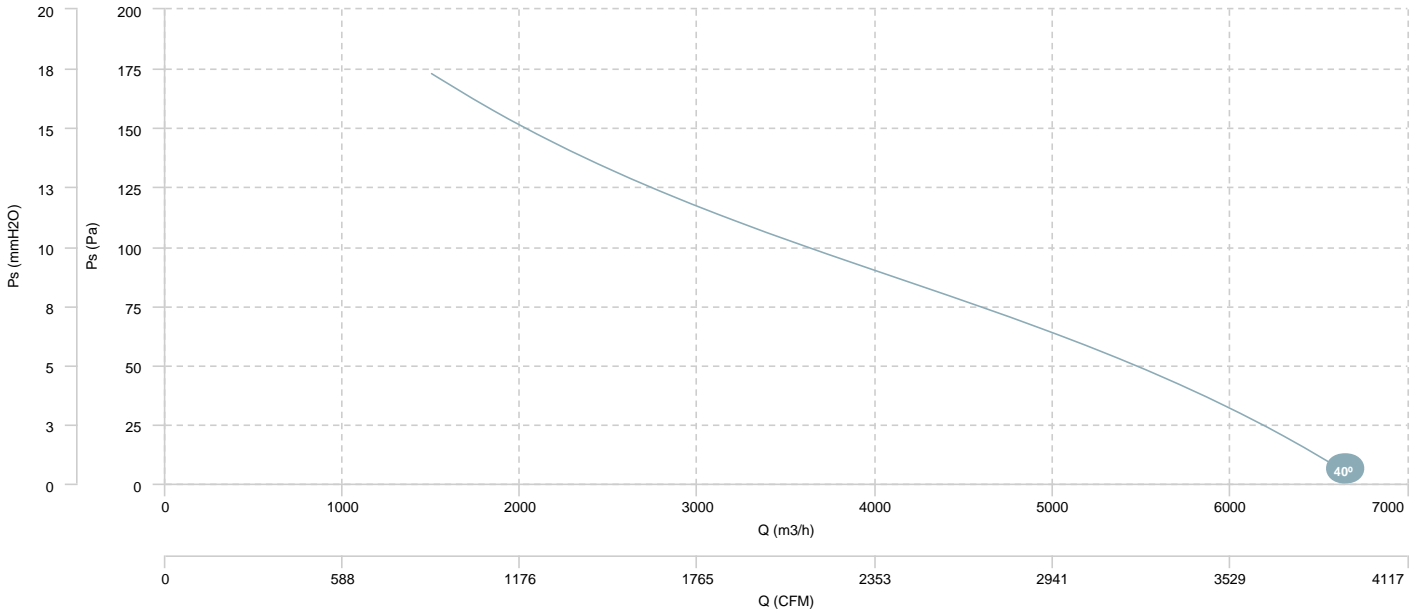

## AIR FLOW - ABSORBED POWER

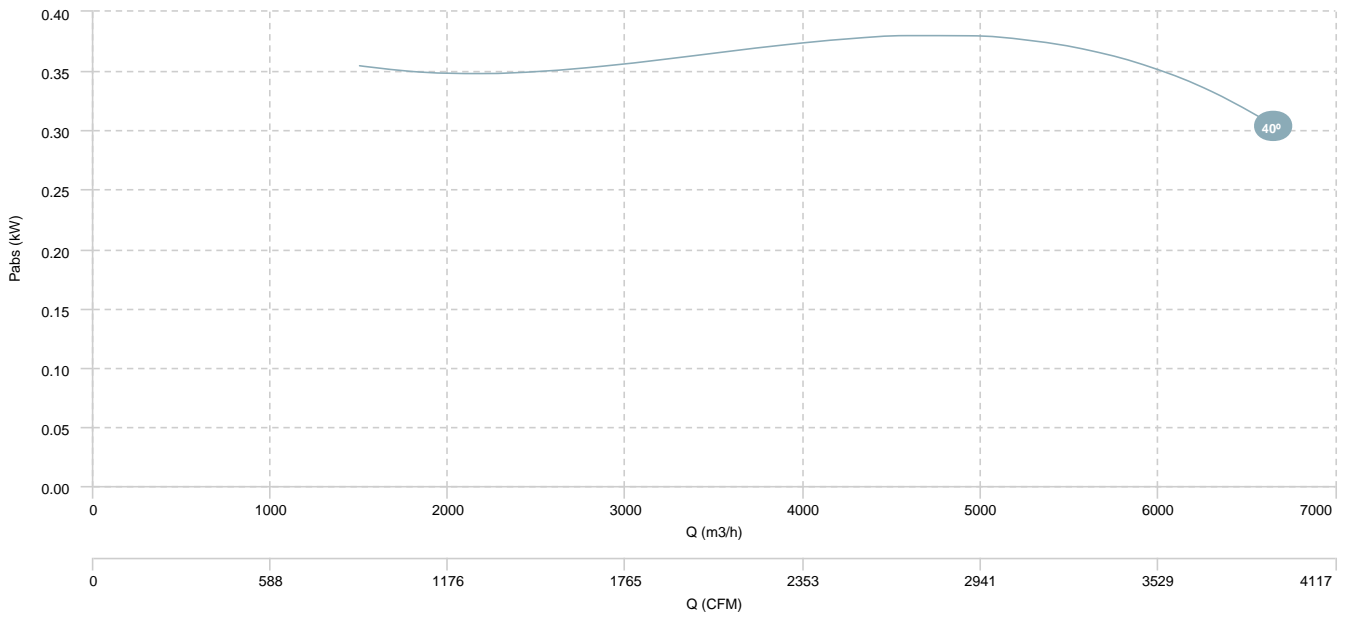

HBFX 45 T4/T8 0,8/0,2kW (A5:6)

AIR FLOW - PRESSURE (4 poles)

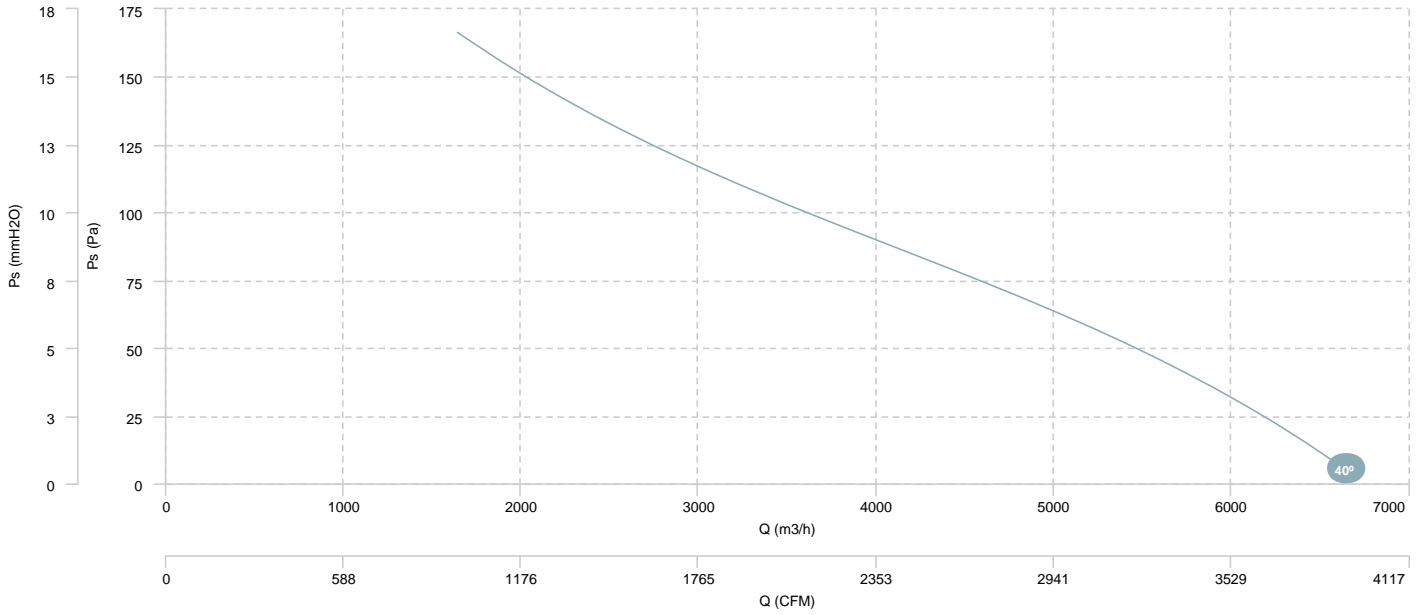

AIR FLOW - ABSORBED POWER (4 poles)

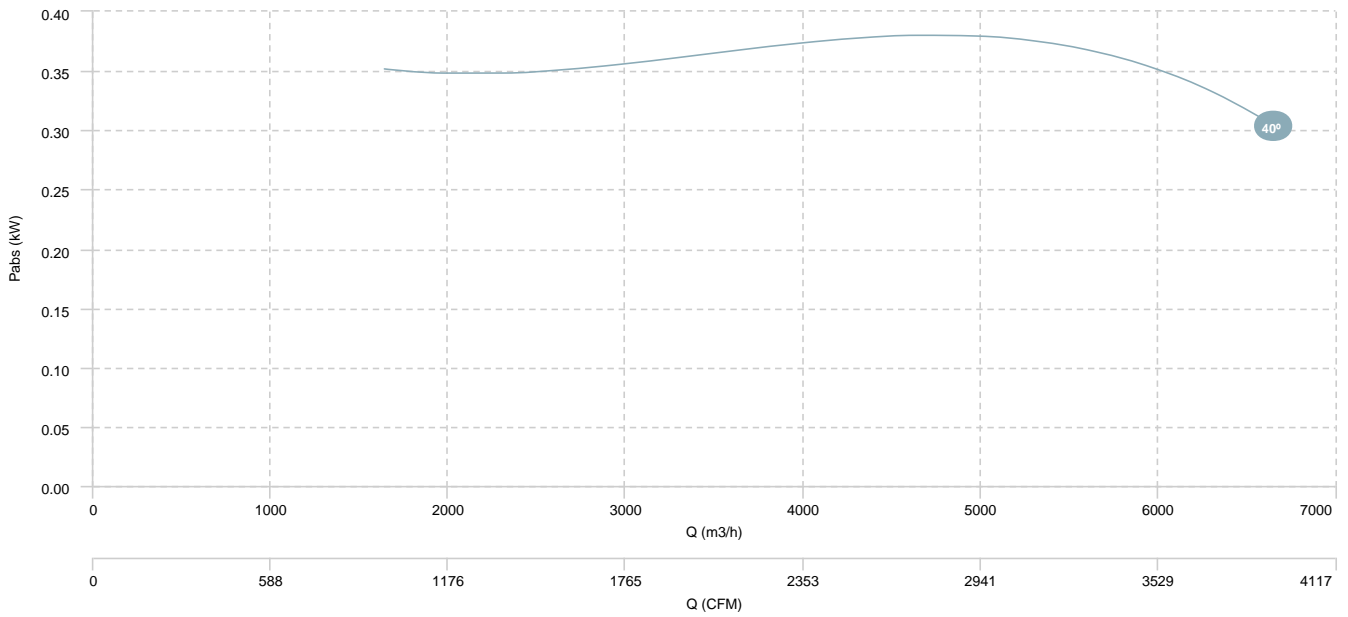

HBFX 45 T4/T8 0,8/0,2kW (A5:6)

AIR FLOW - PRESSURE (8 poles)

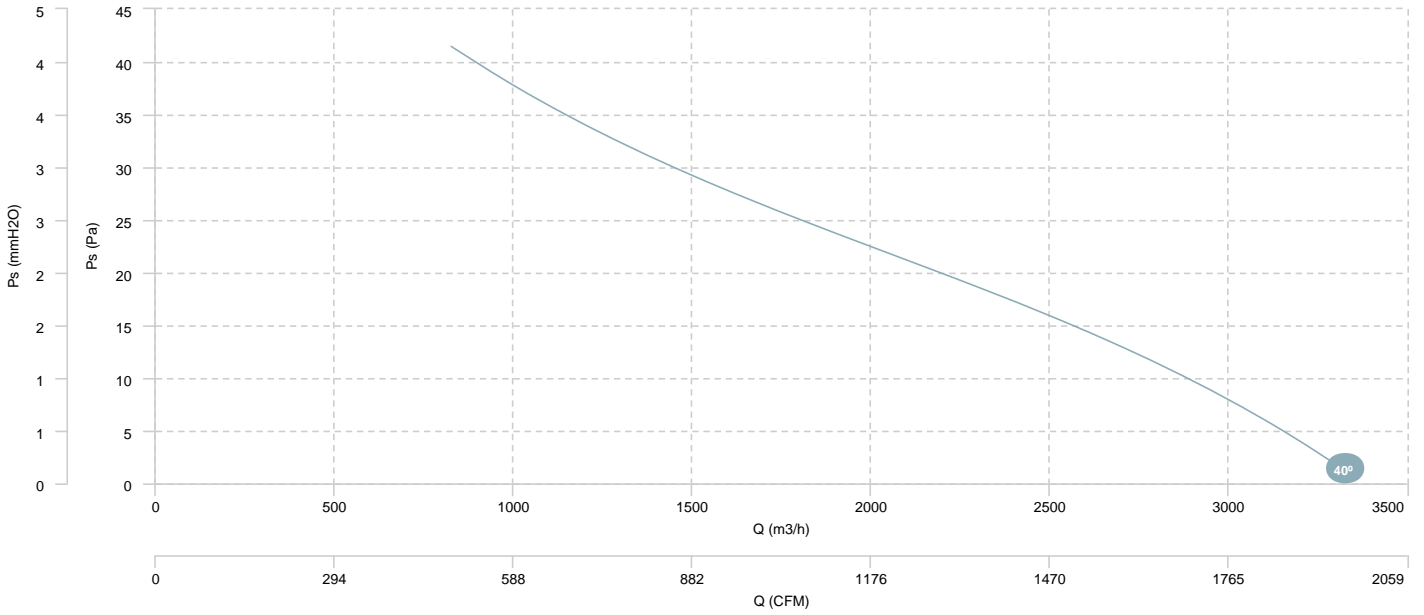

HBFX 50 T4 0,75kW (A5:6)

AIR FLOW - PRESSURE

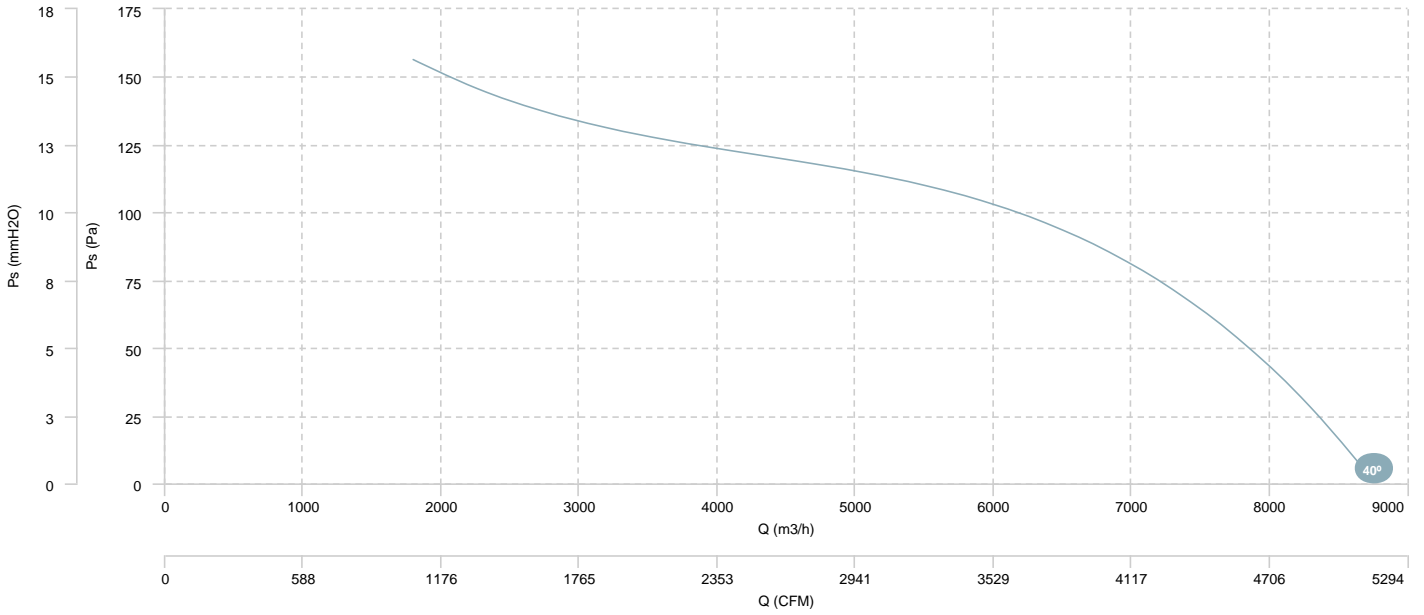

AIR FLOW - ABSORBED POWER

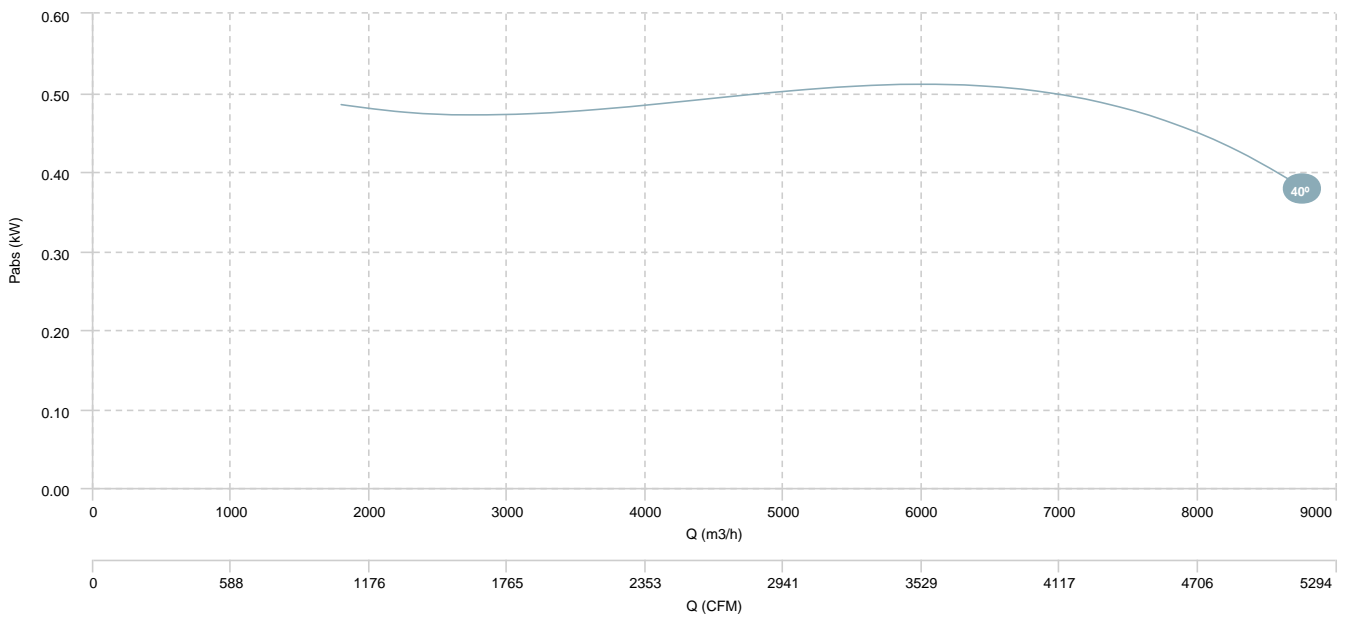



HBFX 50 T6 0,75kW (A5:6)

AIR FLOW - PRESSURE

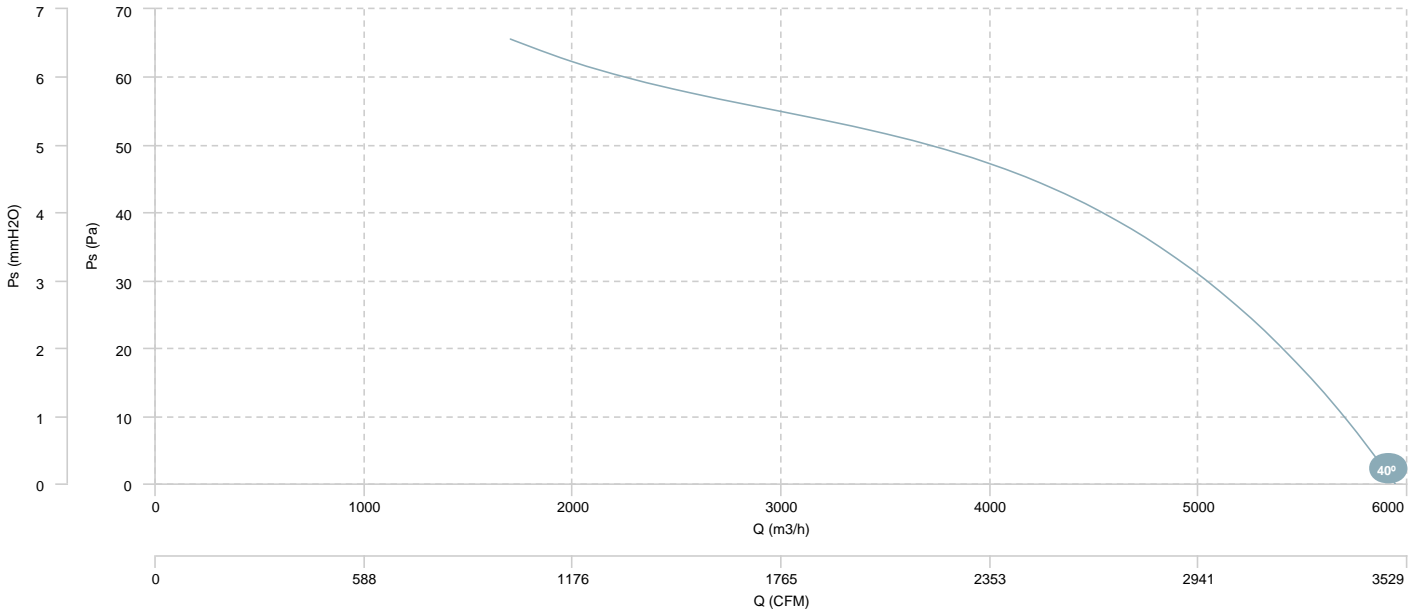

AIR FLOW - ABSORBED POWER

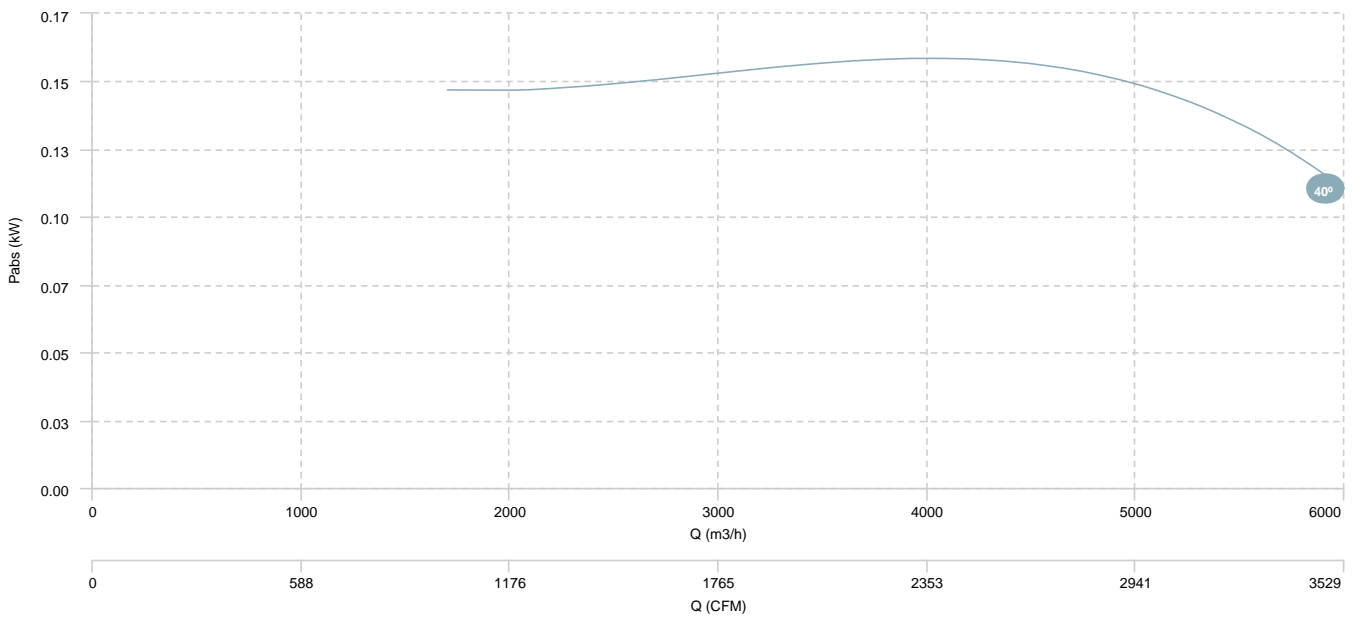

HBFX 50 T4/T8 0,8/0,2kW (A5:6)

AIR FLOW - PRESSURE (4 poles)

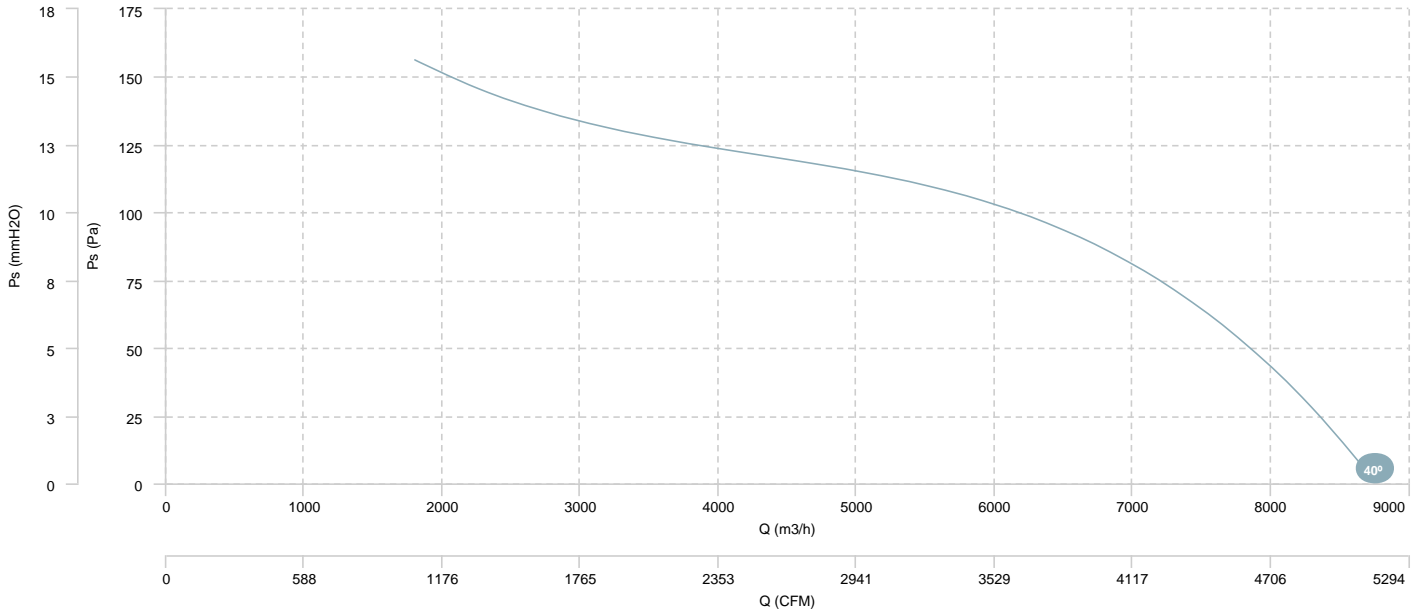

AIR FLOW - ABSORBED POWER (4 poles)

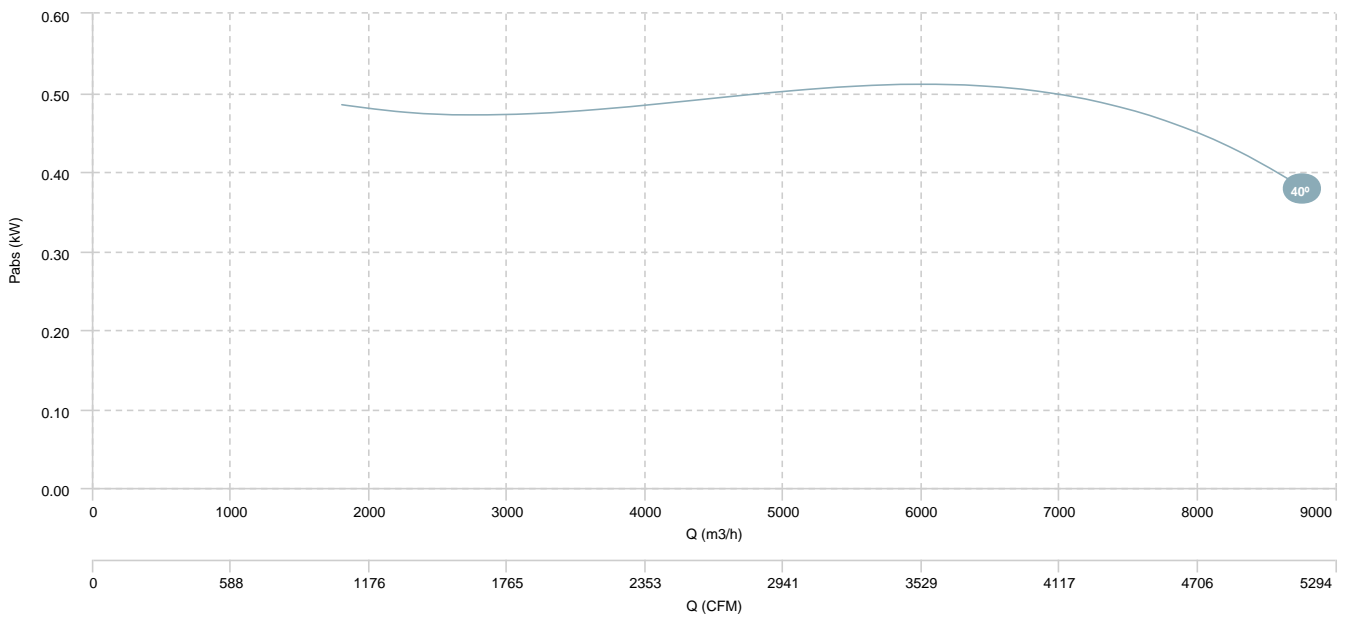

HBFX 50 T4/T8 0,8/0,2kW (A5:6)

AIR FLOW - PRESSURE (8 poles)

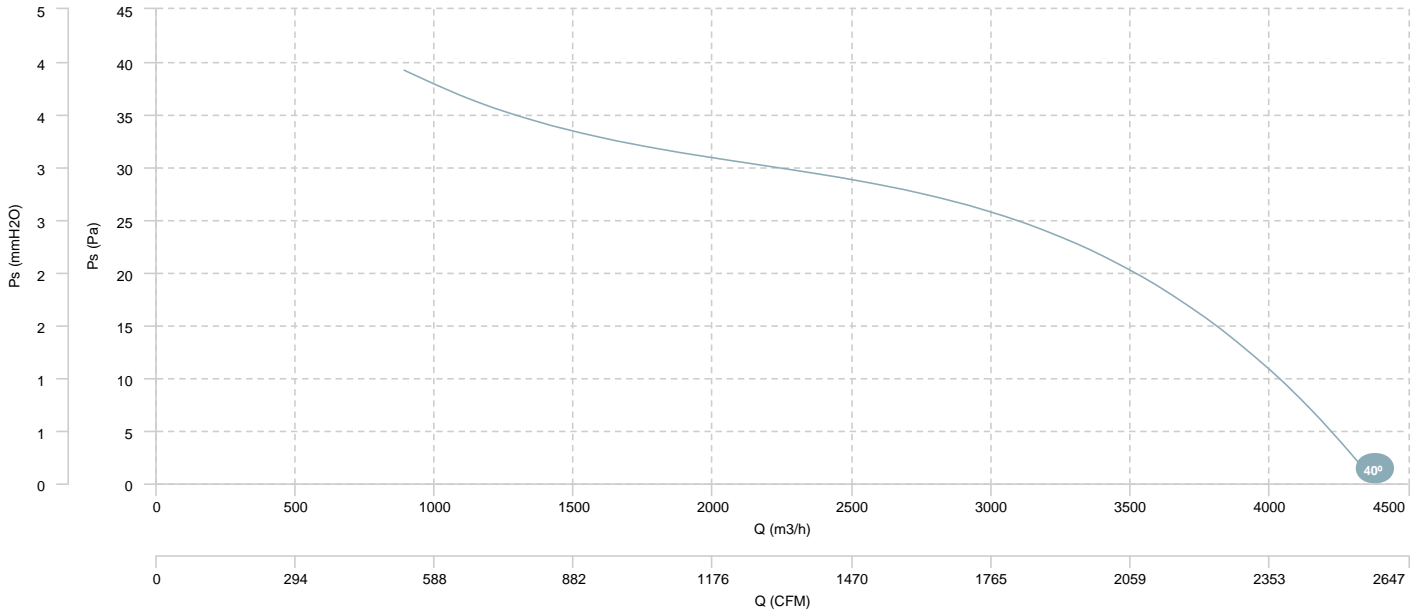

HBFX 56 T4 0,75kW (A5:6)

HBFX 56 T4 1,1kW (A5:6)

HBFX 56 T4 1,5kW (A5:6)

AIR FLOW - PRESSURE

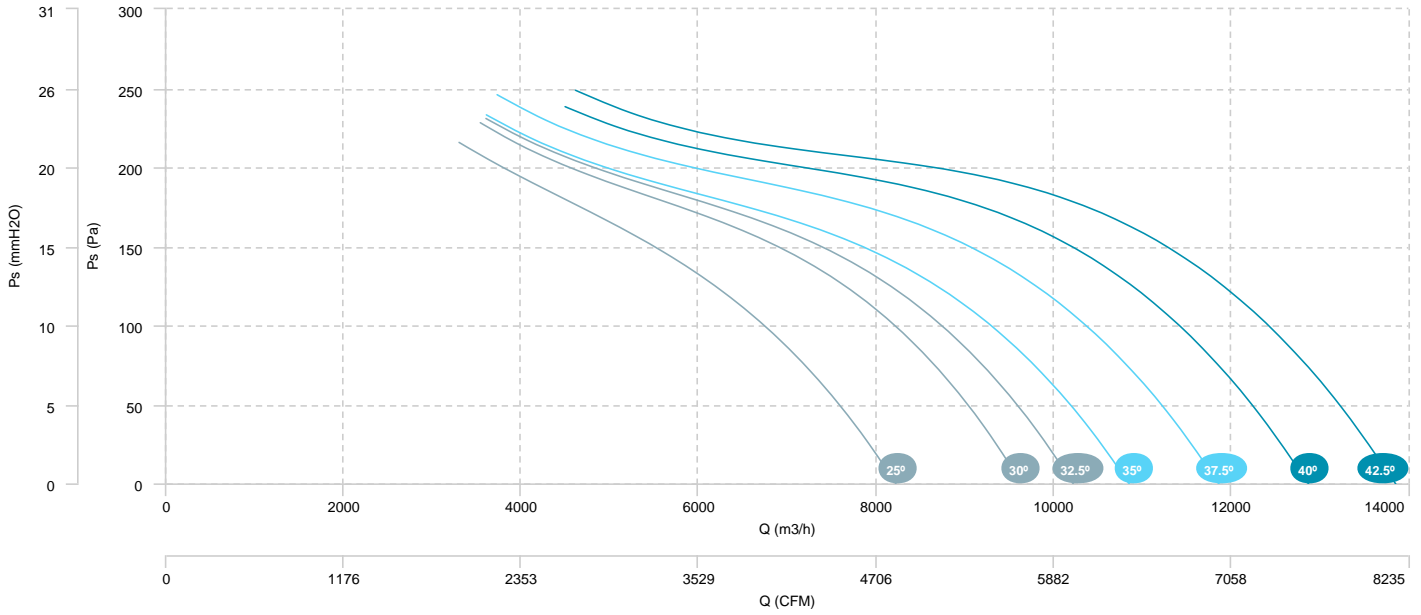

AIR FLOW - ABSORBED POWER

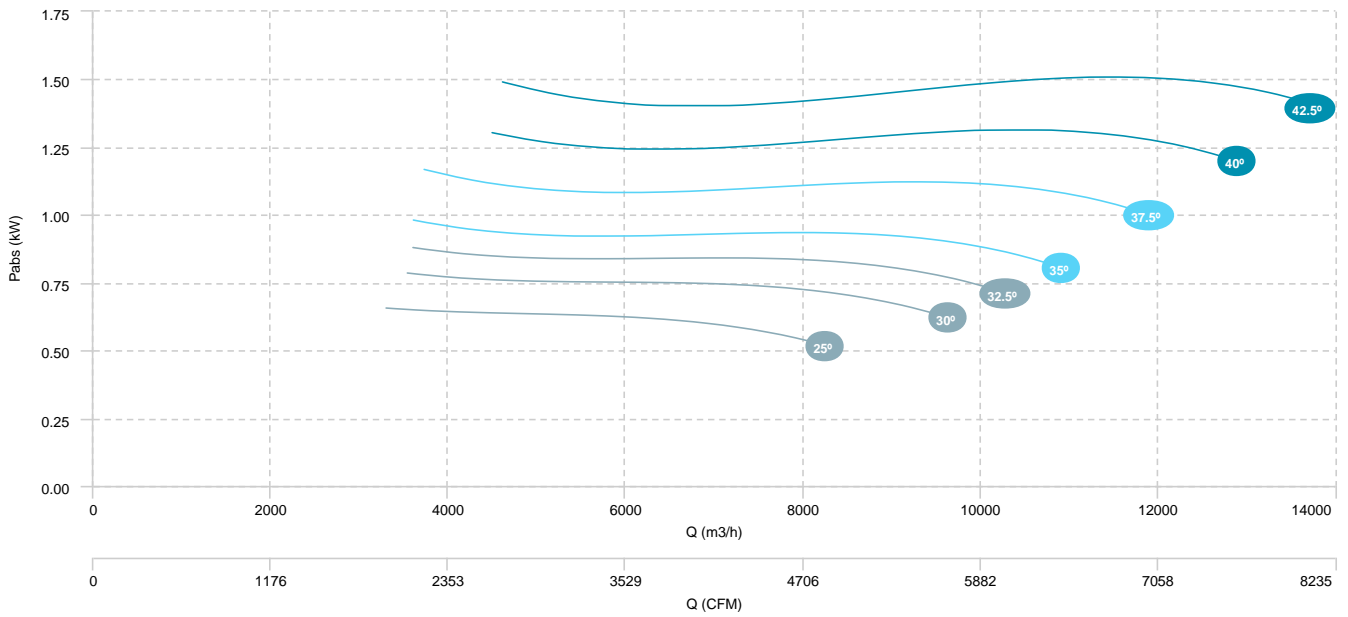

HBFX 56 T6 0,75kW (A5:6)

AIR FLOW - PRESSURE

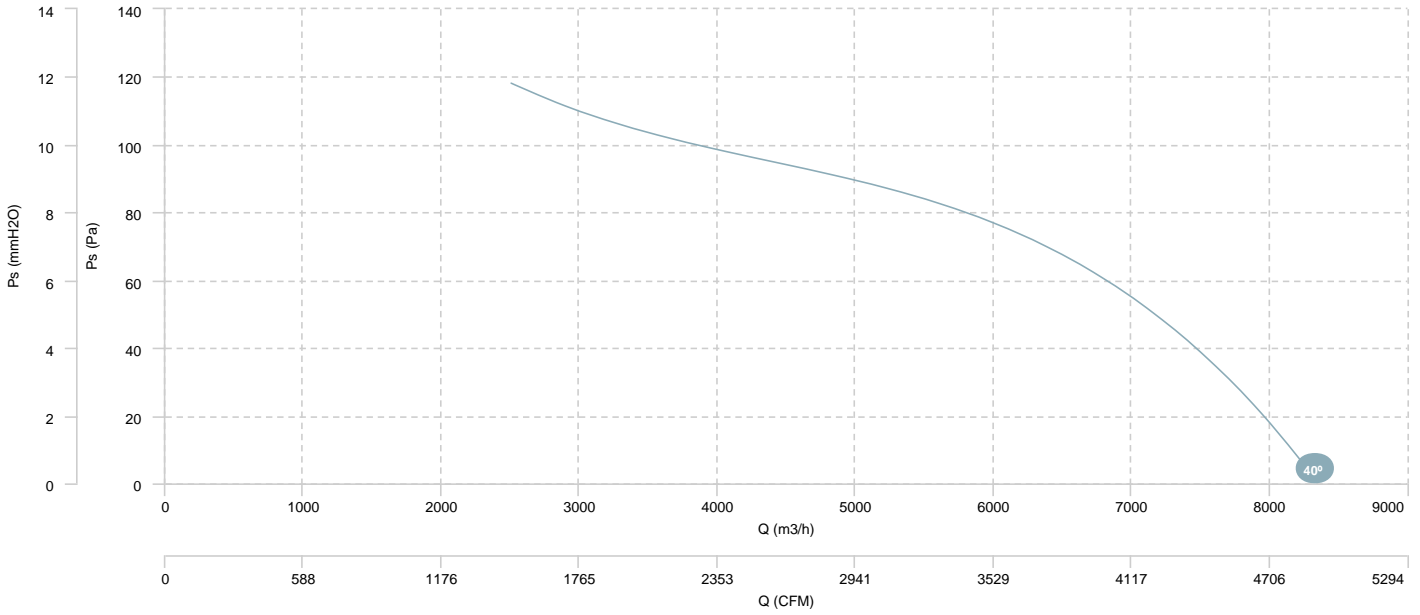

AIR FLOW - ABSORBED POWER

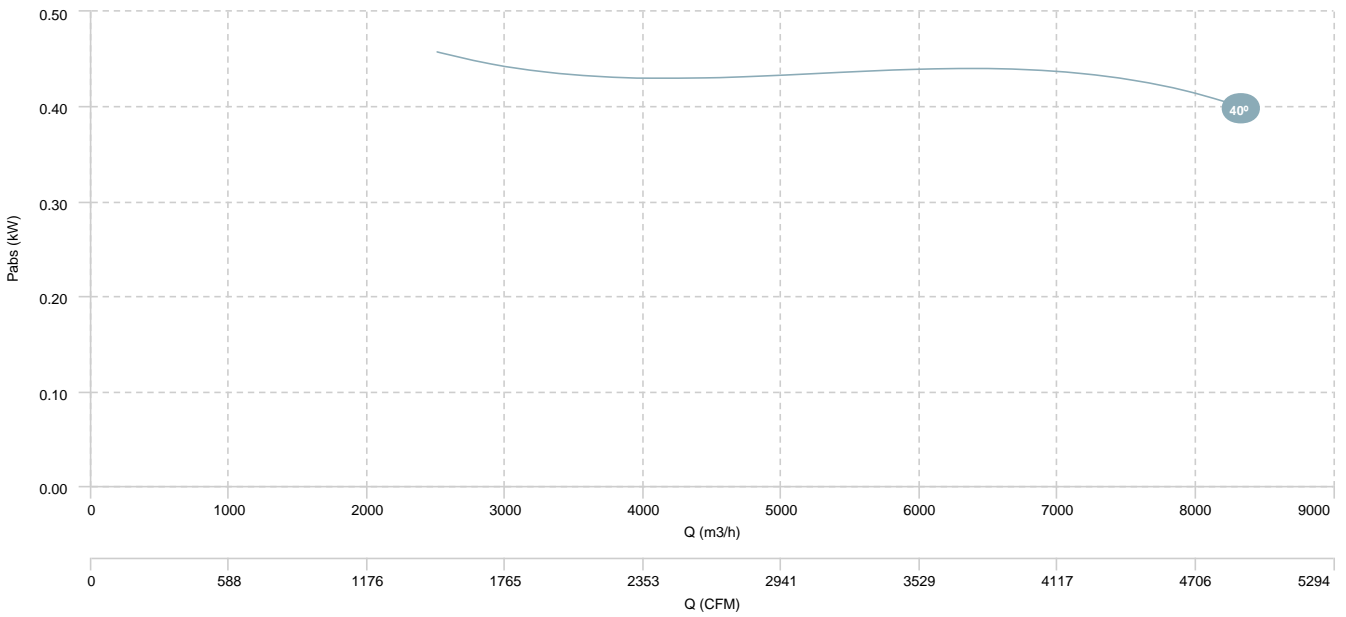

HBFX 56 T4/T8 0,8/0,2kW (A5:6)

HBFX 56 T4/T8 1,2/0,3kW (A5:6)

HBFX 56 T4/T8 1,6/0,4kW (A5:6)

AIR FLOW - PRESSURE (4 poles)

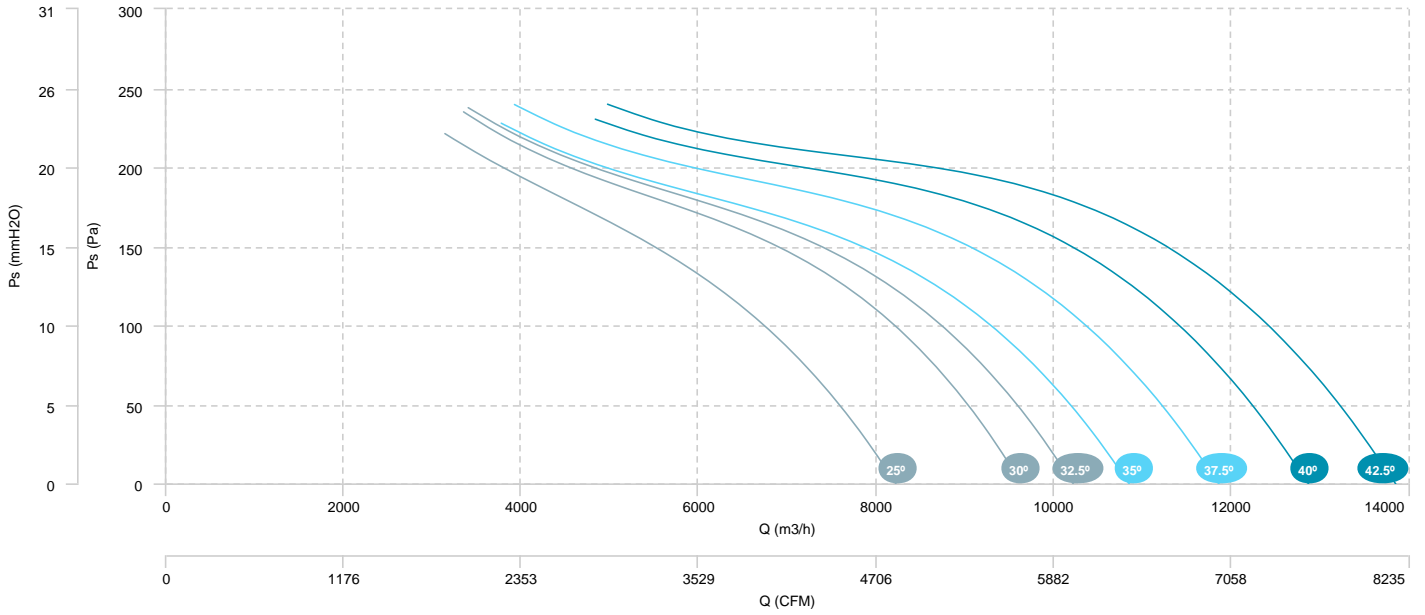

AIR FLOW - ABSORBED POWER (4 poles)

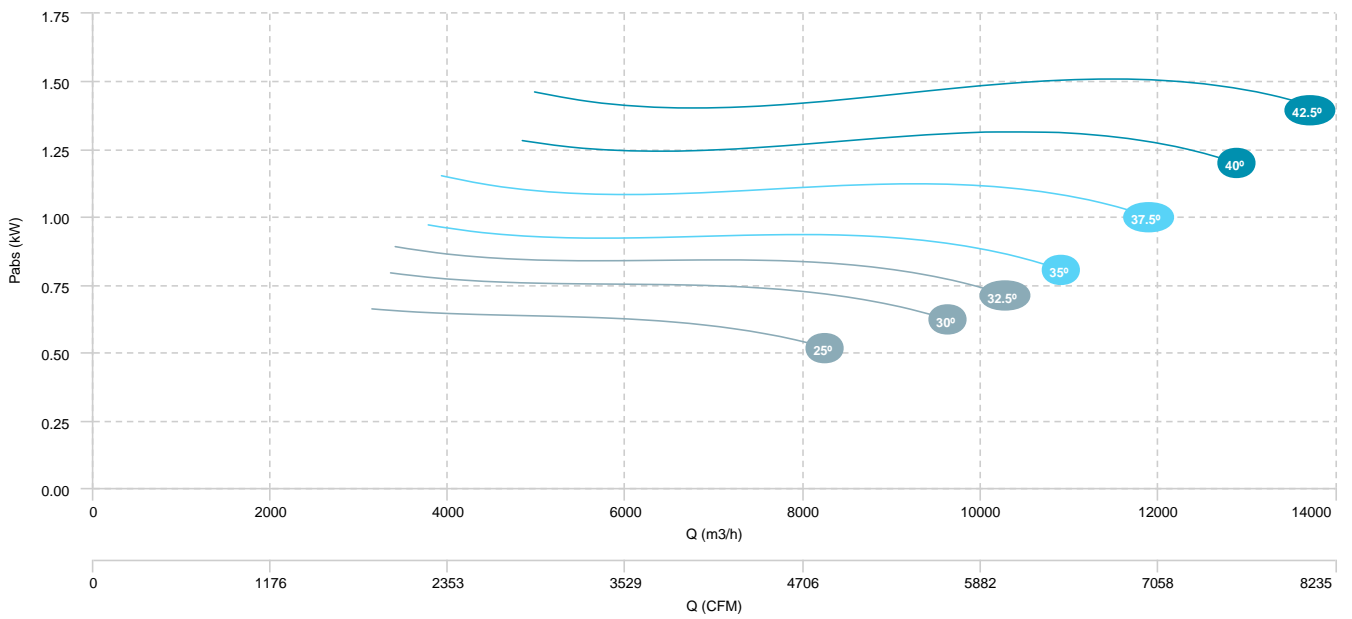

HBFX 56 T4/T8 0,8/0,2kW (A5:6)

HBFX 56 T4/T8 1,2/0,3kW (A5:6)

HBFX 56 T4/T8 1,6/0,4kW (A5:6)

AIR FLOW - PRESSURE (8 poles)

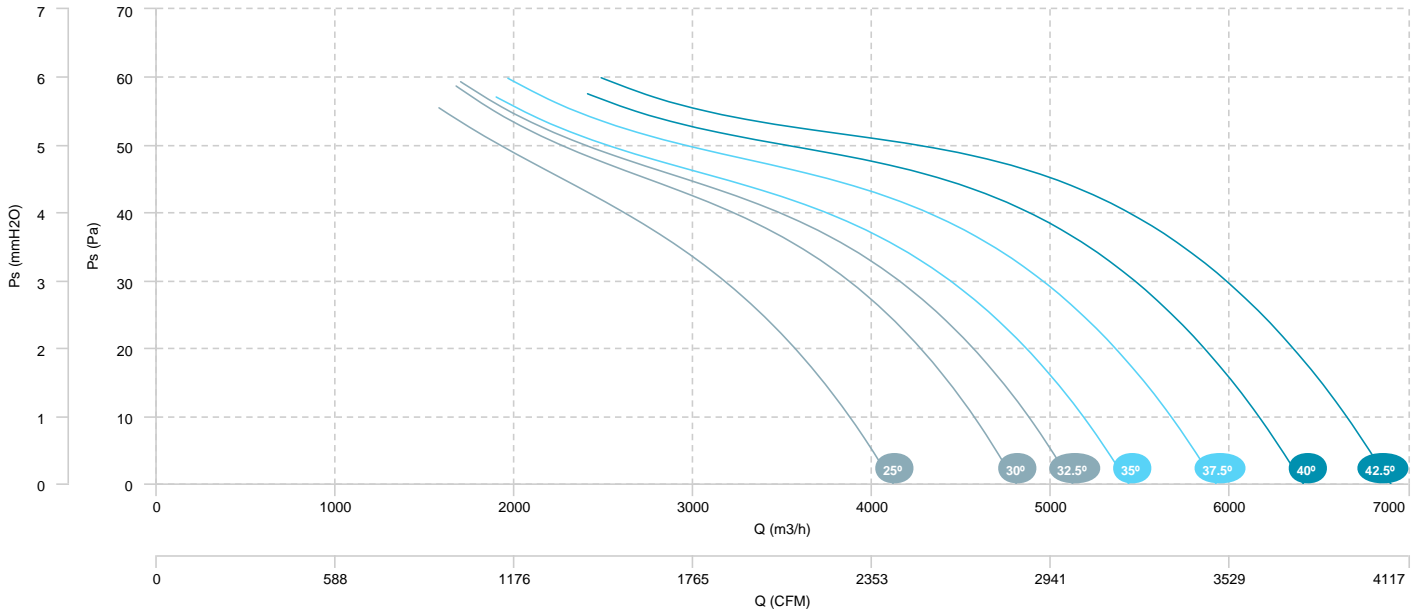

HBFX 63 T4 0,75kW (A5:6)	HBFX 63 T4 1,1kW (A5:6)	HBFX 63 T4 1,5kW (A5:6)
HBFX 63 T4 2,2kW (A5:6)		

AIR FLOW - PRESSURE

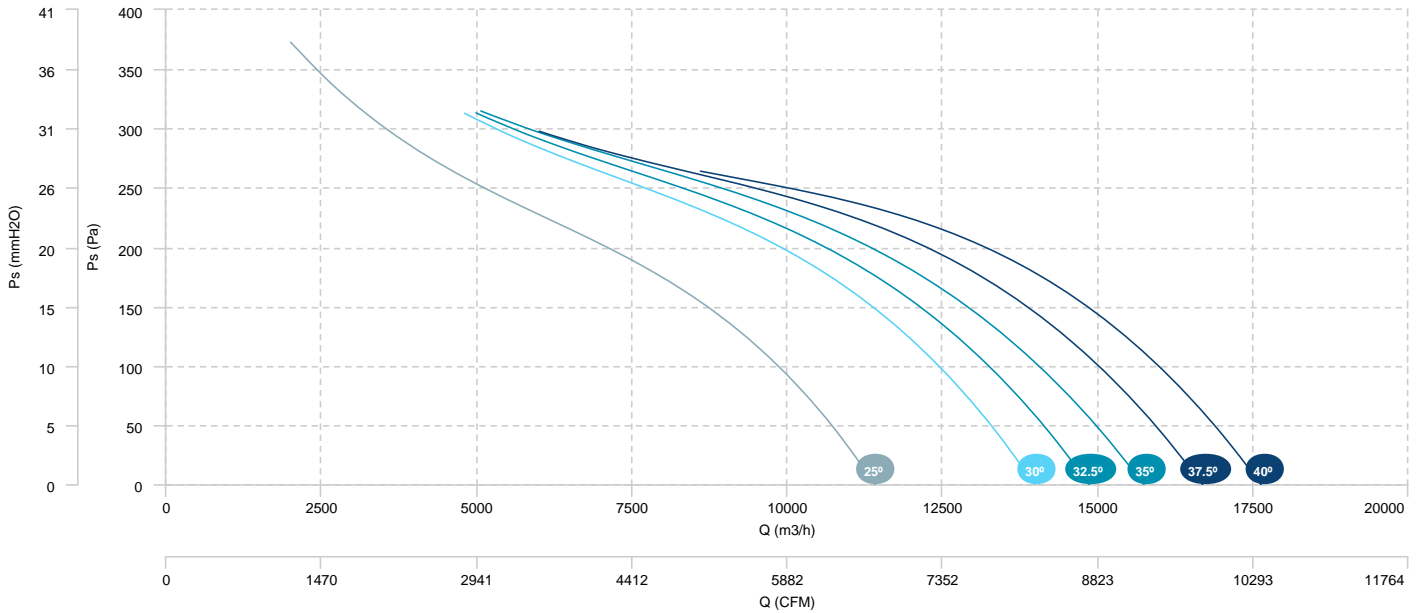

AIR FLOW - ABSORBED POWER

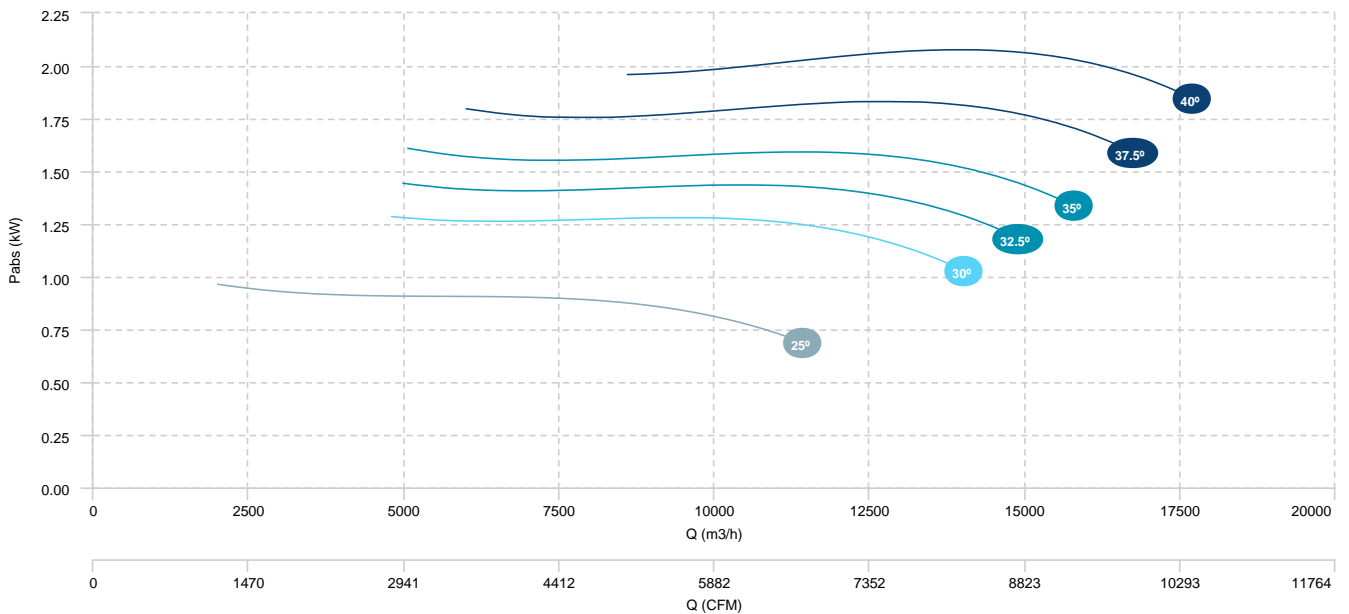



HBFX 63 T6 0,75kW (A5:6)

AIR FLOW - PRESSURE

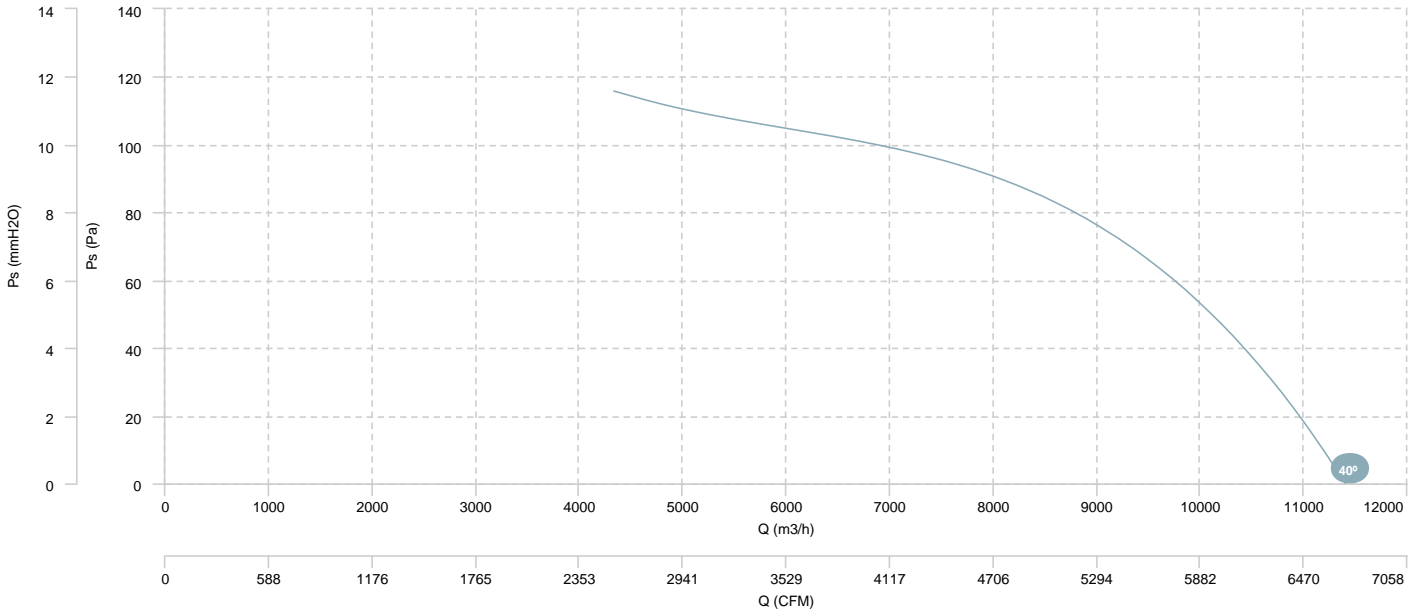

AIR FLOW - ABSORBED POWER

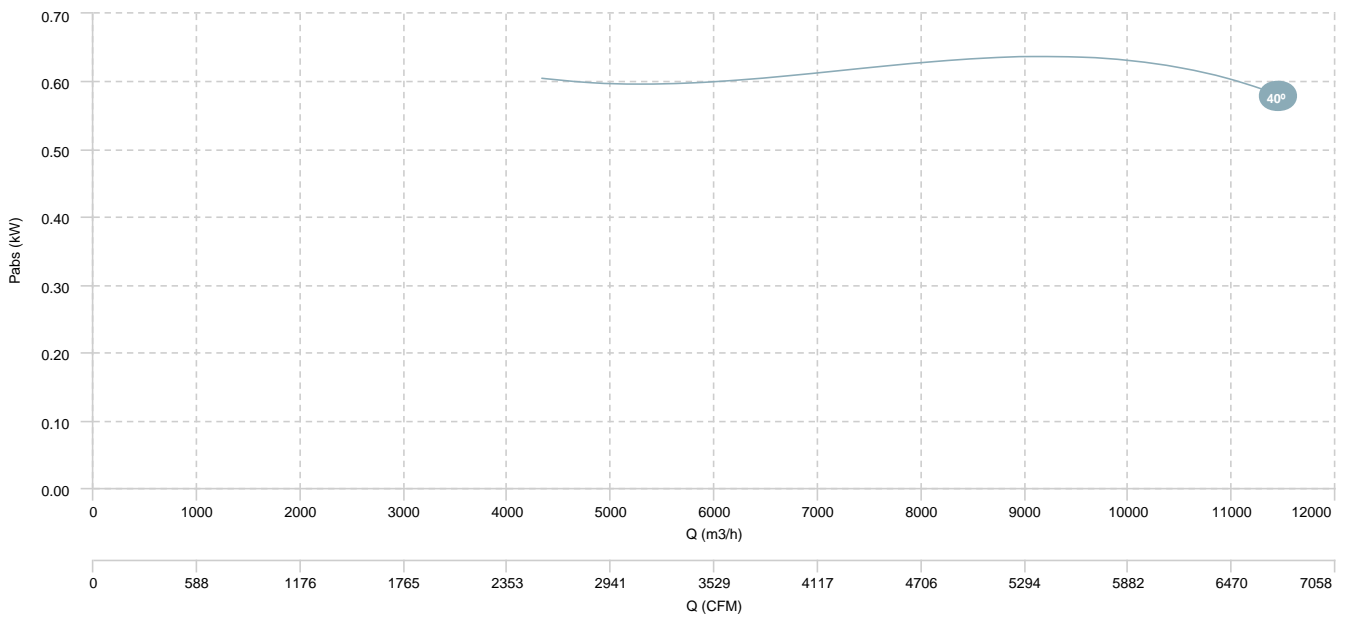

HBFX 63 T4/T8 0,8/0,2kW (A5:6)	HBFX 63 T4/T8 1,2/0,3kW (A5:6)	HBFX 63 T4/T8 1,6/0,4kW (A5:6)
HBFX 63 T4/T8 2,2/0,37kW (A5:6)		

**AIR FLOW - PRESSURE (4 poles)**

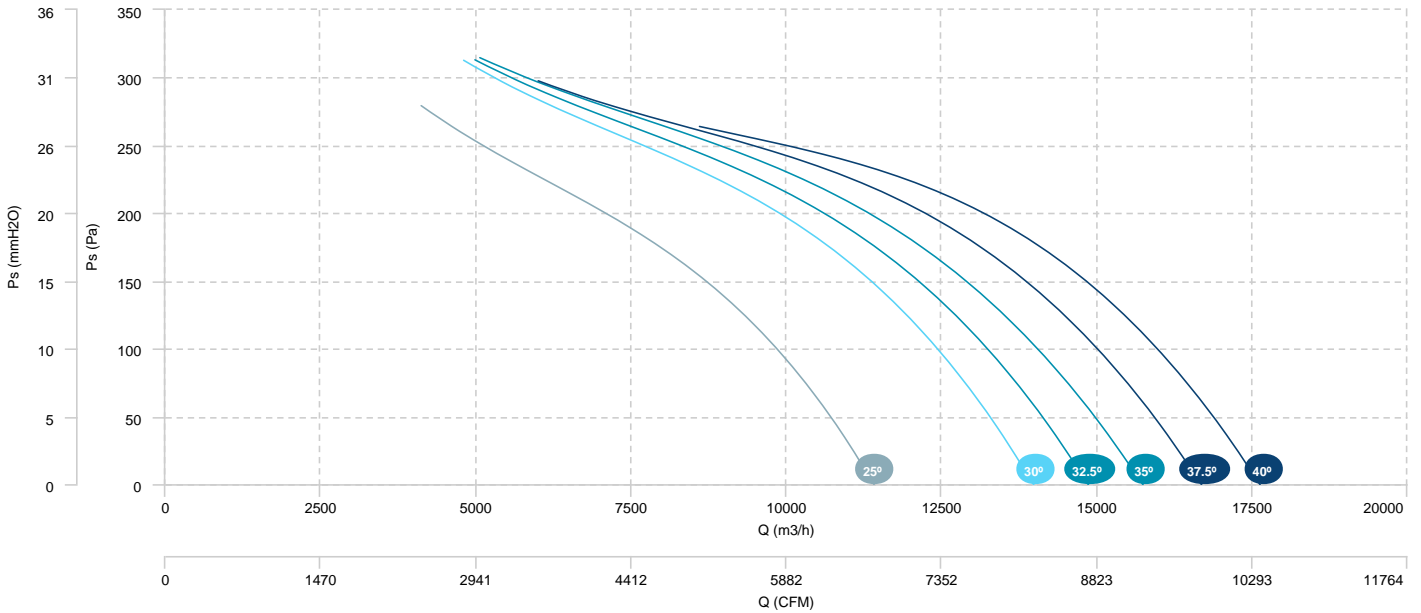

**AIR FLOW - ABSORBED POWER (4 poles)**

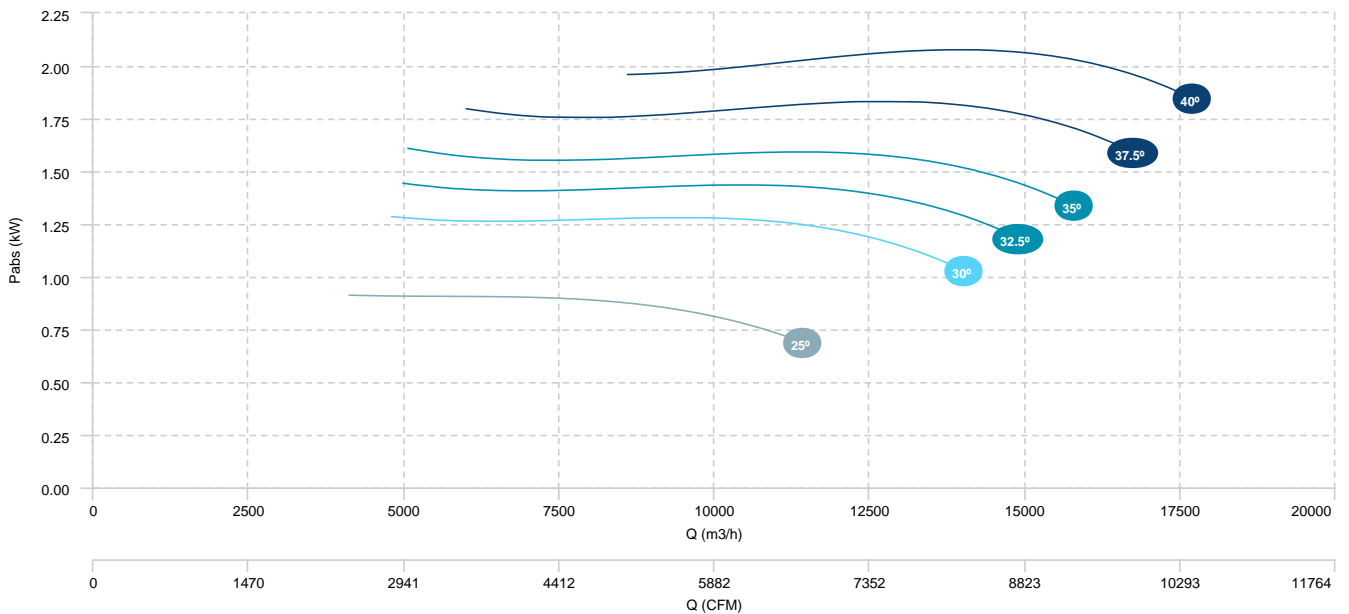

- HBFX 63 T4/T8 0,8/0,2kW (A5:6)
  - HBFX 63 T4/T8 1,2/0,3kW (A5:6)
  - HBFX 63 T4/T8 1,6/0,4kW (A5:6)
- HBFX 63 T4/T8 2,2/0,37kW (A5:6)

**AIR FLOW - PRESSURE (8 poles)**

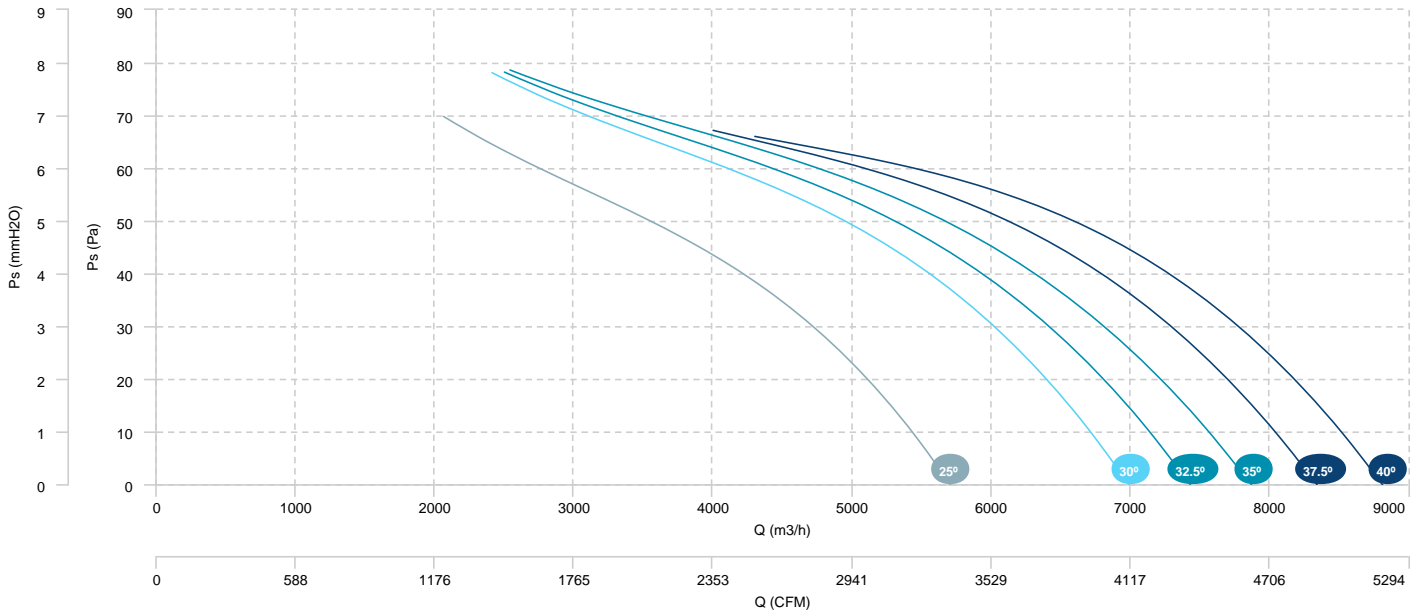

HBFX 71 T4 0,75kW (A5:6)	HBFX 71 T4 1,1kW (A5:6)	HBFX 71 T4 1,5kW (A5:6)
HBFX 71 T4 2,2kW (A5:6)	HBFX 71 T4 3kW (A5:6)	

AIR FLOW - PRESSURE

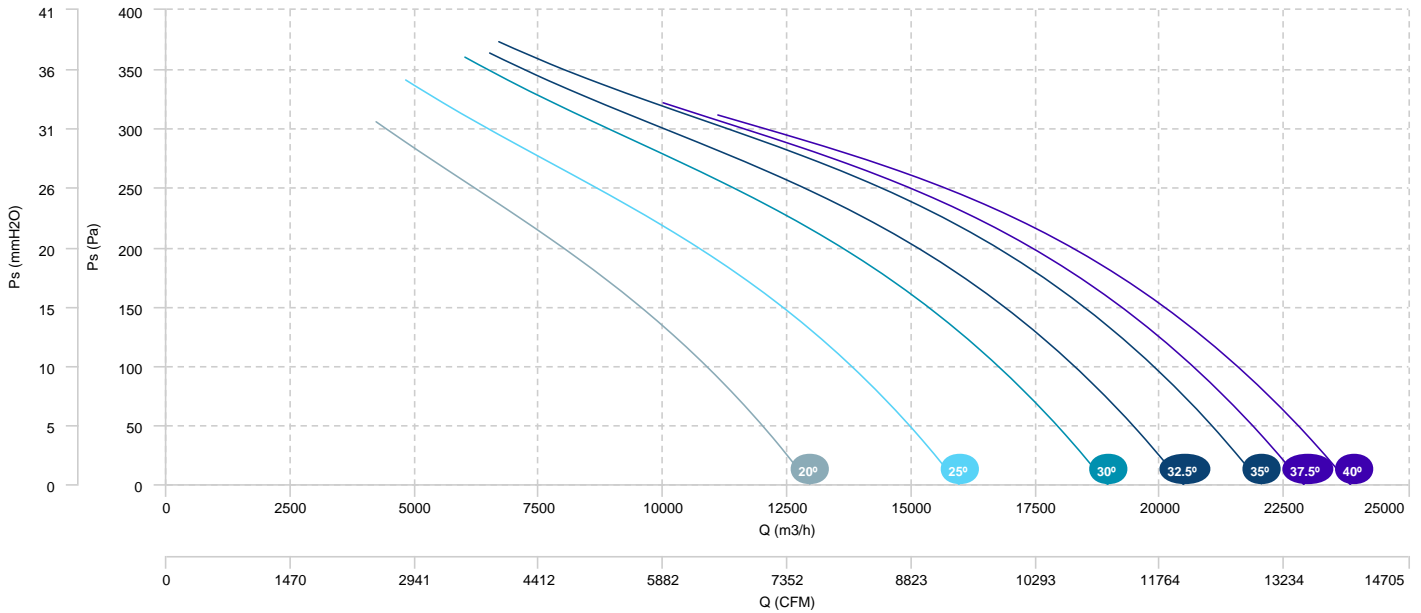

AIR FLOW - ABSORBED POWER

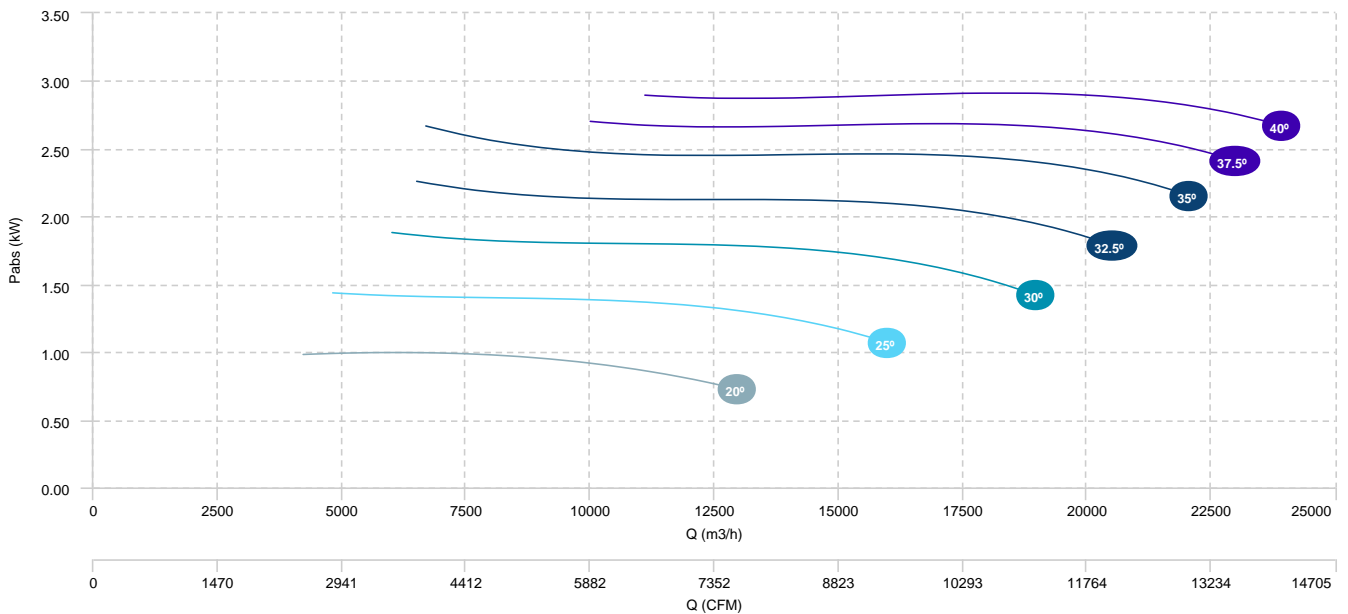

HBFX 71 T6 0,75kW (A5:6)

AIR FLOW - PRESSURE

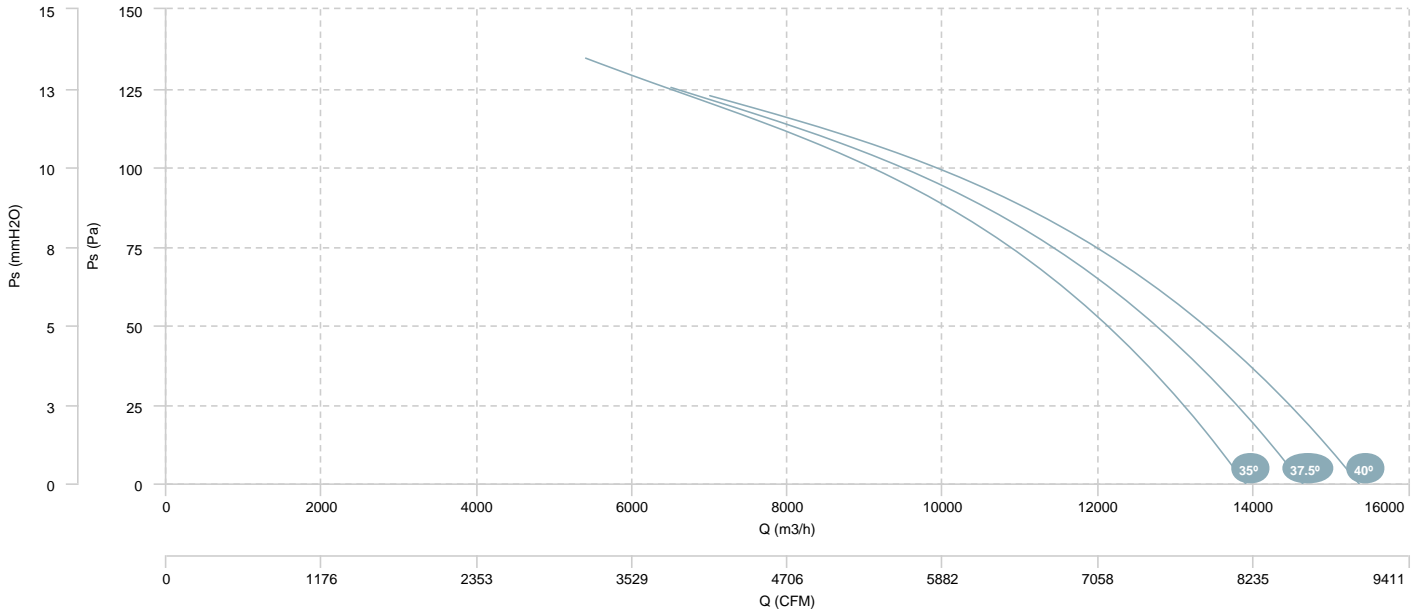

AIR FLOW - ABSORBED POWER

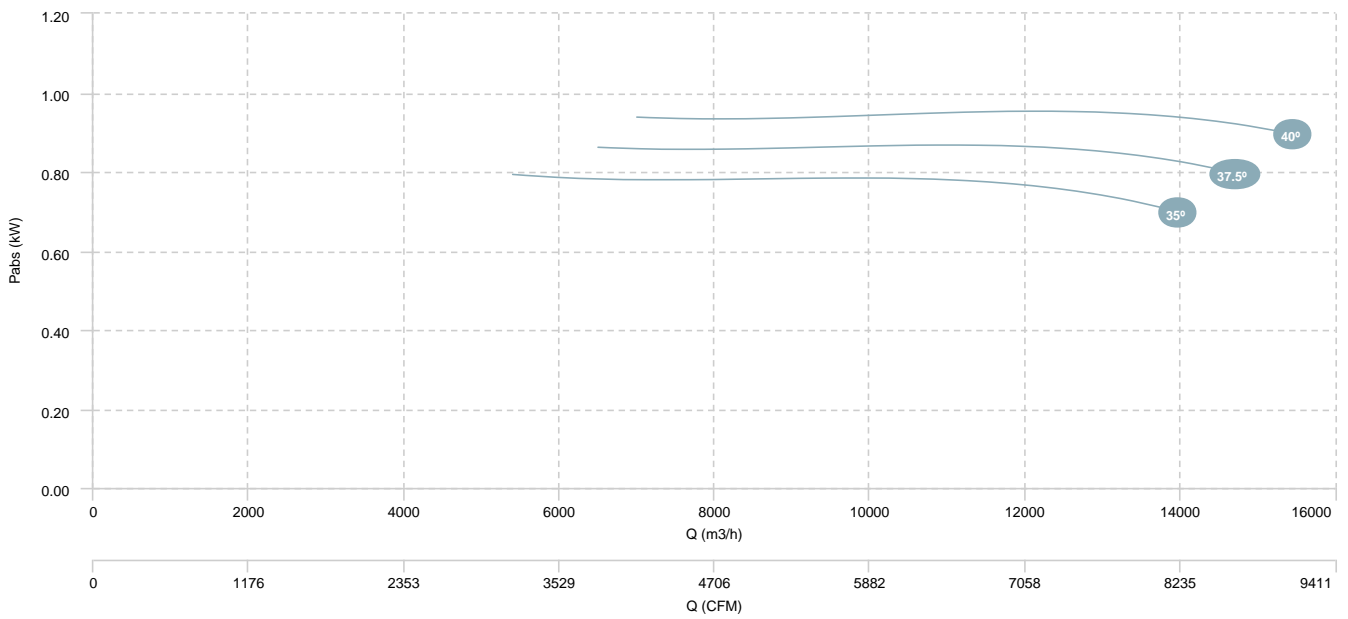

HBFX 71 T4/T8 0,8/0,2kW (A5:6)	HBFX 71 T4/T8 1,2/0,3kW (A5:6)	HBFX 71 T4/T8 1,6/0,4kW (A5:6)
HBFX 71 T4/T8 2,2/0,37kW (A5:6)	HBFX 71 T4/T8 3/0,55kW (A5:6)	

**AIR FLOW - PRESSURE (4 poles)**

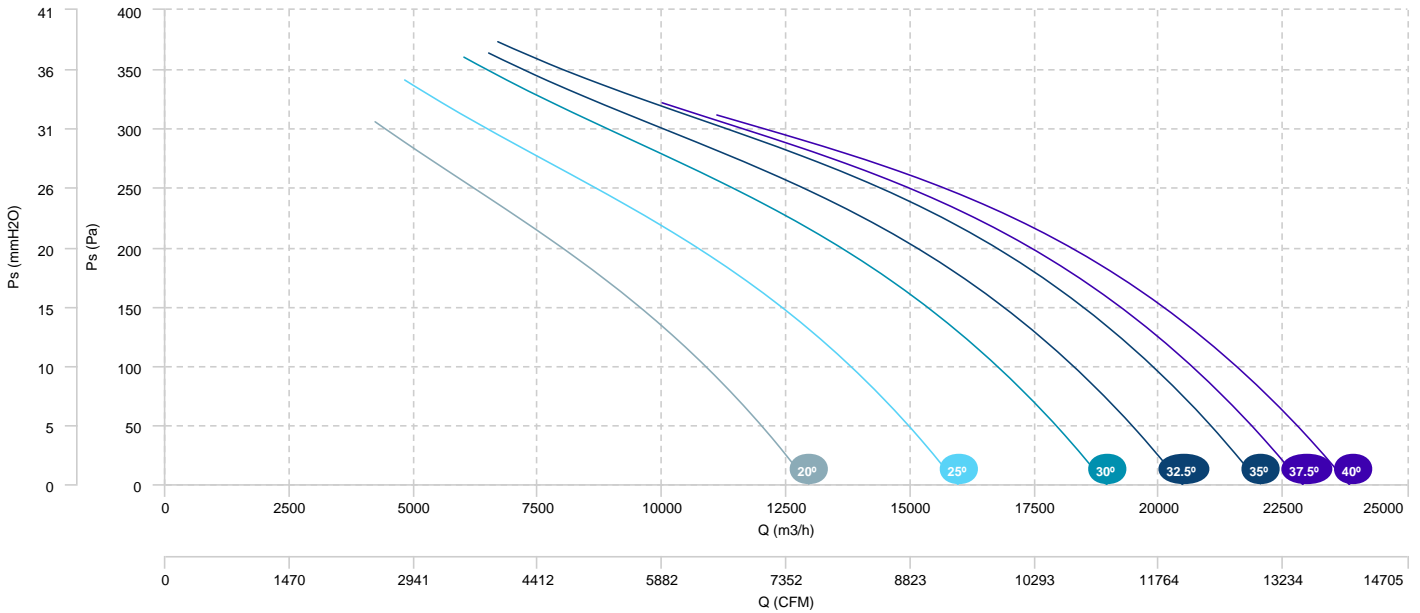

**AIR FLOW - ABSORBED POWER (4 poles)**

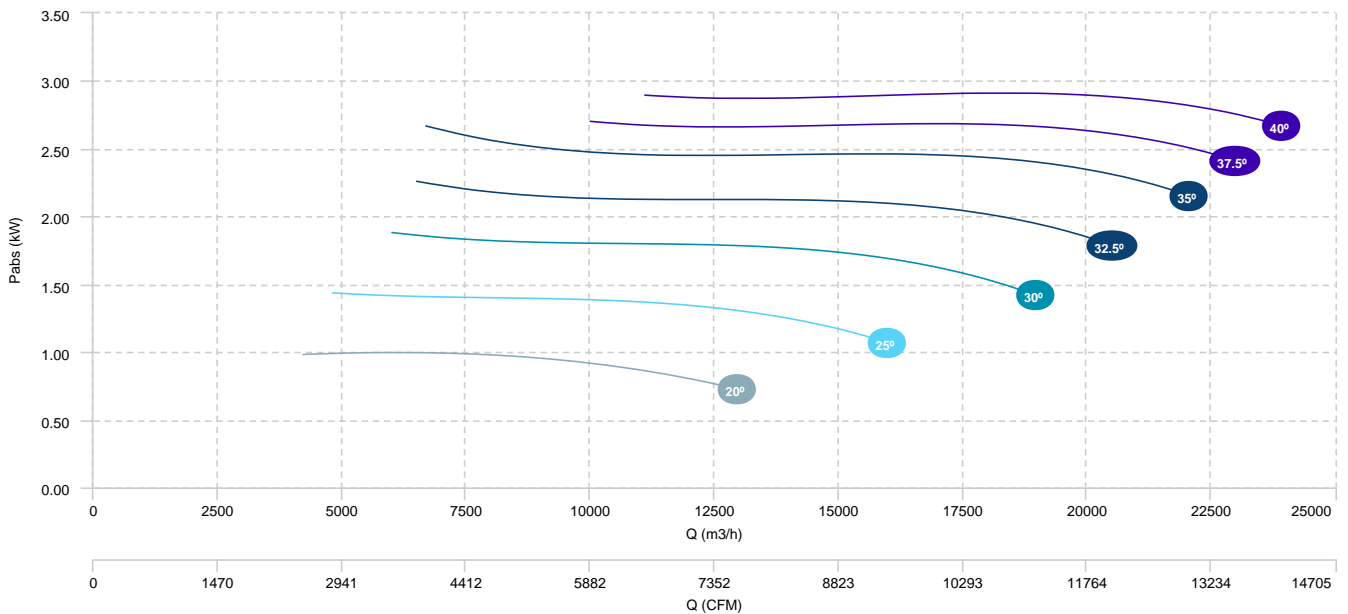

HBFX 71 T4/T8 0,8/0,2kW (A5:6)	HBFX 71 T4/T8 1,2/0,3kW (A5:6)	HBFX 71 T4/T8 1,6/0,4kW (A5:6)
HBFX 71 T4/T8 2,2/0,37kW (A5:6)	HBFX 71 T4/T8 3/0,55kW (A5:6)	

AIR FLOW - PRESSURE (8 poles)

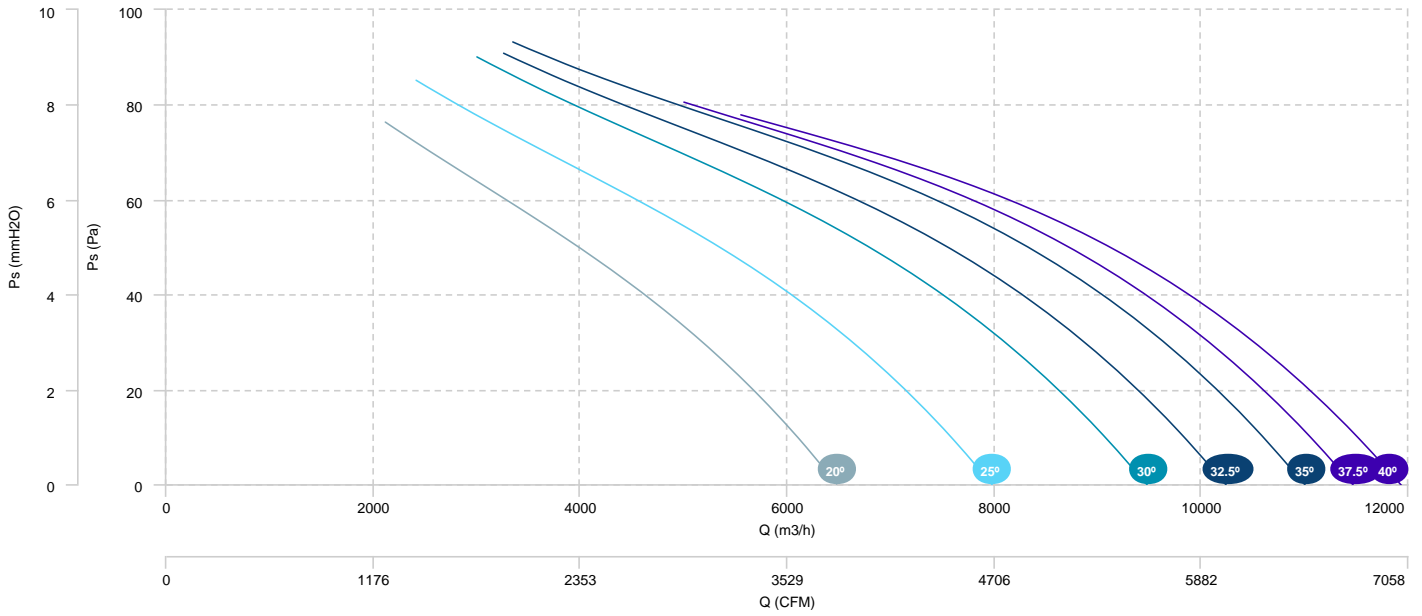

HBFX 80 T4 3kW (A5:6)

HBFX 80 T4 4kW (A5:6)

AIR FLOW - PRESSURE

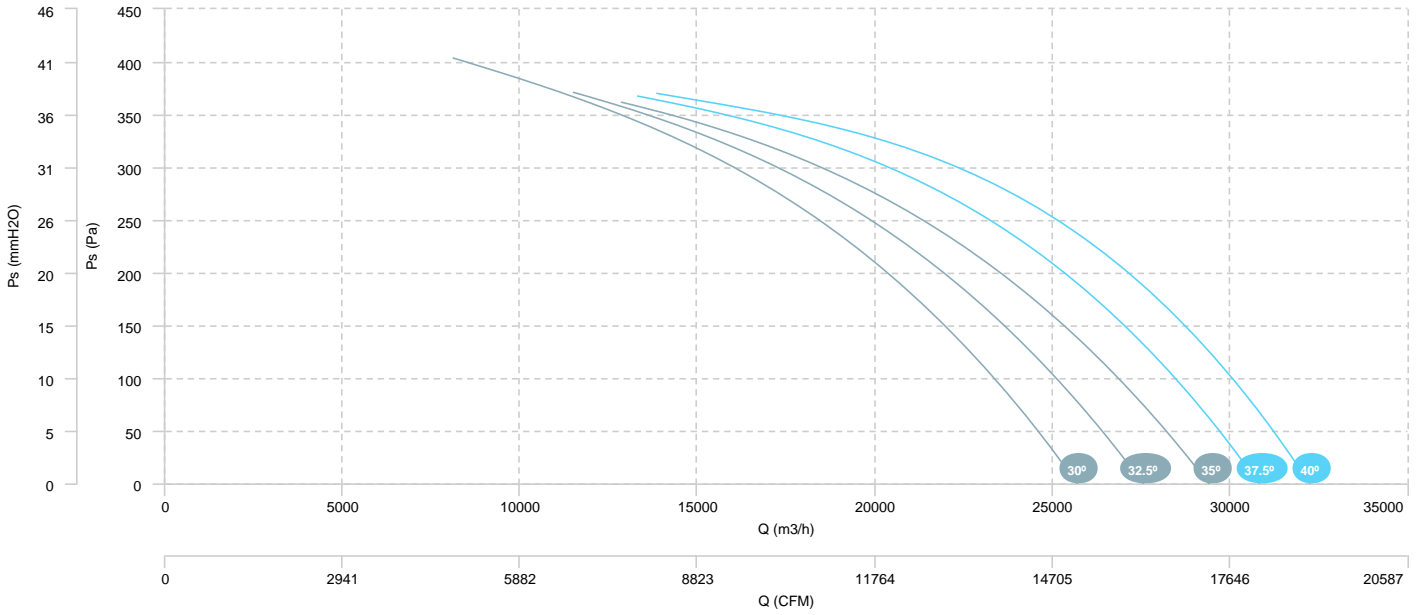

AIR FLOW - ABSORBED POWER

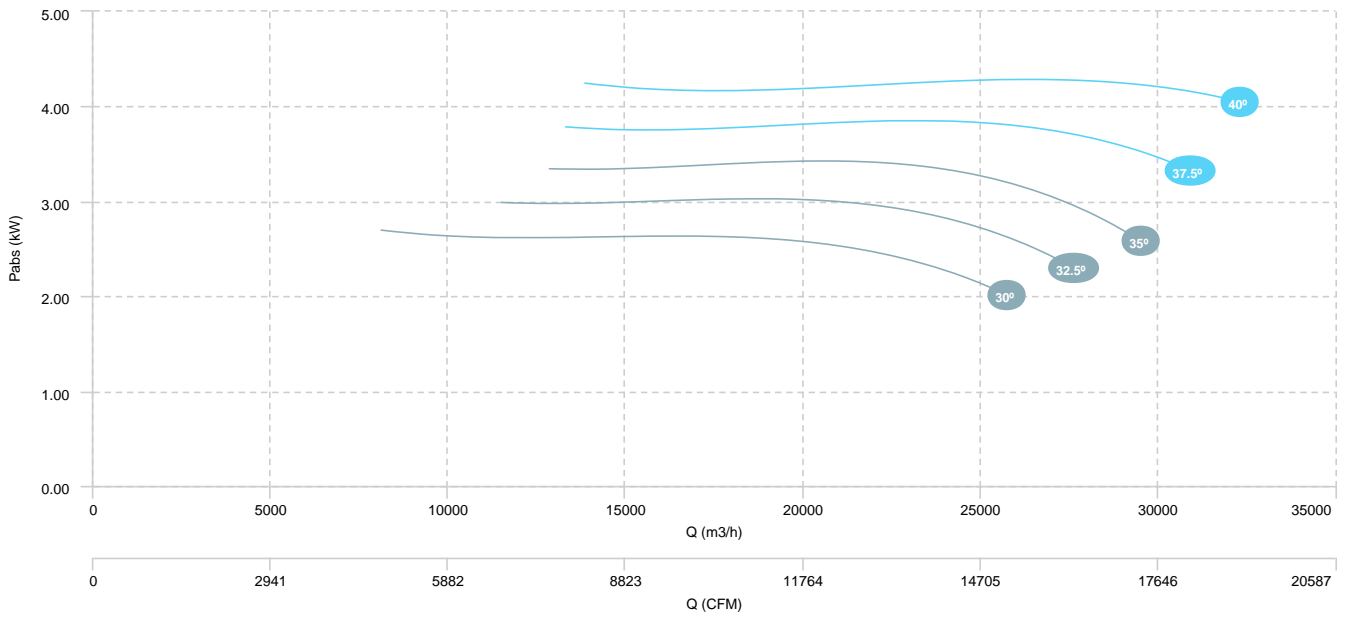



HBFX 80 T6 0,75kW (A5:6)	HBFX 80 T6 1,1kW (A5:6)	HBFX 80 T6 1,5kW (A5:6)
HBFX 80 T6 2,2kW (A5:6)		

AIR FLOW - PRESSURE

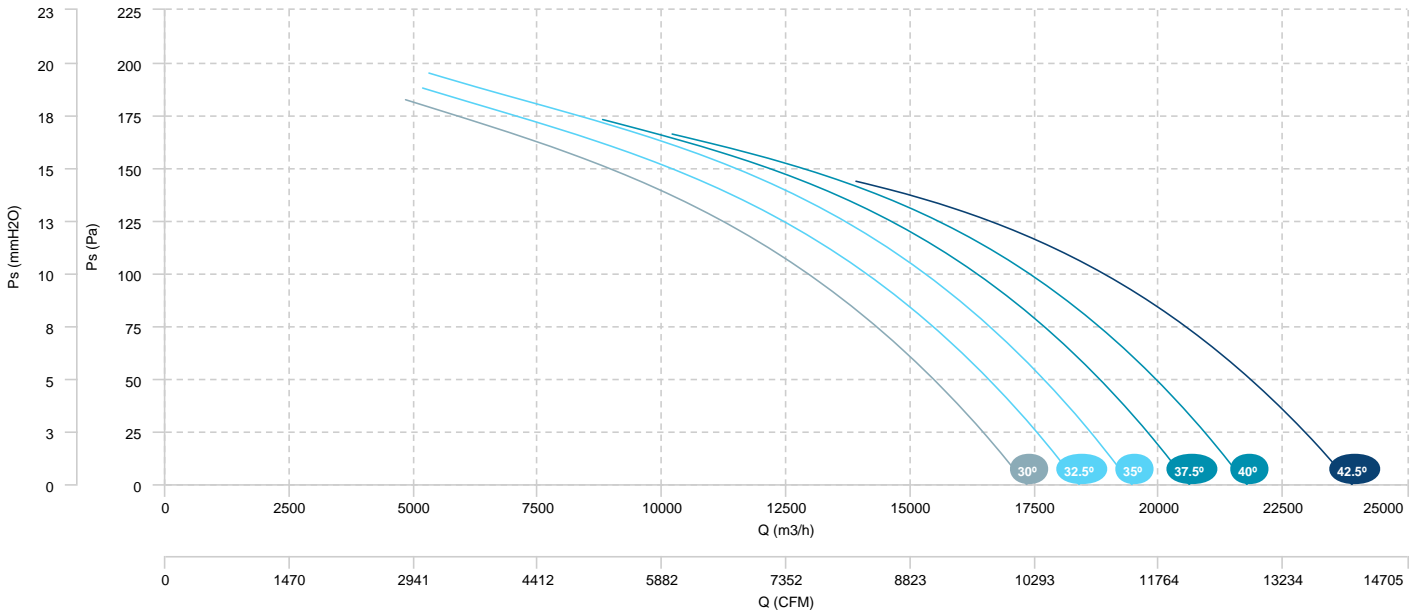

AIR FLOW - ABSORBED POWER

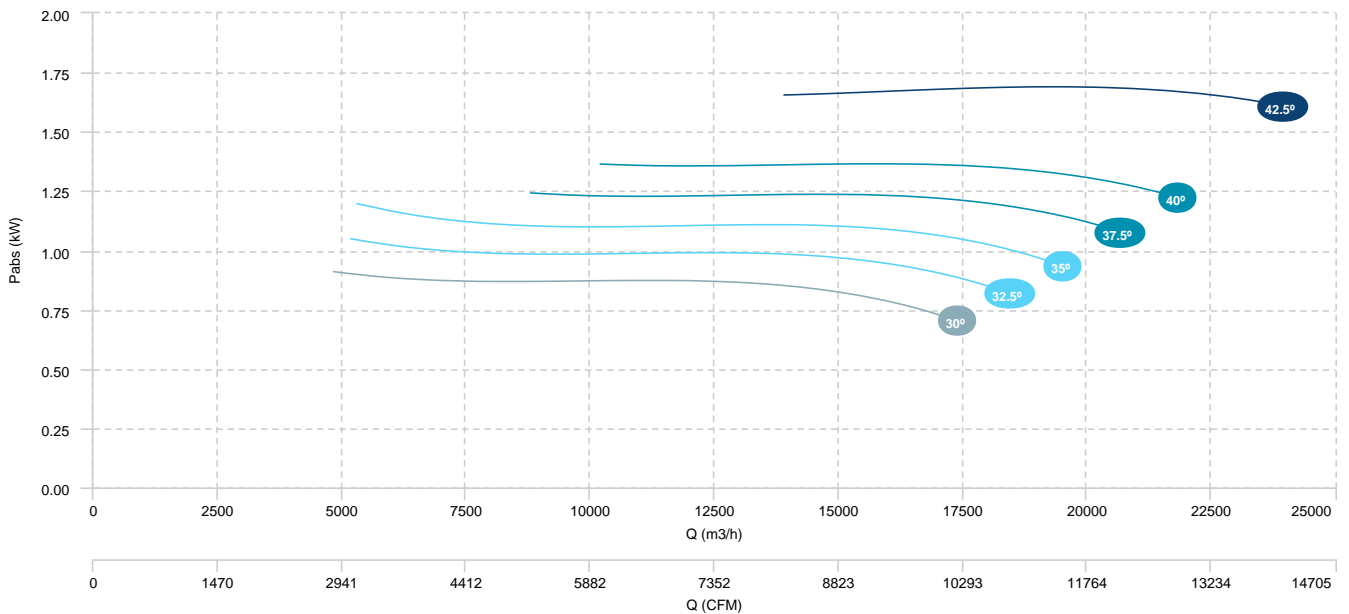

HBFX 80 T4/T8 3/0,55kW (A5:6)

HBFX 80 T4/T8 4/0,75kW (A5:6)

AIR FLOW - PRESSURE (4 poles)

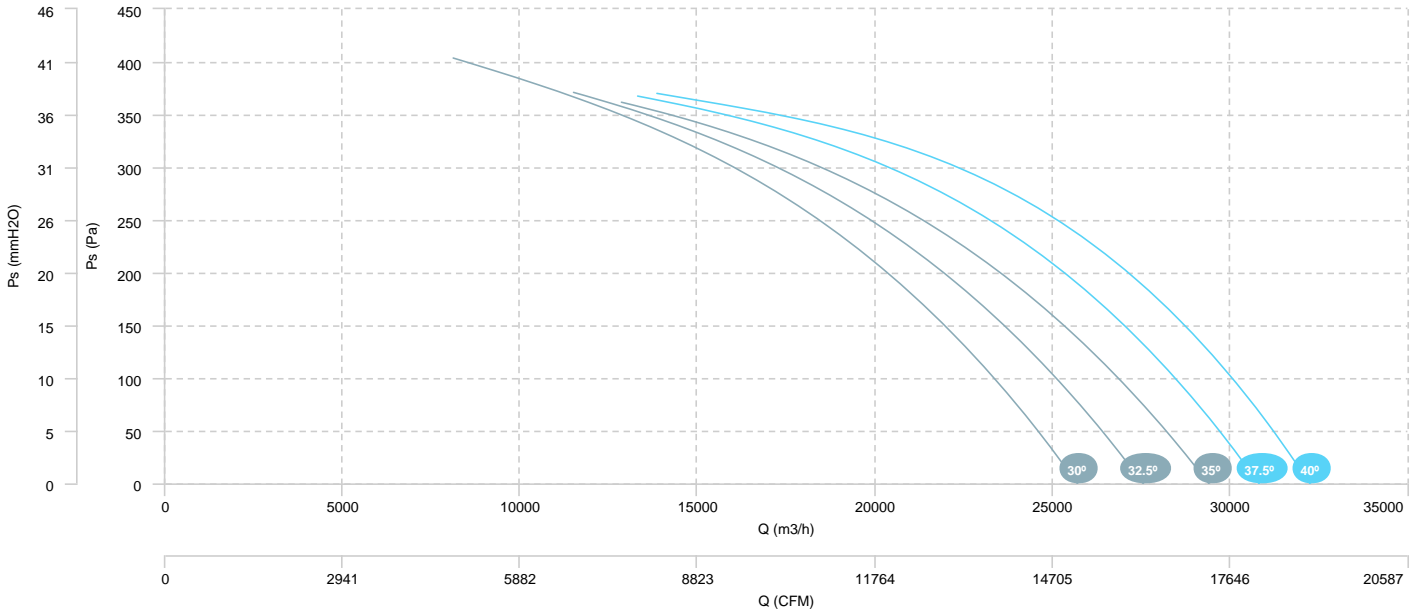

AIR FLOW - ABSORBED POWER (4 poles)

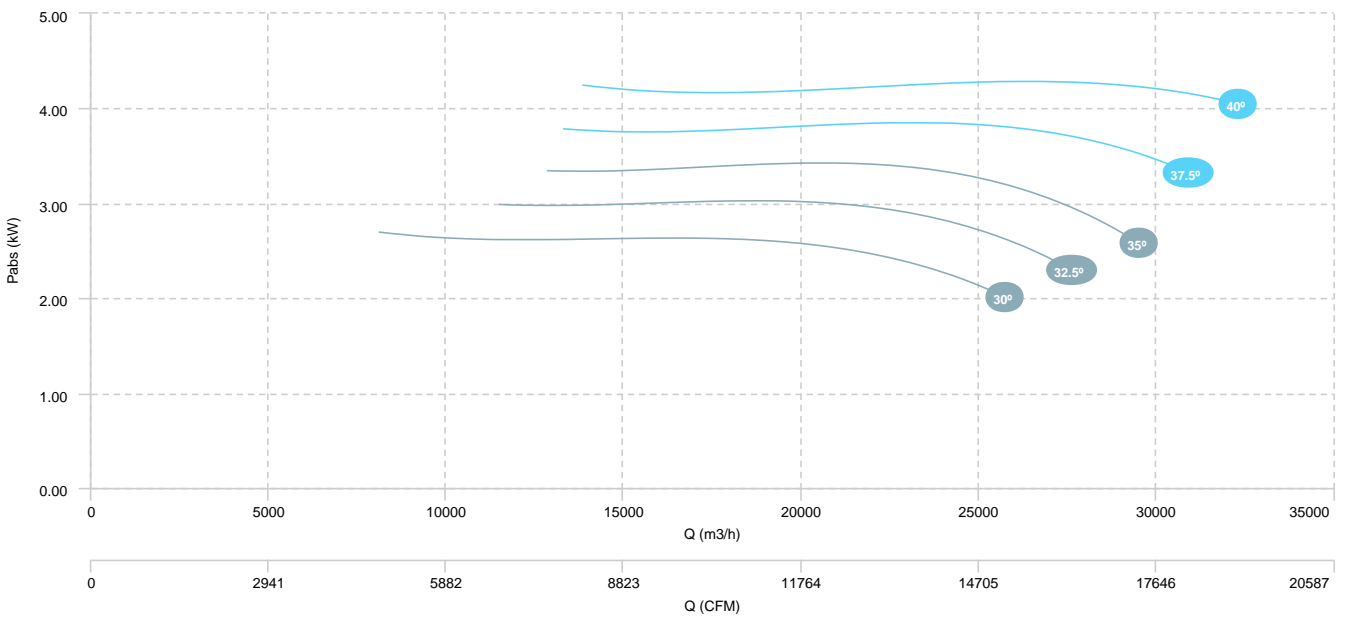

HBFX 80 T4/T8 3/0,55kW (A5:6)

HBFX 80 T4/T8 4/0,75kW (A5:6)

AIR FLOW - PRESSURE (8 poles)

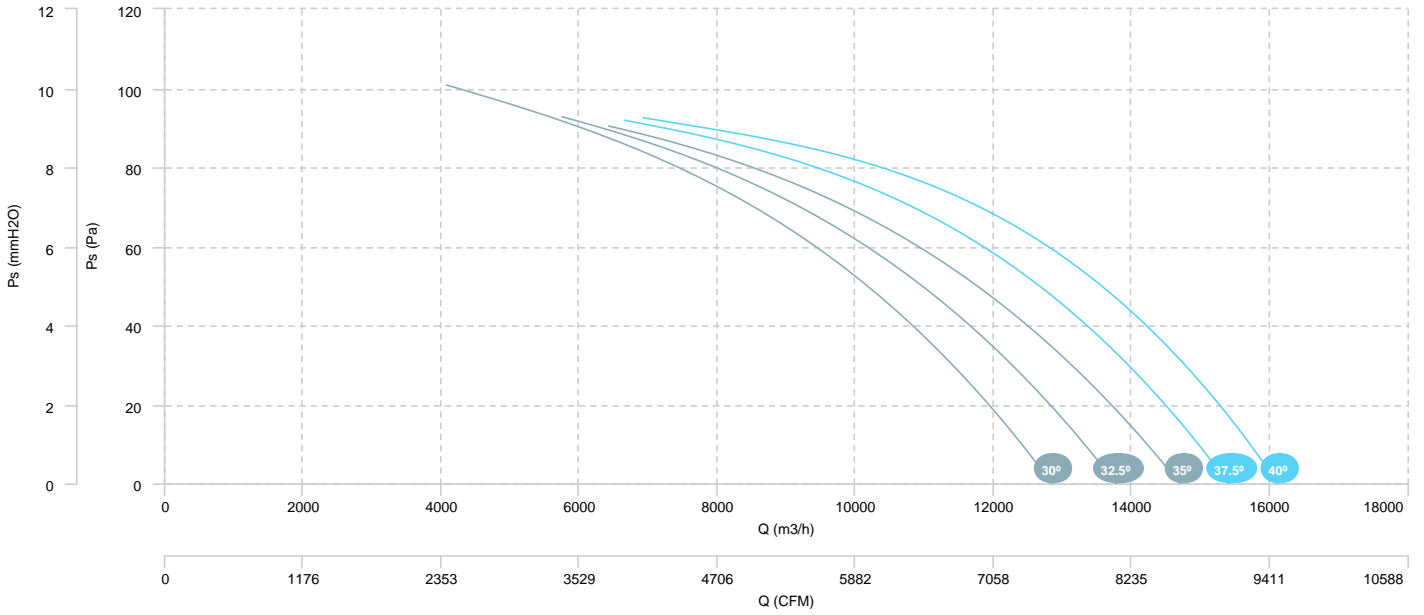

HBFX 90 T4 3kW (A3:4)	HBFX 90 T4 4kW (A3:4)	HBFX 90 T4 5,5kW (A3:4)
HBFX 90 T4 7,5kW (A3:4)	HBFX 90 T4 11kW (A3:4)	

**AIR FLOW - PRESSURE**

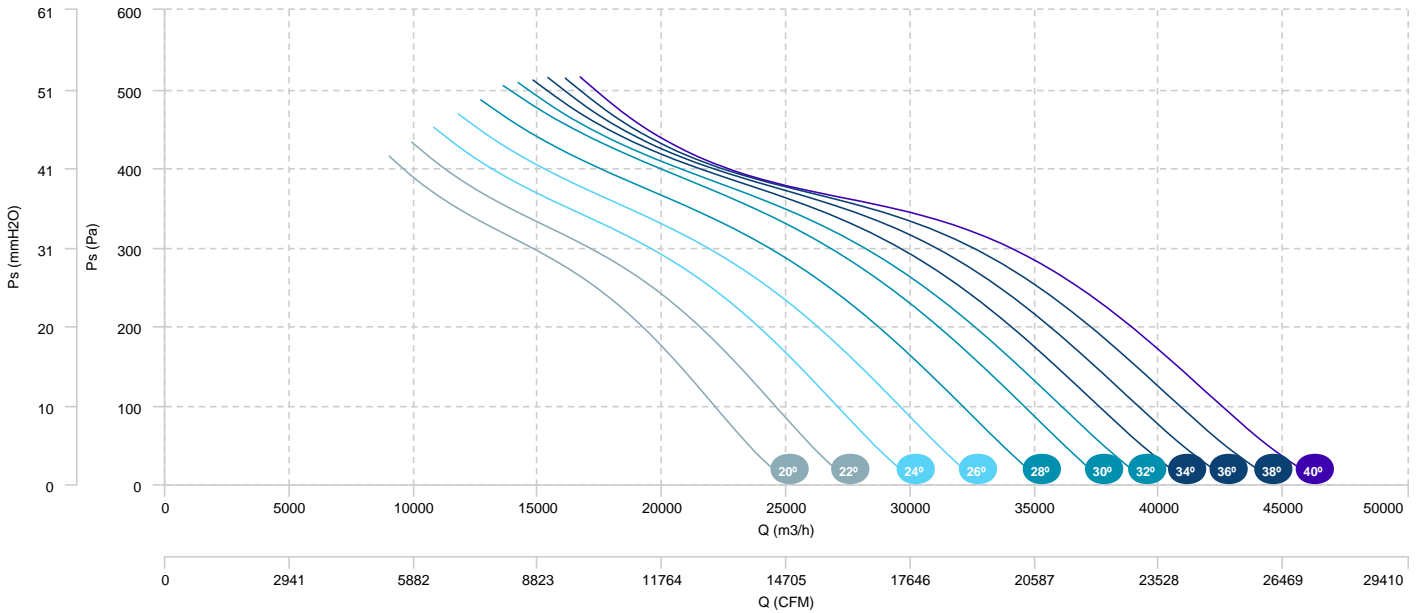

**AIR FLOW - ABSORBED POWER**

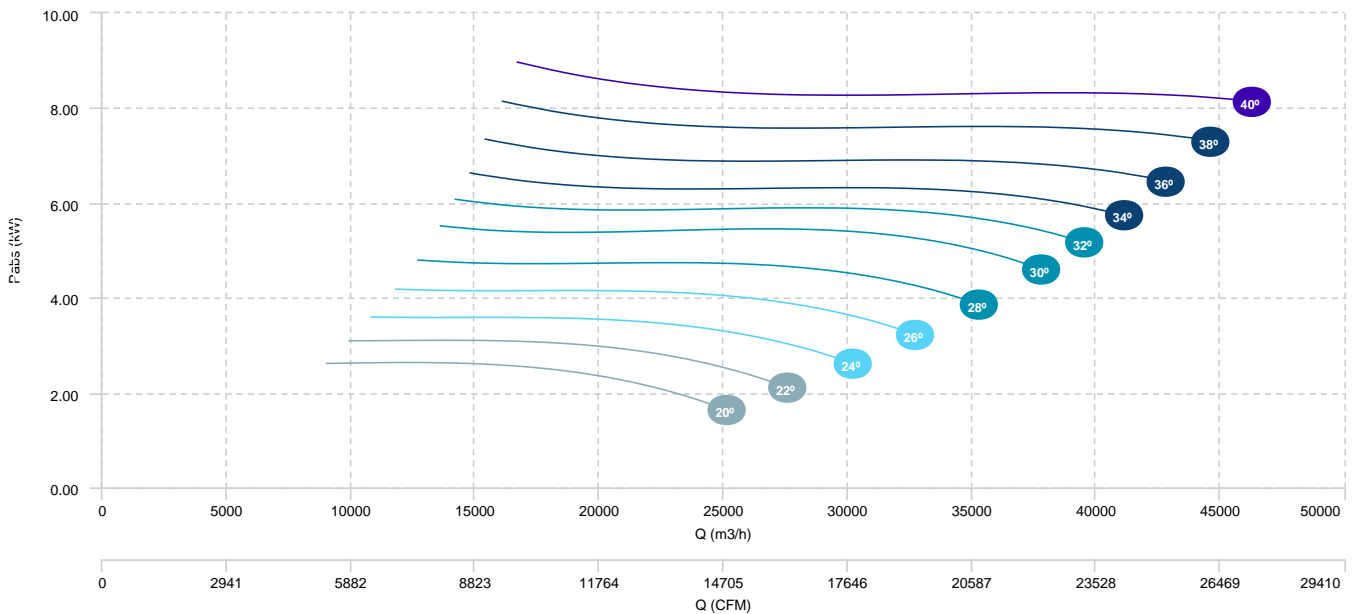

HBFX 90 T4 5,5kW (A3:8)	HBFX 90 T4 7,5kW (A3:8)	HBFX 90 T4 11kW (A3:8)
HBFX 90 T4 15kW (A3:8)		

AIR FLOW - PRESSURE

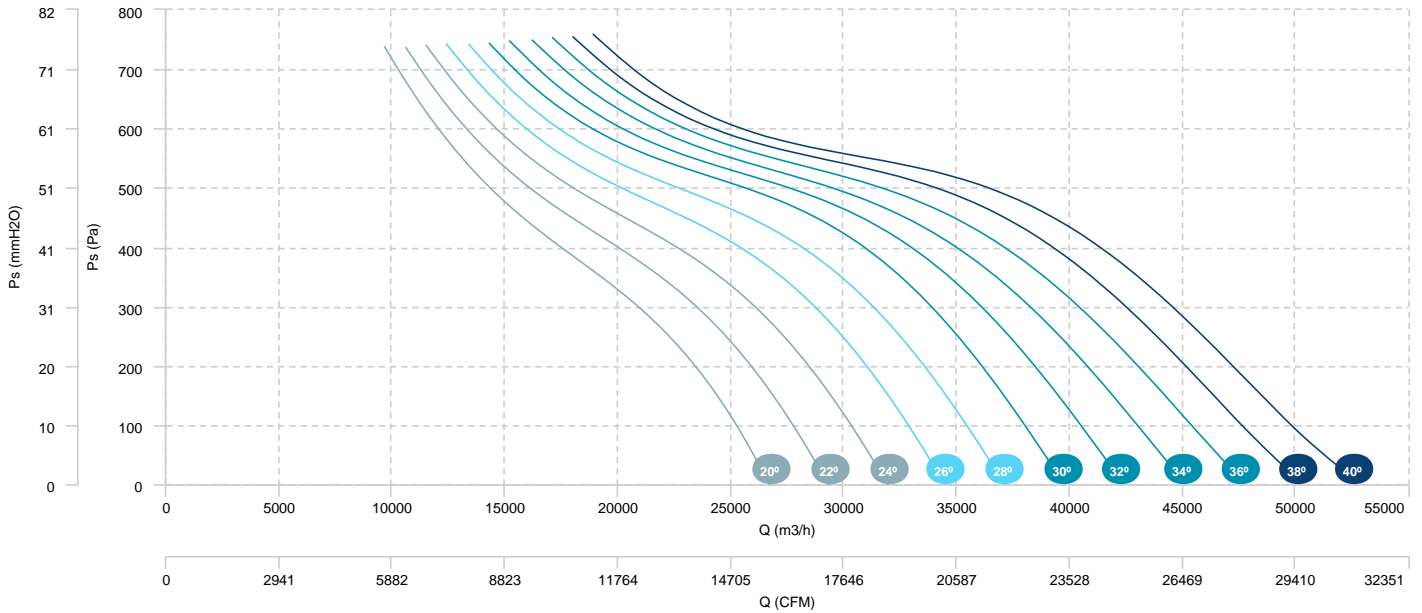

AIR FLOW - ABSORBED POWER

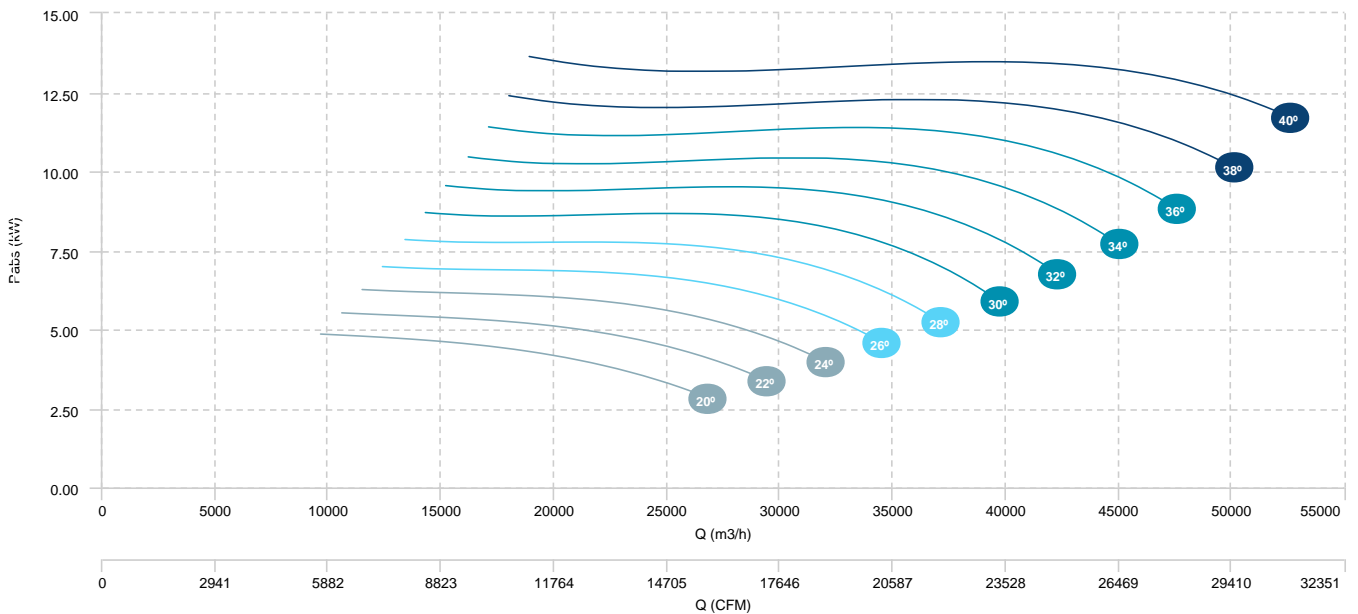

HBFX 90 T6 1,5kW (A3:8)	HBFX 90 T6 2,2kW (A3:8)	HBFX 90 T6 3kW (A3:8)
HBFX 90 T6 4kW (A3:8)		

AIR FLOW - PRESSURE

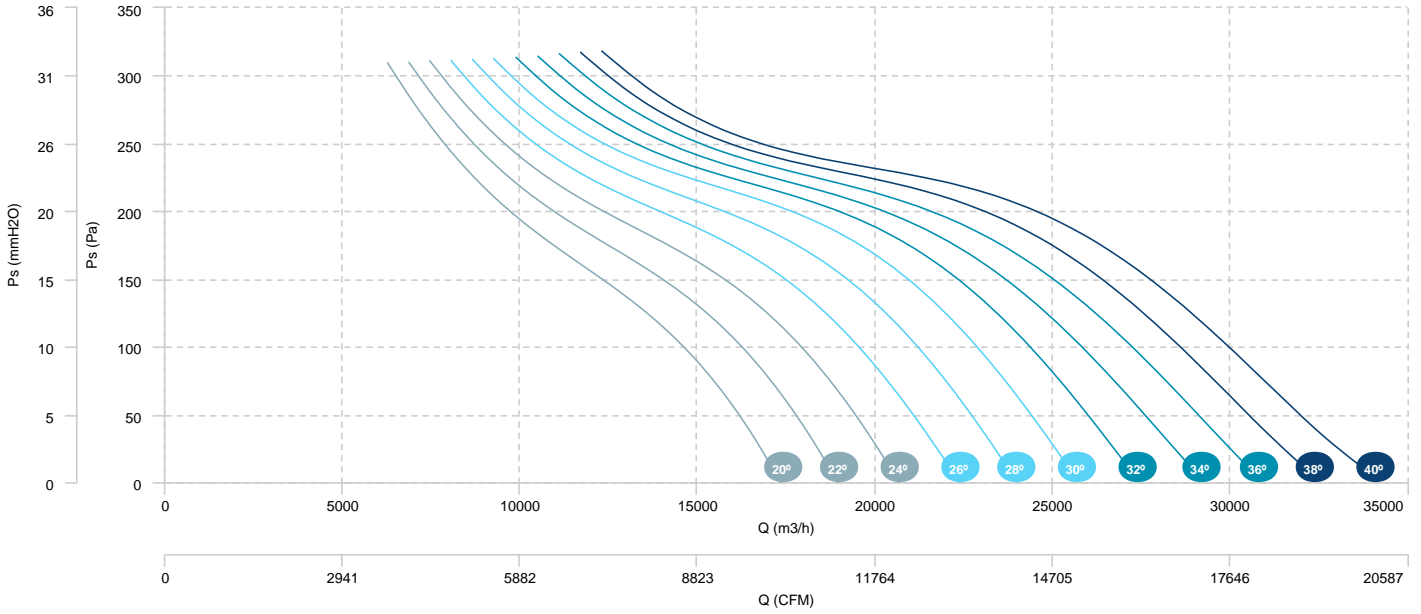

AIR FLOW - ABSORBED POWER

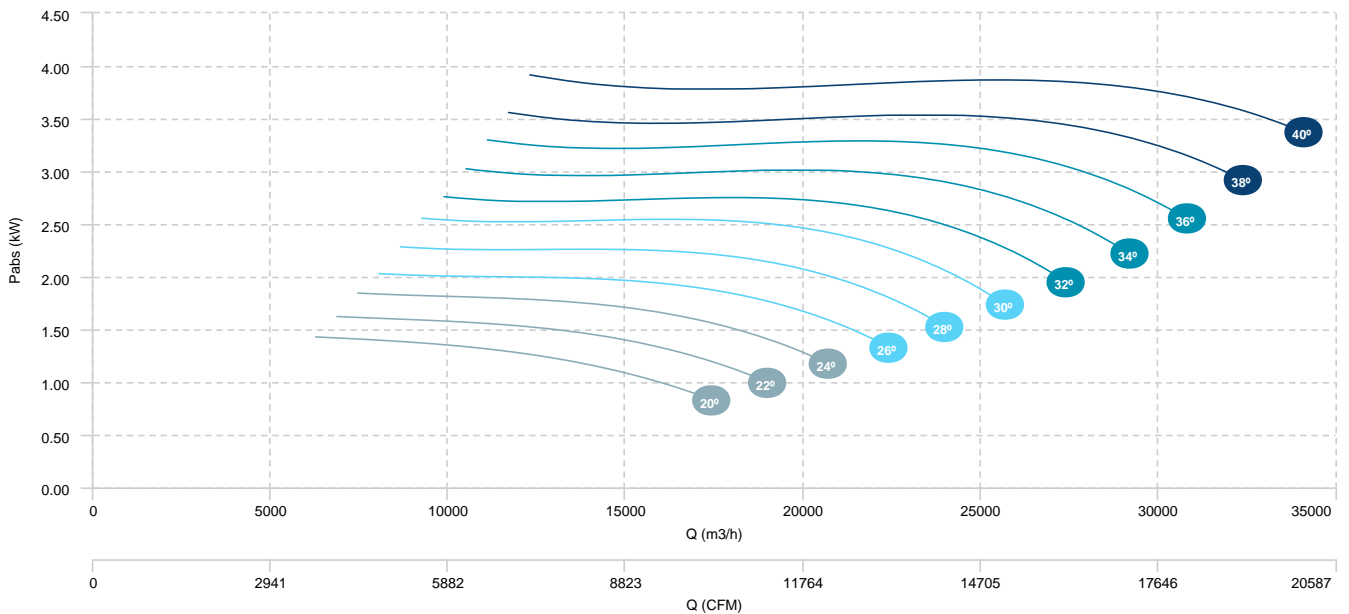

HBFX 90 T6 1,5kW (A3:4)

HBFX 90 T6 2,2kW (A3:4)

AIR FLOW - PRESSURE

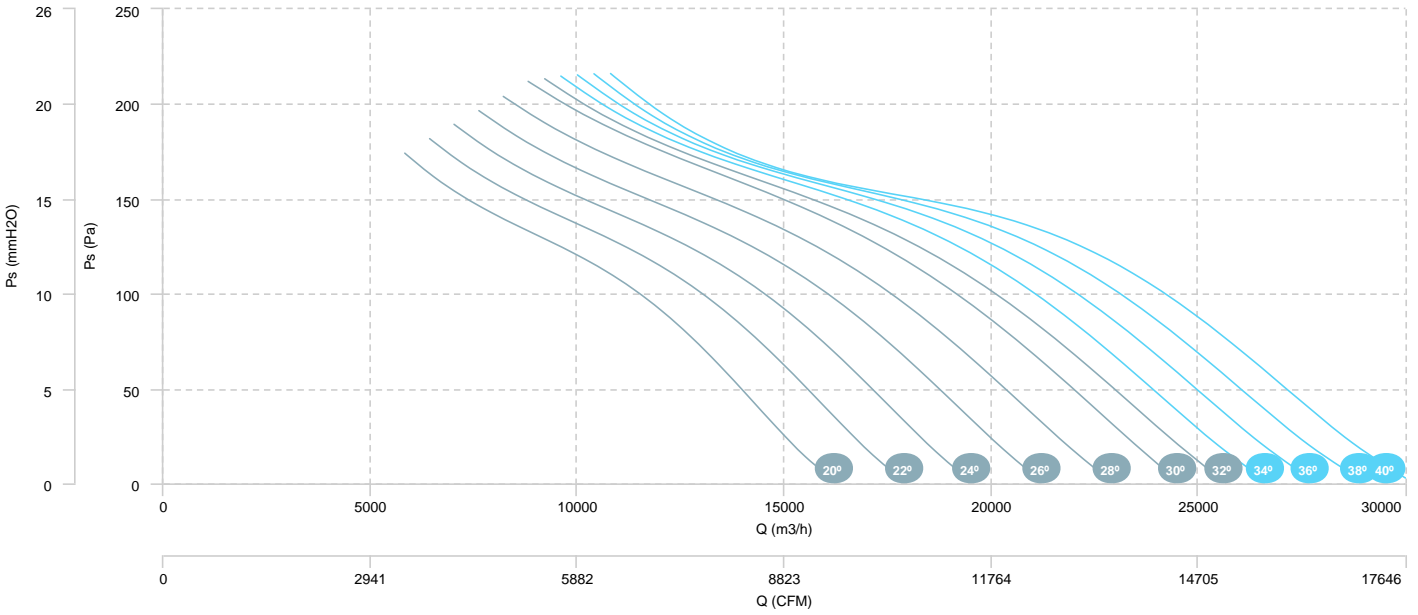

AIR FLOW - ABSORBED POWER

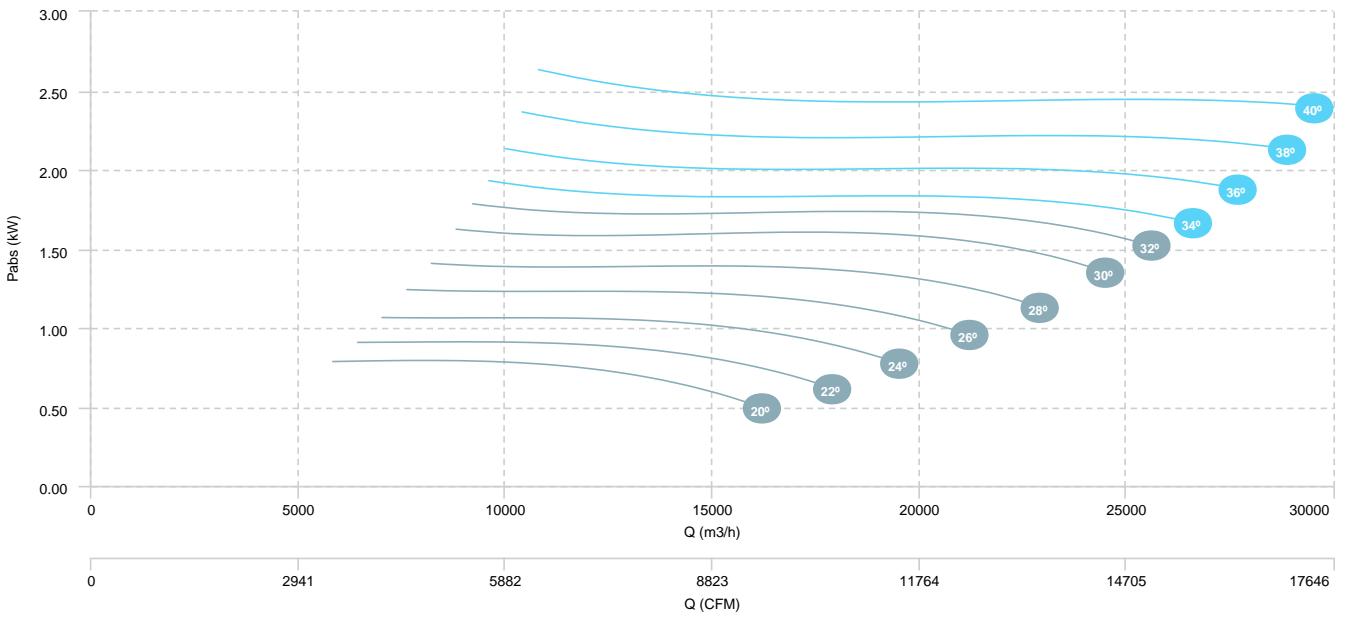

HBFX 90 T4/T8 2,8/0,7kW (A3:4)	HBFX 90 T4/T8 4/0,75kW (A3:4)	HBFX 90 T4/T8 5,5/1,1kW (A3:4)
HBFX 90 T4/T8 7,5/1,5kW (A3:4)	HBFX 90 T4/T8 11/3kW (A3:4)	

**AIR FLOW - PRESSURE (4 poles)**

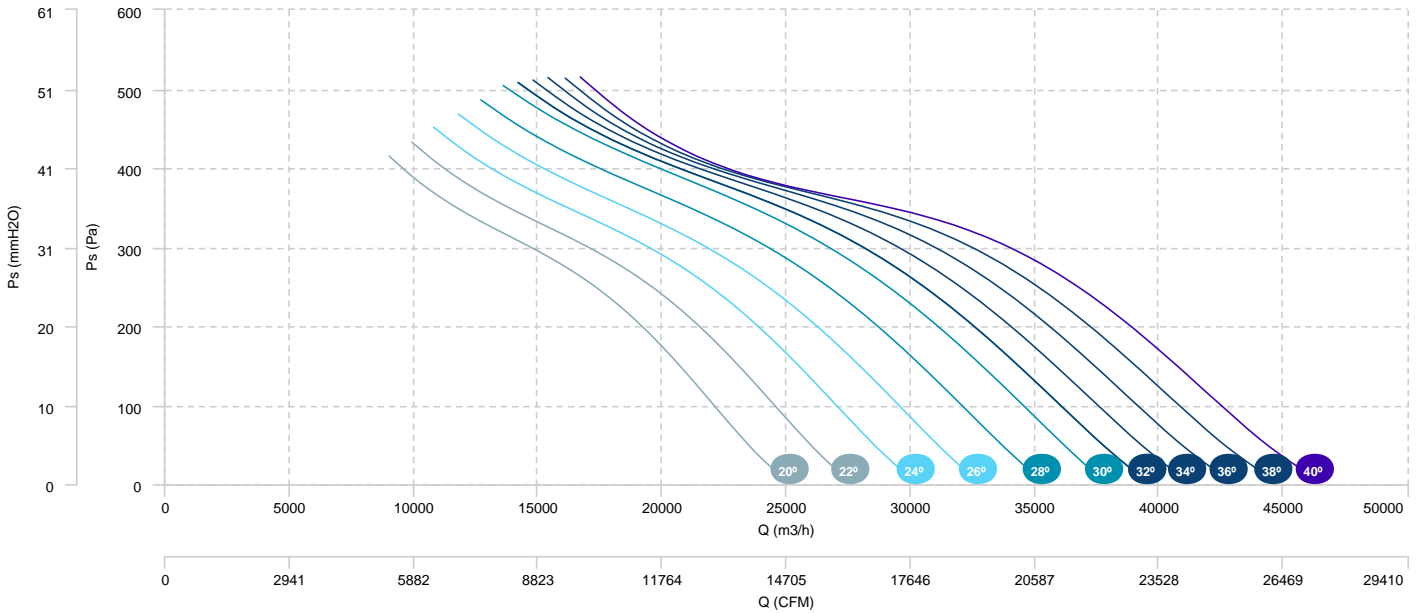

**AIR FLOW - ABSORBED POWER (4 poles)**

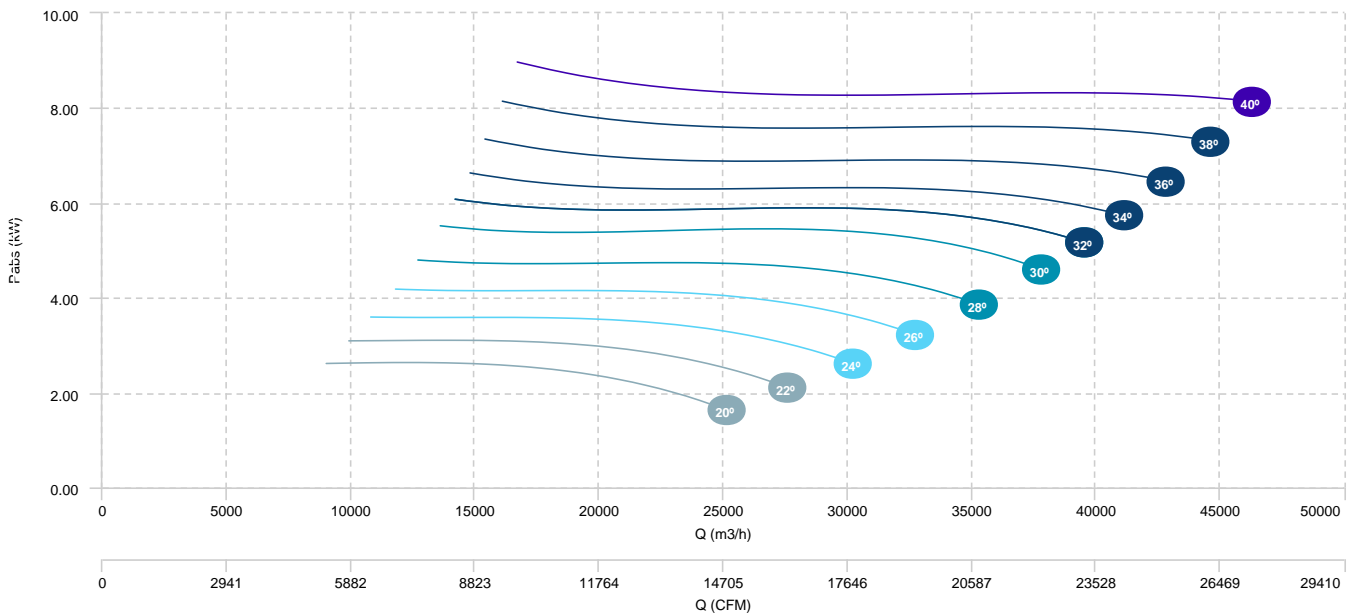



HBFX 90 T4/T8 2,8/0,7kW (A3:4)	HBFX 90 T4/T8 4/0,75kW (A3:4)	HBFX 90 T4/T8 5,5/1,1kW (A3:4)
HBFX 90 T4/T8 7,5/1,5kW (A3:4)	HBFX 90 T4/T8 11/3kW (A3:4)	

**AIR FLOW - PRESSURE (8 poles)**

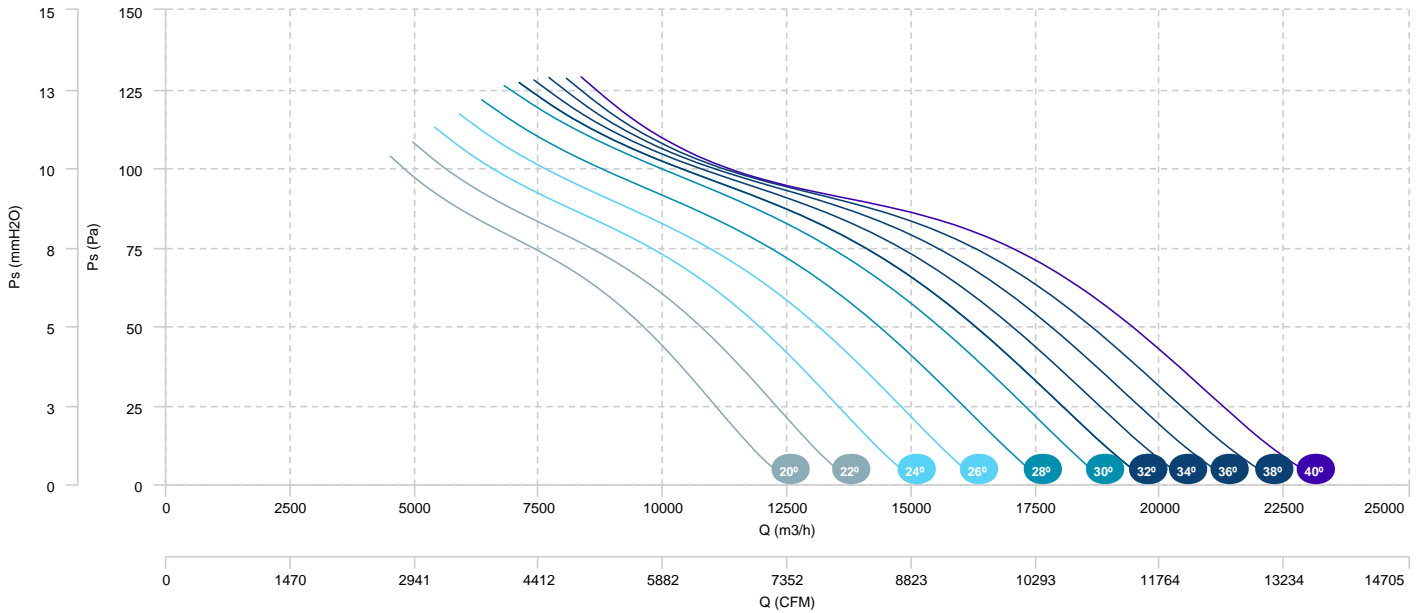

HBFX 90 T4/T8 5,5/1,1kW (A3:8)	HBFX 90 T4/T8 7,5/1,5kW (A3:8)	HBFX 90 T4/T8 11/3kW (A3:8)
HBFX 90 T4/T8 14/3,5kW (A3:8)		

**AIR FLOW - PRESSURE (4 poles)**

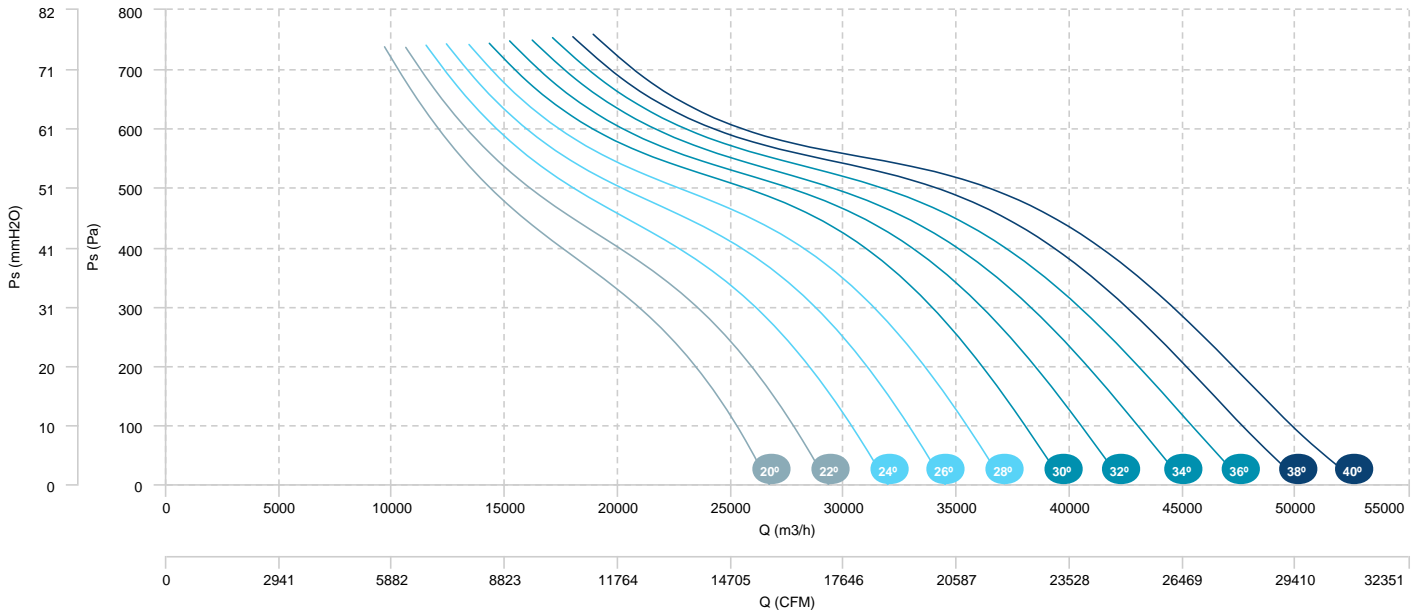

**AIR FLOW - ABSORBED POWER (4 poles)**

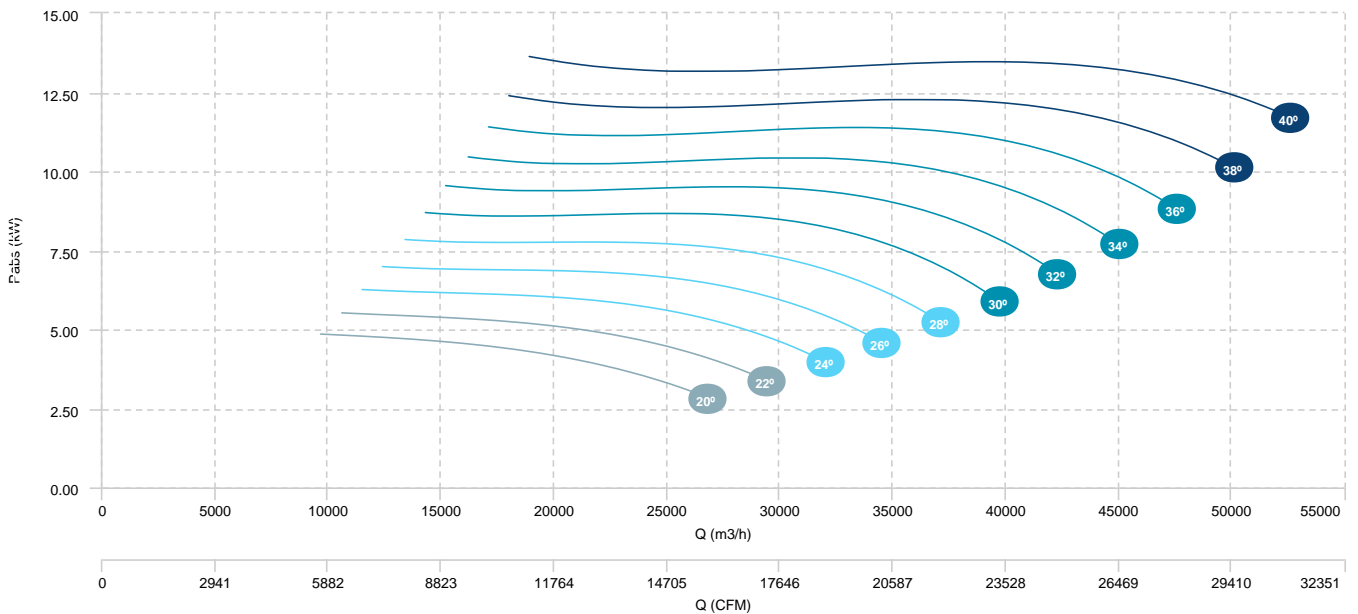

HBFX 90 T4/T8 5,5/1,1kW (A3:8)  
 HBFX 90 T4/T8 14/3,5kW (A3:8)

HBFX 90 T4/T8 7,5/1,5kW (A3:8)

HBFX 90 T4/T8 11/3kW (A3:8)

AIR FLOW - PRESSURE (8 poles)

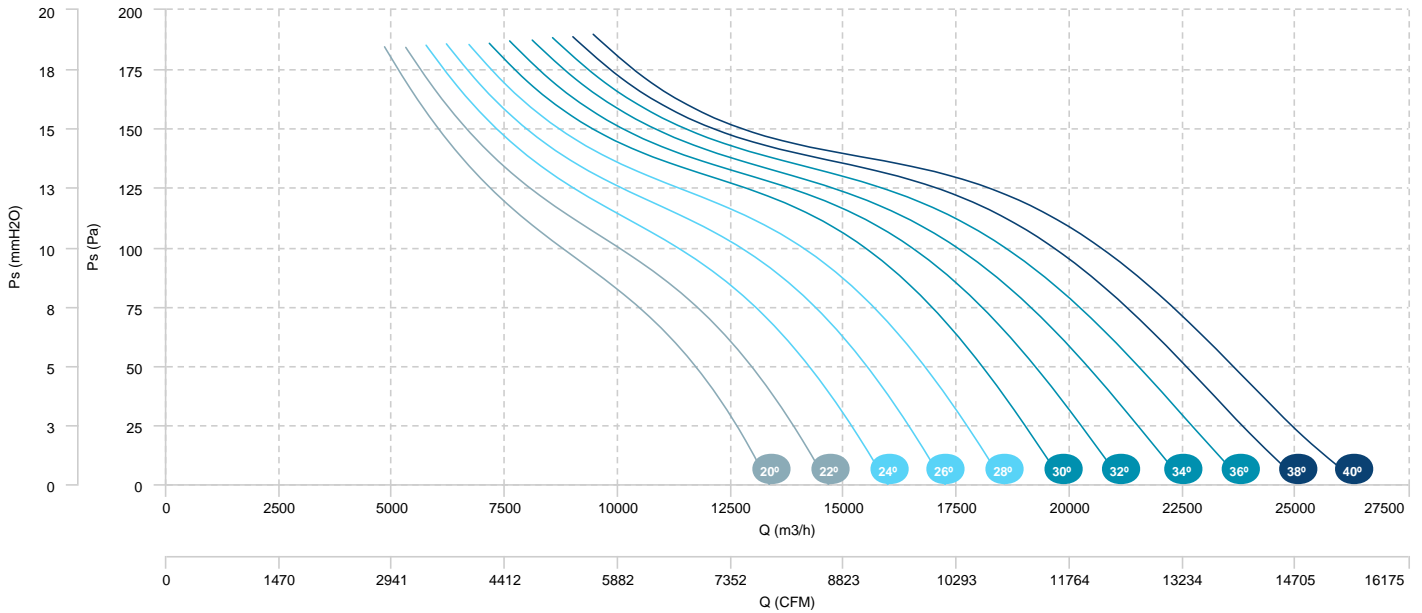

HBFX 100 T4 5,5kW (A3:4)	HBFX 100 T4 7,5kW (A3:4)	HBFX 100 T4 11kW (A3:4)
HBFX 100 T4 15kW (A3:4)		

AIR FLOW - PRESSURE

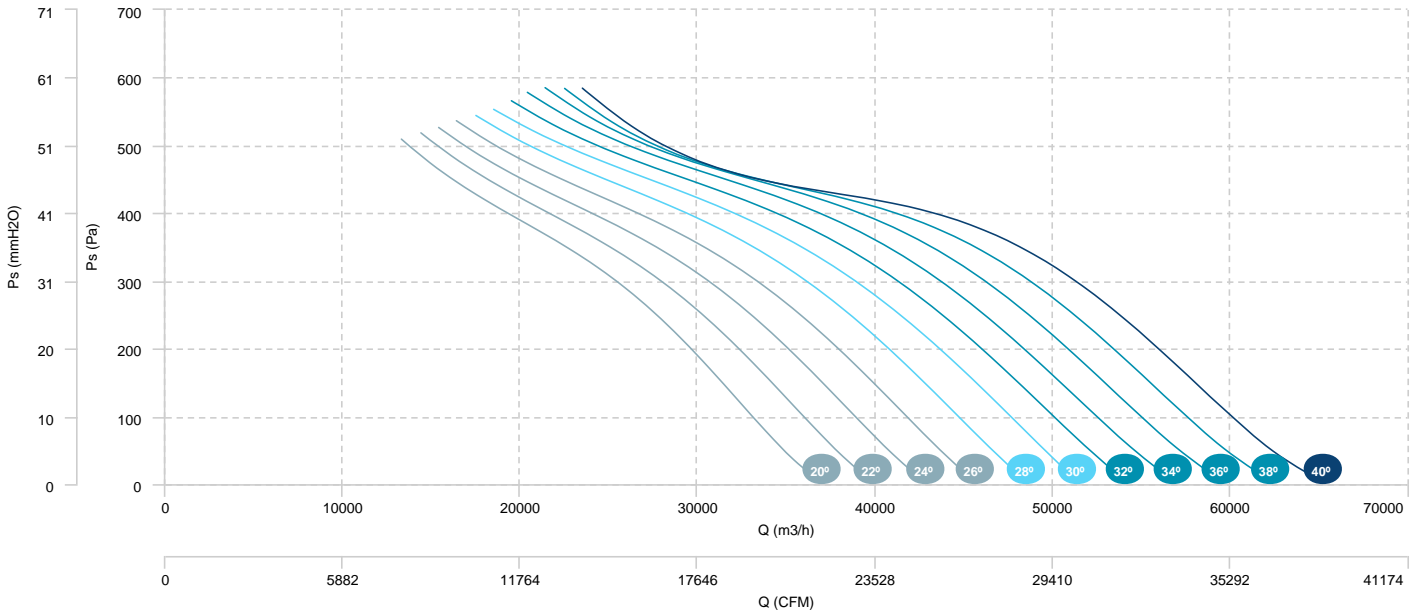

AIR FLOW - ABSORBED POWER

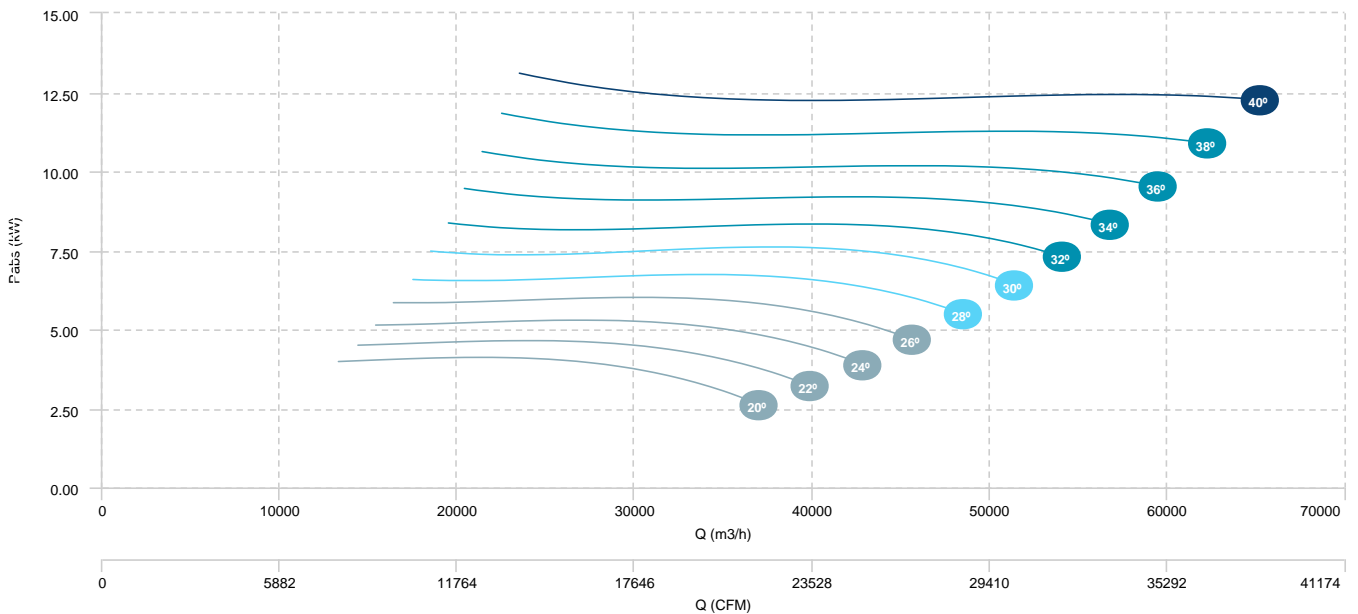

HBFX 100 T4 7,5kW (A3:8)	HBFX 100 T4 11kW (A3:8)	HBFX 100 T4 15kW (A3:8)
HBFX 100 T4 18,5kW (A3:8)	HBFX 100 T4 22kW (A3:8)	

AIR FLOW - PRESSURE

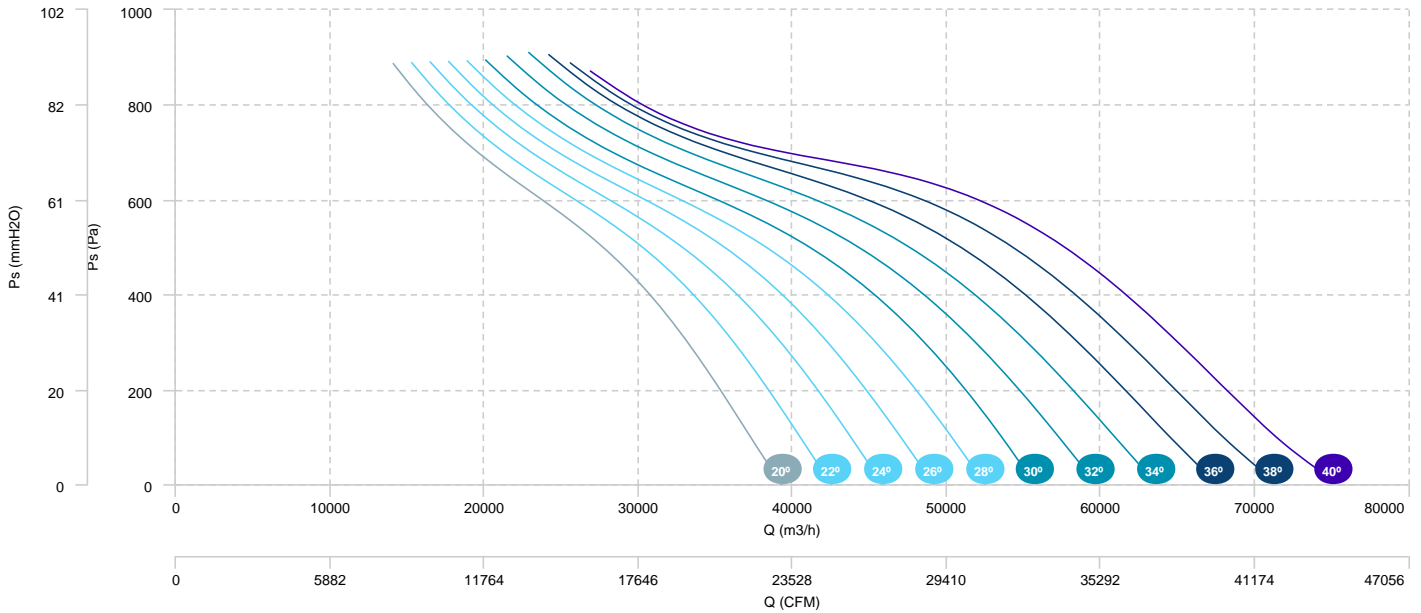

AIR FLOW - ABSORBED POWER

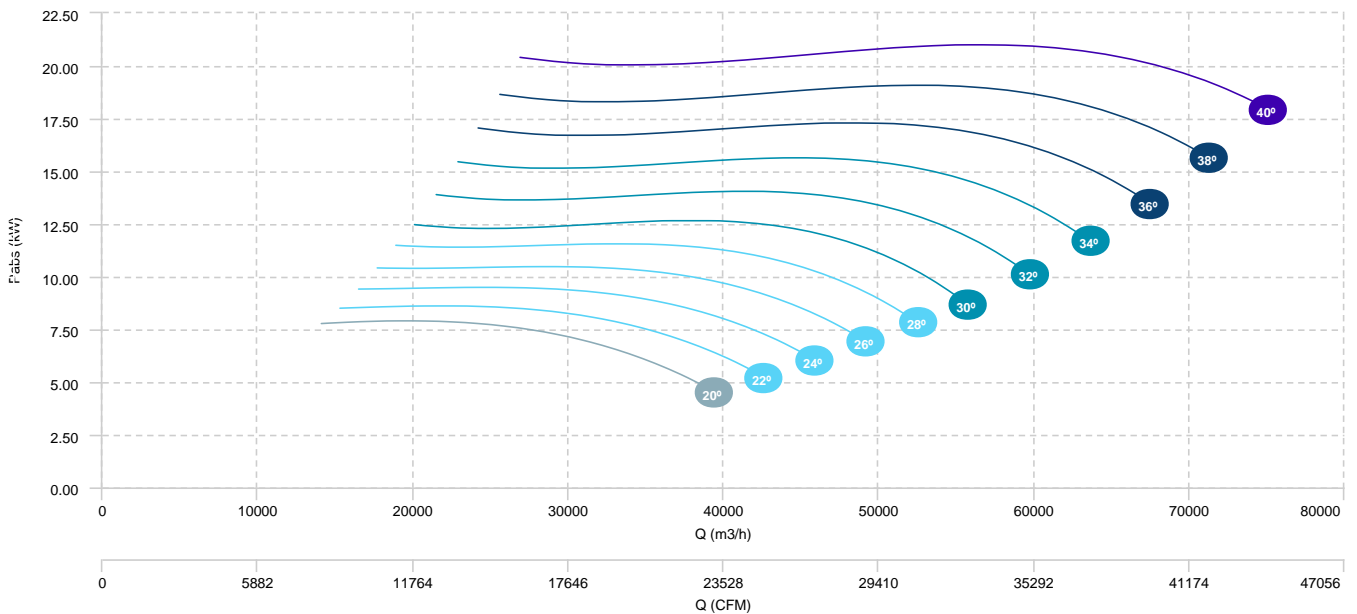

HBFX 100 T6 1,5kW (A3:4)	HBFX 100 T6 2,2kW (A3:4)	HBFX 100 T6 3kW (A3:4)
HBFX 100 T6 4kW (A3:4)		

**AIR FLOW - PRESSURE**

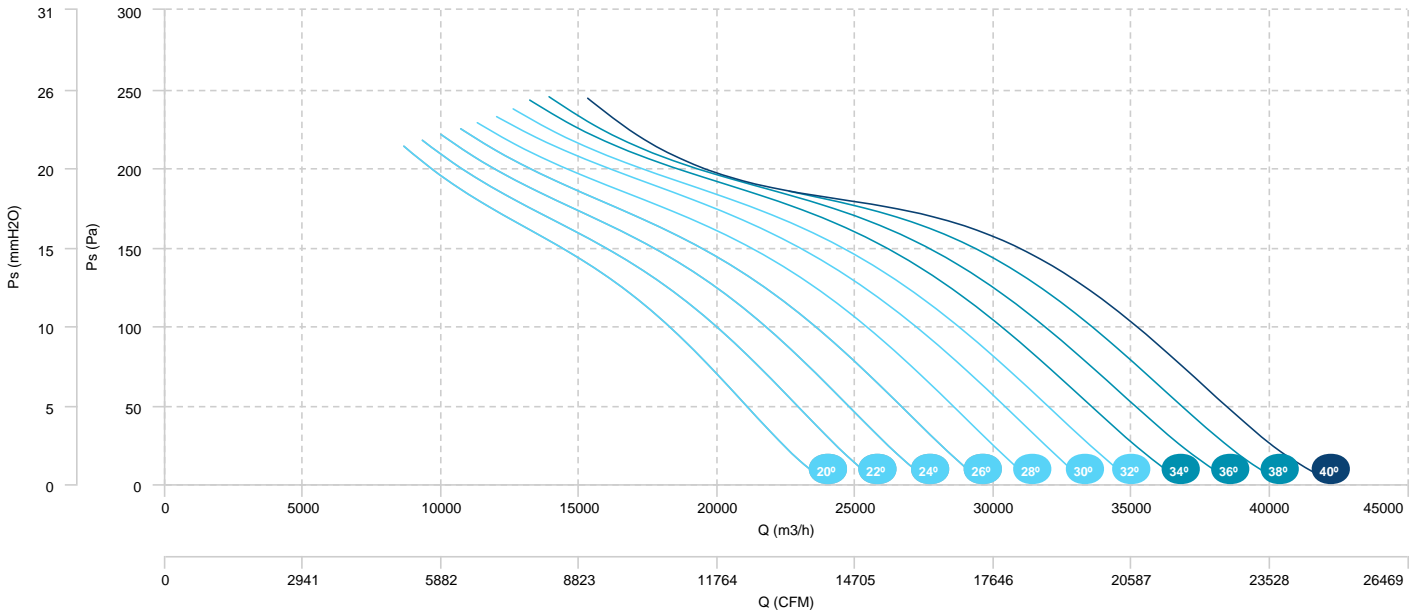

**AIR FLOW - ABSORBED POWER**

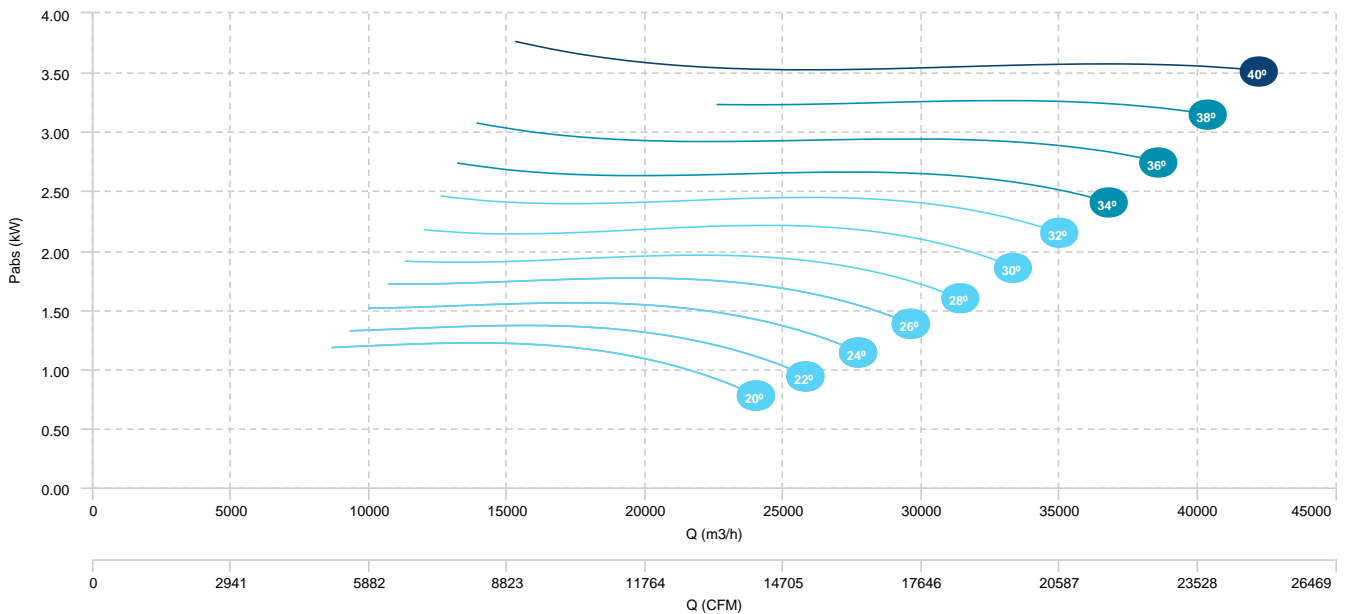

HBFX 100 T6 2,2kW (A3:8)	HBFX 100 T6 3kW (A3:8)	HBFX 100 T6 4kW (A3:8)
HBFX 100 T6 5,5kW (A3:8)		

AIR FLOW - PRESSURE

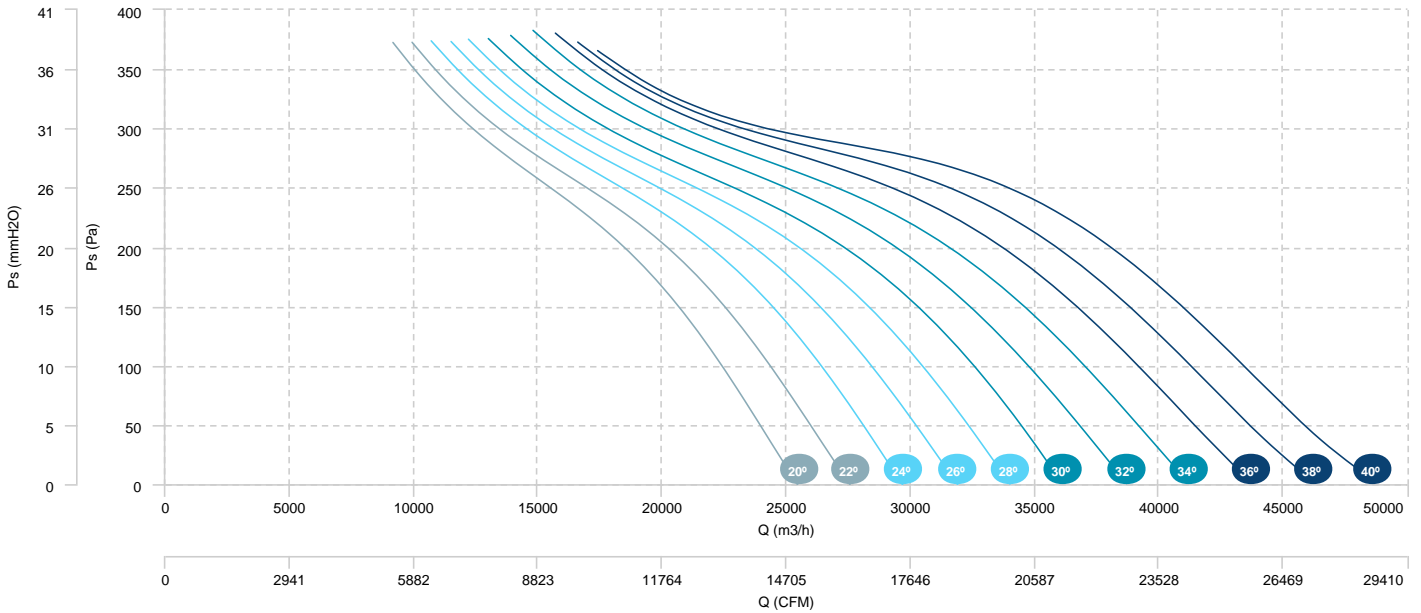

AIR FLOW - ABSORBED POWER

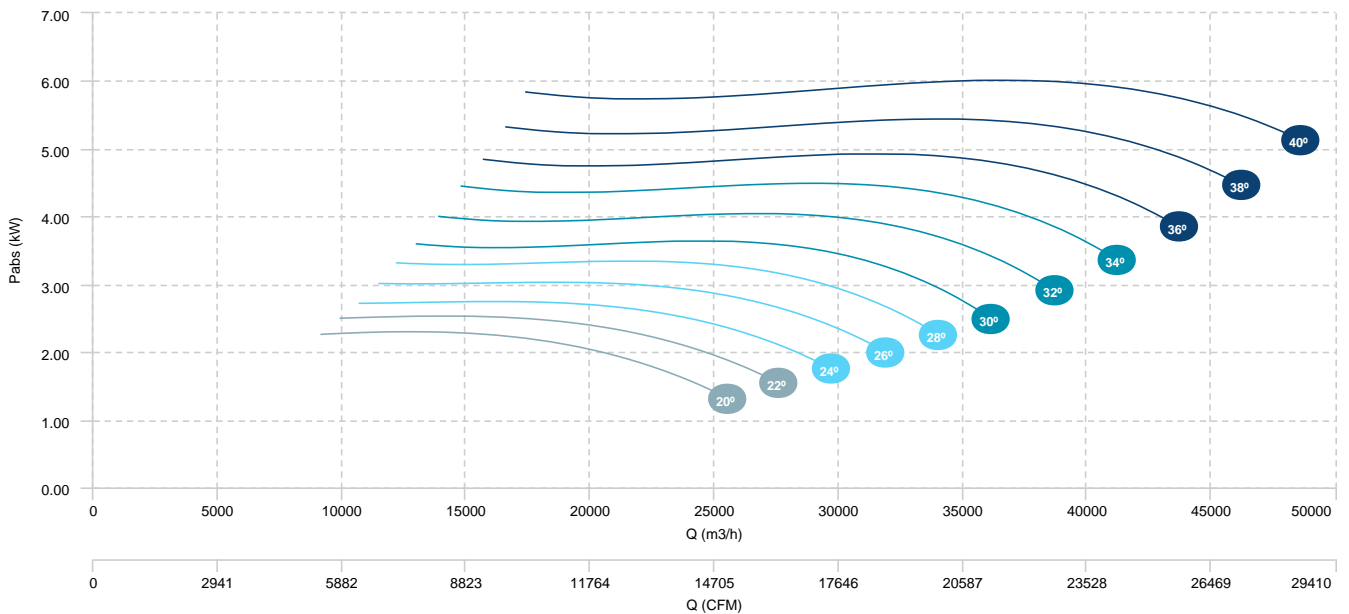

HBFX 100 T4/T8 5,5/1,1kW (A3:4)	HBFX 100 T4/T8 7,5/1,5kW (A3:4)	HBFX 100 T4/T8 11/3kW (A3:4)
HBFX 100 T4/T8 14/3,5kW (A3:4)		

**AIR FLOW - PRESSURE (4 poles)**

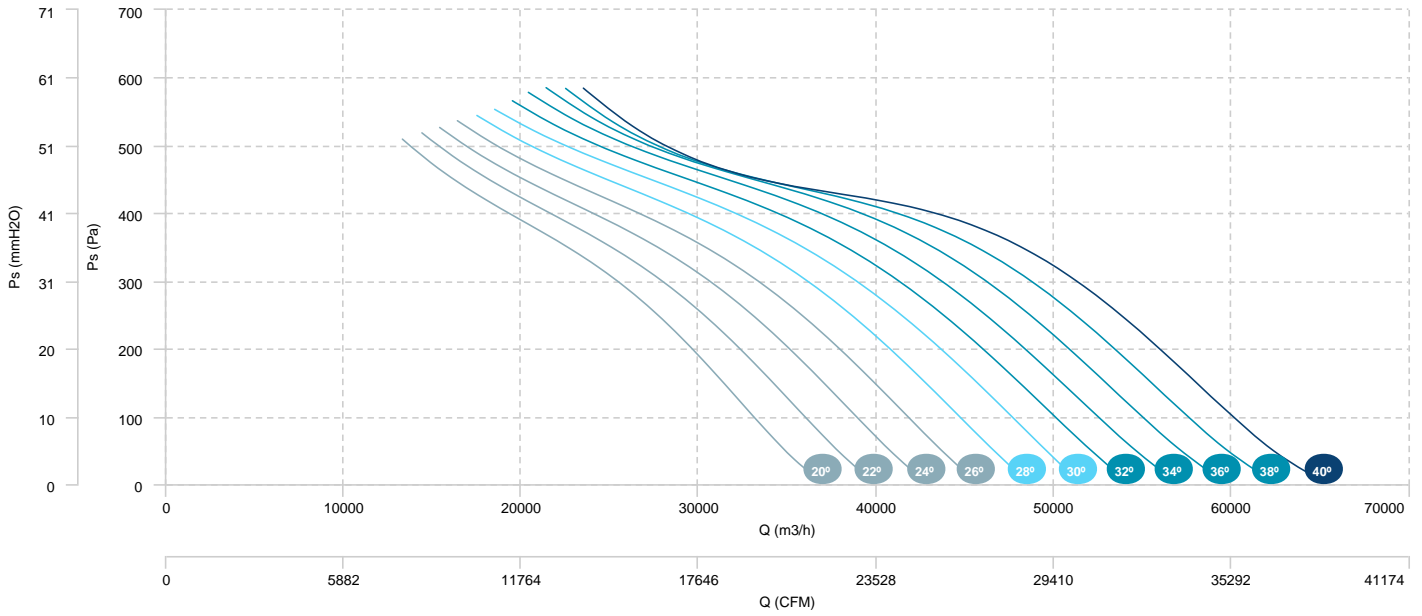

**AIR FLOW - ABSORBED POWER (4 poles)**

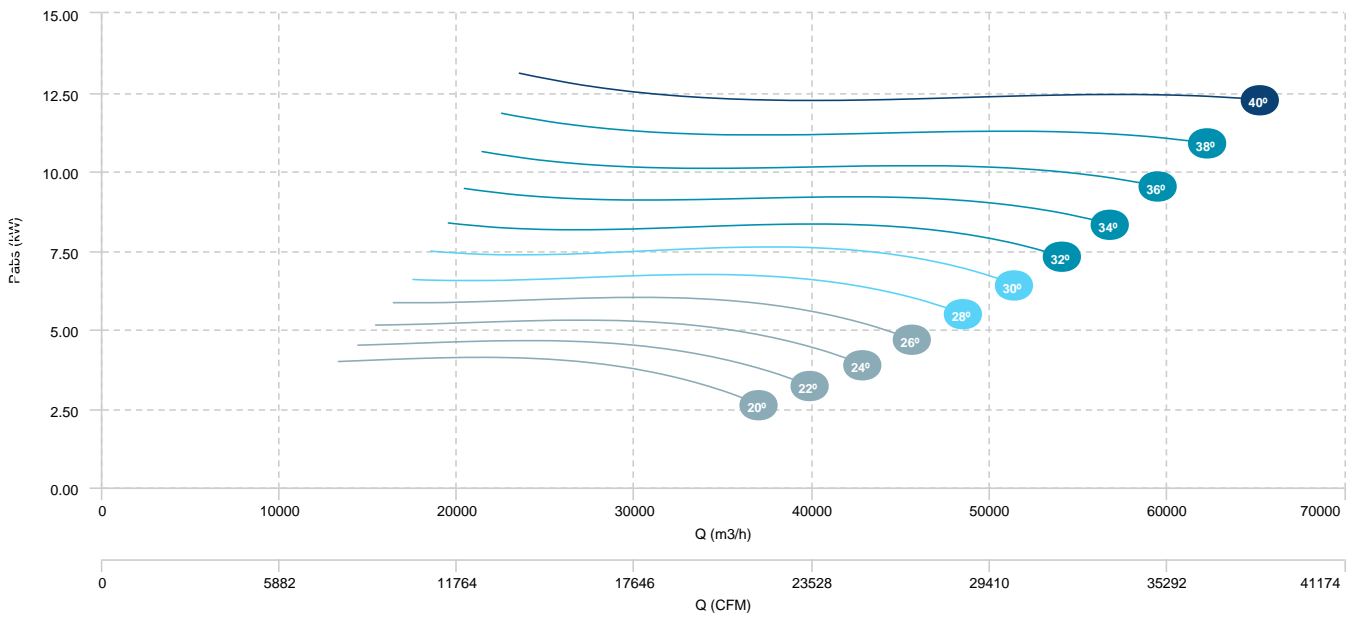



- HBFX 100 T4/T8 5,5/1,1kW (A3:4)
- HBFX 100 T4/T8 7,5/1,5kW (A3:4)
- HBFX 100 T4/T8 11/3kW (A3:4)
- HBFX 100 T4/T8 14/3,5kW (A3:4)

**AIR FLOW - PRESSURE (8 poles)**

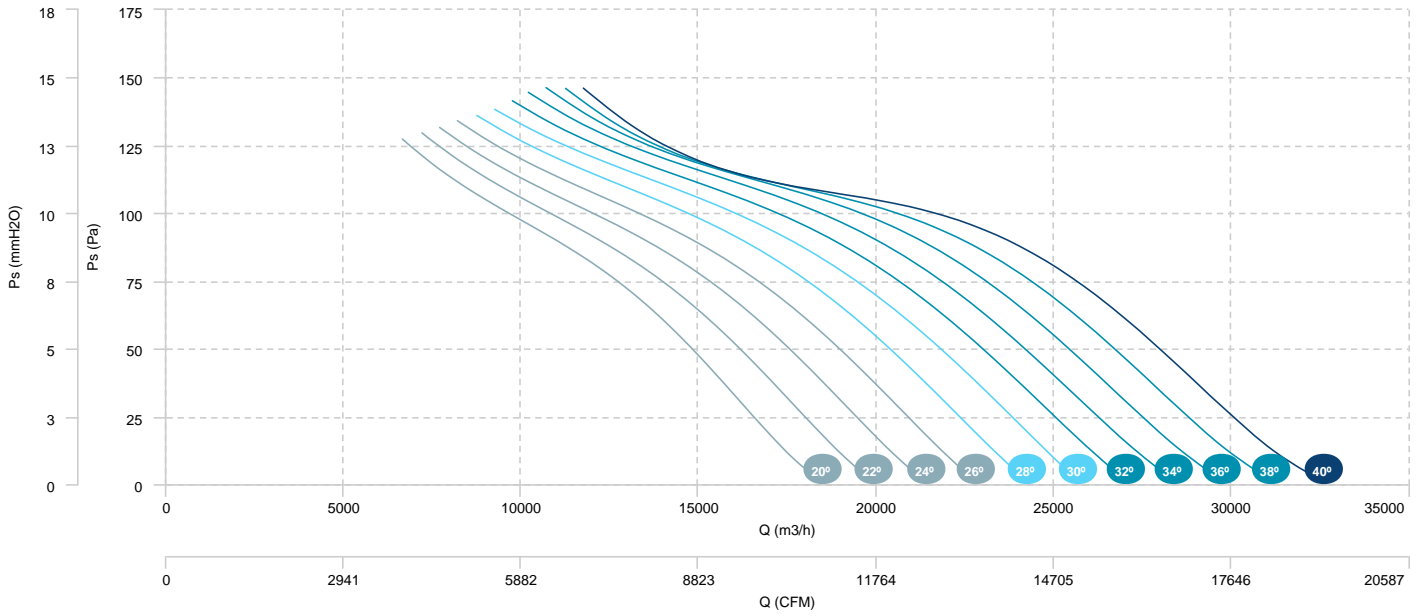

HBFX 100 T4/T8 7,5/1,5kW (A3:8)	HBFX 100 T4/T8 11/3kW (A3:8)	HBFX 100 T4/T8 14/3,5kW (A3:8)
HBFX 100 T4/T8 17/4,3kW (A3:8)	HBFX 100 T4/T8 20/5kW (A3:8)	

**AIR FLOW - PRESSURE (4 poles)**

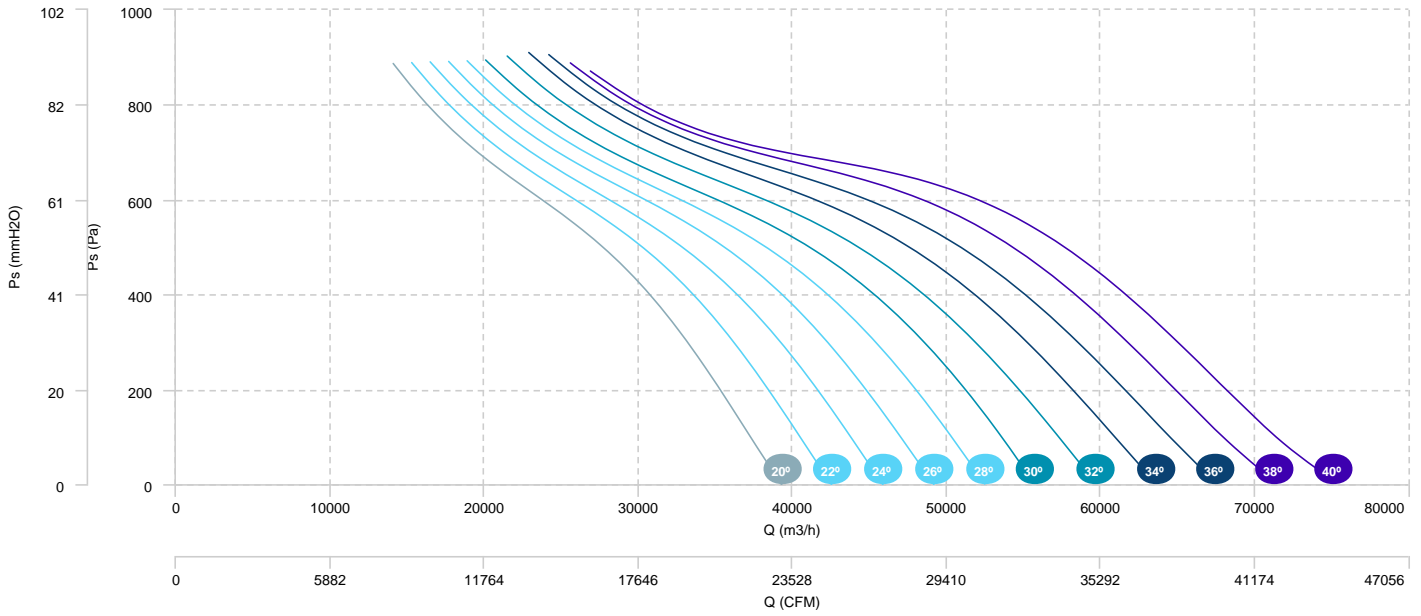

**AIR FLOW - ABSORBED POWER (4 poles)**

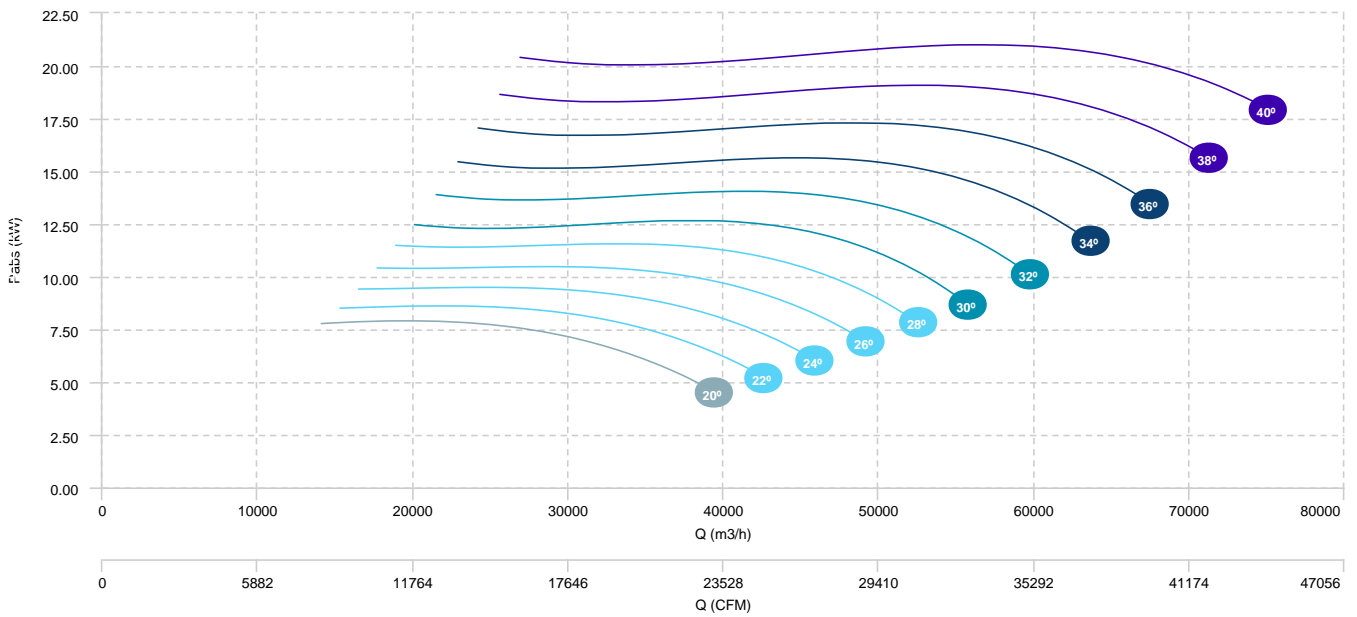

HBFX 100 T4/T8 7,5/1,5kW (A3:8)	HBFX 100 T4/T8 11/3kW (A3:8)	HBFX 100 T4/T8 14/3,5kW (A3:8)
HBFX 100 T4/T8 17/4,3kW (A3:8)	HBFX 100 T4/T8 20/5kW (A3:8)	

**AIR FLOW - PRESSURE (8 poles)**

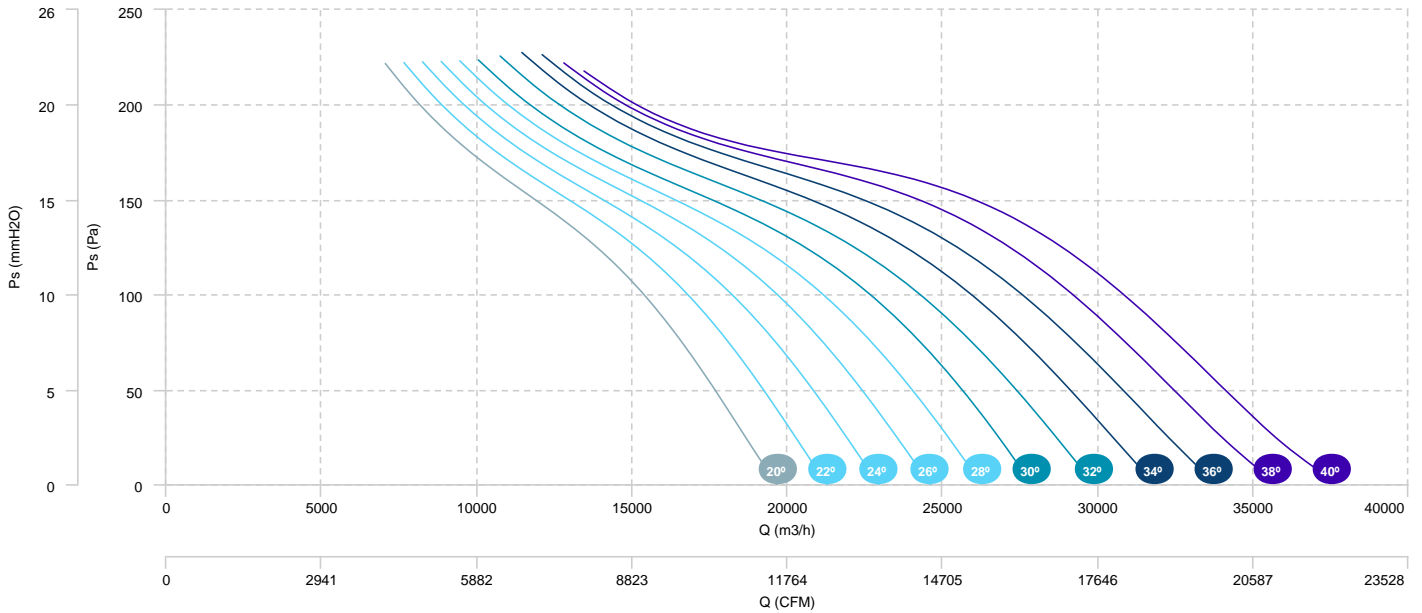

HBFX 112 T4 11kW (A3:8)	HBFX 112 T4 15kW (A3:8)	HBFX 112 T4 18,5kW (A3:8)
HBFX 112 T4 22kW (A3:8)	HBFX 112 T4 30kW (A3:8)	

**AIR FLOW - PRESSURE**

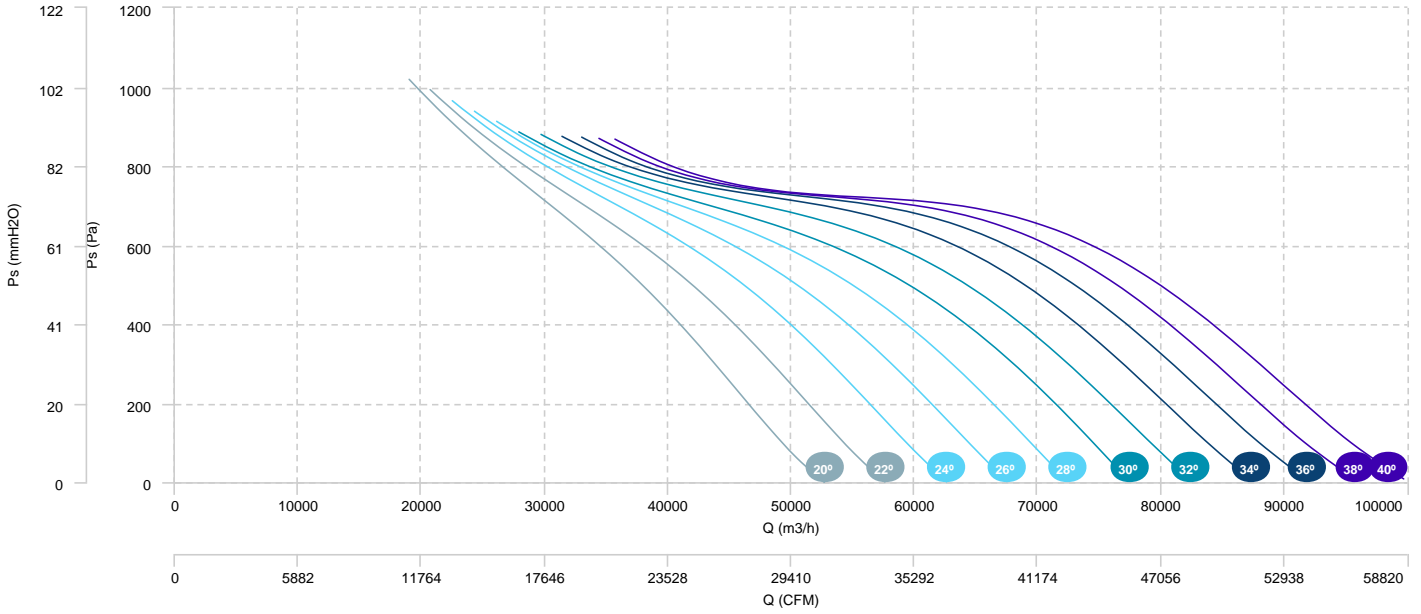

**AIR FLOW - ABSORBED POWER**

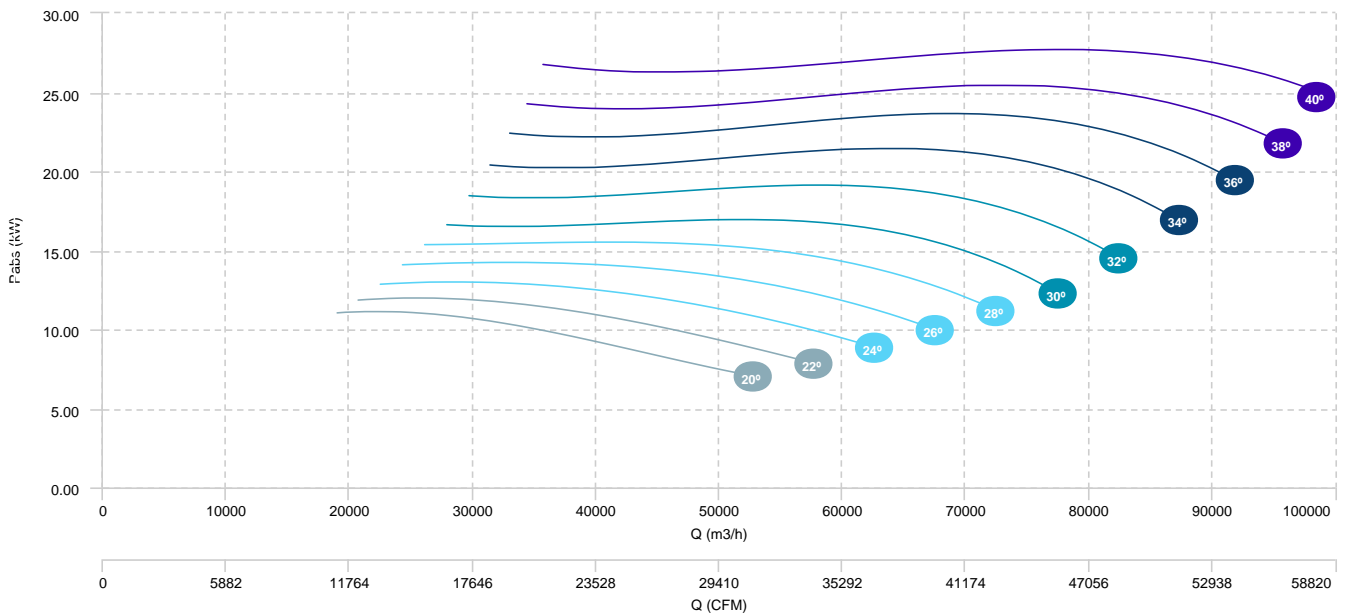

HBFX 112 T4 5,5kW (A3:4)	HBFX 112 T4 7,5kW (A3:4)	HBFX 112 T4 11kW (A3:4)
HBFX 112 T4 15kW (A3:4)	HBFX 112 T4 18,5kW (A3:4)	

**AIR FLOW - PRESSURE**

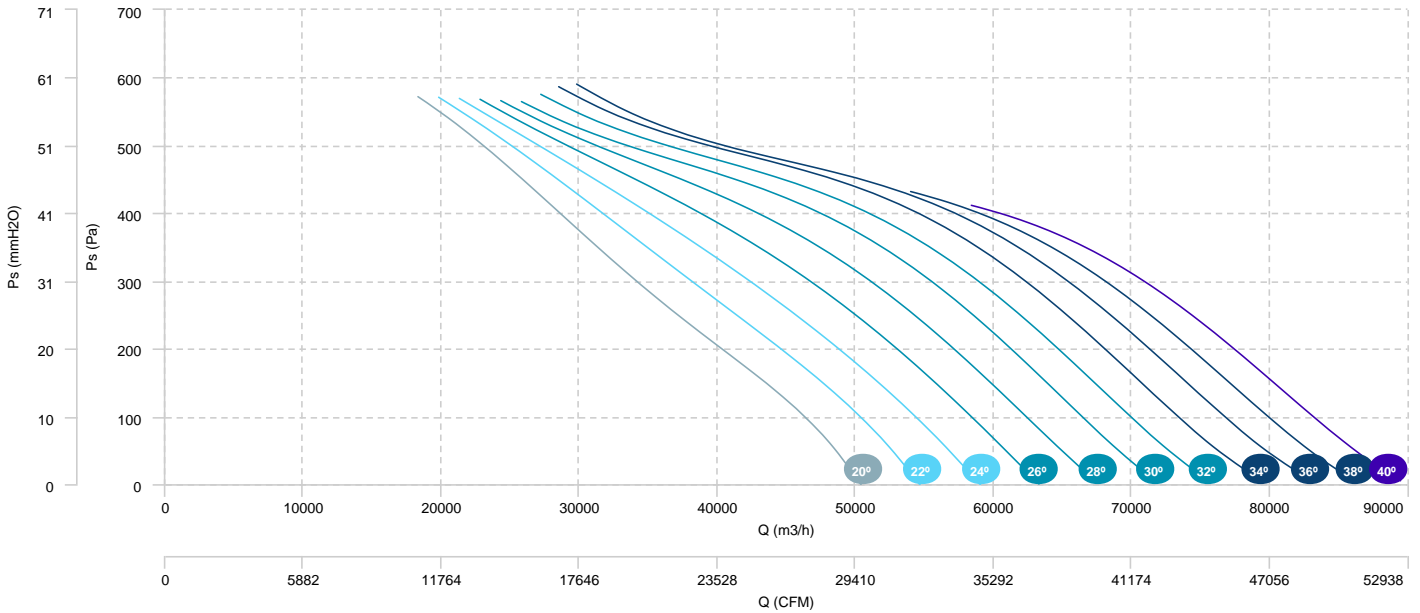

**AIR FLOW - ABSORBED POWER**

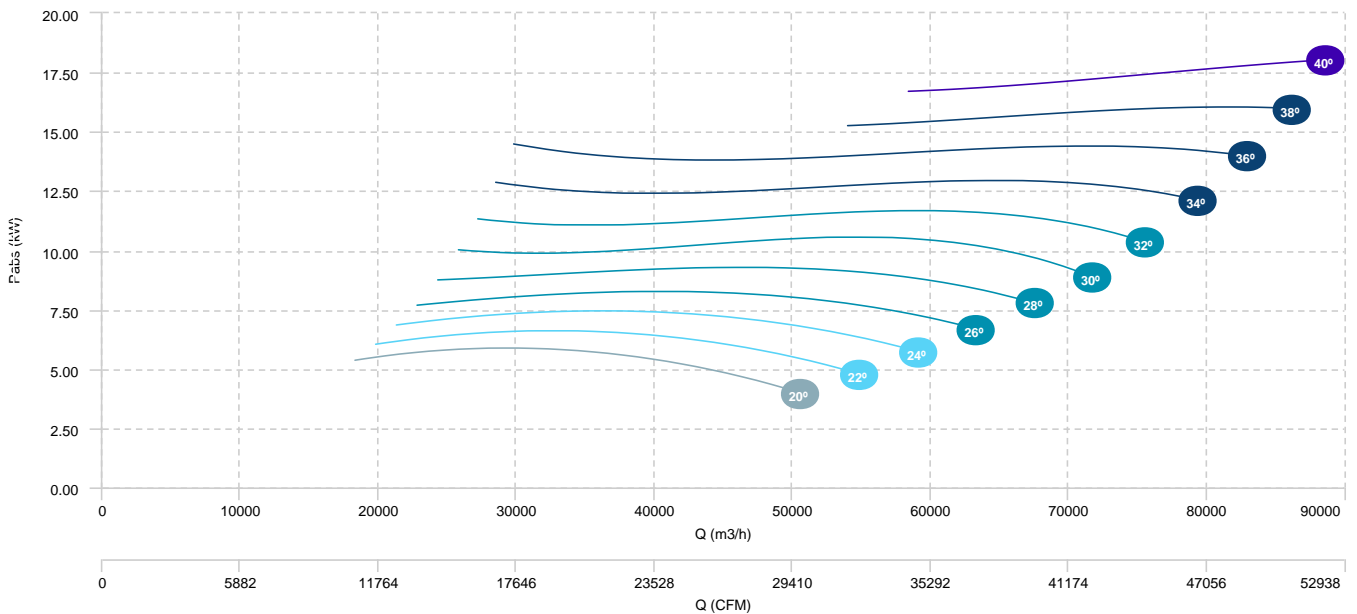

HBFX 112 T6 2,2kW (A3:4)	HBFX 112 T6 3kW (A3:4)	HBFX 112 T6 4kW (A3:4)
HBFX 112 T6 5,5kW (A3:4)		

AIR FLOW - PRESSURE

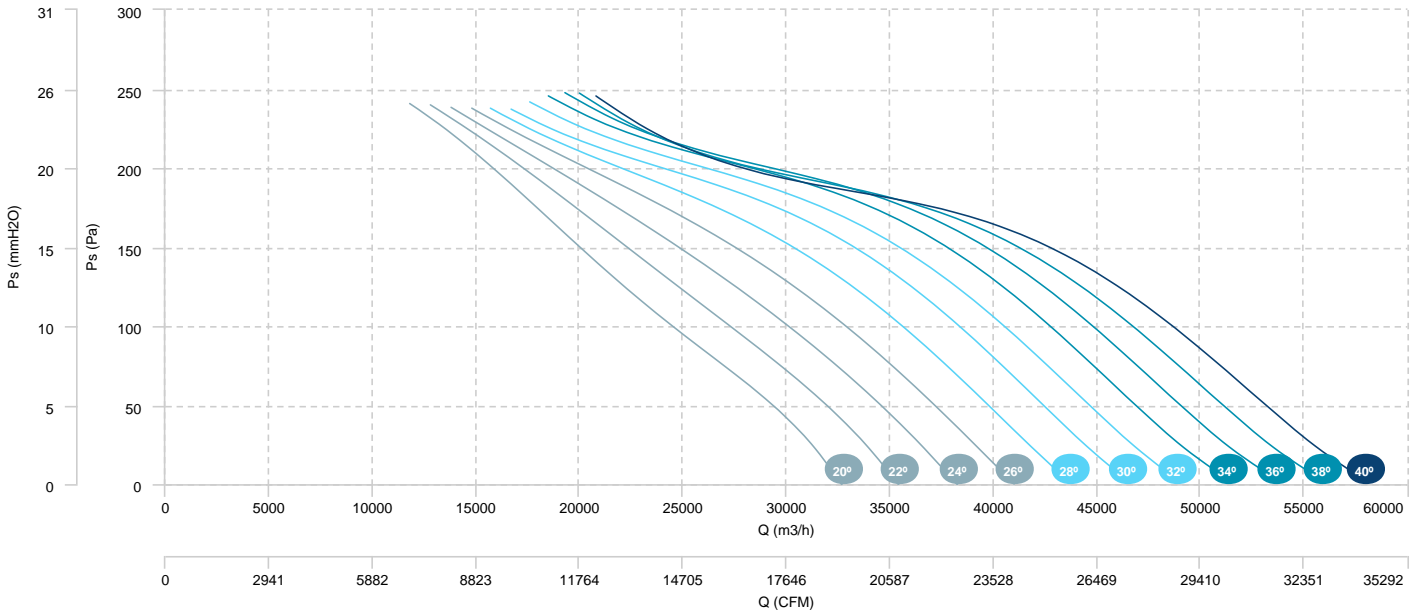

AIR FLOW - ABSORBED POWER

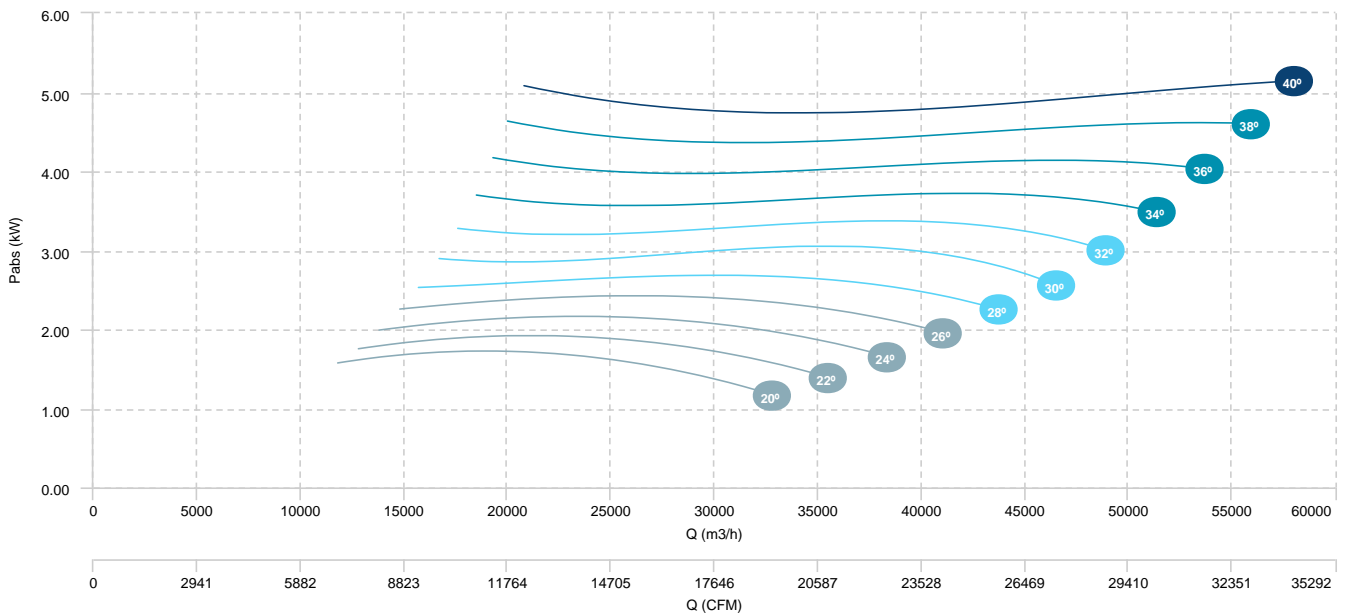

HBFX 112 T6 3kW (A3:8)	HBFX 112 T6 4kW (A3:8)	HBFX 112 T6 5,5kW (A3:8)
HBFX 112 T6 7,5kW (A3:8)		

AIR FLOW - PRESSURE

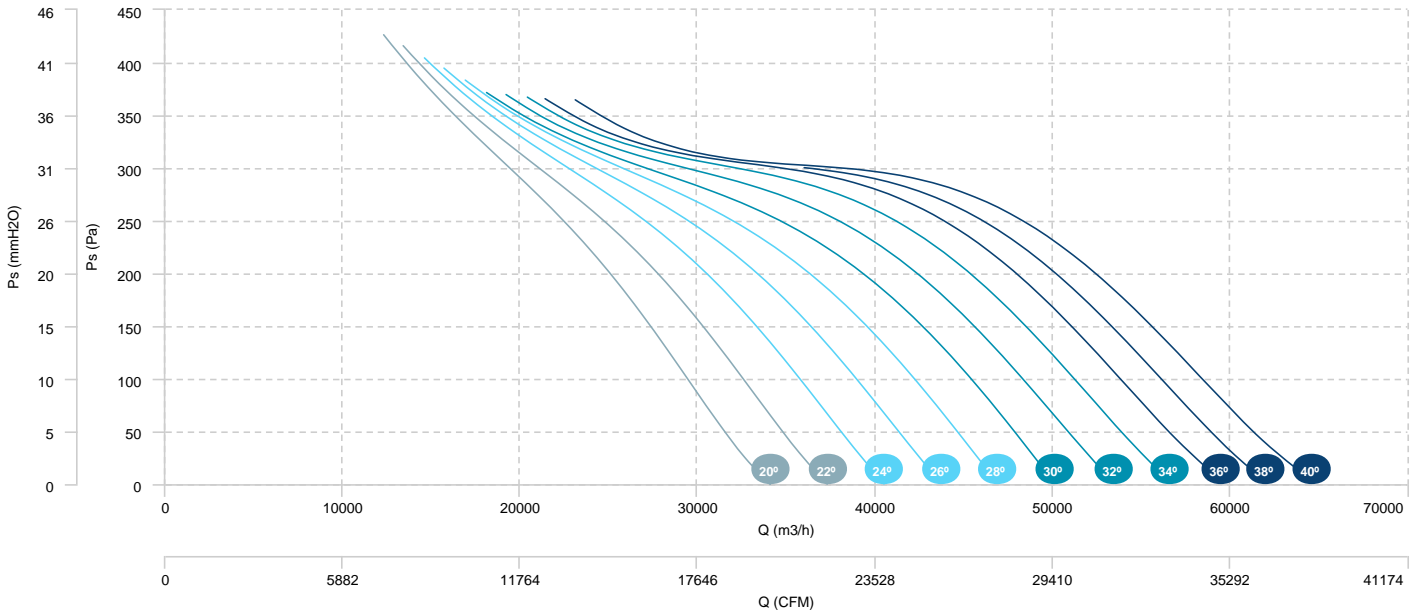

AIR FLOW - ABSORBED POWER

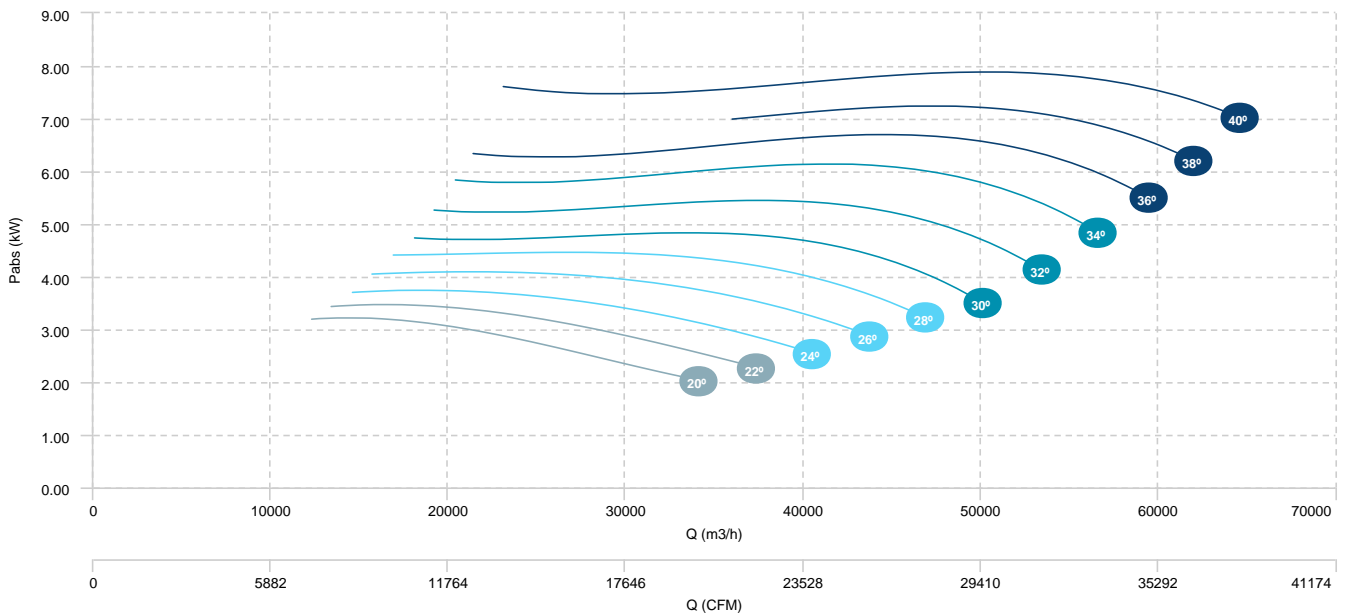

HBFX 112 T4/T8 5,5/1,1kW (A3:4)	HBFX 112 T4/T8 7,5/1,5kW (A3:4)	HBFX 112 T4/T8 11/3kW (A3:4)
HBFX 112 T4/T8 14/3,5kW (A3:4)	HBFX 112 T4/T8 17/4,3kW (A3:4)	

**AIR FLOW - PRESSURE (4 poles)**

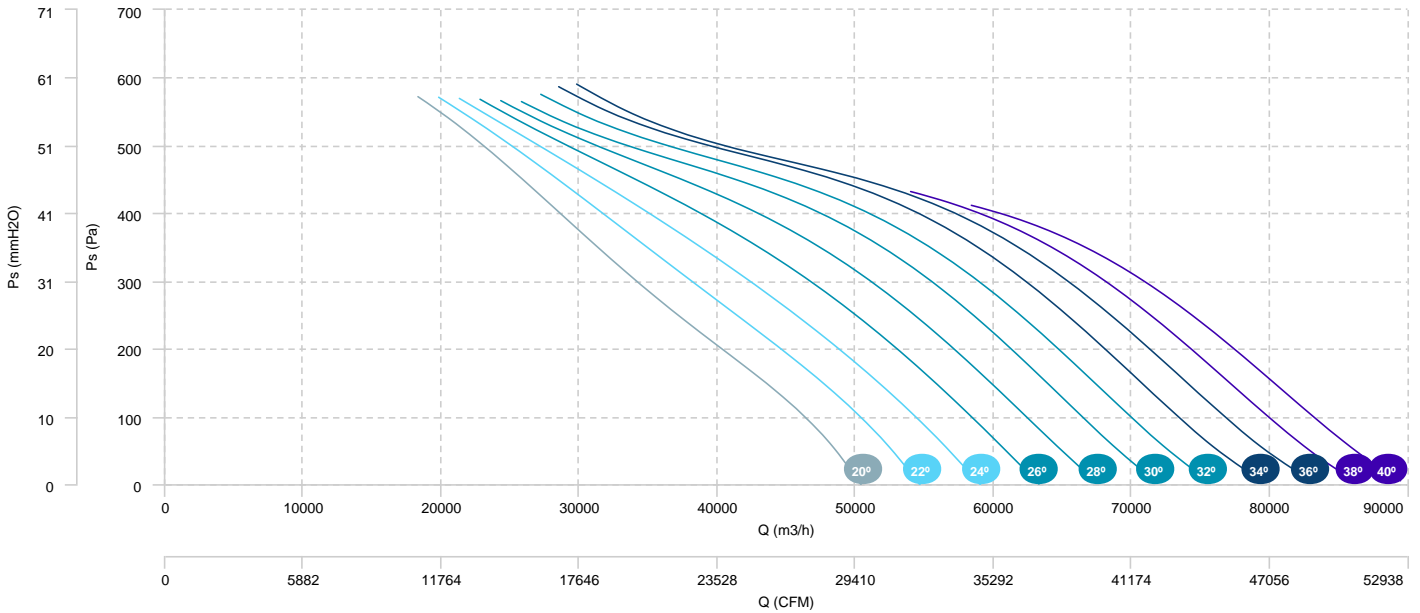

**AIR FLOW - ABSORBED POWER (4 poles)**

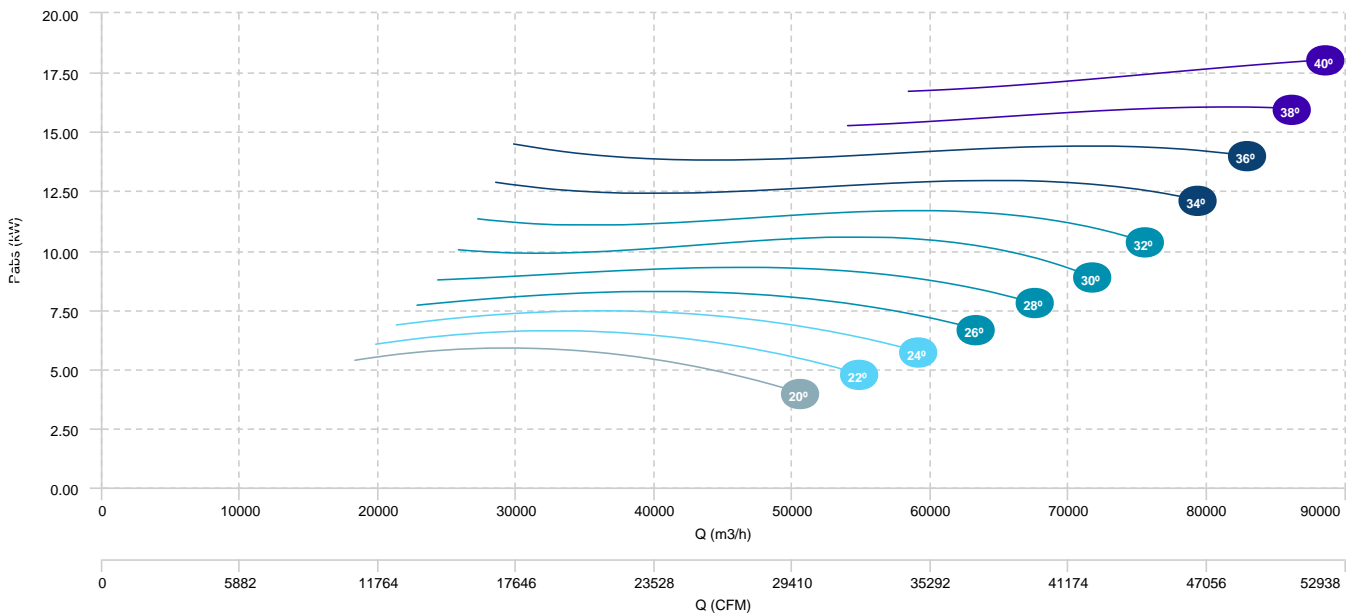



HBFX 112 T4/T8 5,5/1,1kW (A3:4)	HBFX 112 T4/T8 7,5/1,5kW (A3:4)	HBFX 112 T4/T8 11/3kW (A3:4)
HBFX 112 T4/T8 14/3,5kW (A3:4)	HBFX 112 T4/T8 17/4,3kW (A3:4)	

AIR FLOW - PRESSURE (8 poles)

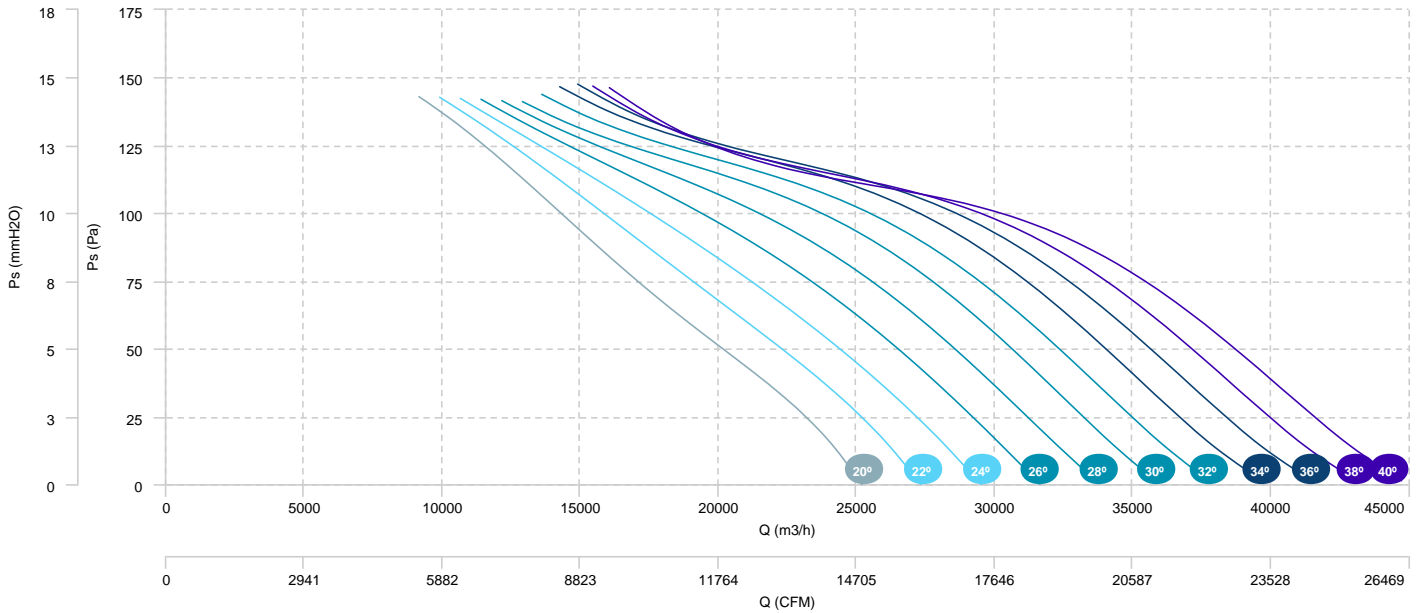

HBFX 112 T4/T8 11/3kW (A3:8)	HBFX 112 T4/T8 14/3,5kW (A3:8)	HBFX 112 T4/T8 17/4,3kW (A3:8)
HBFX 112 T4/T8 20/5kW (A3:8)	HBFX 112 T4/T8 28/6,5kW (A3:8)	

**AIR FLOW - PRESSURE (4 poles)**

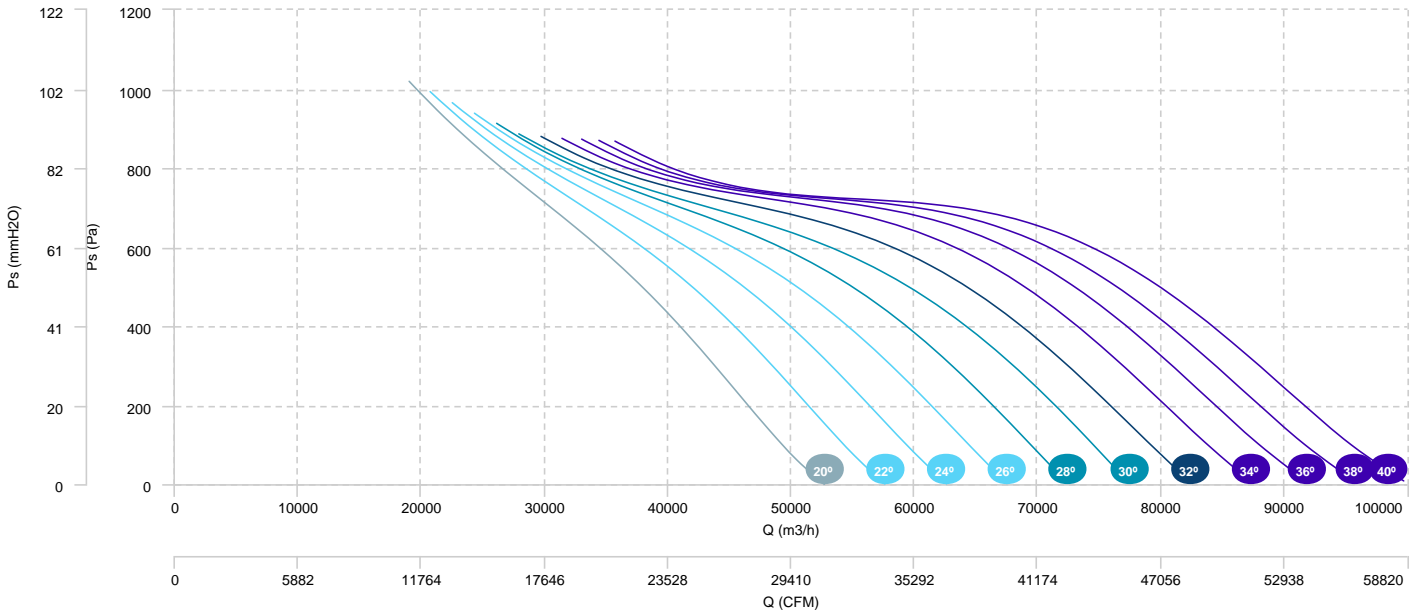

**AIR FLOW - ABSORBED POWER (4 poles)**

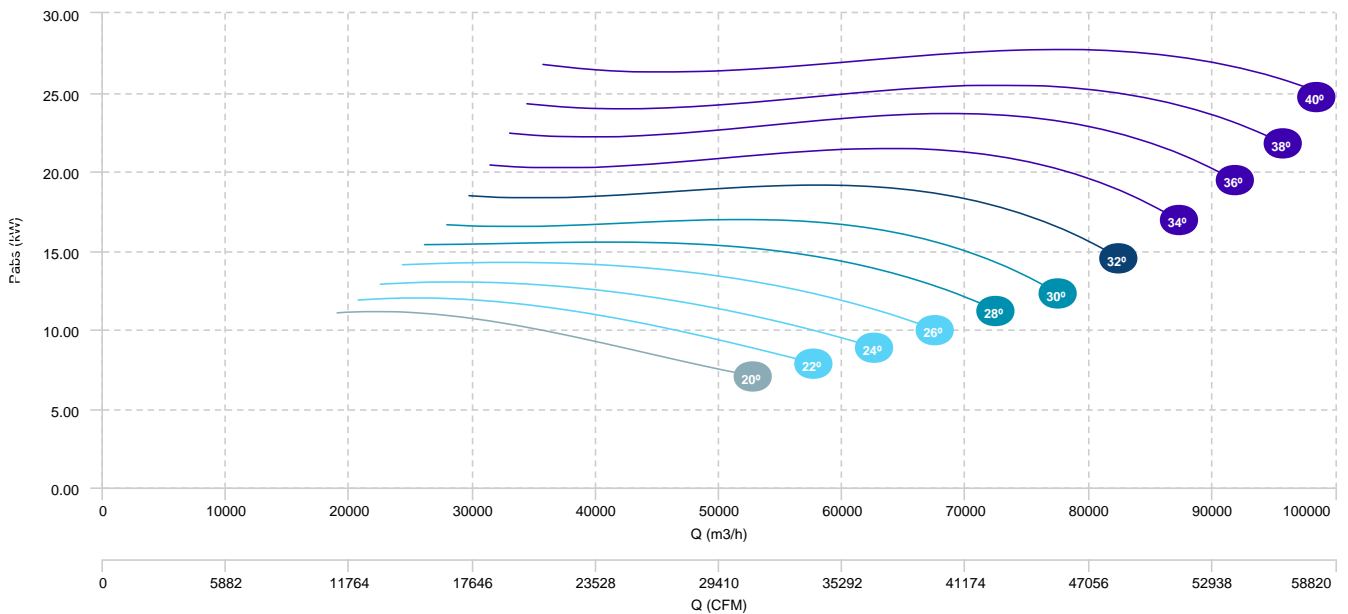

HBFX 112 T4/T8 11/3kW (A3:8)	HBFX 112 T4/T8 14/3,5kW (A3:8)	HBFX 112 T4/T8 17/4,3kW (A3:8)
HBFX 112 T4/T8 20/5kW (A3:8)	HBFX 112 T4/T8 28/6,5kW (A3:8)	

**AIR FLOW - PRESSURE (8 poles)**

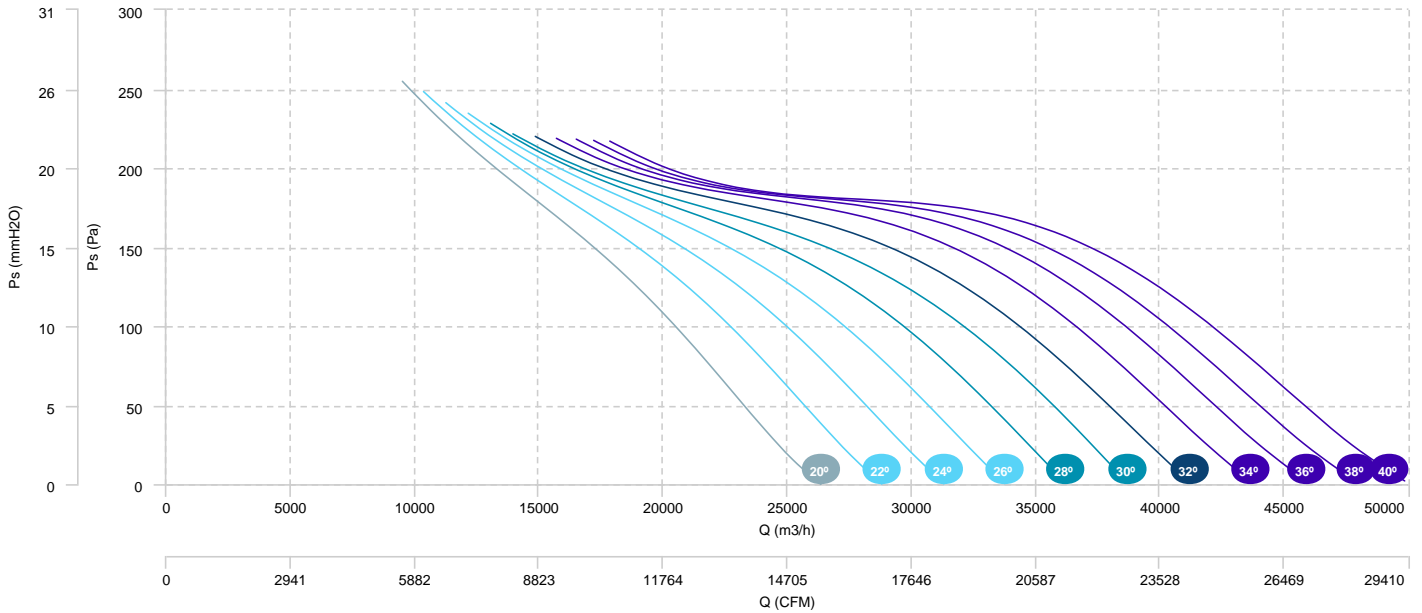

HBFX 125 T4 11kW (A3:4)	HBFX 125 T4 15kW (A3:4)	HBFX 125 T4 18,5kW (A3:4)
HBFX 125 T4 22kW (A3:4)	HBFX 125 T4 30kW (A3:4)	

AIR FLOW - PRESSURE

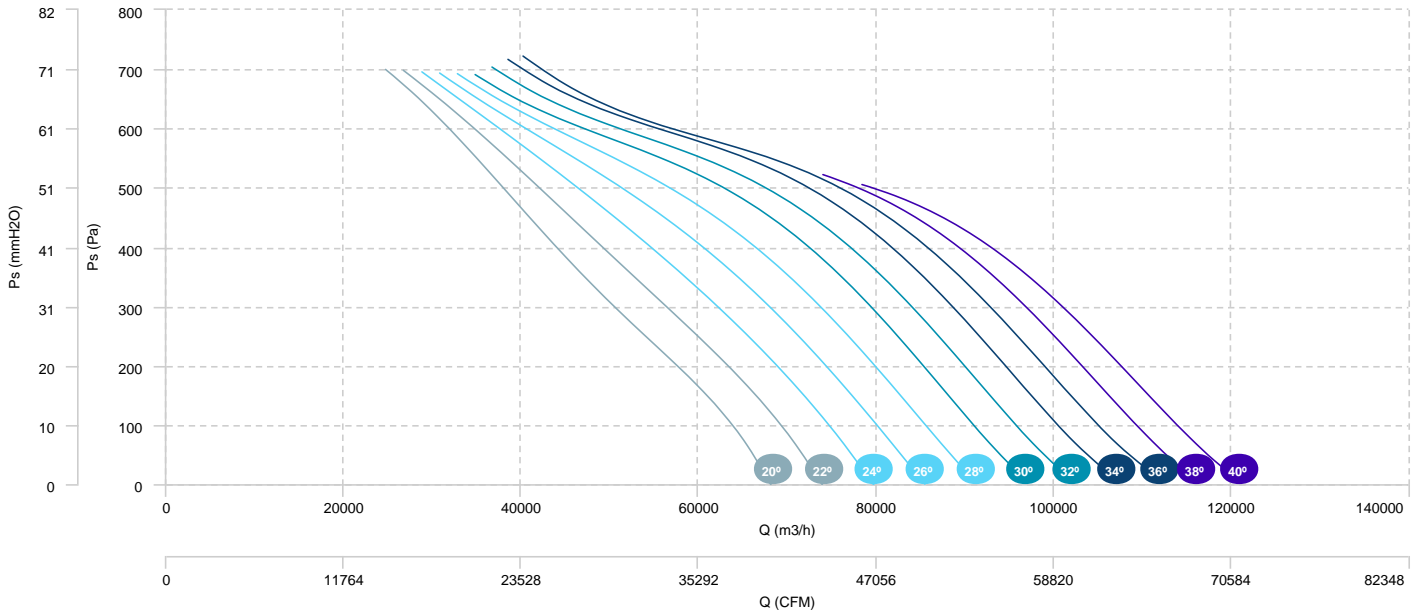

AIR FLOW - ABSORBED POWER

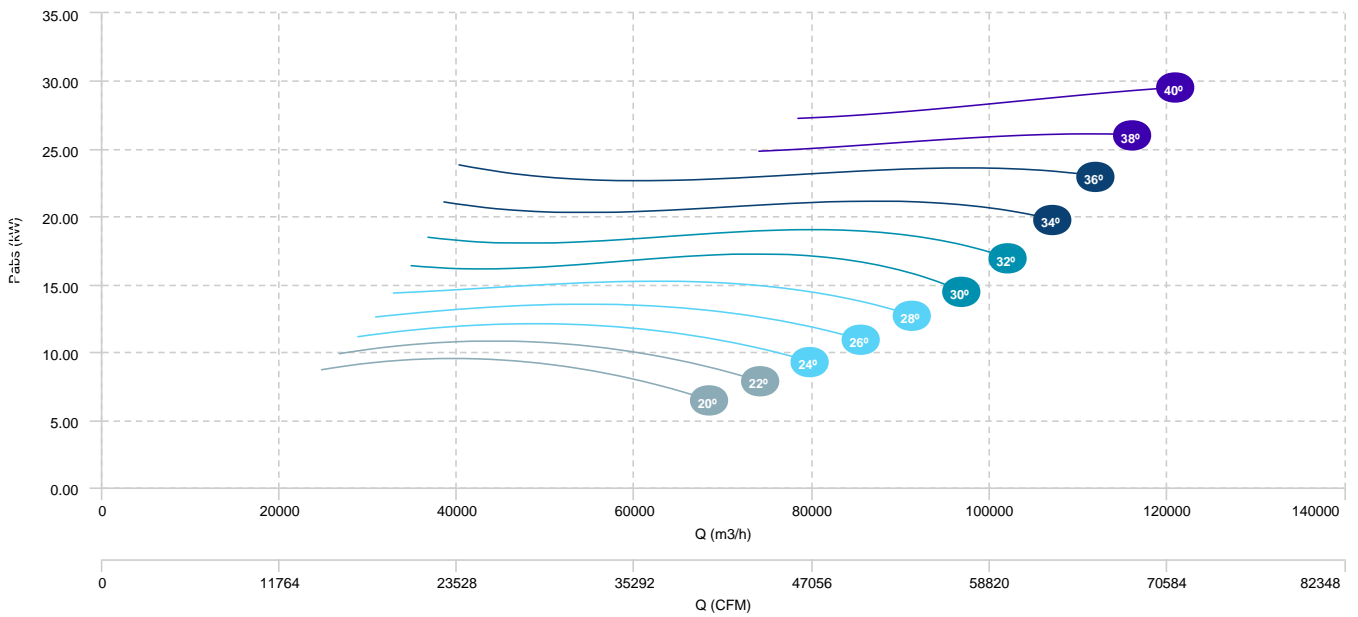

HBFX 125 T4 18,5kW (A3:8)	HBFX 125 T4 22kW (A3:8)	HBFX 125 T4 30kW (A3:8)
HBFX 125 T4 37kW (A3:8)	HBFX 125 T4 45kW (A3:8)	

AIR FLOW - PRESSURE

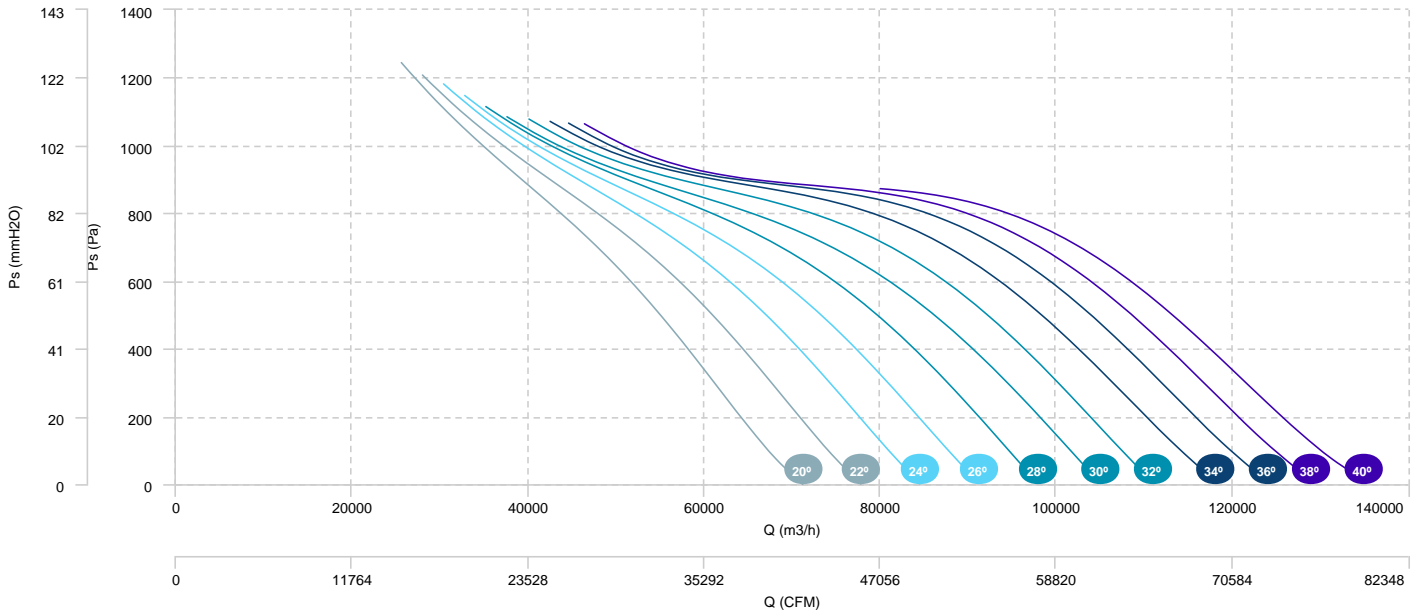

AIR FLOW - ABSORBED POWER

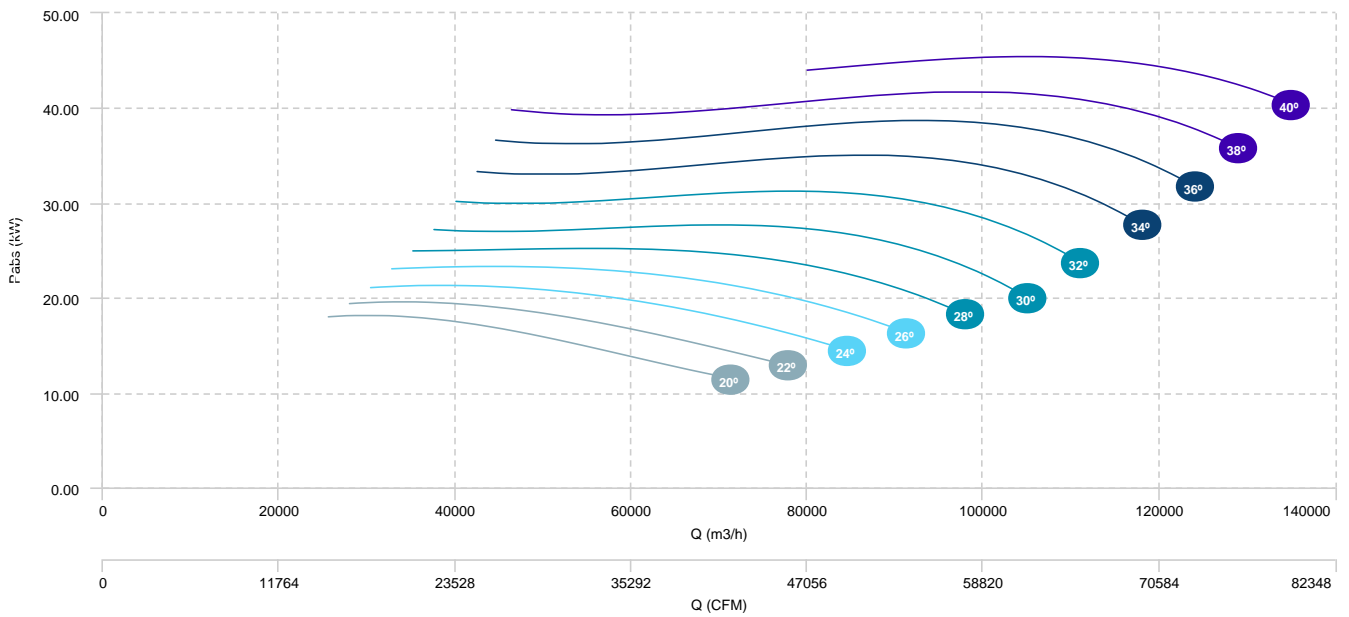

HBFX 125 T6 3kW (A3:4)	HBFX 125 T6 4kW (A3:4)	HBFX 125 T6 5,5kW (A3:4)
HBFX 125 T6 7,5kW (A3:4)		

AIR FLOW - PRESSURE

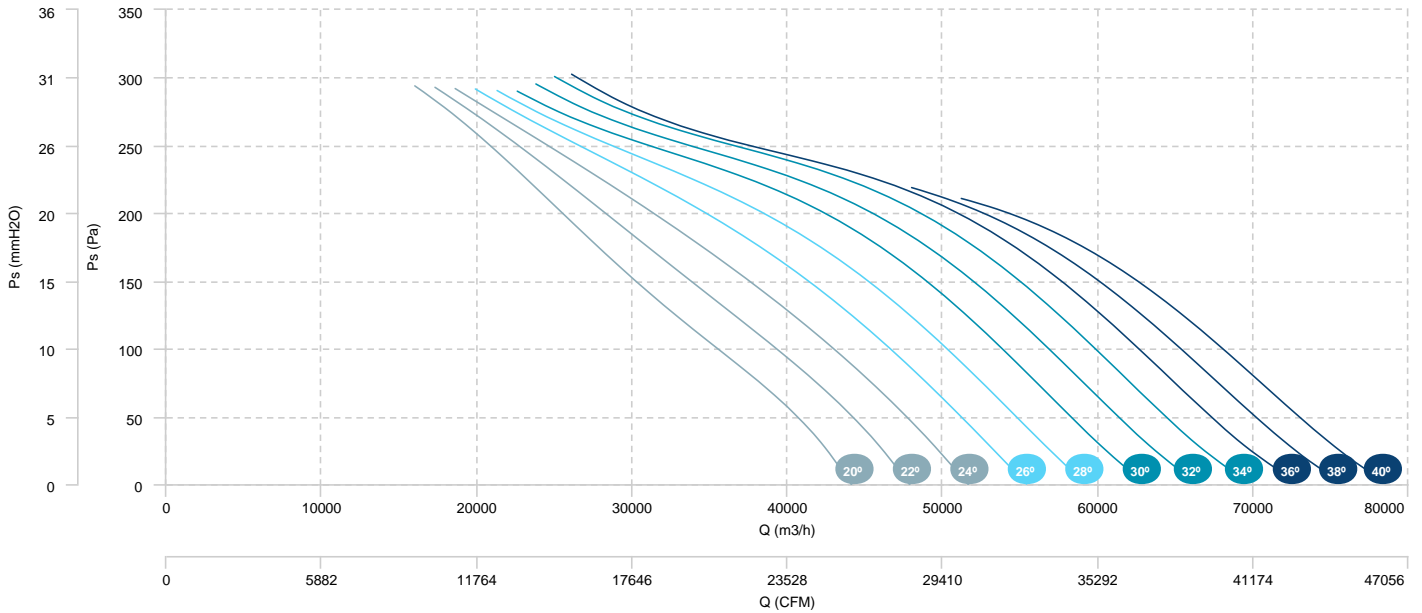

AIR FLOW - ABSORBED POWER

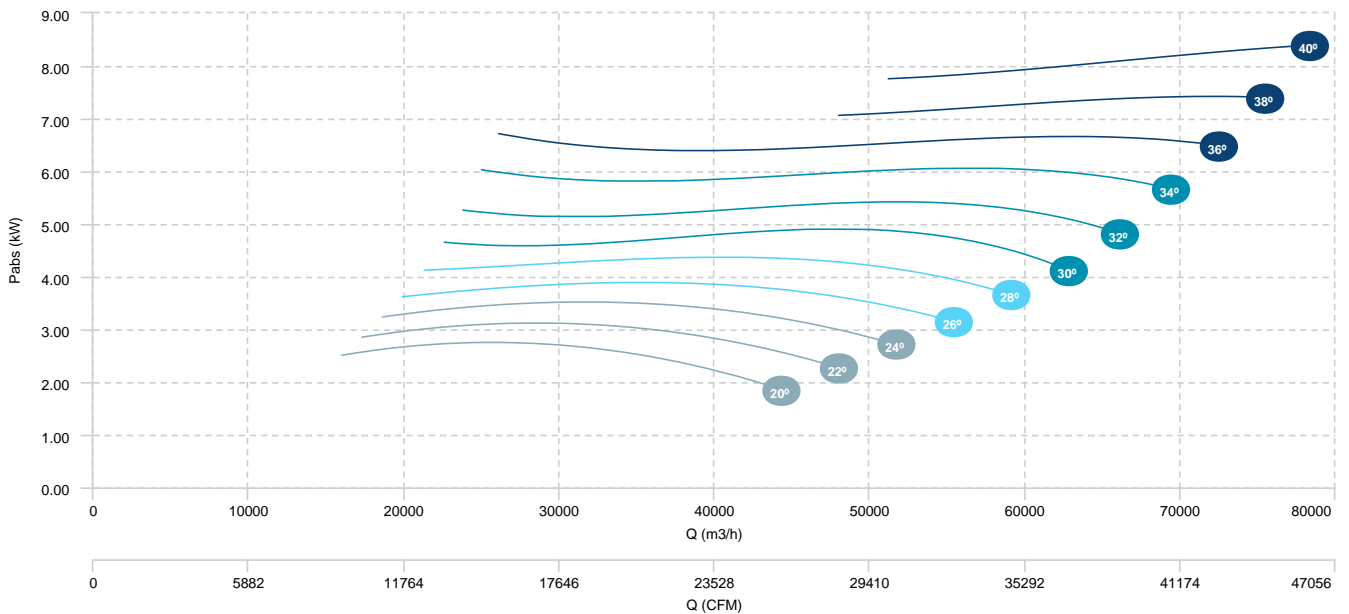

- HBFX 125 T6 5,5kW (A3:8)
- HBFX 125 T6 7,5kW (A3:8)
- HBFX 125 T6 11kW (A3:8)
- HBFX 125 T6 15kW (A3:8)

**AIR FLOW - PRESSURE**

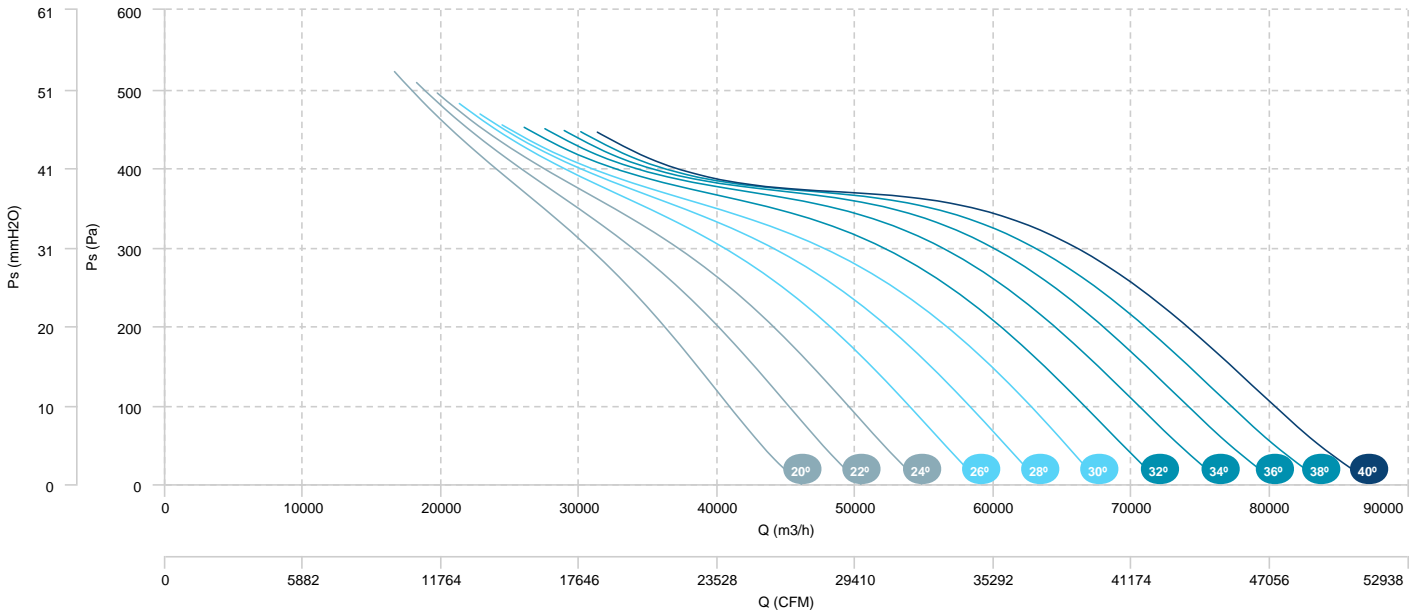

**AIR FLOW - ABSORBED POWER**

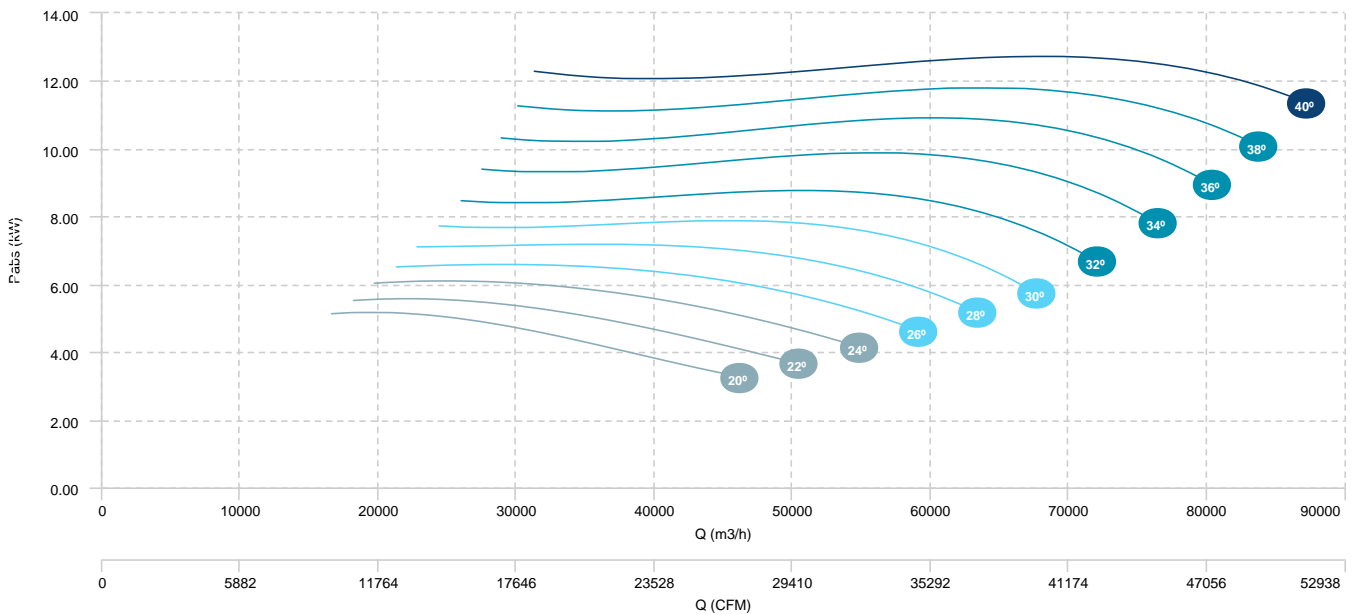

HBFX 125 T4/T8 11/3kW (A3:4)	HBFX 125 T4/T8 14/3,5kW (A3:4)	HBFX 125 T4/T8 17/4,3kW (A3:4)
HBFX 125 T4/T8 20/5kW (A3:4)	HBFX 125 T4/T8 28/6,5kW (A3:4)	

**AIR FLOW - PRESSURE (4 poles)**

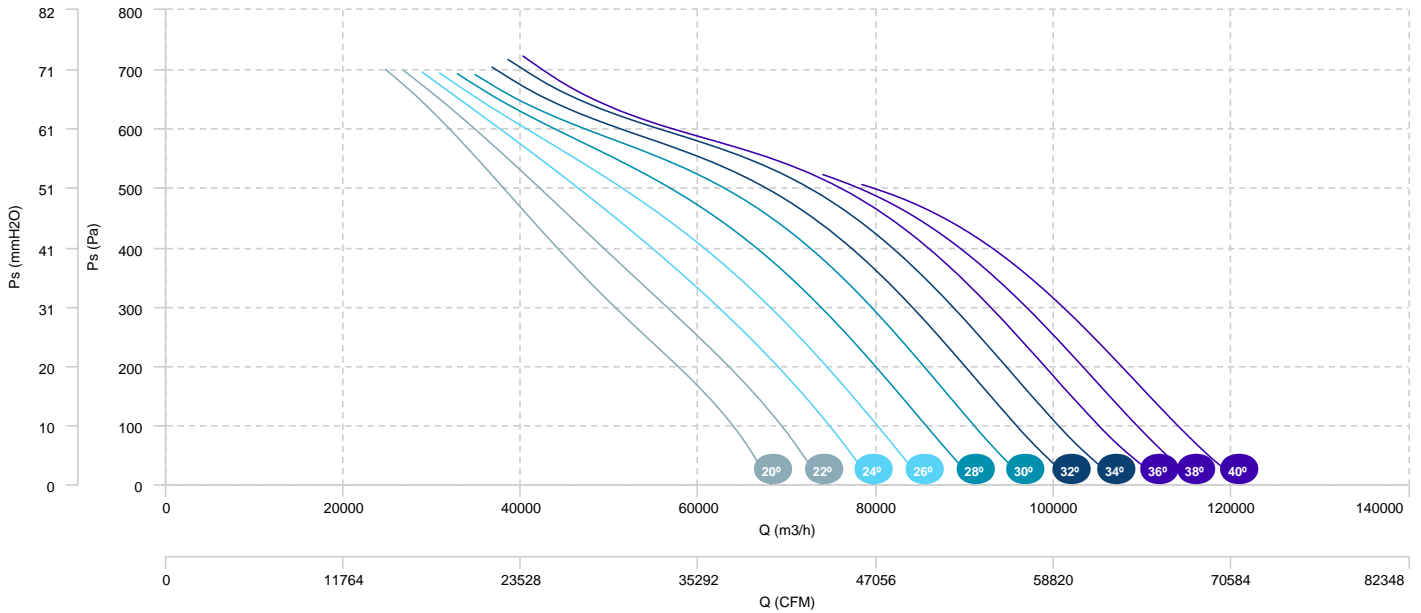

**AIR FLOW - ABSORBED POWER (4 poles)**

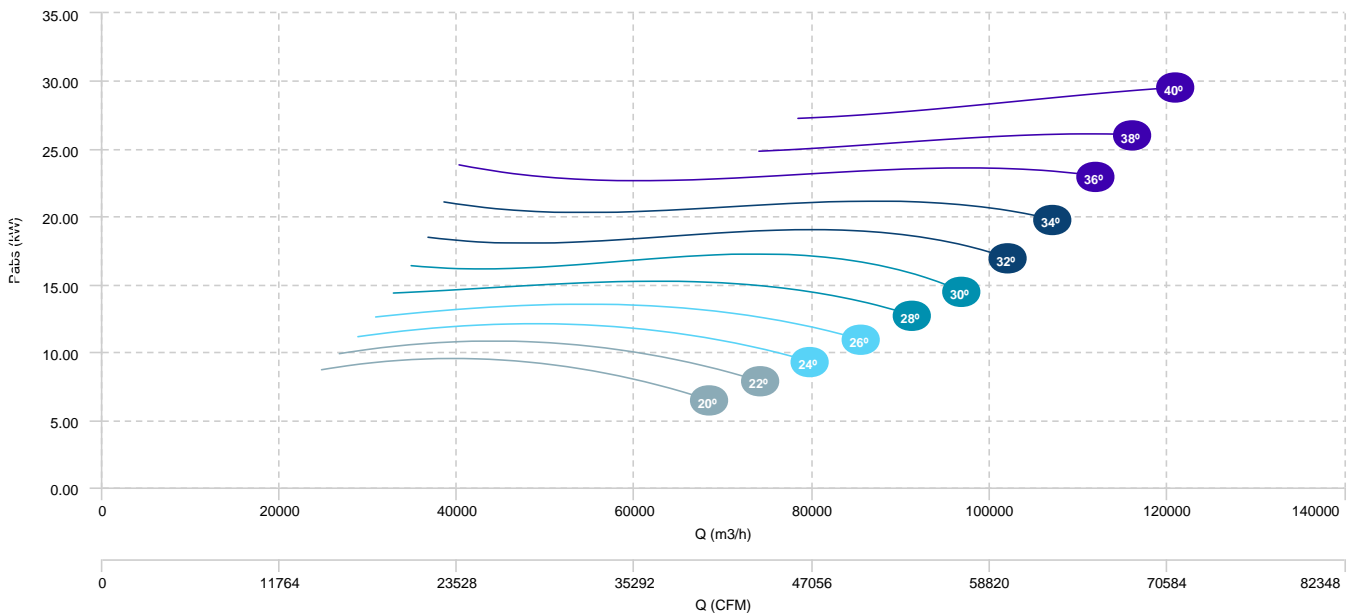



HBFX 125 T4/T8 11/3kW (A3:4)	HBFX 125 T4/T8 14/3,5kW (A3:4)	HBFX 125 T4/T8 17/4,3kW (A3:4)
HBFX 125 T4/T8 20/5kW (A3:4)	HBFX 125 T4/T8 28/6,5kW (A3:4)	

**AIR FLOW - PRESSURE (8 poles)**

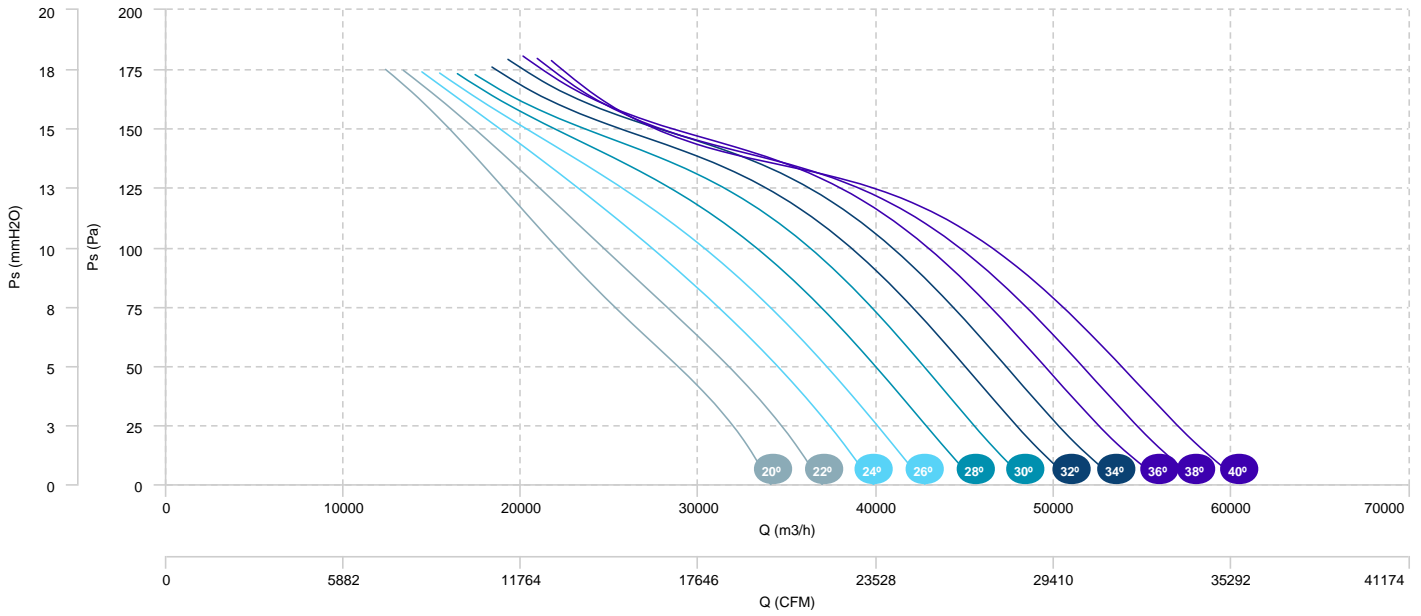

HBFX 125 T4/T8 20/5kW (A3:8)  
 HBFX 125 T4/T8 44/11kW (A3:8)

HBFX 125 T4/T8 28/6,5kW (A3:8)

HBFX 125 T4/T8 37/9,2kW (A3:8)

**AIR FLOW - PRESSURE (4 poles)**

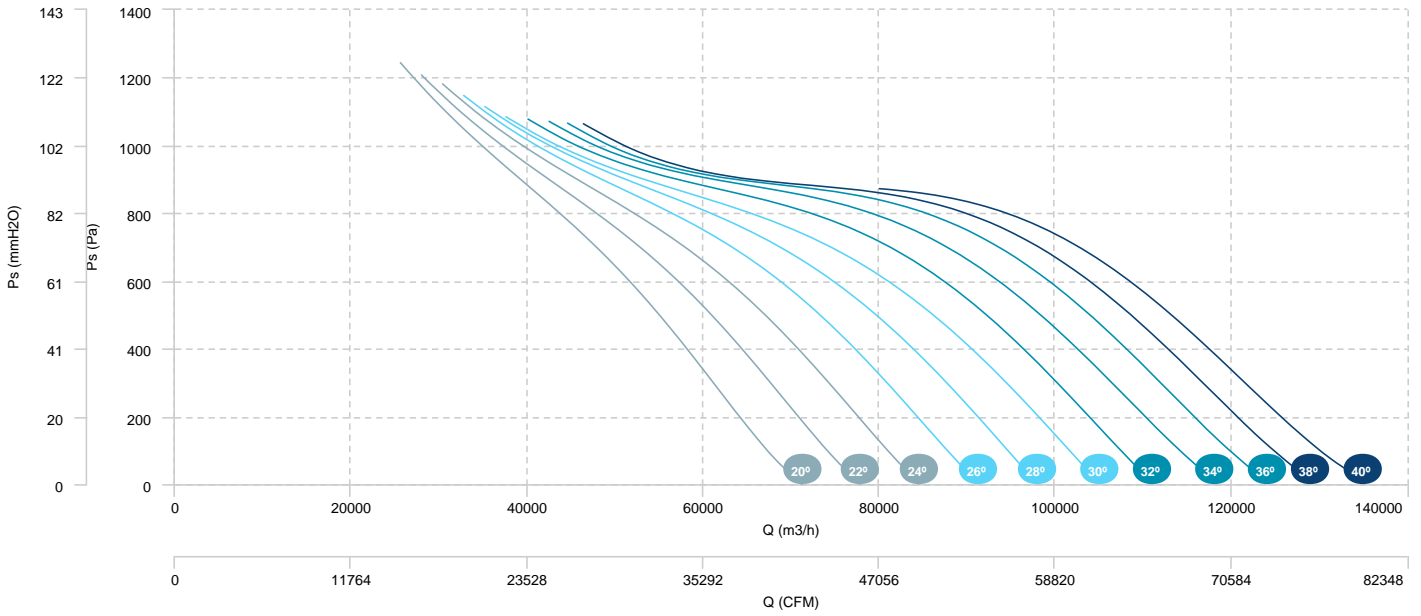

**AIR FLOW - ABSORBED POWER (4 poles)**

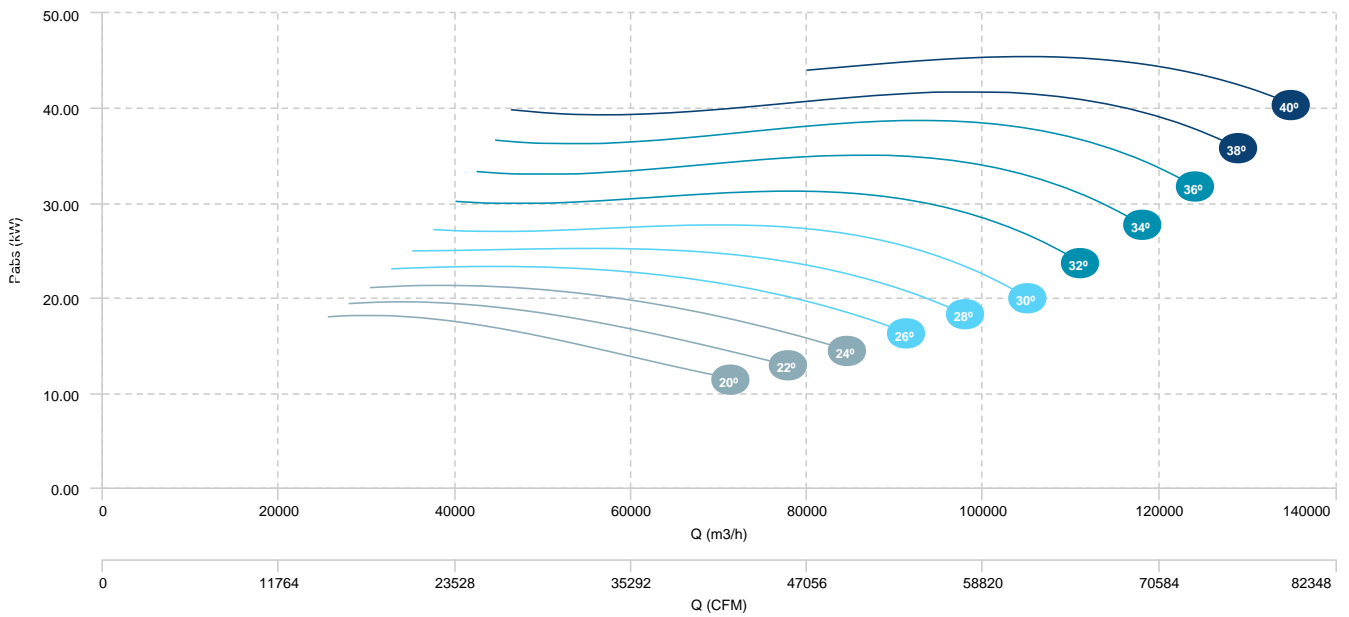

HBFX 125 T4/T8 20/5kW (A3:8)  
 HBFX 125 T4/T8 44/11kW (A3:8)

HBFX 125 T4/T8 28/6,5kW (A3:8)

HBFX 125 T4/T8 37/9,2kW (A3:8)

AIR FLOW - PRESSURE (8 poles)

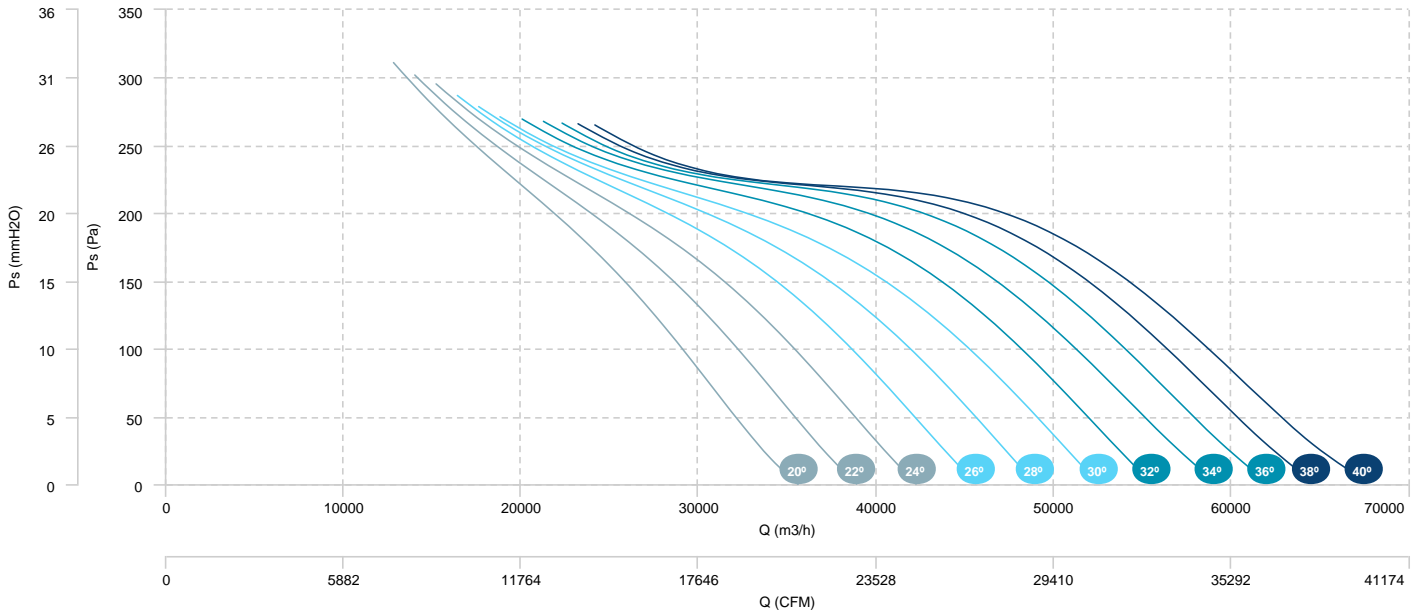

## Sound data

### Sound / 4 poles

		Sound power Lw dB (A)								
Model		63 Hz	125 Hz	250 Hz	500 Hz	1000 Hz	2000 Hz	4000 Hz	8000 Hz	Total
HBFX 45 T4 0,75kW (A5:6) (40°)	Inlet	50	57	62	67	70	70	71	64	76
HBFX 50 T4 0,75kW (A5:6) (40°)	Inlet	53	60	65	69	72	71	72	66	78
HBFX 56 T4 0,75kW (A5:6) (25°)	Inlet	54	62	67	75	79	76	78	70	84
HBFX 56 T4 0,75kW (A5:6) (33°)	Inlet	54	61	66	75	75	76	79	70	83
HBFX 56 T4 0,75kW (A5:6) (30°)	Inlet	56	63	68	77	78	78	80	72	85
HBFX 56 T4 1,1kW (A5:6) (37°)	Inlet	54	61	66	75	74	76	78	69	82
HBFX 56 T4 1,1kW (A5:6) (35°)	Inlet	53	60	65	74	73	75	78	69	82
HBFX 56 T4 1,5kW (A5:6) (40°)	Inlet	56	63	68	76	75	76	79	70	83
HBFX 56 T4 1,5kW (A5:6) (43°)	Inlet	58	65	70	76	76	77	79	70	84
HBFX 63 T4 0,75kW (A5:6) (25°)	Inlet	57	66	71	80	80	79	80	75	86
HBFX 63 T4 1,1kW (A5:6) (30°)	Inlet	60	68	74	80	80	79	82	77	87
HBFX 63 T4 1,5kW (A5:6) (35°)	Inlet	59	67	72	75	76	76	79	73	83
HBFX 63 T4 1,5kW (A5:6) (33°)	Inlet	59	68	73	77	78	77	80	75	85
HBFX 63 T4 2,2kW (A5:6) (40°)	Inlet	60	67	72	77	78	78	80	73	85
HBFX 63 T4 2,2kW (A5:6) (37°)	Inlet	59	67	72	76	77	77	79	73	84
HBFX 71 T4 0,75kW (A5:6) (20°)	Inlet	55	66	71	86	85	82	84	76	91
HBFX 71 T4 1,1kW (A5:6) (25°)	Inlet	59	67	72	84	84	82	84	75	90
HBFX 71 T4 1,5kW (A5:6) (30°)	Inlet	61	68	73	82	82	83	84	73	89
HBFX 71 T4 2,2kW (A5:6) (35°)	Inlet	62	69	74	76	80	82	83	72	87
HBFX 71 T4 2,2kW (A5:6) (33°)	Inlet	62	69	74	79	81	83	84	73	88
HBFX 71 T4 3kW (A5:6) (40°)	Inlet	67	73	79	81	84	85	86	76	91
HBFX 71 T4 3kW (A5:6) (37°)	Inlet	65	71	77	79	82	84	85	74	89
HBFX 80 T4 3kW (A5:6) (35°)	Inlet	62	69	74	79	82	82	86	76	89
HBFX 80 T4 3kW (A5:6) (33°)	Inlet	63	70	75	81	85	84	88	80	91
HBFX 80 T4 3kW (A5:6) (30°)	Inlet	64	71	76	83	87	86	90	83	94
HBFX 80 T4 4kW (A5:6) (37°)	Inlet	64	71	76	80	83	83	86	76	90
HBFX 80 T4 4kW (A5:6) (40°)	Inlet	66	73	78	82	84	84	86	76	91
HBFX 90 T4 3kW (A3:4) (22°)	Inlet	61	69	74	83	87	87	86	77	92
HBFX 90 T4 3kW (A3:4) (20°)	Inlet	57	68	73	84	88	88	86	78	93
HBFX 90 T4 4kW (A3:4) (26°)	Inlet	64	71	76	83	85	85	84	76	91
HBFX 90 T4 4kW (A3:4) (24°)	Inlet	63	70	75	83	86	86	85	77	91
HBFX 90 T4 5,5kW (A3:4) (30°)	Inlet	66	73	78	83	83	83	83	75	89
HBFX 90 T4 5,5kW (A3:4) (28°)	Inlet	65	72	77	83	84	84	84	76	90
HBFX 90 T4 5,5kW (A3:4) (32°)	Inlet	66	73	78	82	83	83	83	75	89
HBFX 90 T4 5,5kW (A3:8) (22°)	Inlet	69	80	88	90	92	87	88	78	97
HBFX 90 T4 5,5kW (A3:8) (20°)	Inlet	69	81	90	91	93	87	88	78	98

**Sound power Lw dB (A)**

Model		63 Hz	125 Hz	250 Hz	500 Hz	1000 Hz	2000 Hz	4000 Hz	8000 Hz	Total
HBFX 90 T4 5,5kW (A3:8) (24°)	Inlet	69	79	86	89	91	88	88	78	96
HBFX 90 T4 7,5kW (A3:4) (34°)	Inlet	65	72	77	81	83	84	82	74	89
HBFX 90 T4 7,5kW (A3:4) (38°)	Inlet	67	74	79	82	85	84	83	76	91
HBFX 90 T4 7,5kW (A3:4) (36°)	Inlet	66	73	78	81	84	84	82	74	90
HBFX 90 T4 7,5kW (A3:8) (28°)	Inlet	70	76	82	87	89	88	87	79	94
HBFX 90 T4 7,5kW (A3:8) (26°)	Inlet	70	78	84	88	90	88	88	79	95
HBFX 90 T4 11kW (A3:4) (40°)	Inlet	68	75	80	83	87	85	84	77	91
HBFX 90 T4 11kW (A3:8) (36°)	Inlet	67	74	79	83	87	87	85	77	92
HBFX 90 T4 11kW (A3:8) (34°)	Inlet	67	74	79	84	87	87	85	77	92
HBFX 90 T4 11kW (A3:8) (32°)	Inlet	67	74	79	85	87	87	86	78	93
HBFX 90 T4 11kW (A3:8) (30°)	Inlet	68	75	80	86	88	88	87	79	94
HBFX 90 T4 15kW (A3:8) (40°)	Inlet	71	78	83	84	88	87	84	78	93
HBFX 90 T4 15kW (A3:8) (38°)	Inlet	69	76	81	84	87	87	84	77	92
HBFX 100 T4 5,5kW (A3:4) (26°)	Inlet	67	75	81	87	90	91	93	88	97
HBFX 100 T4 5,5kW (A3:4) (24°)	Inlet	67	76	81	87	91	92	93	89	98
HBFX 100 T4 5,5kW (A3:4) (22°)	Inlet	66	76	82	88	91	92	93	90	98
HBFX 100 T4 5,5kW (A3:4) (20°)	Inlet	66	76	81	88	91	92	93	90	98
HBFX 100 T4 7,5kW (A3:4) (30°)	Inlet	68	74	81	86	90	91	93	86	97
HBFX 100 T4 7,5kW (A3:4) (28°)	Inlet	67	75	81	86	90	91	93	87	97
HBFX 100 T4 7,5kW (A3:8) (20°)	Inlet	72	81	92	102	100	99	100	95	107
HBFX 100 T4 11kW (A3:4) (38°)	Inlet	68	74	81	86	89	90	92	85	96
HBFX 100 T4 11kW (A3:4) (36°)	Inlet	69	73	81	86	88	90	91	85	96
HBFX 100 T4 11kW (A3:4) (34°)	Inlet	69	73	81	85	88	90	91	85	96
HBFX 100 T4 11kW (A3:4) (32°)	Inlet	68	74	81	86	89	90	92	86	96
HBFX 100 T4 11kW (A3:8) (28°)	Inlet	72	79	87	93	96	95	96	91	102
HBFX 100 T4 11kW (A3:8) (24°)	Inlet	72	79	89	97	97	97	98	93	104
HBFX 100 T4 11kW (A3:8) (22°)	Inlet	72	80	91	100	99	98	99	94	106
HBFX 100 T4 11kW (A3:8) (26°)	Inlet	72	79	88	95	96	96	97	92	103
HBFX 100 T4 15kW (A3:4) (40°)	Inlet	68	75	81	87	90	91	92	86	97
HBFX 100 T4 15kW (A3:8) (34°)	Inlet	71	78	83	88	92	93	94	88	99
HBFX 100 T4 15kW (A3:8) (32°)	Inlet	71	79	84	90	93	94	95	89	100
HBFX 100 T4 15kW (A3:8) (30°)	Inlet	72	79	86	91	95	95	96	90	101
HBFX 100 T4 18,5kW (A3:8) (38°)	Inlet	71	78	83	88	92	94	94	88	99
HBFX 100 T4 18,5kW (A3:8) (36°)	Inlet	70	77	82	87	91	93	94	87	99
HBFX 100 T4 22kW (A3:8) (40°)	Inlet	71	79	84	89	92	94	95	89	100
HBFX 112 T4 5,5kW (A3:4) (20°)	Inlet	66	78	83	90	94	94	96	92	101
HBFX 112 T4 7,5kW (A3:4) (22°)	Inlet	68	79	84	90	94	95	96	92	102
HBFX 112 T4 7,5kW (A3:4) (24°)	Inlet	69	78	83	90	93	94	96	91	101
HBFX 112 T4 11kW (A3:4) (32°)	Inlet	70	77	82	87	91	92	94	87	98

Sound power Lw dB (A)										
Model		63 Hz	125 Hz	250 Hz	500 Hz	1000 Hz	2000 Hz	4000 Hz	8000 Hz	Total
HBFX 112 T4 11kW (A3:4) (30°)	Inlet	71	78	83	88	92	93	94	88	99
HBFX 112 T4 11kW (A3:4) (28°)	Inlet	71	78	83	89	92	93	95	89	99
HBFX 112 T4 11kW (A3:4) (26°)	Inlet	70	78	83	89	93	94	95	90	100
HBFX 112 T4 11kW (A3:8) (22°)	Inlet	73	81	91	99	100	102	102	96	107
HBFX 112 T4 11kW (A3:8) (20°)	Inlet	73	82	92	101	101	103	103	97	109
HBFX 112 T4 15kW (A3:4) (38°)	Inlet	71	77	83	88	91	92	93	87	98
HBFX 112 T4 15kW (A3:4) (34°)	Inlet	70	76	82	87	90	92	93	86	98
HBFX 112 T4 15kW (A3:4) (36°)	Inlet	71	76	83	87	90	92	93	86	98
HBFX 112 T4 15kW (A3:8) (26°)	Inlet	74	81	89	96	98	100	100	94	106
HBFX 112 T4 15kW (A3:8) (24°)	Inlet	73	81	90	97	99	101	101	95	106
HBFX 112 T4 15kW (A3:8) (28°)	Inlet	74	81	88	94	98	99	99	94	105
HBFX 112 T4 18,5kW (A3:4) (40°)	Inlet	72	79	84	89	91	93	94	87	99
HBFX 112 T4 18,5kW (A3:8) (32°)	Inlet	74	81	86	91	96	97	97	91	103
HBFX 112 T4 18,5kW (A3:8) (30°)	Inlet	74	80	87	93	97	99	99	93	104
HBFX 112 T4 22kW (A3:8) (34°)	Inlet	73	80	85	90	94	96	96	89	101
HBFX 112 T4 22kW (A3:8) (36°)	Inlet	73	80	85	90	93	95	95	89	101
HBFX 112 T4 30kW (A3:8) (40°)	Inlet	74	81	86	90	94	96	95	90	101
HBFX 112 T4 30kW (A3:8) (38°)	Inlet	73	80	85	90	94	96	95	89	101
HBFX 125 T4 11kW (A3:4) (22°)	Inlet	75	86	91	98	102	103	105	101	109
HBFX 125 T4 11kW (A3:4) (20°)	Inlet	72	85	90	98	102	102	104	101	109
HBFX 125 T4 15kW (A3:4) (28°)	Inlet	75	82	87	93	96	98	99	93	104
HBFX 125 T4 15kW (A3:4) (26°)	Inlet	76	84	89	94	98	99	101	95	106
HBFX 125 T4 15kW (A3:4) (24°)	Inlet	75	85	90	96	100	101	103	98	107
HBFX 125 T4 18,5kW (A3:4) (32°)	Inlet	74	81	86	90	94	96	96	90	102
HBFX 125 T4 18,5kW (A3:4) (30°)	Inlet	74	81	86	91	95	96	97	91	102
HBFX 125 T4 18,5kW (A3:8) (22°)	Inlet	79	86	93	102	107	110	109	104	114
HBFX 125 T4 18,5kW (A3:8) (20°)	Inlet	78	86	93	103	108	111	110	105	115
HBFX 125 T4 22kW (A3:4) (36°)	Inlet	74	81	86	90	93	95	96	88	101
HBFX 125 T4 22kW (A3:4) (34°)	Inlet	73	80	85	90	93	95	96	88	101
HBFX 125 T4 22kW (A3:8) (24°)	Inlet	78	85	92	100	106	108	108	102	113
HBFX 125 T4 22kW (A3:8) (26°)	Inlet	78	85	91	98	104	106	106	100	111
HBFX 125 T4 30kW (A3:4) (40°)	Inlet	75	82	87	91	93	96	96	89	102
HBFX 125 T4 30kW (A3:4) (38°)	Inlet	74	81	86	91	93	95	96	89	101
HBFX 125 T4 30kW (A3:8) (30°)	Inlet	77	83	90	96	101	103	104	97	108
HBFX 125 T4 30kW (A3:8) (28°)	Inlet	78	84	91	97	102	105	105	98	110
HBFX 125 T4 30kW (A3:8) (32°)	Inlet	77	83	89	95	99	102	102	94	107
HBFX 125 T4 37kW (A3:8) (36°)	Inlet	77	83	89	93	96	98	98	91	104
HBFX 125 T4 37kW (A3:8) (34°)	Inlet	77	83	89	94	97	99	100	92	105
HBFX 125 T4 45kW (A3:8) (40°)	Inlet	76	83	88	93	96	98	97	90	103

**Sound power Lw dB (A)**

Model		63 Hz	125 Hz	250 Hz	500 Hz	1000 Hz	2000 Hz	4000 Hz	8000 Hz	Total
HBFX 125 T4 45kW (A3:8) (38°)	Inlet	76	83	88	93	96	98	97	91	104

**Sound / 6 poles**
**Sound power Lw dB (A)**

Model		63 Hz	125 Hz	250 Hz	500 Hz	1000 Hz	2000 Hz	4000 Hz	8000 Hz	Total
HBFX 50 T6 0,75kW (A5:6) (40°)	Inlet	44	51	56	60	63	62	64	57	69
HBFX 56 T6 0,75kW (A5:6) (40°)	Inlet	47	54	59	67	66	67	70	61	74
HBFX 63 T6 0,75kW (A5:6) (40°)	Inlet	51	58	63	68	69	69	71	64	76
HBFX 71 T6 0,75kW (A5:6) (40°)	Inlet	59	65	71	73	76	77	78	68	83
HBFX 71 T6 0,75kW (A5:6) (37°)	Inlet	56	63	68	70	73	75	76	65	81
HBFX 71 T6 0,75kW (A5:6) (35°)	Inlet	54	61	66	67	71	73	74	63	79
HBFX 80 T6 0,75kW (A5:6) (30°)	Inlet	55	62	67	74	78	77	81	74	85
HBFX 80 T6 1,1kW (A5:6) (33°)	Inlet	54	61	66	72	76	75	79	71	83
HBFX 80 T6 1,1kW (A5:6) (35°)	Inlet	53	60	65	70	73	74	77	67	81
HBFX 80 T6 1,5kW (A5:6) (37°)	Inlet	55	62	67	71	74	75	77	68	81
HBFX 80 T6 1,5kW (A5:6) (40°)	Inlet	57	64	69	73	75	76	77	68	82
HBFX 80 T6 2,2kW (A5:6) (43°)	Inlet	58	65	70	74	76	76	77	68	82
HBFX 90 T6 1,5kW (A3:4) (20°)	Inlet	47	58	63	74	78	78	77	69	83
HBFX 90 T6 1,5kW (A3:4) (26°)	Inlet	55	62	67	74	75	75	75	67	81
HBFX 90 T6 1,5kW (A3:4) (22°)	Inlet	51	60	65	74	77	77	76	68	83
HBFX 90 T6 1,5kW (A3:4) (30°)	Inlet	57	64	69	73	73	73	74	66	80
HBFX 90 T6 1,5kW (A3:4) (24°)	Inlet	54	61	66	74	76	76	76	67	82
HBFX 90 T6 1,5kW (A3:4) (32°)	Inlet	57	64	69	73	74	74	73	65	80
HBFX 90 T6 1,5kW (A3:4) (28°)	Inlet	56	63	68	73	74	74	74	66	81
HBFX 90 T6 1,5kW (A3:8) (24°)	Inlet	60	69	77	80	82	78	78	69	86
HBFX 90 T6 1,5kW (A3:8) (22°)	Inlet	60	71	79	81	83	78	78	69	87
HBFX 90 T6 1,5kW (A3:8) (20°)	Inlet	60	72	81	82	84	78	79	69	88
HBFX 90 T6 2,2kW (A3:4) (36°)	Inlet	56	63	68	72	75	75	73	65	80
HBFX 90 T6 2,2kW (A3:4) (40°)	Inlet	59	66	71	73	77	75	74	67	82
HBFX 90 T6 2,2kW (A3:4) (38°)	Inlet	58	65	70	73	76	75	74	66	81
HBFX 90 T6 2,2kW (A3:4) (34°)	Inlet	56	63	68	72	74	74	73	65	80
HBFX 90 T6 2,2kW (A3:8) (30°)	Inlet	59	66	71	77	79	79	78	70	84
HBFX 90 T6 2,2kW (A3:8) (28°)	Inlet	60	67	73	78	80	78	78	70	85
HBFX 90 T6 2,2kW (A3:8) (26°)	Inlet	60	68	75	79	81	78	78	69	86
HBFX 90 T6 3kW (A3:8) (36°)	Inlet	58	65	70	74	77	77	75	68	83
HBFX 90 T6 3kW (A3:8) (34°)	Inlet	57	64	69	74	77	78	76	68	83
HBFX 90 T6 3kW (A3:8) (32°)	Inlet	58	65	70	76	78	78	77	69	84
HBFX 90 T6 4kW (A3:8) (40°)	Inlet	61	68	73	75	79	78	75	68	84

Sound power Lw dB (A)										
Model		63 Hz	125 Hz	250 Hz	500 Hz	1000 Hz	2000 Hz	4000 Hz	8000 Hz	Total
HBFX 90 T6 4kW (A3:8) (38°)	Inlet	59	66	71	74	78	78	75	68	83
HBFX 100 T6 1,5kW (A3:4) (26°)	Inlet	57	66	71	77	81	82	83	78	88
HBFX 100 T6 1,5kW (A3:4) (20°)	Inlet	56	67	72	78	82	83	84	81	89
HBFX 100 T6 1,5kW (A3:4) (24°)	Inlet	57	66	72	78	82	82	84	79	89
HBFX 100 T6 1,5kW (A3:4) (22°)	Inlet	57	67	72	78	82	83	84	80	89
HBFX 100 T6 2,2kW (A3:4) (26°)	Inlet	57	66	71	77	81	82	83	78	88
HBFX 100 T6 2,2kW (A3:4) (20°)	Inlet	56	67	72	78	82	83	84	81	89
HBFX 100 T6 2,2kW (A3:4) (32°)	Inlet	59	64	71	76	79	81	83	76	87
HBFX 100 T6 2,2kW (A3:4) (30°)	Inlet	58	65	71	77	80	81	83	77	87
HBFX 100 T6 2,2kW (A3:4) (28°)	Inlet	58	65	71	77	81	81	83	78	88
HBFX 100 T6 2,2kW (A3:4) (24°)	Inlet	57	66	72	78	82	82	84	79	89
HBFX 100 T6 2,2kW (A3:4) (22°)	Inlet	57	67	72	78	82	83	84	80	89
HBFX 100 T6 2,2kW (A3:8) (22°)	Inlet	63	71	82	90	89	88	89	85	96
HBFX 100 T6 2,2kW (A3:8) (20°)	Inlet	63	71	83	92	91	89	90	86	97
HBFX 100 T6 3kW (A3:4) (38°)	Inlet	59	65	72	77	80	81	82	76	87
HBFX 100 T6 3kW (A3:4) (34°)	Inlet	59	63	71	76	79	80	82	76	86
HBFX 100 T6 3kW (A3:4) (36°)	Inlet	59	64	71	76	79	80	82	76	86
HBFX 100 T6 3kW (A3:8) (24°)	Inlet	62	70	80	88	88	87	88	83	94
HBFX 100 T6 3kW (A3:8) (28°)	Inlet	62	70	78	84	86	86	87	81	92
HBFX 100 T6 3kW (A3:8) (26°)	Inlet	62	70	79	86	87	87	87	82	93
HBFX 100 T6 4kW (A3:4) (40°)	Inlet	59	66	72	77	81	81	83	76	87
HBFX 100 T6 4kW (A3:8) (34°)	Inlet	61	68	73	78	82	84	85	78	89
HBFX 100 T6 4kW (A3:8) (32°)	Inlet	62	69	75	80	84	85	85	79	90
HBFX 100 T6 4kW (A3:8) (30°)	Inlet	62	69	77	82	85	86	86	80	92
HBFX 100 T6 5,5kW (A3:8) (36°)	Inlet	61	68	73	78	82	84	84	78	89
HBFX 100 T6 5,5kW (A3:8) (40°)	Inlet	62	69	74	79	83	85	85	79	90
HBFX 100 T6 5,5kW (A3:8) (38°)	Inlet	61	68	73	79	82	84	85	79	90
HBFX 112 T6 2,2kW (A3:4) (26°)	Inlet	60	69	74	80	83	84	86	80	90
HBFX 112 T6 2,2kW (A3:4) (24°)	Inlet	59	69	74	80	84	85	86	81	91
HBFX 112 T6 2,2kW (A3:4) (22°)	Inlet	58	69	74	81	85	85	87	82	92
HBFX 112 T6 2,2kW (A3:4) (20°)	Inlet	56	68	73	80	84	85	87	82	91
HBFX 112 T6 3kW (A3:4) (28°)	Inlet	61	68	73	79	83	84	85	79	90
HBFX 112 T6 3kW (A3:4) (32°)	Inlet	61	67	73	78	81	83	84	78	89
HBFX 112 T6 3kW (A3:4) (30°)	Inlet	61	68	73	79	82	83	85	78	89
HBFX 112 T6 3kW (A3:8) (22°)	Inlet	64	72	81	89	90	92	92	87	98
HBFX 112 T6 3kW (A3:8) (20°)	Inlet	64	72	82	91	91	93	93	88	99
HBFX 112 T6 4kW (A3:4) (38°)	Inlet	62	68	74	78	81	83	84	77	89
HBFX 112 T6 4kW (A3:4) (36°)	Inlet	61	67	73	78	81	82	84	77	88
HBFX 112 T6 4kW (A3:4) (34°)	Inlet	61	66	73	78	81	82	84	77	88



Sound power Lw dB (A)										
Model		63 Hz	125 Hz	250 Hz	500 Hz	1000 Hz	2000 Hz	4000 Hz	8000 Hz	Total
HBFX 112 T6 4kW (A3:8) (28°)	Inlet	64	71	79	85	89	90	90	84	95
HBFX 112 T6 4kW (A3:8) (26°)	Inlet	64	71	79	86	89	90	90	85	96
HBFX 112 T6 4kW (A3:8) (24°)	Inlet	64	71	80	88	90	91	91	86	96
HBFX 112 T6 5,5kW (A3:4) (40°)	Inlet	63	69	75	79	82	84	84	78	89
HBFX 112 T6 5,5kW (A3:8) (30°)	Inlet	65	71	78	83	88	89	89	84	94
HBFX 112 T6 5,5kW (A3:8) (34°)	Inlet	64	71	76	81	84	86	87	80	92
HBFX 112 T6 5,5kW (A3:8) (32°)	Inlet	64	71	77	82	86	88	88	82	93
HBFX 112 T6 7,5kW (A3:8) (38°)	Inlet	64	71	76	81	84	86	86	80	91
HBFX 112 T6 7,5kW (A3:8) (36°)	Inlet	63	70	75	80	84	86	86	79	91
HBFX 112 T6 7,5kW (A3:8) (40°)	Inlet	64	71	76	81	85	87	86	80	92
HBFX 125 T6 3kW (A3:4) (24°)	Inlet	66	75	80	87	90	91	93	88	98
HBFX 125 T6 3kW (A3:4) (22°)	Inlet	65	77	82	89	92	93	95	91	99
HBFX 125 T6 3kW (A3:4) (20°)	Inlet	63	76	81	89	92	92	94	91	99
HBFX 125 T6 4kW (A3:4) (26°)	Inlet	66	74	79	85	89	90	91	86	96
HBFX 125 T6 4kW (A3:4) (28°)	Inlet	66	73	78	83	87	88	89	84	94
HBFX 125 T6 5,5kW (A3:4) (34°)	Inlet	64	71	76	81	84	85	86	79	91
HBFX 125 T6 5,5kW (A3:4) (32°)	Inlet	64	71	76	81	84	86	87	80	92
HBFX 125 T6 5,5kW (A3:4) (30°)	Inlet	65	72	77	81	85	87	88	81	92
HBFX 125 T6 5,5kW (A3:8) (24°)	Inlet	69	76	83	90	96	98	98	92	103
HBFX 125 T6 5,5kW (A3:8) (22°)	Inlet	69	77	84	92	97	100	99	94	105
HBFX 125 T6 5,5kW (A3:8) (20°)	Inlet	69	77	84	93	98	101	101	95	106
HBFX 125 T6 7,5kW (A3:4) (40°)	Inlet	65	72	77	82	84	86	87	80	92
HBFX 125 T6 7,5kW (A3:4) (38°)	Inlet	65	72	77	81	84	86	86	79	91
HBFX 125 T6 7,5kW (A3:4) (36°)	Inlet	64	71	76	81	83	85	86	79	91
HBFX 125 T6 7,5kW (A3:8) (30°)	Inlet	68	74	80	86	91	93	94	87	98
HBFX 125 T6 7,5kW (A3:8) (28°)	Inlet	68	74	81	87	93	95	95	89	100
HBFX 125 T6 7,5kW (A3:8) (26°)	Inlet	69	75	82	89	94	97	96	90	102
HBFX 125 T6 11kW (A3:8) (38°)	Inlet	67	74	79	84	87	89	88	81	94
HBFX 125 T6 11kW (A3:8) (36°)	Inlet	67	74	79	84	87	89	89	82	94
HBFX 125 T6 11kW (A3:8) (34°)	Inlet	68	74	80	84	88	90	90	83	95
HBFX 125 T6 11kW (A3:8) (32°)	Inlet	68	74	80	85	90	92	92	85	97
HBFX 125 T6 15kW (A3:8) (40°)	Inlet	67	74	79	83	87	89	87	81	93

### Sound / 4/8 poles

Sound power Lw dB (A)										
Model		63 Hz	125 Hz	250 Hz	500 Hz	1000 Hz	2000 Hz	4000 Hz	8000 Hz	Total
HBFX 45 T4/T8 0,8/0,2kW (A5:6) (1500 RPM - 40°)	Inlet	50	57	62	67	70	70	71	64	76



		Sound power Lw dB (A)								
Model		63 Hz	125 Hz	250 Hz	500 Hz	1000 Hz	2000 Hz	4000 Hz	8000 Hz	Total
HBFX 45 T4/T8 0,8/0,2kW (A5:6) (750 RPM - 40°)	Inlet	35	42	47	52	55	55	56	49	61
HBFX 50 T4/T8 0,8/0,2kW (A5:6) (750 RPM - 40°)	Inlet	38	45	50	54	57	56	57	51	63
HBFX 50 T4/T8 0,8/0,2kW (A5:6) (1500 RPM - 40°)	Inlet	53	60	65	69	72	71	72	66	78
HBFX 56 T4/T8 0,8/0,2kW (A5:6) (750 RPM - 33°)	Inlet	39	46	51	60	60	61	64	55	68
HBFX 56 T4/T8 0,8/0,2kW (A5:6) (750 RPM - 25°)	Inlet	39	47	52	60	64	61	63	55	69
HBFX 56 T4/T8 0,8/0,2kW (A5:6) (750 RPM - 30°)	Inlet	41	48	53	62	63	62	65	57	69
HBFX 56 T4/T8 0,8/0,2kW (A5:6) (1500 RPM - 25°)	Inlet	54	62	67	75	79	76	78	70	84
HBFX 56 T4/T8 0,8/0,2kW (A5:6) (1500 RPM - 33°)	Inlet	54	61	66	75	75	76	79	70	83
HBFX 56 T4/T8 0,8/0,2kW (A5:6) (1500 RPM - 30°)	Inlet	56	63	68	77	78	78	80	72	85
HBFX 56 T4/T8 1,2/0,3kW (A5:6) (750 RPM - 37°)	Inlet	39	46	51	59	59	60	63	54	67
HBFX 56 T4/T8 1,2/0,3kW (A5:6) (750 RPM - 35°)	Inlet	38	45	50	58	58	60	62	54	66
HBFX 56 T4/T8 1,2/0,3kW (A5:6) (1500 RPM - 37°)	Inlet	54	61	66	75	74	76	78	69	82
HBFX 56 T4/T8 1,2/0,3kW (A5:6) (1500 RPM - 35°)	Inlet	53	60	65	74	73	75	78	69	82
HBFX 56 T4/T8 1,6/0,4kW (A5:6) (750 RPM - 40°)	Inlet	41	48	53	60	60	61	63	55	68
HBFX 56 T4/T8 1,6/0,4kW (A5:6) (750 RPM - 43°)	Inlet	43	50	55	61	61	62	64	55	69
HBFX 56 T4/T8 1,6/0,4kW (A5:6) (1500 RPM - 40°)	Inlet	56	63	68	76	75	76	79	70	83
HBFX 56 T4/T8 1,6/0,4kW (A5:6) (1500 RPM - 43°)	Inlet	58	65	70	76	76	77	79	70	84
HBFX 63 T4/T8 0,8/0,2kW (A5:6) (750 RPM - 25°)	Inlet	42	51	56	65	65	64	65	60	71
HBFX 63 T4/T8 0,8/0,2kW (A5:6) (1500 RPM - 25°)	Inlet	57	66	71	80	80	79	80	75	86
HBFX 63 T4/T8 1,2/0,3kW (A5:6) (750 RPM - 30°)	Inlet	45	53	59	65	65	64	67	62	72
HBFX 63 T4/T8 1,2/0,3kW (A5:6) (1500 RPM - 30°)	Inlet	60	68	74	80	80	79	82	77	87
HBFX 63 T4/T8 1,6/0,4kW (A5:6) (750 RPM - 35°)	Inlet	43	52	57	60	61	60	64	58	68
HBFX 63 T4/T8 1,6/0,4kW (A5:6) (1500 RPM - 35°)	Inlet	59	67	72	75	76	76	79	73	83

		Sound power Lw dB (A)								
Model		63 Hz	125 Hz	250 Hz	500 Hz	1000 Hz	2000 Hz	4000 Hz	8000 Hz	Total
HBFX 63 T4/T8 1,6/0,4kW (A5:6) (750 RPM - 33°)	Inlet	44	52	58	62	63	62	65	60	70
HBFX 63 T4/T8 1,6/0,4kW (A5:6) (1500 RPM - 33°)	Inlet	59	68	73	77	78	77	80	75	85
HBFX 63 T4/T8 2,2/0,37kW (A5:6) (750 RPM - 37°)	Inlet	44	52	57	61	62	62	64	58	69
HBFX 63 T4/T8 2,2/0,37kW (A5:6) (750 RPM - 40°)	Inlet	45	52	57	62	62	63	65	58	70
HBFX 63 T4/T8 2,2/0,37kW (A5:6) (1500 RPM - 40°)	Inlet	60	67	72	77	78	78	80	73	85
HBFX 63 T4/T8 2,2/0,37kW (A5:6) (1500 RPM - 37°)	Inlet	59	67	72	76	77	77	79	73	84
HBFX 71 T4/T8 0,8/0,2kW (A5:6) (750 RPM - 20°)	Inlet	40	51	56	71	70	67	69	61	76
HBFX 71 T4/T8 0,8/0,2kW (A5:6) (1500 RPM - 20°)	Inlet	55	66	71	86	85	82	84	76	91
HBFX 71 T4/T8 1,2/0,3kW (A5:6) (750 RPM - 25°)	Inlet	44	51	56	69	68	67	69	60	75
HBFX 71 T4/T8 1,2/0,3kW (A5:6) (1500 RPM - 25°)	Inlet	59	67	72	84	84	82	84	75	90
HBFX 71 T4/T8 1,6/0,4kW (A5:6) (750 RPM - 30°)	Inlet	46	53	58	67	67	68	69	58	74
HBFX 71 T4/T8 1,6/0,4kW (A5:6) (1500 RPM - 30°)	Inlet	61	68	73	82	82	83	84	73	89
HBFX 71 T4/T8 2,2/0,37kW (A5:6) (750 RPM - 35°)	Inlet	47	54	59	61	65	67	68	57	72
HBFX 71 T4/T8 2,2/0,37kW (A5:6) (750 RPM - 33°)	Inlet	46	53	58	64	66	68	68	58	73
HBFX 71 T4/T8 2,2/0,37kW (A5:6) (1500 RPM - 35°)	Inlet	62	69	74	76	80	82	83	72	87
HBFX 71 T4/T8 2,2/0,37kW (A5:6) (1500 RPM - 33°)	Inlet	62	69	74	79	81	83	84	73	88
HBFX 71 T4/T8 3/0,55kW (A5:6) (750 RPM - 40°)	Inlet	52	58	64	66	69	70	71	61	76
HBFX 71 T4/T8 3/0,55kW (A5:6) (750 RPM - 37°)	Inlet	50	56	62	64	67	69	70	59	74
HBFX 71 T4/T8 3/0,55kW (A5:6) (1500 RPM - 40°)	Inlet	67	73	79	81	84	85	86	76	91
HBFX 71 T4/T8 3/0,55kW (A5:6) (1500 RPM - 37°)	Inlet	65	71	77	79	82	84	85	74	89
HBFX 80 T4/T8 3/0,55kW (A5:6) (750 RPM - 35°)	Inlet	47	54	59	64	67	67	71	61	74
HBFX 80 T4/T8 3/0,55kW (A5:6) (1500 RPM - 35°)	Inlet	62	69	74	79	82	82	86	76	89
HBFX 80 T4/T8 3/0,55kW (A5:6) (750 RPM - 33°)	Inlet	48	55	60	66	69	69	73	64	76

		Sound power Lw dB (A)								
Model		63 Hz	125 Hz	250 Hz	500 Hz	1000 Hz	2000 Hz	4000 Hz	8000 Hz	Total
HBFX 80 T4/T8 3/0,55kW (A5:6) (1500 RPM - 33°)	Inlet	63	70	75	81	85	84	88	80	91
HBFX 80 T4/T8 3/0,55kW (A5:6) (1500 RPM - 30°)	Inlet	64	71	76	83	87	86	90	83	94
HBFX 80 T4/T8 3/0,55kW (A5:6) (750 RPM - 30°)	Inlet	49	56	61	68	72	71	74	68	79
HBFX 80 T4/T8 4/0,75kW (A5:6) (750 RPM - 37°)	Inlet	49	56	61	65	68	68	71	61	75
HBFX 80 T4/T8 4/0,75kW (A5:6) (1500 RPM - 37°)	Inlet	64	71	76	80	83	83	86	76	90
HBFX 80 T4/T8 4/0,75kW (A5:6) (750 RPM - 40°)	Inlet	51	58	63	67	69	69	70	61	76
HBFX 80 T4/T8 4/0,75kW (A5:6) (1500 RPM - 40°)	Inlet	66	73	78	82	84	84	86	76	91
HBFX 90 T4/T8 2,8/0,7kW (A3:4) (1420 RPM - 22°)	Inlet	61	69	74	83	87	87	86	77	92
HBFX 90 T4/T8 2,8/0,7kW (A3:4) (1420 RPM - 20°)	Inlet	57	68	73	84	88	88	86	78	93
HBFX 90 T4/T8 2,8/0,7kW (A3:4) (720 RPM - 22°)	Inlet	45	53	58	67	71	71	70	62	76
HBFX 90 T4/T8 2,8/0,7kW (A3:4) (720 RPM - 20°)	Inlet	41	52	57	68	72	72	70	62	77
HBFX 90 T4/T8 4/0,75kW (A3:4) (1420 RPM - 26°)	Inlet	64	71	76	83	85	85	84	76	91
HBFX 90 T4/T8 4/0,75kW (A3:4) (1420 RPM - 24°)	Inlet	63	70	75	83	86	86	85	77	91
HBFX 90 T4/T8 4/0,75kW (A3:4) (720 RPM - 26°)	Inlet	48	55	60	67	69	69	68	60	75
HBFX 90 T4/T8 4/0,75kW (A3:4) (720 RPM - 24°)	Inlet	47	54	59	67	70	70	69	61	75
HBFX 90 T4/T8 5,5/1,1kW (A3:4) (1420 RPM - 30°)	Inlet	66	73	78	83	83	83	83	75	89
HBFX 90 T4/T8 5,5/1,1kW (A3:4) (1420 RPM - 28°)	Inlet	65	72	77	83	84	84	84	76	90
HBFX 90 T4/T8 5,5/1,1kW (A3:4) (1420 RPM - 32°)	Inlet	66	73	78	82	83	83	83	75	89
HBFX 90 T4/T8 5,5/1,1kW (A3:4) (720 RPM - 32°)	Inlet	50	57	62	66	67	67	67	59	73
HBFX 90 T4/T8 5,5/1,1kW (A3:4) (720 RPM - 30°)	Inlet	51	58	63	67	67	67	67	59	74
HBFX 90 T4/T8 5,5/1,1kW (A3:4) (720 RPM - 28°)	Inlet	49	56	61	67	68	68	68	60	74
HBFX 90 T4/T8 5,5/1,1kW (A3:8) (1420 RPM - 22°)	Inlet	69	80	88	90	92	87	88	78	97
HBFX 90 T4/T8 5,5/1,1kW (A3:8) (1420 RPM - 20°)	Inlet	69	81	90	91	93	87	88	78	98

		Sound power Lw dB (A)								
Model		63 Hz	125 Hz	250 Hz	500 Hz	1000 Hz	2000 Hz	4000 Hz	8000 Hz	Total
HBFX 90 T4/T8 5,5/1,1kW (A3:8) (720 RPM - 22°)	Inlet	53	64	72	74	76	72	72	62	81
HBFX 90 T4/T8 5,5/1,1kW (A3:8) (720 RPM - 20°)	Inlet	53	65	74	75	77	71	72	62	82
HBFX 90 T4/T8 7,5/1,5kW (A3:4) (1420 RPM - 34°)	Inlet	65	72	77	81	83	84	82	74	89
HBFX 90 T4/T8 7,5/1,5kW (A3:4) (1420 RPM - 38°)	Inlet	67	74	79	82	85	84	83	76	91
HBFX 90 T4/T8 7,5/1,5kW (A3:4) (1420 RPM - 36°)	Inlet	66	73	78	81	84	84	82	74	90
HBFX 90 T4/T8 7,5/1,5kW (A3:4) (1420 RPM - 32°)	Inlet	66	73	78	82	83	83	83	75	89
HBFX 90 T4/T8 7,5/1,5kW (A3:4) (720 RPM - 38°)	Inlet	51	58	63	66	69	69	67	60	75
HBFX 90 T4/T8 7,5/1,5kW (A3:4) (720 RPM - 36°)	Inlet	50	57	62	66	68	68	67	58	74
HBFX 90 T4/T8 7,5/1,5kW (A3:4) (720 RPM - 34°)	Inlet	50	57	62	66	67	68	66	58	73
HBFX 90 T4/T8 7,5/1,5kW (A3:4) (720 RPM - 32°)	Inlet	50	57	62	66	67	67	67	59	73
HBFX 90 T4/T8 7,5/1,5kW (A3:8) (1420 RPM - 28°)	Inlet	70	76	82	87	89	88	87	79	94
HBFX 90 T4/T8 7,5/1,5kW (A3:8) (1420 RPM - 26°)	Inlet	70	78	84	88	90	88	88	79	95
HBFX 90 T4/T8 7,5/1,5kW (A3:8) (1420 RPM - 24°)	Inlet	69	79	86	89	91	88	88	78	96
HBFX 90 T4/T8 7,5/1,5kW (A3:8) (720 RPM - 28°)	Inlet	54	60	66	71	73	72	71	63	79
HBFX 90 T4/T8 7,5/1,5kW (A3:8) (720 RPM - 26°)	Inlet	54	62	68	72	74	72	72	63	79
HBFX 90 T4/T8 7,5/1,5kW (A3:8) (720 RPM - 24°)	Inlet	54	63	70	73	75	72	72	63	80
HBFX 90 T4/T8 11/3kW (A3:4) (1420 RPM - 40°)	Inlet	68	75	80	83	87	85	84	77	91
HBFX 90 T4/T8 11/3kW (A3:4) (720 RPM - 40°)	Inlet	52	59	64	67	71	69	68	61	75
HBFX 90 T4/T8 11/3kW (A3:8) (1420 RPM - 36°)	Inlet	67	74	79	83	87	87	85	77	92
HBFX 90 T4/T8 11/3kW (A3:8) (1420 RPM - 34°)	Inlet	67	74	79	84	87	87	85	77	92
HBFX 90 T4/T8 11/3kW (A3:8) (1420 RPM - 32°)	Inlet	67	74	79	85	87	87	86	78	93
HBFX 90 T4/T8 11/3kW (A3:8) (1420 RPM - 30°)	Inlet	68	75	80	86	88	88	87	79	94
HBFX 90 T4/T8 11/3kW (A3:8) (720 RPM - 36°)	Inlet	51	58	63	67	71	71	69	61	76

		Sound power Lw dB (A)								
Model		63 Hz	125 Hz	250 Hz	500 Hz	1000 Hz	2000 Hz	4000 Hz	8000 Hz	Total
HBFX 90 T4/T8 11/3kW (A3:8) (720 RPM - 34°)	Inlet	51	58	63	68	71	71	69	61	76
HBFX 90 T4/T8 11/3kW (A3:8) (720 RPM - 32°)	Inlet	52	59	64	69	71	72	70	62	77
HBFX 90 T4/T8 11/3kW (A3:8) (720 RPM - 30°)	Inlet	52	59	64	70	72	72	71	63	78
HBFX 90 T4/T8 14/3,5kW (A3:8) (1420 RPM - 40°)	Inlet	71	78	83	84	88	87	84	78	93
HBFX 90 T4/T8 14/3,5kW (A3:8) (1420 RPM - 38°)	Inlet	69	76	81	84	87	87	84	77	92
HBFX 90 T4/T8 14/3,5kW (A3:8) (720 RPM - 40°)	Inlet	55	62	67	68	72	71	68	62	77
HBFX 90 T4/T8 14/3,5kW (A3:8) (720 RPM - 38°)	Inlet	53	60	65	68	71	71	69	61	77
HBFX 100 T4/T8 5,5/1,1kW (A3:4) (1420 RPM - 26°)	Inlet	67	75	81	87	90	91	93	88	97
HBFX 100 T4/T8 5,5/1,1kW (A3:4) (1420 RPM - 24°)	Inlet	67	76	81	87	91	92	93	89	98
HBFX 100 T4/T8 5,5/1,1kW (A3:4) (1420 RPM - 22°)	Inlet	66	76	82	88	91	92	93	90	98
HBFX 100 T4/T8 5,5/1,1kW (A3:4) (1420 RPM - 20°)	Inlet	66	76	81	88	91	92	93	90	98
HBFX 100 T4/T8 5,5/1,1kW (A3:4) (720 RPM - 26°)	Inlet	51	59	65	71	74	75	77	72	82
HBFX 100 T4/T8 5,5/1,1kW (A3:4) (720 RPM - 24°)	Inlet	51	60	66	72	75	76	77	73	82
HBFX 100 T4/T8 5,5/1,1kW (A3:4) (720 RPM - 22°)	Inlet	50	60	66	72	76	76	77	74	82
HBFX 100 T4/T8 5,5/1,1kW (A3:4) (720 RPM - 20°)	Inlet	50	60	66	72	76	76	77	74	82
HBFX 100 T4/T8 7,5/1,5kW (A3:4) (1420 RPM - 30°)	Inlet	68	74	81	86	90	91	93	86	97
HBFX 100 T4/T8 7,5/1,5kW (A3:4) (1420 RPM - 28°)	Inlet	67	75	81	86	90	91	93	87	97
HBFX 100 T4/T8 7,5/1,5kW (A3:4) (720 RPM - 30°)	Inlet	52	59	65	70	74	75	77	70	81
HBFX 100 T4/T8 7,5/1,5kW (A3:4) (720 RPM - 28°)	Inlet	51	59	65	71	74	75	77	71	81
HBFX 100 T4/T8 7,5/1,5kW (A3:8) (1420 RPM - 20°)	Inlet	72	81	92	102	100	99	100	95	107
HBFX 100 T4/T8 7,5/1,5kW (A3:8) (720 RPM - 20°)	Inlet	56	65	76	86	84	83	84	79	91
HBFX 100 T4/T8 11/3kW (A3:4) (1420 RPM - 38°)	Inlet	68	74	81	86	89	90	92	85	96
HBFX 100 T4/T8 11/3kW (A3:4) (1420 RPM - 36°)	Inlet	69	73	81	86	88	90	91	85	96

Sound power Lw dB (A)										
Model		63 Hz	125 Hz	250 Hz	500 Hz	1000 Hz	2000 Hz	4000 Hz	8000 Hz	Total
HBFX 100 T4/T8 11/3kW (A3:4) (1420 RPM - 34°)	Inlet	69	73	81	85	88	90	91	85	96
HBFX 100 T4/T8 11/3kW (A3:4) (1420 RPM - 32°)	Inlet	68	74	81	86	89	90	92	86	96
HBFX 100 T4/T8 11/3kW (A3:4) (720 RPM - 38°)	Inlet	52	58	65	70	73	74	76	69	80
HBFX 100 T4/T8 11/3kW (A3:4) (720 RPM - 36°)	Inlet	53	57	65	70	72	74	75	69	80
HBFX 100 T4/T8 11/3kW (A3:4) (720 RPM - 34°)	Inlet	53	57	65	69	72	74	76	69	80
HBFX 100 T4/T8 11/3kW (A3:4) (720 RPM - 32°)	Inlet	52	58	65	70	73	74	76	70	80
HBFX 100 T4/T8 11/3kW (A3:8) (1420 RPM - 28°)	Inlet	72	79	87	93	96	95	96	91	102
HBFX 100 T4/T8 11/3kW (A3:8) (1420 RPM - 24°)	Inlet	72	79	89	97	97	97	98	93	104
HBFX 100 T4/T8 11/3kW (A3:8) (1420 RPM - 22°)	Inlet	72	80	91	100	99	98	99	94	106
HBFX 100 T4/T8 11/3kW (A3:8) (1420 RPM - 26°)	Inlet	72	79	88	95	96	96	97	92	103
HBFX 100 T4/T8 11/3kW (A3:8) (720 RPM - 28°)	Inlet	56	63	71	77	80	80	80	75	86
HBFX 100 T4/T8 11/3kW (A3:8) (720 RPM - 26°)	Inlet	56	63	72	79	80	80	81	76	87
HBFX 100 T4/T8 11/3kW (A3:8) (720 RPM - 24°)	Inlet	56	64	73	81	82	81	82	77	88
HBFX 100 T4/T8 11/3kW (A3:8) (720 RPM - 22°)	Inlet	56	64	75	84	83	82	83	78	90
HBFX 100 T4/T8 14/3,5kW (A3:4) (1420 RPM - 40°)	Inlet	68	75	81	87	90	91	92	86	97
HBFX 100 T4/T8 14/3,5kW (A3:4) (720 RPM - 40°)	Inlet	52	59	66	71	75	75	76	70	81
HBFX 100 T4/T8 14/3,5kW (A3:8) (1420 RPM - 32°)	Inlet	71	79	84	90	93	94	95	89	100
HBFX 100 T4/T8 14/3,5kW (A3:8) (1420 RPM - 30°)	Inlet	72	79	86	91	95	95	96	90	101
HBFX 100 T4/T8 14/3,5kW (A3:8) (720 RPM - 32°)	Inlet	55	63	68	74	77	78	79	73	84
HBFX 100 T4/T8 14/3,5kW (A3:8) (720 RPM - 30°)	Inlet	56	63	70	75	79	79	80	74	85
HBFX 100 T4/T8 17/4,3kW (A3:8) (1420 RPM - 36°)	Inlet	70	77	82	87	91	93	94	87	99
HBFX 100 T4/T8 17/4,3kW (A3:8) (1420 RPM - 34°)	Inlet	71	78	83	88	92	93	94	88	99
HBFX 100 T4/T8 17/4,3kW (A3:8) (720 RPM - 36°)	Inlet	54	61	66	71	75	77	78	72	83

		Sound power Lw dB (A)								
Model		63 Hz	125 Hz	250 Hz	500 Hz	1000 Hz	2000 Hz	4000 Hz	8000 Hz	Total
HBFX 100 T4/T8 17/4,3kW (A3:8) (720 RPM - 34°)	Inlet	55	62	67	72	76	77	78	72	83
HBFX 100 T4/T8 20/5kW (A3:8) (1420 RPM - 38°)	Inlet	71	78	83	88	92	94	94	88	99
HBFX 100 T4/T8 20/5kW (A3:8) (1420 RPM - 40°)	Inlet	71	79	84	89	92	94	95	89	100
HBFX 100 T4/T8 20/5kW (A3:8) (720 RPM - 40°)	Inlet	56	63	68	73	76	78	79	73	84
HBFX 100 T4/T8 20/5kW (A3:8) (720 RPM - 38°)	Inlet	55	62	67	72	76	78	78	72	83
HBFX 112 T4/T8 5,5/1,1kW (A3:4) (1420 RPM - 20°)	Inlet	66	78	83	90	94	94	96	92	101
HBFX 112 T4/T8 5,5/1,1kW (A3:4) (720 RPM - 20°)	Inlet	50	62	67	74	78	78	80	76	85
HBFX 112 T4/T8 7,5/1,5kW (A3:4) (1420 RPM - 22°)	Inlet	68	79	84	90	94	95	96	92	102
HBFX 112 T4/T8 7,5/1,5kW (A3:4) (1420 RPM - 24°)	Inlet	69	78	83	90	93	94	96	91	101
HBFX 112 T4/T8 7,5/1,5kW (A3:4) (720 RPM - 24°)	Inlet	53	62	67	74	77	78	80	75	85
HBFX 112 T4/T8 7,5/1,5kW (A3:4) (720 RPM - 22°)	Inlet	52	63	68	74	78	79	81	76	86
HBFX 112 T4/T8 11/3kW (A3:4) (1420 RPM - 32°)	Inlet	70	77	82	87	91	92	94	87	98
HBFX 112 T4/T8 11/3kW (A3:4) (1420 RPM - 30°)	Inlet	71	78	83	88	92	93	94	88	99
HBFX 112 T4/T8 11/3kW (A3:4) (1420 RPM - 28°)	Inlet	71	78	83	89	92	93	95	89	99
HBFX 112 T4/T8 11/3kW (A3:4) (1420 RPM - 26°)	Inlet	70	78	83	89	93	94	95	90	100
HBFX 112 T4/T8 11/3kW (A3:4) (720 RPM - 32°)	Inlet	55	61	67	72	75	76	78	71	82
HBFX 112 T4/T8 11/3kW (A3:4) (720 RPM - 30°)	Inlet	55	62	67	72	76	77	78	72	83
HBFX 112 T4/T8 11/3kW (A3:4) (720 RPM - 28°)	Inlet	55	62	67	73	76	77	79	73	83
HBFX 112 T4/T8 11/3kW (A3:4) (720 RPM - 26°)	Inlet	54	62	67	73	77	78	79	74	84
HBFX 112 T4/T8 11/3kW (A3:8) (1420 RPM - 20°)	Inlet	73	82	92	101	101	103	103	97	109
HBFX 112 T4/T8 11/3kW (A3:8) (720 RPM - 20°)	Inlet	57	66	76	85	85	87	87	81	93
HBFX 112 T4/T8 14/3,5kW (A3:4) (1420 RPM - 34°)	Inlet	70	76	82	87	90	92	93	86	98
HBFX 112 T4/T8 14/3,5kW (A3:4) (1420 RPM - 36°)	Inlet	71	76	83	87	90	92	93	86	98



		Sound power Lw dB (A)								
Model		63 Hz	125 Hz	250 Hz	500 Hz	1000 Hz	2000 Hz	4000 Hz	8000 Hz	Total
HBFX 112 T4/T8 14/3,5kW (A3:4) (720 RPM - 36°)	Inlet	55	60	67	71	74	76	77	70	82
HBFX 112 T4/T8 14/3,5kW (A3:4) (720 RPM - 34°)	Inlet	54	60	66	71	74	76	77	70	82
HBFX 112 T4/T8 14/3,5kW (A3:8) (1420 RPM - 26°)	Inlet	74	81	89	96	98	100	100	94	106
HBFX 112 T4/T8 14/3,5kW (A3:8) (1420 RPM - 24°)	Inlet	73	81	90	97	99	101	101	95	106
HBFX 112 T4/T8 14/3,5kW (A3:8) (1420 RPM - 22°)	Inlet	73	81	91	99	100	102	102	96	107
HBFX 112 T4/T8 14/3,5kW (A3:8) (720 RPM - 26°)	Inlet	58	65	73	80	83	84	84	78	90
HBFX 112 T4/T8 14/3,5kW (A3:8) (720 RPM - 24°)	Inlet	57	65	74	81	83	85	85	79	90
HBFX 112 T4/T8 14/3,5kW (A3:8) (720 RPM - 22°)	Inlet	57	65	75	83	84	86	86	80	91
HBFX 112 T4/T8 17/4,3kW (A3:4) (1420 RPM - 40°)	Inlet	72	79	84	89	91	93	94	87	99
HBFX 112 T4/T8 17/4,3kW (A3:4) (1420 RPM - 38°)	Inlet	71	77	83	88	91	92	93	87	98
HBFX 112 T4/T8 17/4,3kW (A3:4) (720 RPM - 40°)	Inlet	56	63	68	73	76	77	78	71	83
HBFX 112 T4/T8 17/4,3kW (A3:4) (720 RPM - 38°)	Inlet	55	61	67	72	75	76	78	71	82
HBFX 112 T4/T8 17/4,3kW (A3:8) (1420 RPM - 30°)	Inlet	74	80	87	93	97	99	99	93	104
HBFX 112 T4/T8 17/4,3kW (A3:8) (1420 RPM - 28°)	Inlet	74	81	88	94	98	99	99	94	105
HBFX 112 T4/T8 17/4,3kW (A3:8) (720 RPM - 30°)	Inlet	58	65	72	77	81	83	83	77	88
HBFX 112 T4/T8 17/4,3kW (A3:8) (720 RPM - 28°)	Inlet	58	65	72	78	82	83	83	78	89
HBFX 112 T4/T8 20/5kW (A3:8) (1420 RPM - 32°)	Inlet	74	81	86	91	96	97	97	91	103
HBFX 112 T4/T8 20/5kW (A3:8) (720 RPM - 32°)	Inlet	58	65	70	76	80	81	81	75	87
HBFX 112 T4/T8 28/6,5kW (A3:8) (1420 RPM - 34°)	Inlet	73	80	85	90	94	96	96	89	101
HBFX 112 T4/T8 28/6,5kW (A3:8) (1420 RPM - 40°)	Inlet	74	81	86	90	94	96	95	90	101
HBFX 112 T4/T8 28/6,5kW (A3:8) (1420 RPM - 38°)	Inlet	73	80	85	90	94	96	95	89	101
HBFX 112 T4/T8 28/6,5kW (A3:8) (1420 RPM - 36°)	Inlet	73	80	85	90	93	95	95	89	101
HBFX 112 T4/T8 28/6,5kW (A3:8) (720 RPM - 40°)	Inlet	58	65	70	74	78	80	80	74	85

		Sound power Lw dB (A)								
Model		63 Hz	125 Hz	250 Hz	500 Hz	1000 Hz	2000 Hz	4000 Hz	8000 Hz	Total
HBFX 112 T4/T8 28/6,5kW (A3:8) (720 RPM - 38°)	Inlet	57	64	69	74	78	80	80	73	85
HBFX 112 T4/T8 28/6,5kW (A3:8) (720 RPM - 36°)	Inlet	57	64	69	74	77	79	80	73	85
HBFX 112 T4/T8 28/6,5kW (A3:8) (720 RPM - 34°)	Inlet	57	64	69	74	78	80	80	73	85
HBFX 125 T4/T8 11/3kW (A3:4) (1420 RPM - 22°)	Inlet	75	86	91	98	102	103	105	101	109
HBFX 125 T4/T8 11/3kW (A3:4) (1420 RPM - 20°)	Inlet	72	85	90	98	102	102	104	101	109
HBFX 125 T4/T8 11/3kW (A3:4) (720 RPM - 22°)	Inlet	59	70	75	82	86	87	89	85	93
HBFX 125 T4/T8 11/3kW (A3:4) (720 RPM - 20°)	Inlet	56	69	74	82	86	86	88	85	93
HBFX 125 T4/T8 14/3,5kW (A3:4) (1420 RPM - 26°)	Inlet	76	84	89	94	98	99	101	95	106
HBFX 125 T4/T8 14/3,5kW (A3:4) (1420 RPM - 24°)	Inlet	75	85	90	96	100	101	103	98	107
HBFX 125 T4/T8 14/3,5kW (A3:4) (720 RPM - 26°)	Inlet	60	68	73	78	82	83	85	80	90
HBFX 125 T4/T8 14/3,5kW (A3:4) (720 RPM - 24°)	Inlet	59	69	74	80	84	85	87	82	91
HBFX 125 T4/T8 17/4,3kW (A3:4) (1420 RPM - 28°)	Inlet	75	82	87	93	96	98	99	93	104
HBFX 125 T4/T8 17/4,3kW (A3:4) (1420 RPM - 30°)	Inlet	74	81	86	91	95	96	97	91	102
HBFX 125 T4/T8 17/4,3kW (A3:4) (720 RPM - 30°)	Inlet	58	65	70	75	79	80	81	75	86
HBFX 125 T4/T8 17/4,3kW (A3:4) (720 RPM - 28°)	Inlet	60	67	72	77	80	82	83	77	88
HBFX 125 T4/T8 20/5kW (A3:4) (1420 RPM - 34°)	Inlet	73	80	85	90	93	95	96	88	101
HBFX 125 T4/T8 20/5kW (A3:4) (1420 RPM - 32°)	Inlet	74	81	86	90	94	96	96	90	102
HBFX 125 T4/T8 20/5kW (A3:4) (720 RPM - 34°)	Inlet	58	65	70	74	77	79	80	72	85
HBFX 125 T4/T8 20/5kW (A3:4) (720 RPM - 32°)	Inlet	58	65	70	75	78	80	81	74	86
HBFX 125 T4/T8 20/5kW (A3:8) (1420 RPM - 24°)	Inlet	78	85	92	100	106	108	108	102	113
HBFX 125 T4/T8 20/5kW (A3:8) (1420 RPM - 22°)	Inlet	79	86	93	102	107	110	109	104	114
HBFX 125 T4/T8 20/5kW (A3:8) (1420 RPM - 20°)	Inlet	78	86	93	103	108	111	110	105	115
HBFX 125 T4/T8 20/5kW (A3:8) (720 RPM - 24°)	Inlet	62	70	76	84	90	92	92	86	97

Sound power Lw dB (A)										
Model		63 Hz	125 Hz	250 Hz	500 Hz	1000 Hz	2000 Hz	4000 Hz	8000 Hz	Total
HBFX 125 T4/T8 20/5kW (A3:8) (720 RPM - 22°)	Inlet	63	70	77	86	91	94	93	88	98
HBFX 125 T4/T8 20/5kW (A3:8) (720 RPM - 20°)	Inlet	62	71	78	87	92	95	94	89	99
HBFX 125 T4/T8 28/6,5kW (A3:4) (1420 RPM - 40°)	Inlet	75	82	87	91	93	96	96	89	102
HBFX 125 T4/T8 28/6,5kW (A3:4) (1420 RPM - 38°)	Inlet	74	81	86	91	93	95	96	89	101
HBFX 125 T4/T8 28/6,5kW (A3:4) (1420 RPM - 36°)	Inlet	74	81	86	90	93	95	96	88	101
HBFX 125 T4/T8 28/6,5kW (A3:4) (720 RPM - 40°)	Inlet	59	66	71	75	78	80	80	73	86
HBFX 125 T4/T8 28/6,5kW (A3:4) (720 RPM - 38°)	Inlet	58	65	70	75	77	79	80	73	85
HBFX 125 T4/T8 28/6,5kW (A3:4) (720 RPM - 36°)	Inlet	58	65	70	74	77	79	80	72	85
HBFX 125 T4/T8 28/6,5kW (A3:8) (1420 RPM - 30°)	Inlet	77	83	90	96	101	103	104	97	108
HBFX 125 T4/T8 28/6,5kW (A3:8) (1420 RPM - 28°)	Inlet	78	84	91	97	102	105	105	98	110
HBFX 125 T4/T8 28/6,5kW (A3:8) (1420 RPM - 26°)	Inlet	78	85	91	98	104	106	106	100	111
HBFX 125 T4/T8 28/6,5kW (A3:8) (720 RPM - 30°)	Inlet	62	67	74	80	85	87	88	81	92
HBFX 125 T4/T8 28/6,5kW (A3:8) (720 RPM - 28°)	Inlet	62	68	75	81	86	89	89	82	94
HBFX 125 T4/T8 28/6,5kW (A3:8) (720 RPM - 26°)	Inlet	62	69	75	82	88	90	90	84	95
HBFX 125 T4/T8 37/9,2kW (A3:8) (1420 RPM - 36°)	Inlet	77	83	89	93	96	98	98	91	104
HBFX 125 T4/T8 37/9,2kW (A3:8) (1420 RPM - 34°)	Inlet	77	83	89	94	97	99	100	92	105
HBFX 125 T4/T8 37/9,2kW (A3:8) (1420 RPM - 32°)	Inlet	77	83	89	95	99	102	102	94	107
HBFX 125 T4/T8 37/9,2kW (A3:8) (720 RPM - 36°)	Inlet	61	68	73	77	81	83	82	75	88
HBFX 125 T4/T8 37/9,2kW (A3:8) (720 RPM - 34°)	Inlet	61	68	73	78	81	84	84	76	89
HBFX 125 T4/T8 37/9,2kW (A3:8) (720 RPM - 32°)	Inlet	61	67	73	79	83	86	86	79	91
HBFX 125 T4/T8 44/11kW (A3:8) (1420 RPM - 40°)	Inlet	76	83	88	93	96	98	97	90	103
HBFX 125 T4/T8 44/11kW (A3:8) (1420 RPM - 38°)	Inlet	76	83	88	93	96	98	97	91	104
HBFX 125 T4/T8 44/11kW (A3:8) (720 RPM - 40°)	Inlet	60	67	72	77	80	82	81	74	87

		Sound power Lw dB (A)								
Model		63 Hz	125 Hz	250 Hz	500 Hz	1000 Hz	2000 Hz	4000 Hz	8000 Hz	Total
HBFX 125 T4/T8 44/11kW (A3:8) (720 RPM - 38°)	Inlet	60	67	72	77	80	82	82	75	88