

HH-2



EXTERNAL MOTOR, VARIABLE PITCH BLADES

MANUFACTURING FEATURES:

- Long case fan.
- Transmission ball bearings set inside a sealed cast iron box.
- Cast aluminium impeller with variable pitch angle in origin.
- Polyester powder finishing coat.
- Standard asynchronous squirrel-cage motor with IP-55 protection and Class F insulation. Manufactured with standard voltages: 230V 50Hz in single phase motors and 230/400V 50Hz in three phase motors, up to 4kW and 400/690V 50Hz for higher powers.
- Inspection door.

APPLICATIONS:

Designed for inline installation, they are suitable for:

- Air renewal in buildings and industries.
- Extraction of hot air up to 90°C.
- Maximum working temperature: carried air: 90°C, ambient 60°C.

Rendelhető tartozékok



AC



BAD



INT



JE 45



RA



SFC

UNDER REQUEST:

- Supply impeller (air direction from impeller to motor),
- Reversible impeller.
- Polyamide impeller.
- 60Hz fans and special voltages.
- 2 speed motors.
- Hot-dipped galvanised.
- ATEX fans (HHX-2)

Műszaki adatok

Háromfázisú motor

Cikkszám	Modell	R.P.M.	Névleges áramfelvétel A		Névleges teljesítmény kW	Max. légszállítás m ³ /h	Zajszint dB (A)**	Tömeg kg	Kapcsolási rajz
			230V	400V					
280352106	HH-2 35 T2 0,55kW	2800	2,23	1,29	0,55	4.650	-	31	
280354106	HH-2 35 T4 0,37kW	1370	1,86	1,07	0,37	4.110	-	31	
280402306	HH-2 40 T2 1,1kW	2800	4,05	2,33	1,10	7.710	-	57	
280404306	HH-2 40 T4 0,37kW	1370	1,86	1,07	0,37	5.520	-	52	
280452306	HH-2 45 T2 2,2kW	2840	7,97	4,58	2,20	11.570	-	58	
280454206	HH-2 45 T4 0,37kW	1370	1,86	1,07	0,37	6.530	-	39	
280504106	HH-2 50 T4 0,55kW	1440	2,57	1,49	0,55	8.000	-	55	
280504206	HH-2 50 T4 0,75kW	1410	2,83	1,63	0,75	9.050	-	55	
280564106	HH-2 56 T4 1,1kW	1450	4,33	2,49	1,10	12.750	-	72	
280634106	HH-2 63 T4 1,1kW	1450	4,33	2,49	1,10	15.420	-	83	
280634206	HH-2 63 T4 1,5kW	1450	5,67	3,26	1,50	17.400	-	83	
280714106	HH-2 71 T4 1,1kW	1450	4,33	2,49	1,10	19.130	-	87	
280714206	HH-2 71 T4 1,5kW	1450	5,67	3,26	1,50	21.430	-	87	
280714306	HH-2 71 T4 2,2kW	1435	8,07	4,64	2,20	24.350	-	95	
280804306	HH-2 80 T4 2,2kW	1435	8,07	4,64	2,20	27.870	-	110	
280804406	HH-2 80 T4 3kW	1420	10,7	6,17	3,00	30.970	-	110	
280804506	HH-2 80 T4 4kW	1440	14,5	8,32	4,00	35.180	-	117	
280904406	HH-2 90 T4 4kW	1440	14,5	8,32	4,00	39.970	-	126	
280904506	HH-2 90 T4 5,5kW	1460	-	10,5	5,50	45.370	-	150	

Megjegyzés:

** Total sound pressure level at the point of maximum flow measured in dB(A) in the suction measured in free field at a distance of 6m from the source

Méreték

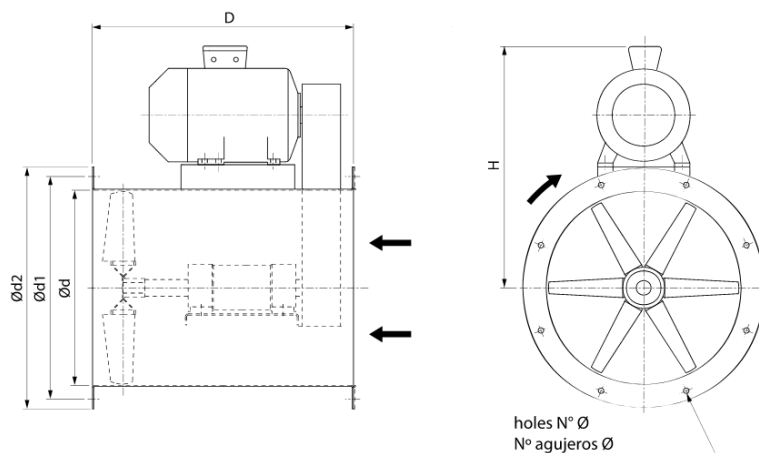

Modell	D	H	N	d	d1	d2	Ø
HH-2 35 T2 0,55kW	475	400	8	355	405	440	12
HH-2 35 T4 0,37kW	475	400	8	355	405	440	12
HH-2 40 T2 1,1kW	475	445	12	400	448	485	12
HH-2 40 T4 0,37kW	475	420	12	400	448	485	12
HH-2 45 T2 2,2kW	475	510	12	450	497	535	12
HH-2 45 T4 0,37kW	475	460	12	450	497	535	12
HH-2 50 T4 0,55kW	560	500	12	500	551	585	14
HH-2 50 T4 0,75kW	560	500	12	500	551	585	14
HH-2 56 T4 1,1kW	560	570	12	560	629	665	14
HH-2 63 T4 1,1kW	740	610	12	630	696	735	14
HH-2 63 T4 1,5kW	740	610	12	630	696	735	14
HH-2 71 T4 1,1kW	740	650	16	710	775	815	14
HH-2 71 T4 1,5kW	740	650	16	710	775	815	14
HH-2 71 T4 2,2kW	740	670	16	710	775	815	14
HH-2 80 T4 2,2kW	740	720	16	800	861	905	14
HH-2 80 T4 3kW	740	720	16	800	861	905	14
HH-2 80 T4 4kW	740	730	16	800	861	905	14
HH-2 90 T4 4kW	800	780	16	900	958	1005	14
HH-2 90 T4 5,5kW	800	820	16	900	958	1005	14

JELLEGGÖRBE

HH-2 35 T2 0,55kW

LÉGSZÁLLÍTÁS - NYOMÁS

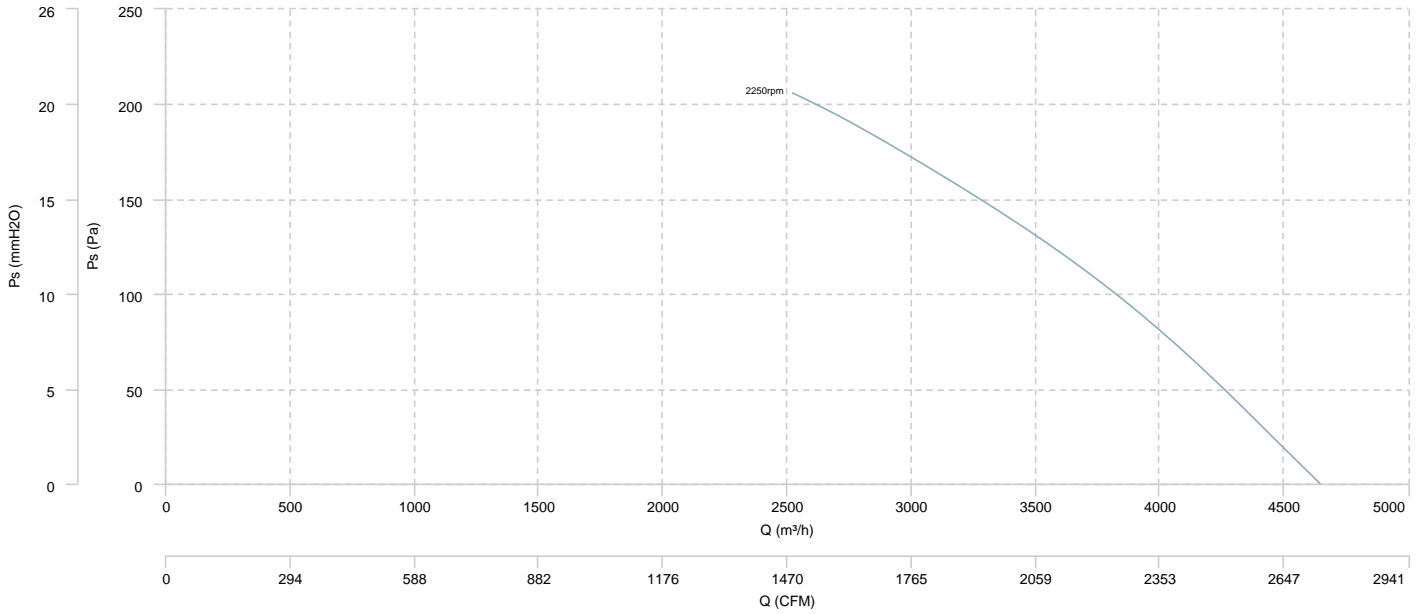

LÉGSZÁLLÍTÁS - MECHANIKAI TELJESÍTMÉNY

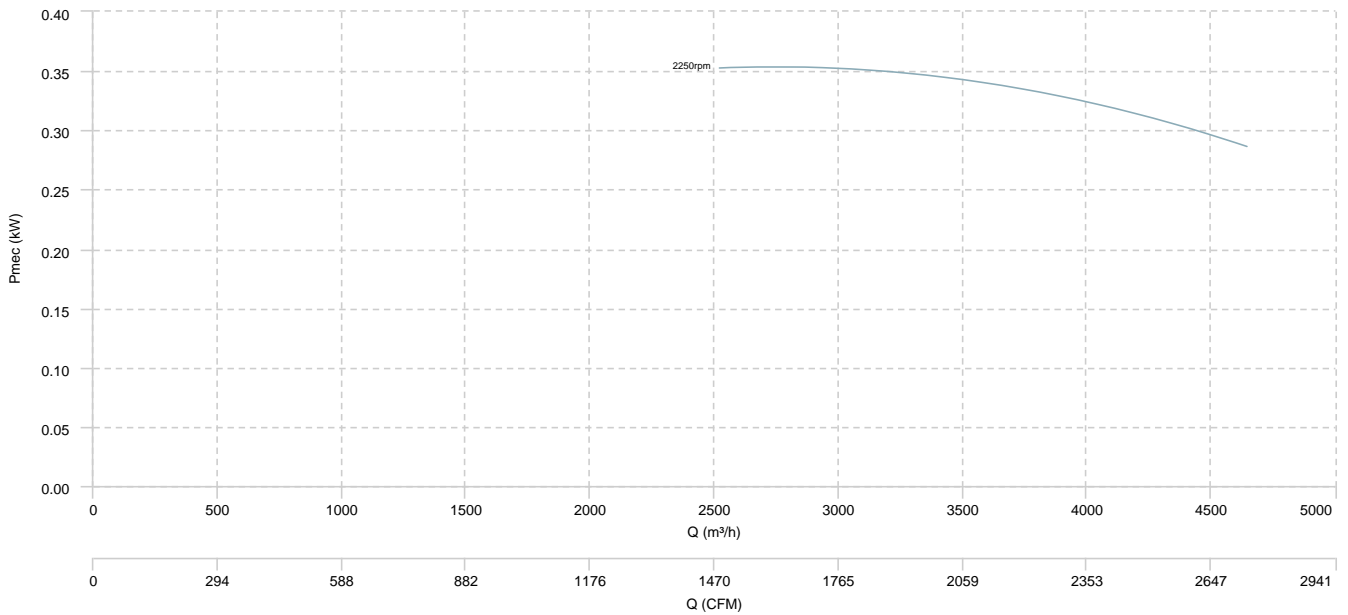

HH-2 35 T4 0,37kW

LÉGSZÁLLÍTÁS - NYOMÁS

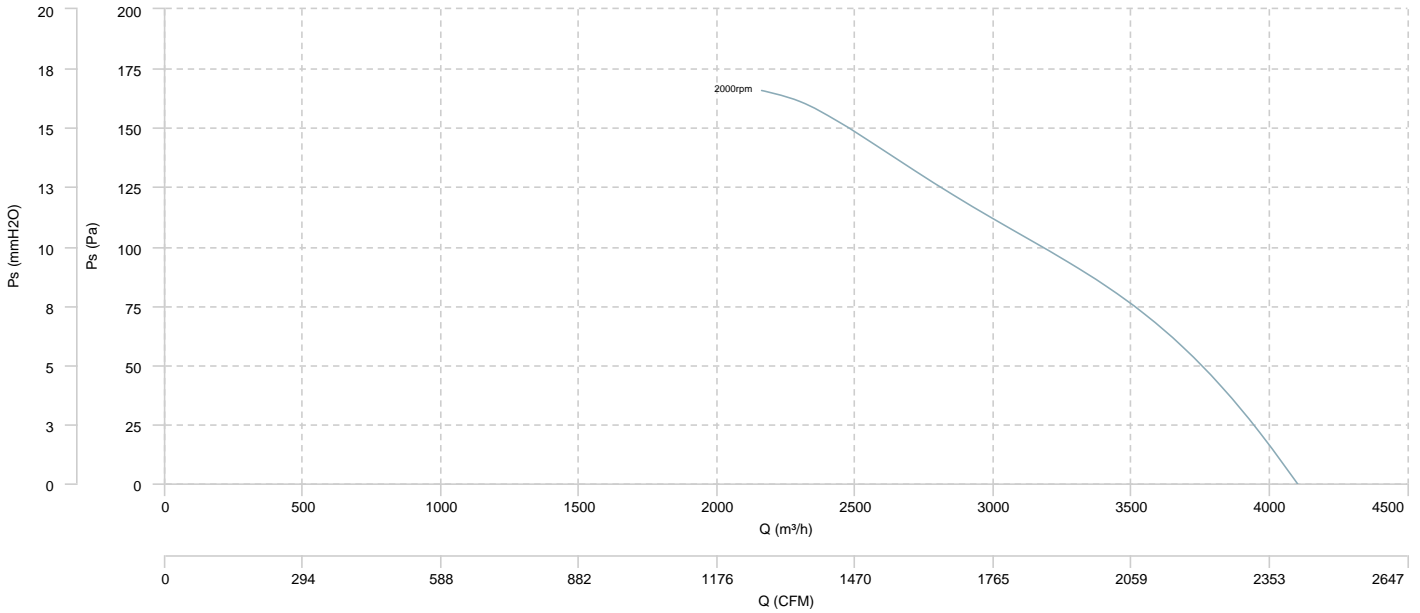

LÉGSZÁLLÍTÁS - MECHANIKAI TELJESÍTMÉNY

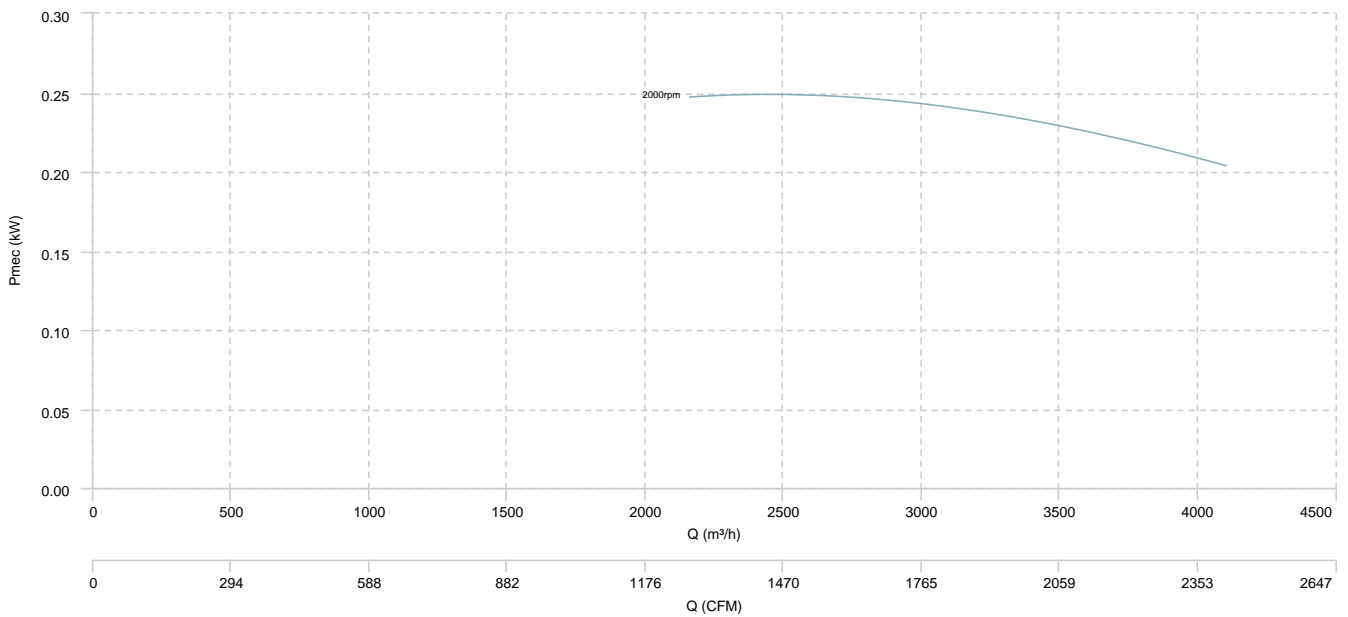

HH-2 40 T2 1,1kW

LÉGSZÁLLÍTÁS - NYOMÁS

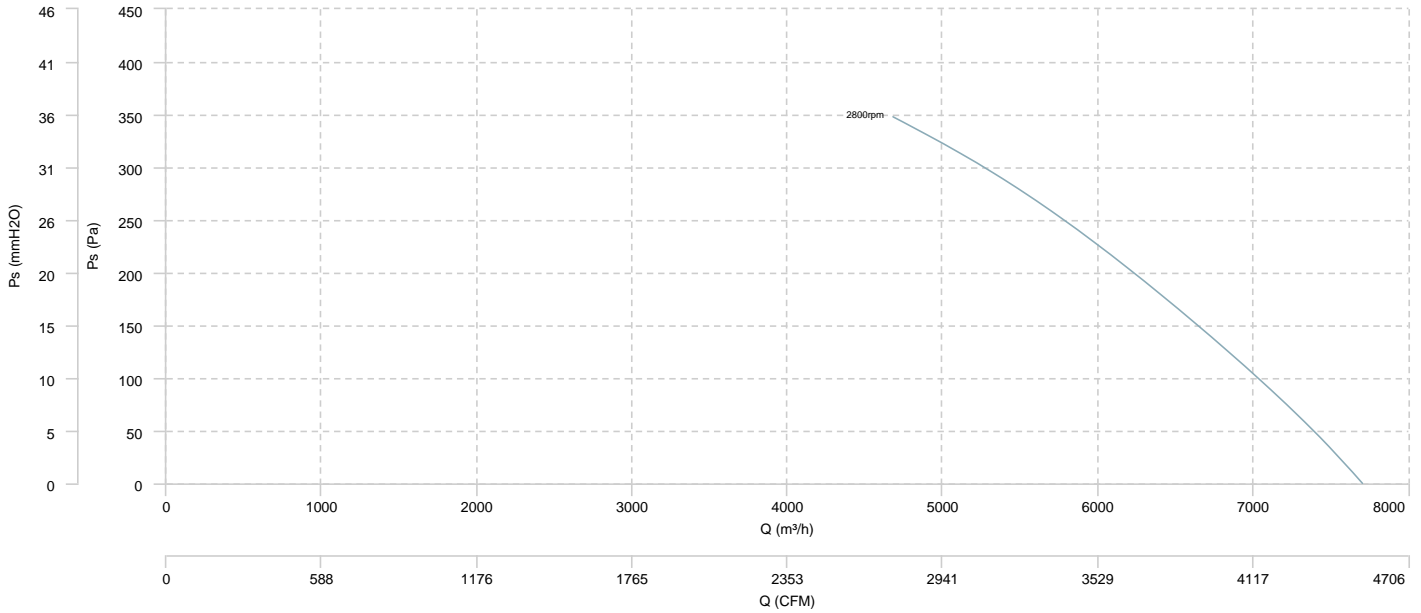

LÉGSZÁLLÍTÁS - MECHANIKAI TELJESÍTMÉNY

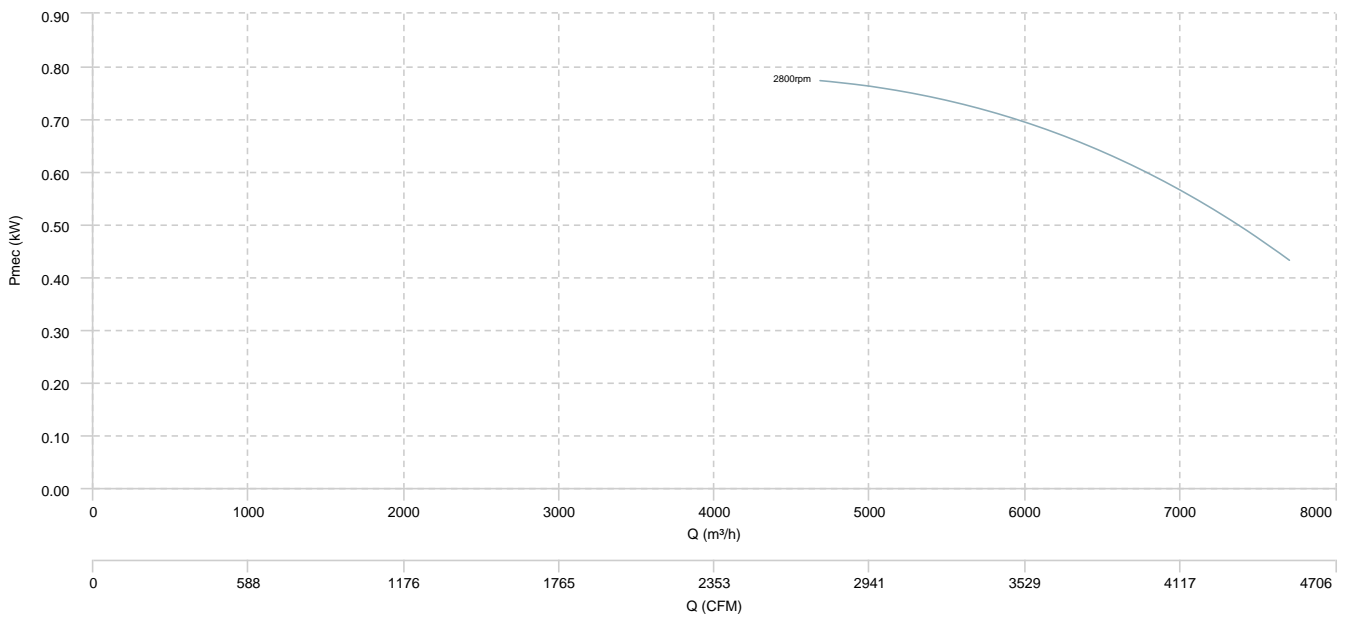

HH-2 40 T4 0,37kW

LÉGSZÁLLÍTÁS - NYOMÁS

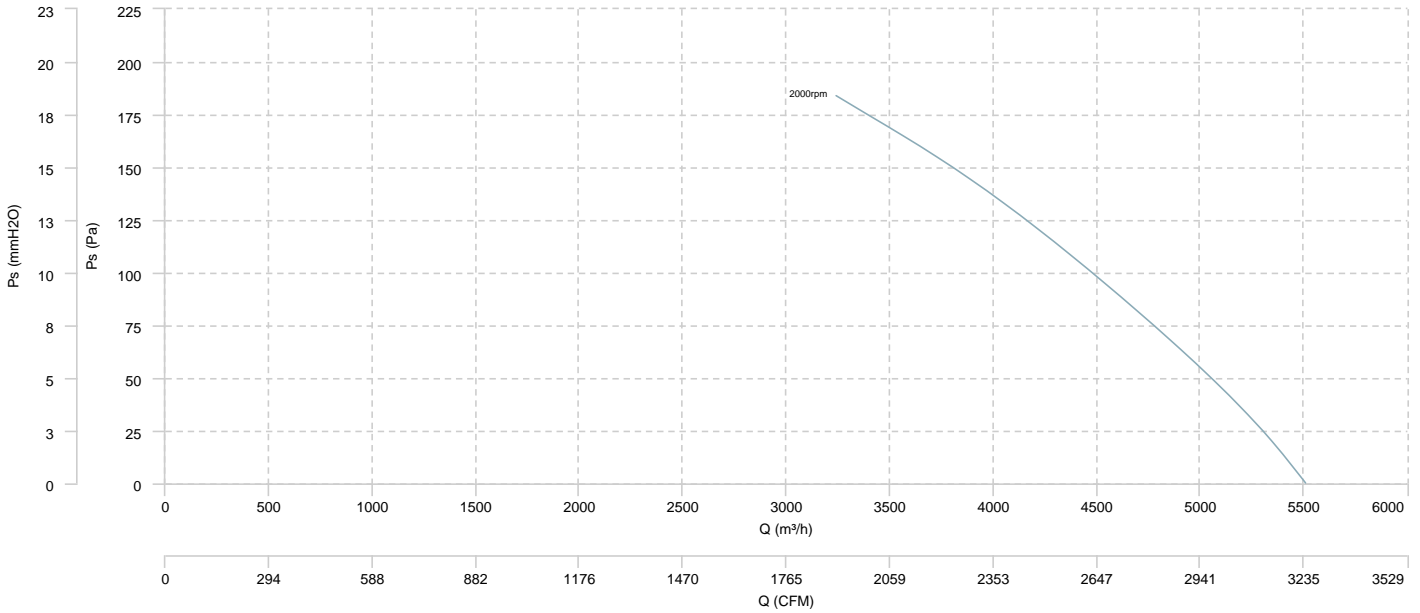

LÉGSZÁLLÍTÁS - MECHANIKAI TELJESÍTMÉNY

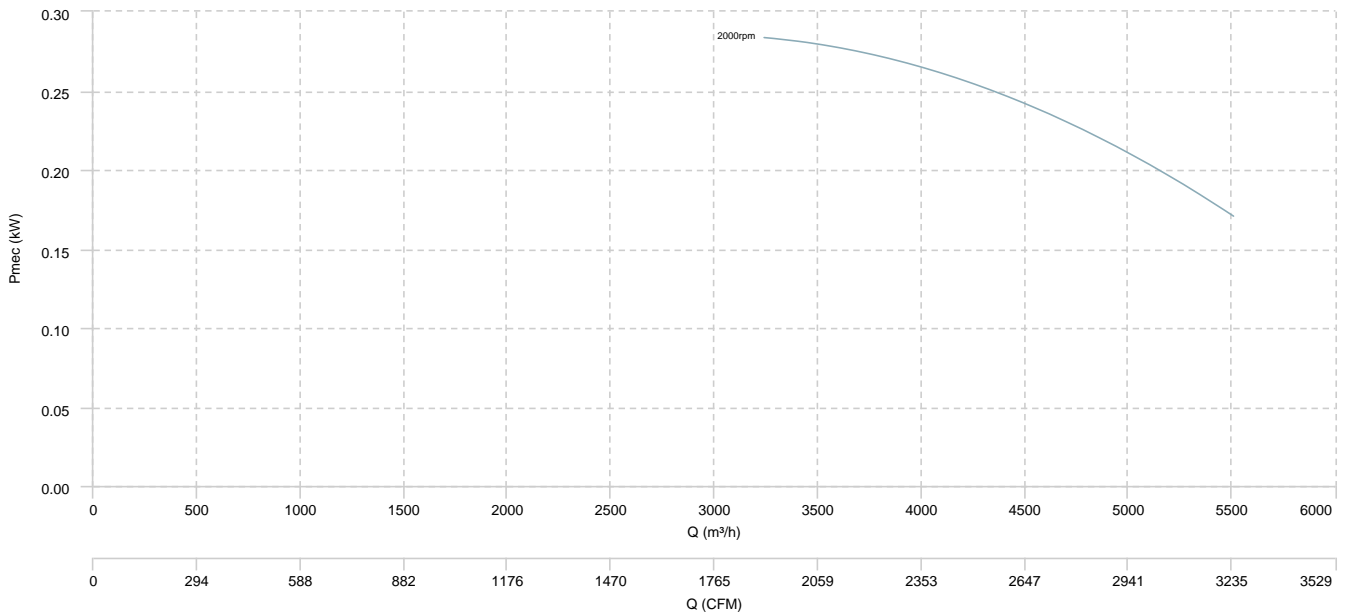

HH-2 45 T2 2,2kW

LÉGSZÁLLÍTÁS - NYOMÁS

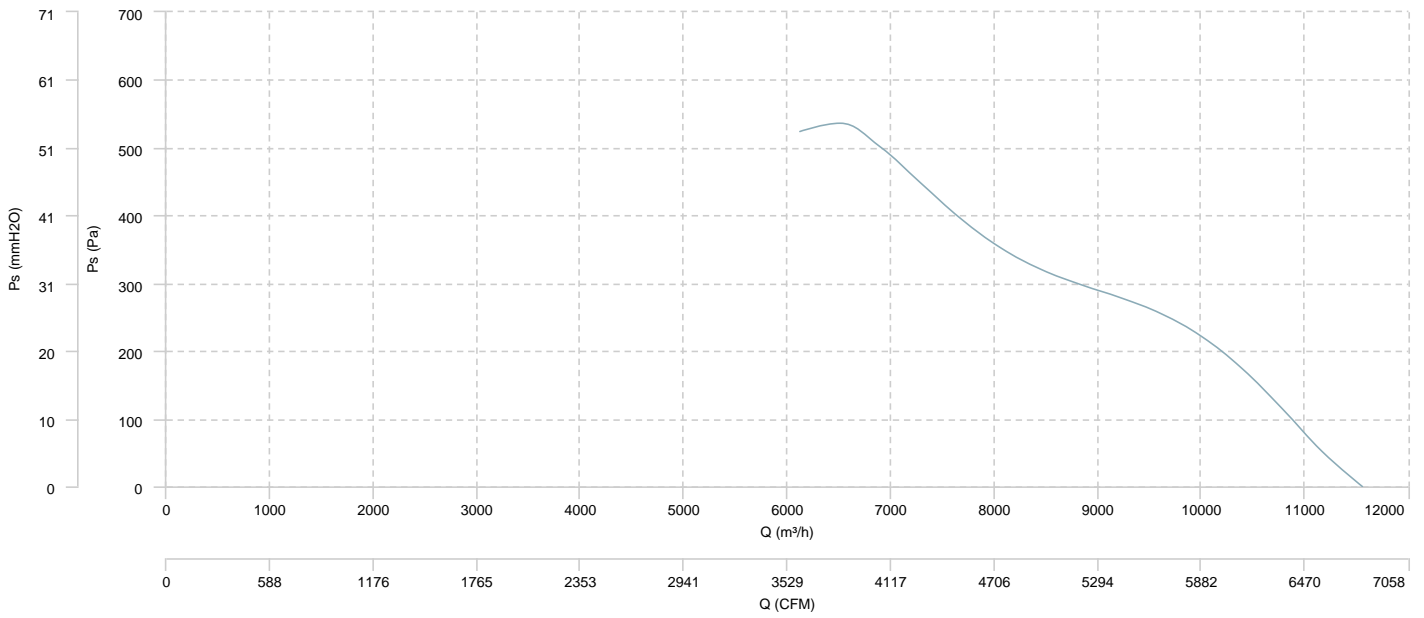

HH-2 45 T4 0,37kW

LÉGSZÁLLÍTÁS - NYOMÁS

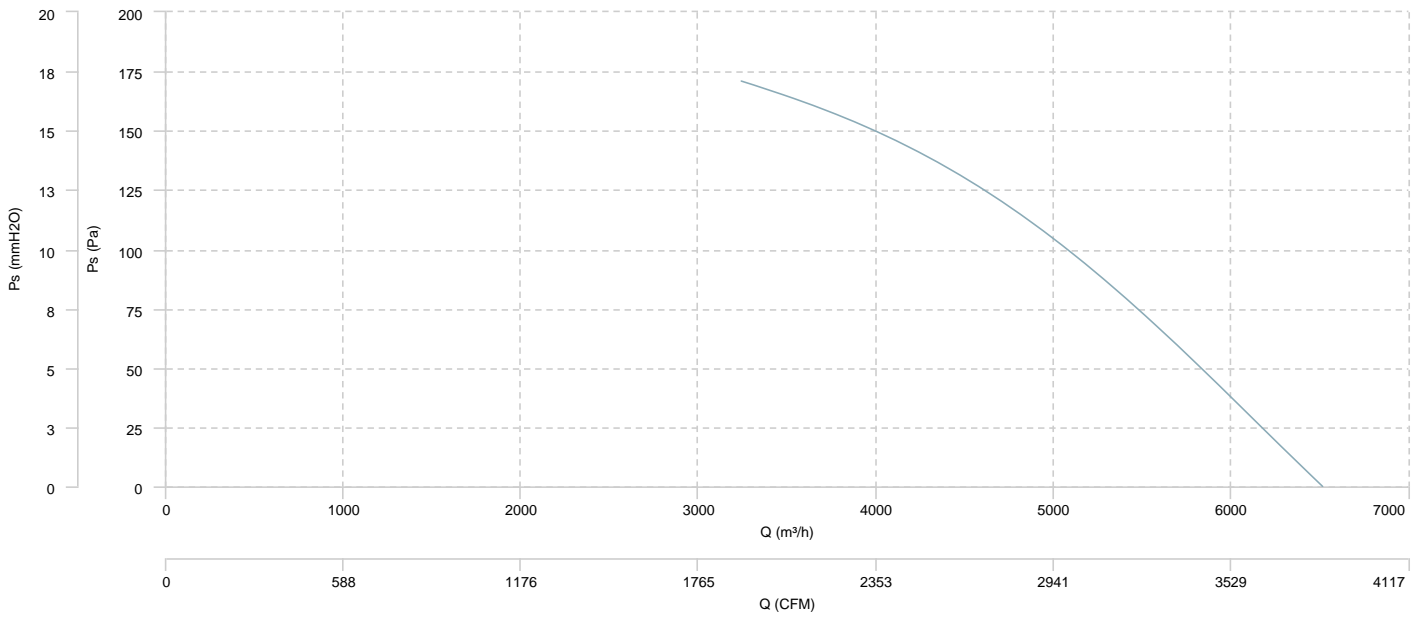

HH-2 50 T4 0,55kW

LÉGSZÁLLÍTÁS - NYOMÁS

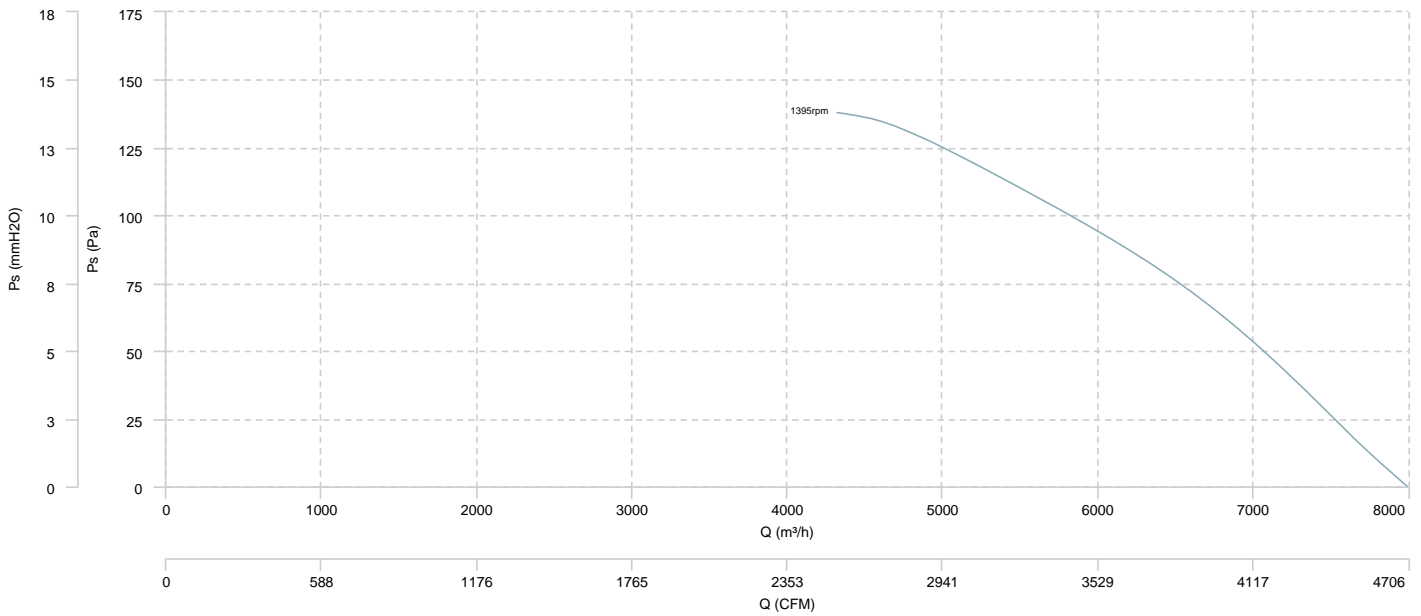

LÉGSZÁLLÍTÁS - MECHANIKAI TELJESÍTMÉNY

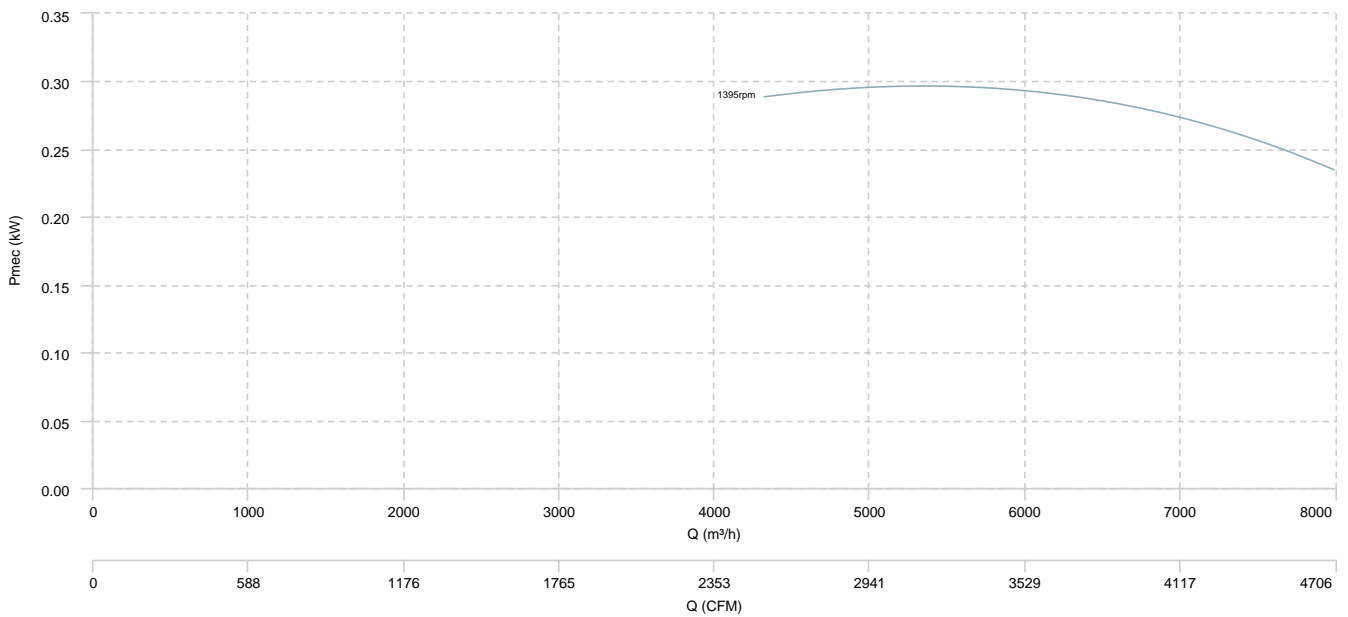

HH-2 50 T4 0,75kW

LÉGSZÁLLÍTÁS - NYOMÁS

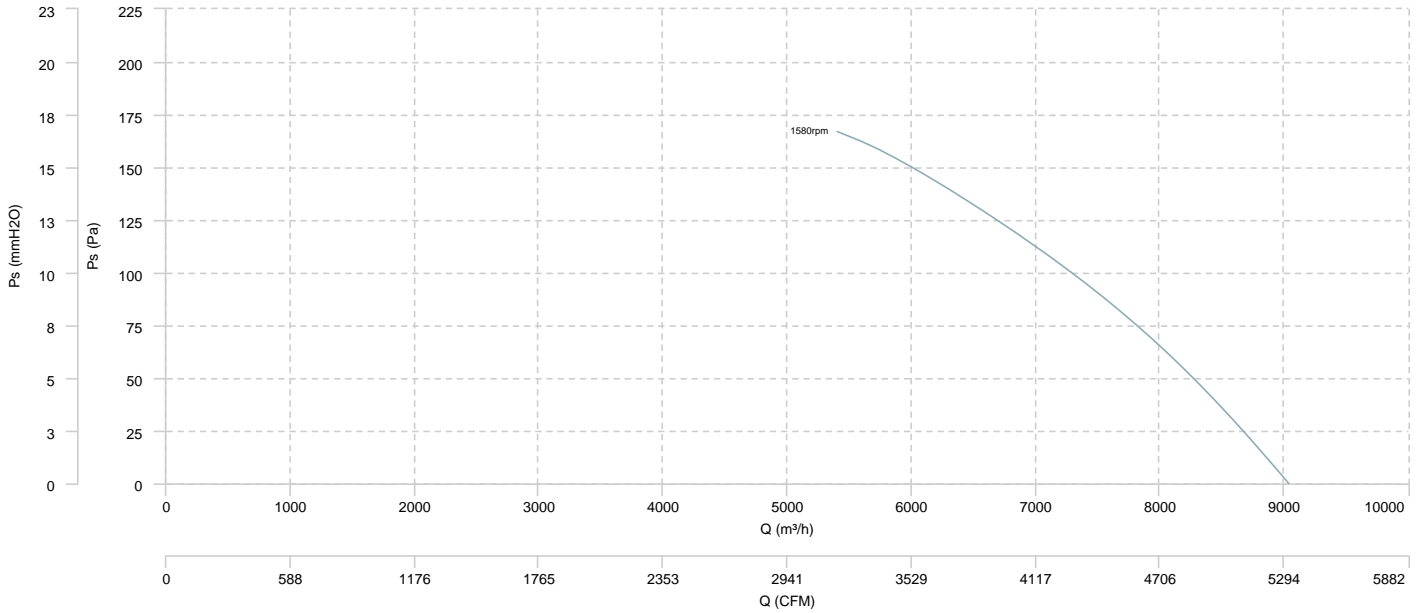

LÉGSZÁLLÍTÁS - MECHANIKAI TELJESÍTMÉNY

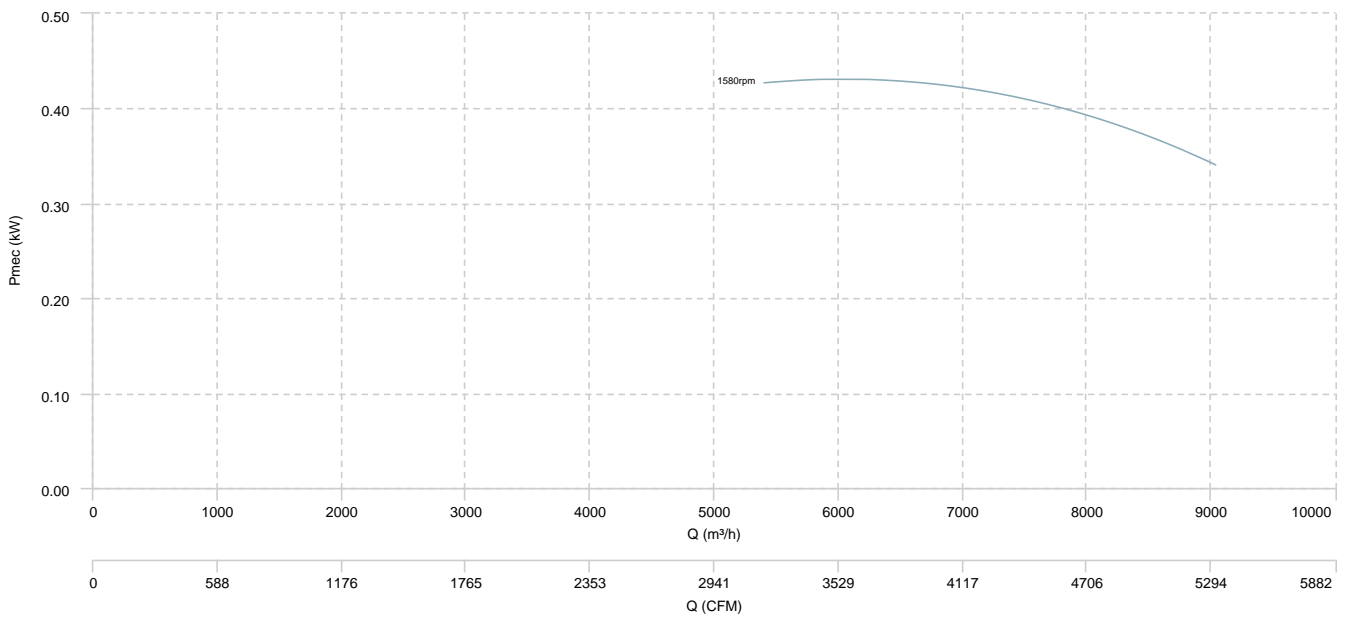

HH-2 56 T4 1,1kW

LÉGSZÁLLÍTÁS - NYOMÁS

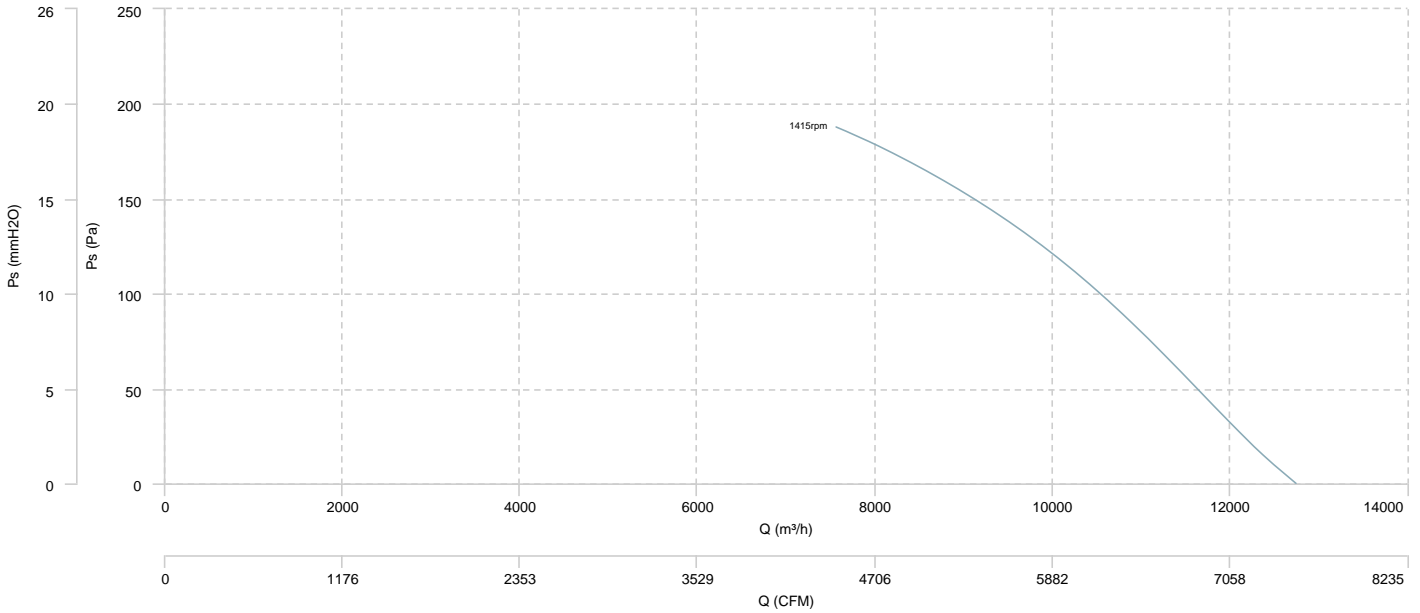

LÉGSZÁLLÍTÁS - MECHANIKAI TELJESÍTMÉNY

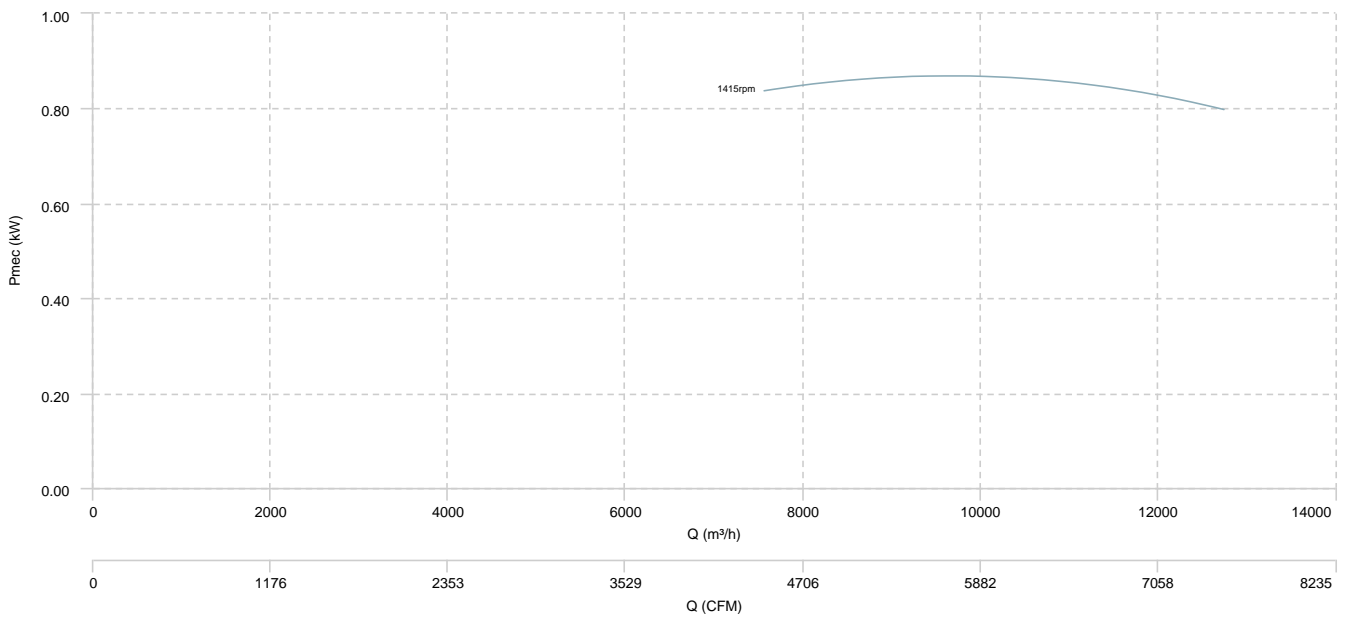

HH-2 63 T4 1,1kW

LÉGSZÁLLÍTÁS - NYOMÁS

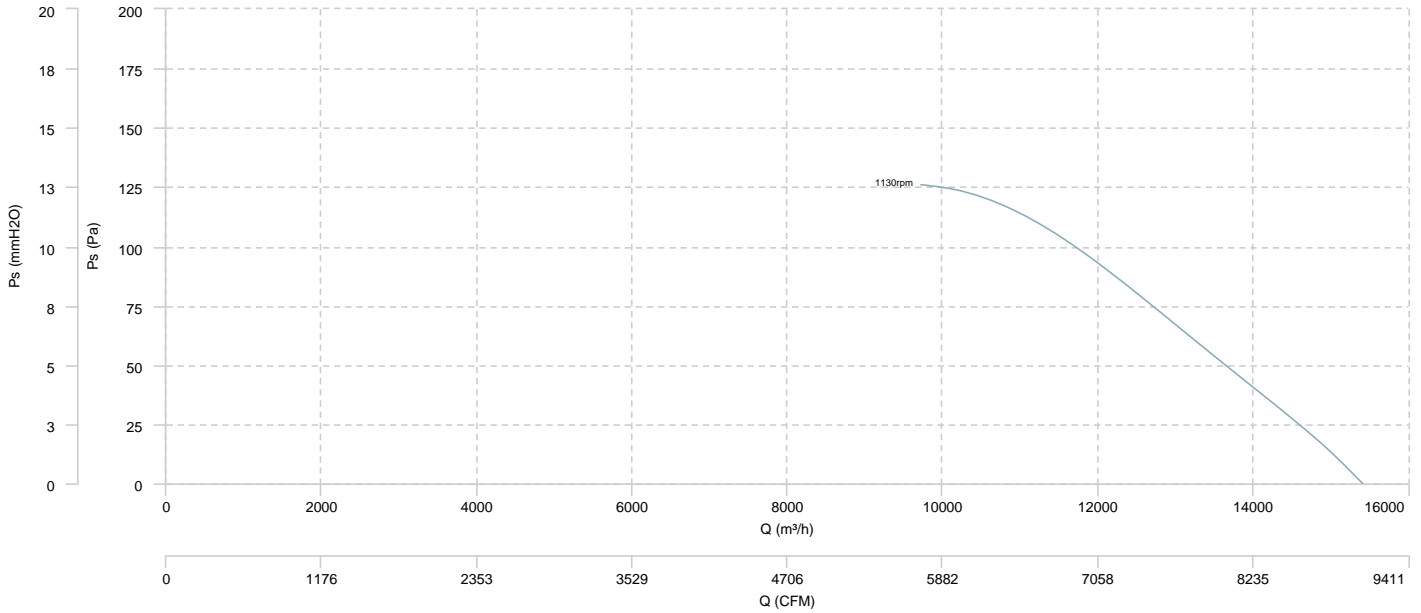

LÉGSZÁLLÍTÁS - MECHANIKAI TELJESÍTMÉNY

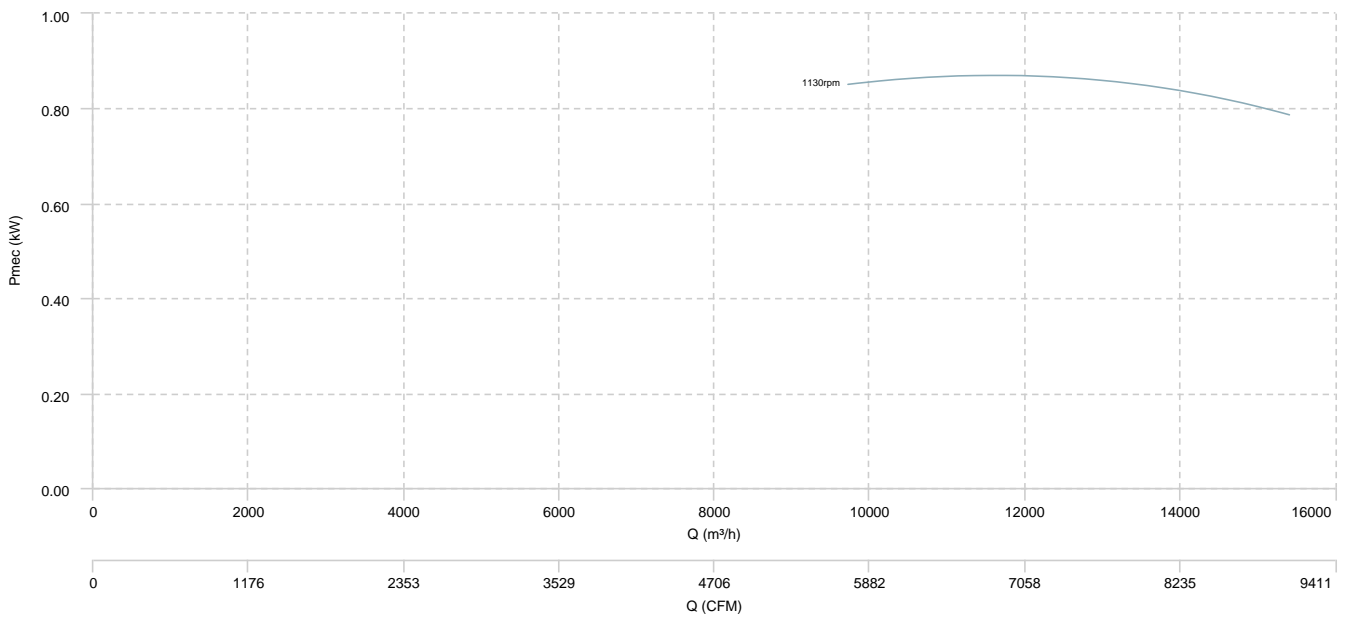

HH-2 63 T4 1,5kW

LÉGSZÁLLÍTÁS - NYOMÁS

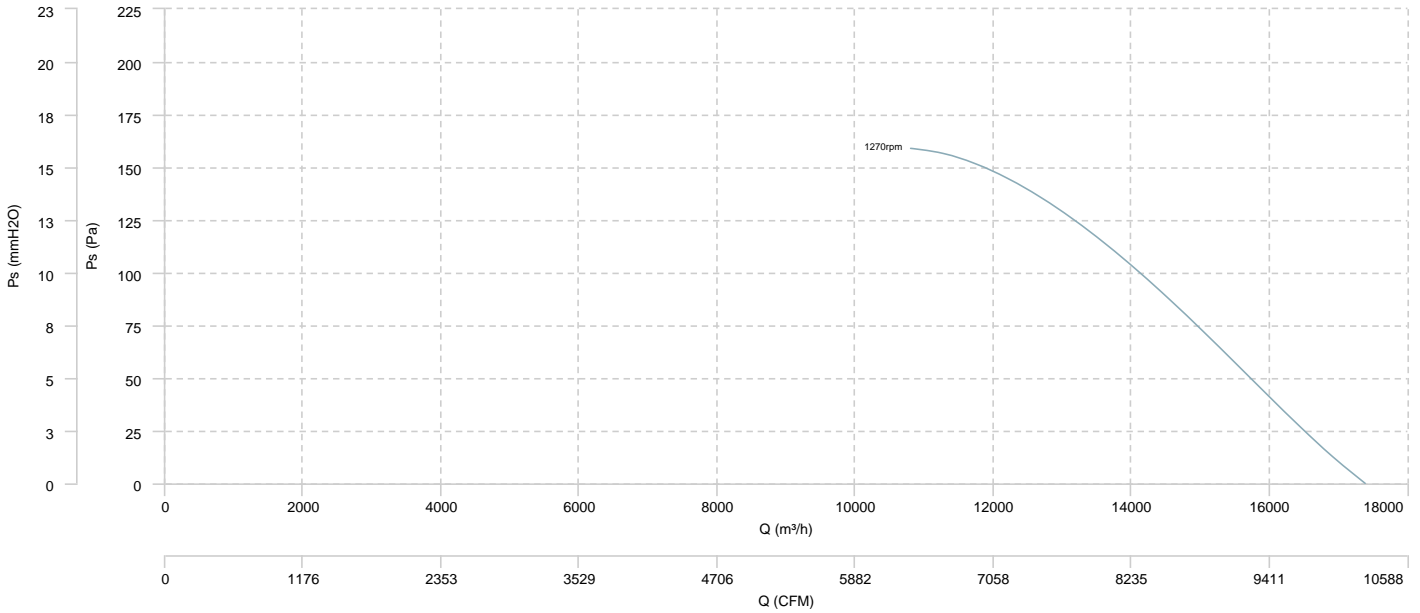

LÉGSZÁLLÍTÁS - MECHANIKAI TELJESÍTMÉNY

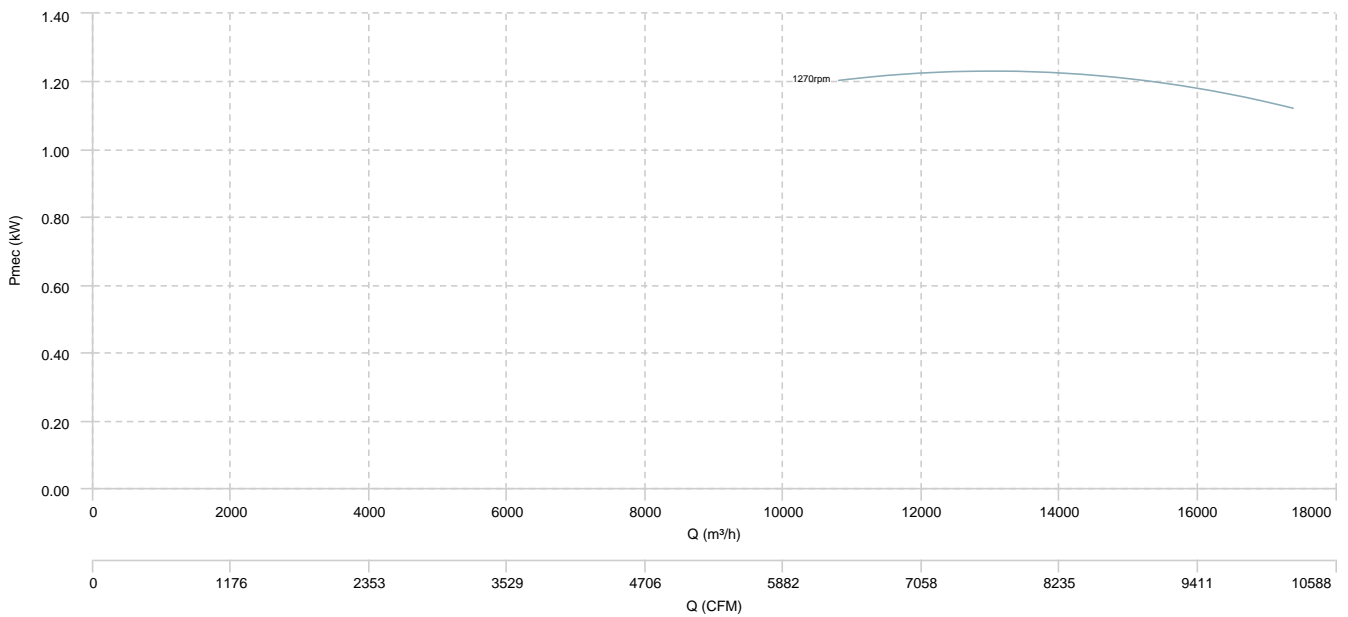

HH-2 71 T4 1,1kW

LÉGSZÁLLÍTÁS - NYOMÁS

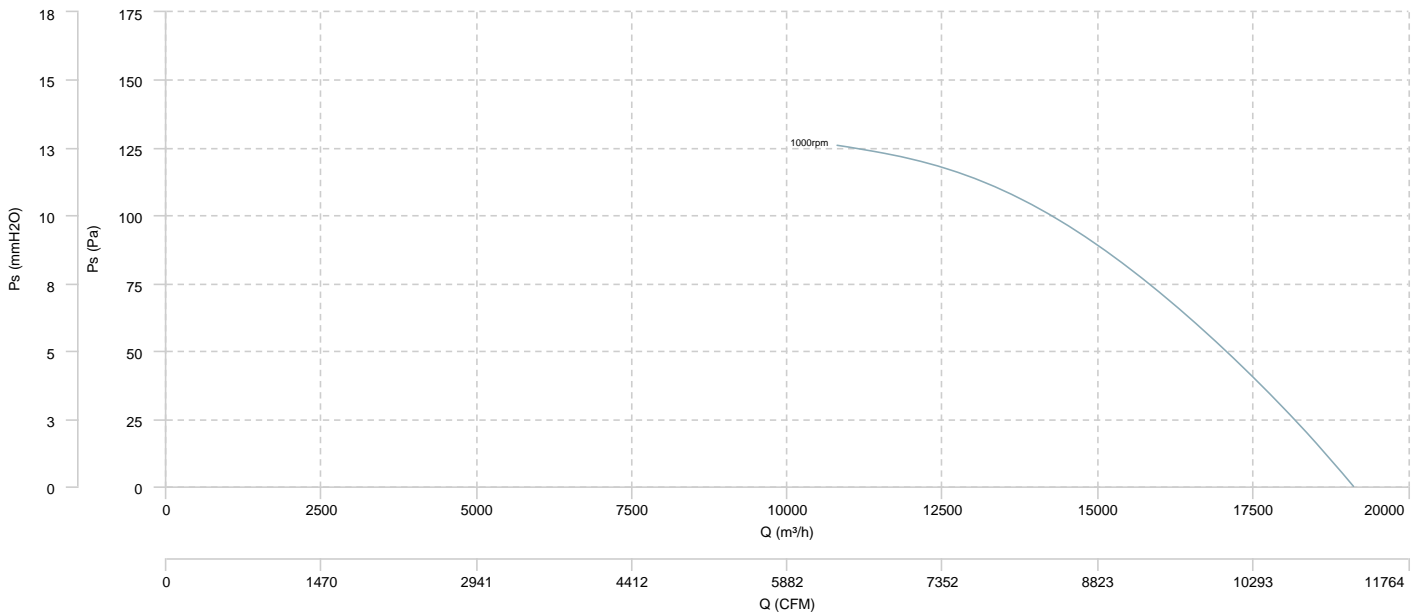

LÉGSZÁLLÍTÁS - MECHANIKAI TELJESÍTMÉNY

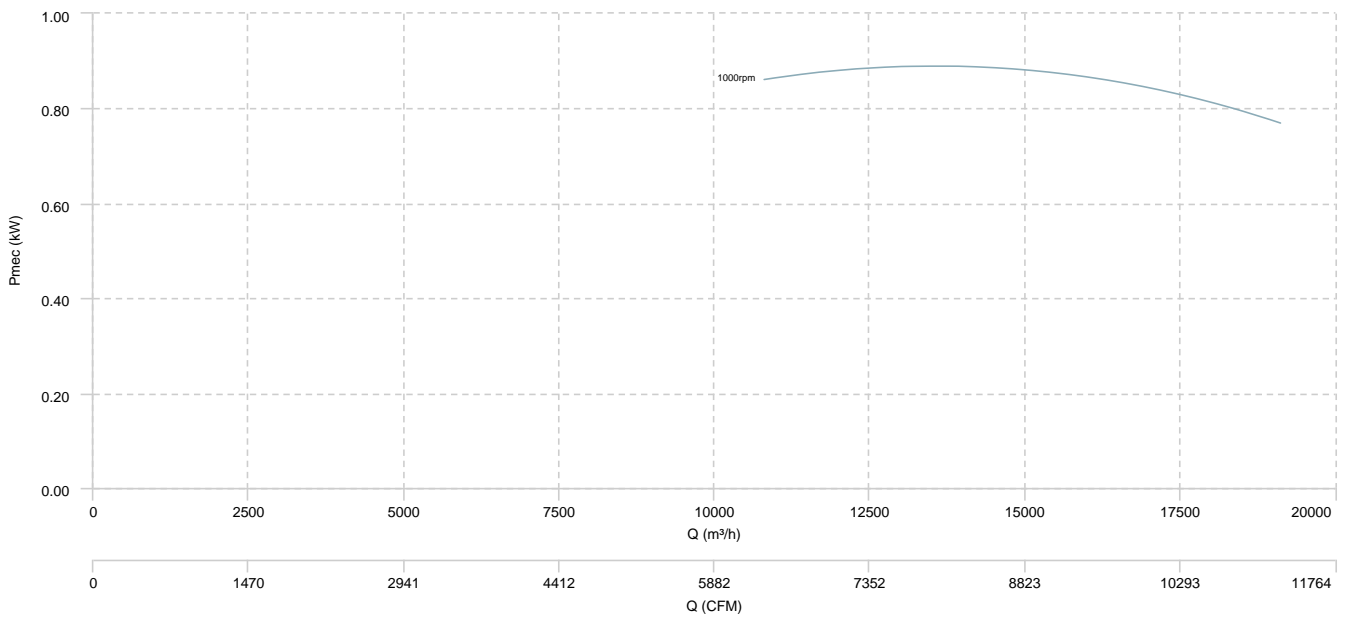

HH-2 71 T4 1,5kW

LÉGSZÁLLÍTÁS - NYOMÁS

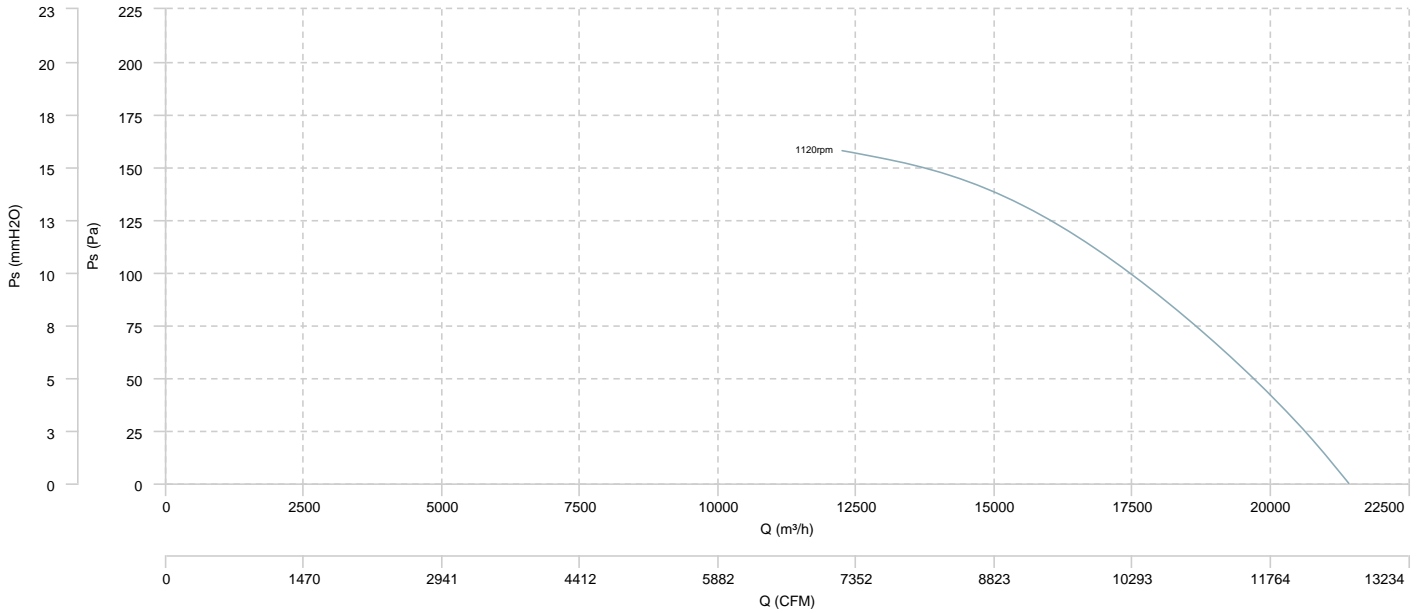

LÉGSZÁLLÍTÁS - MECHANIKAI TELJESÍTMÉNY

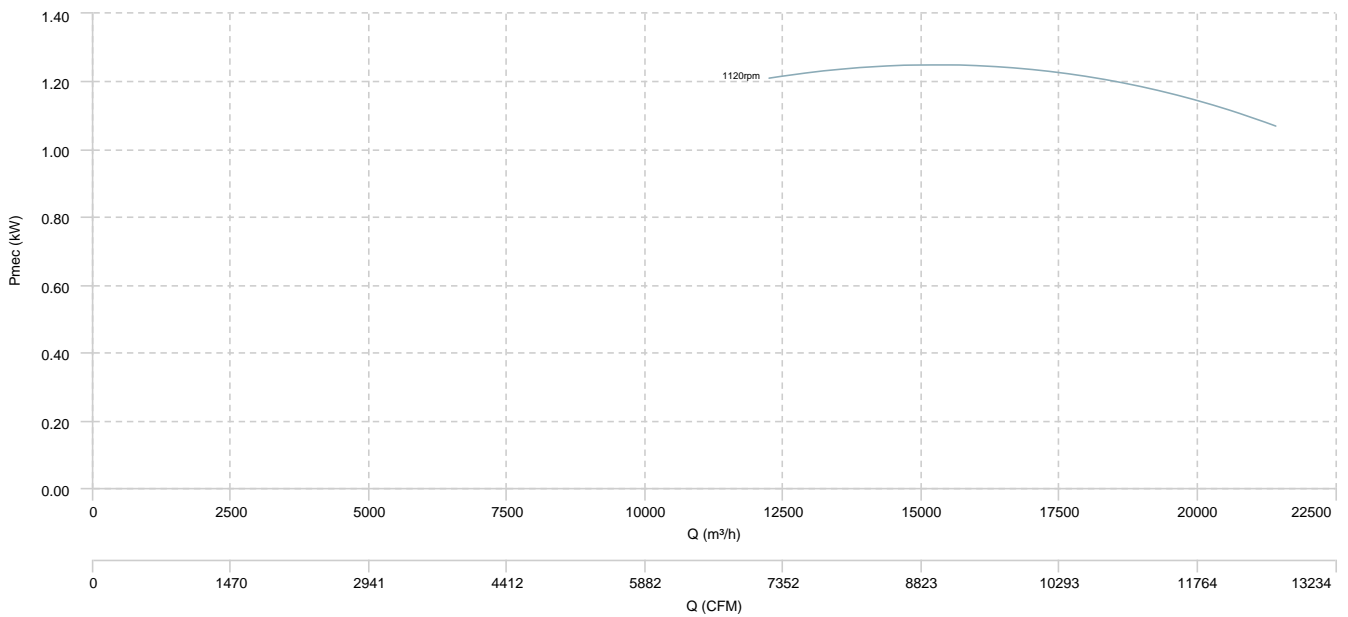

HH-2 71 T4 2,2kW

LÉGSZÁLLÍTÁS - NYOMÁS

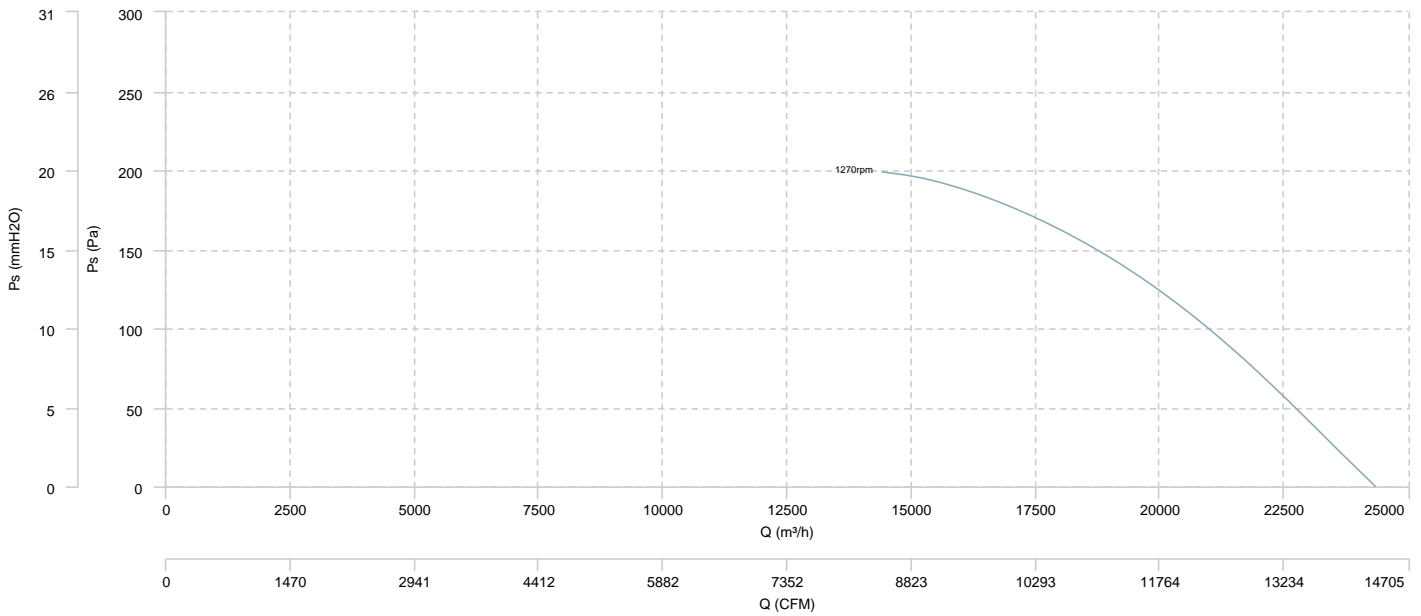

LÉGSZÁLLÍTÁS - MECHANIKAI TELJESÍTMÉNY

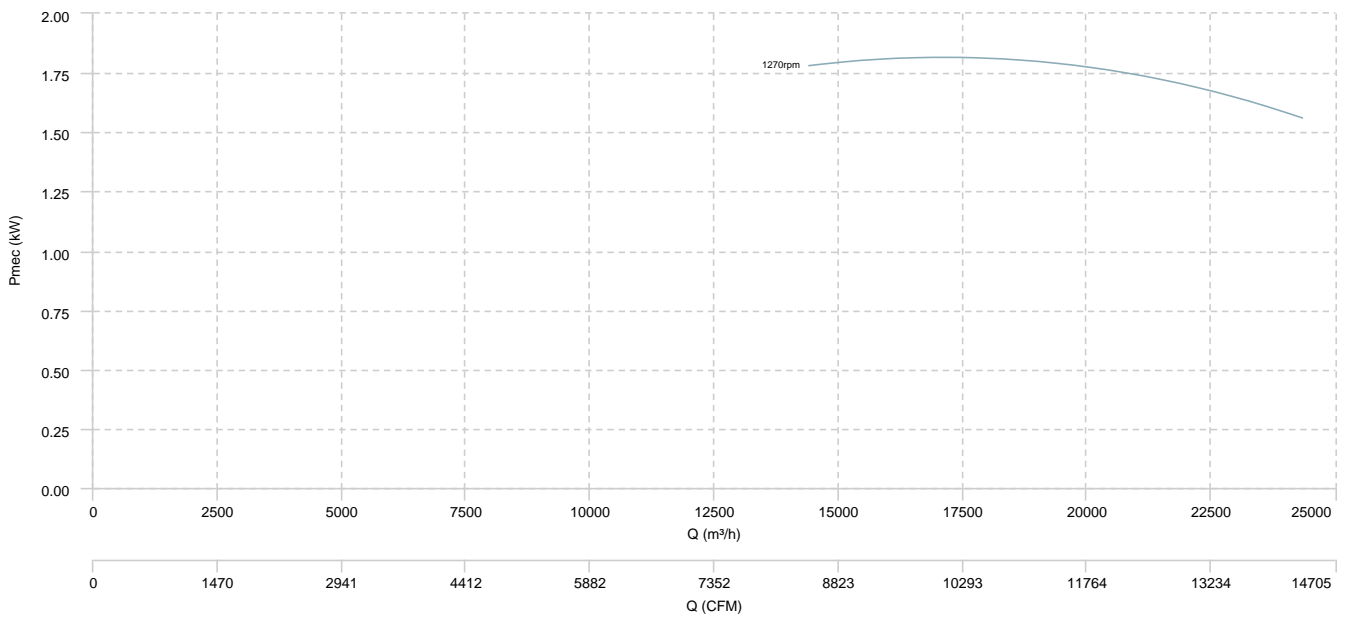

HH-2 80 T4 2,2kW

LÉGSZÁLLÍTÁS - NYOMÁS

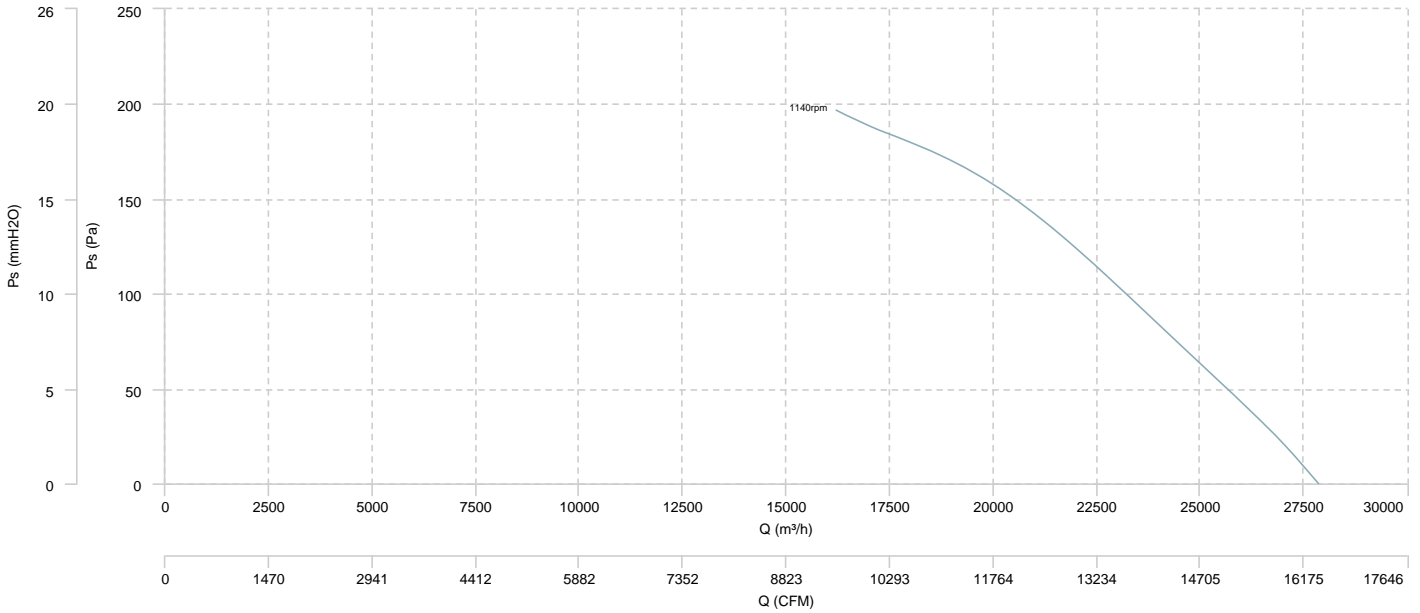

LÉGSZÁLLÍTÁS - MECHANIKAI TELJESÍTMÉNY

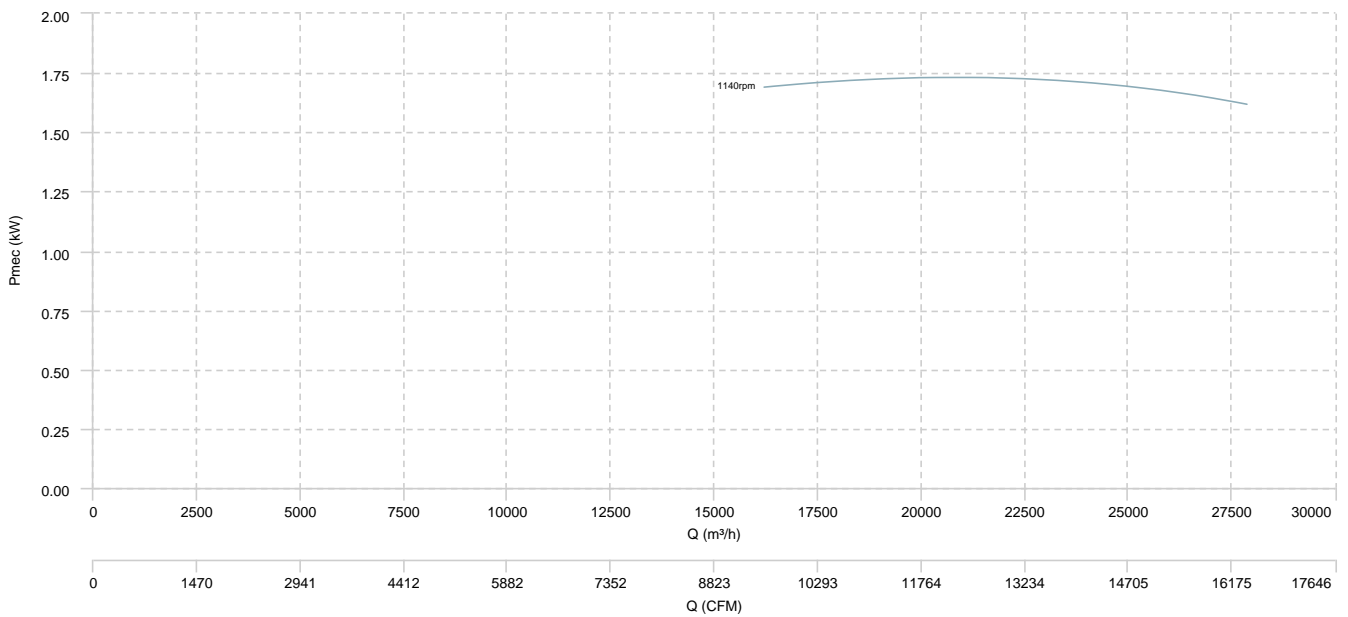

HH-2 80 T4 3kW

LÉGSZÁLLÍTÁS - NYOMÁS

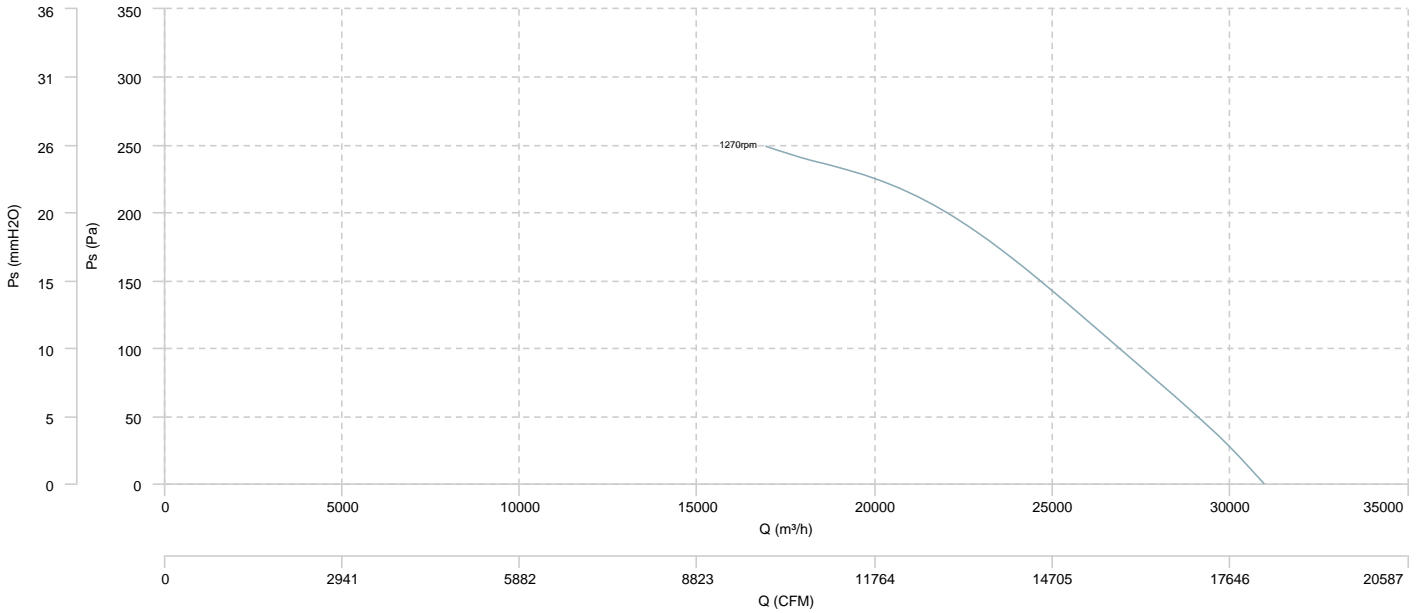

LÉGSZÁLLÍTÁS - MECHANIKAI TELJESÍTMÉNY

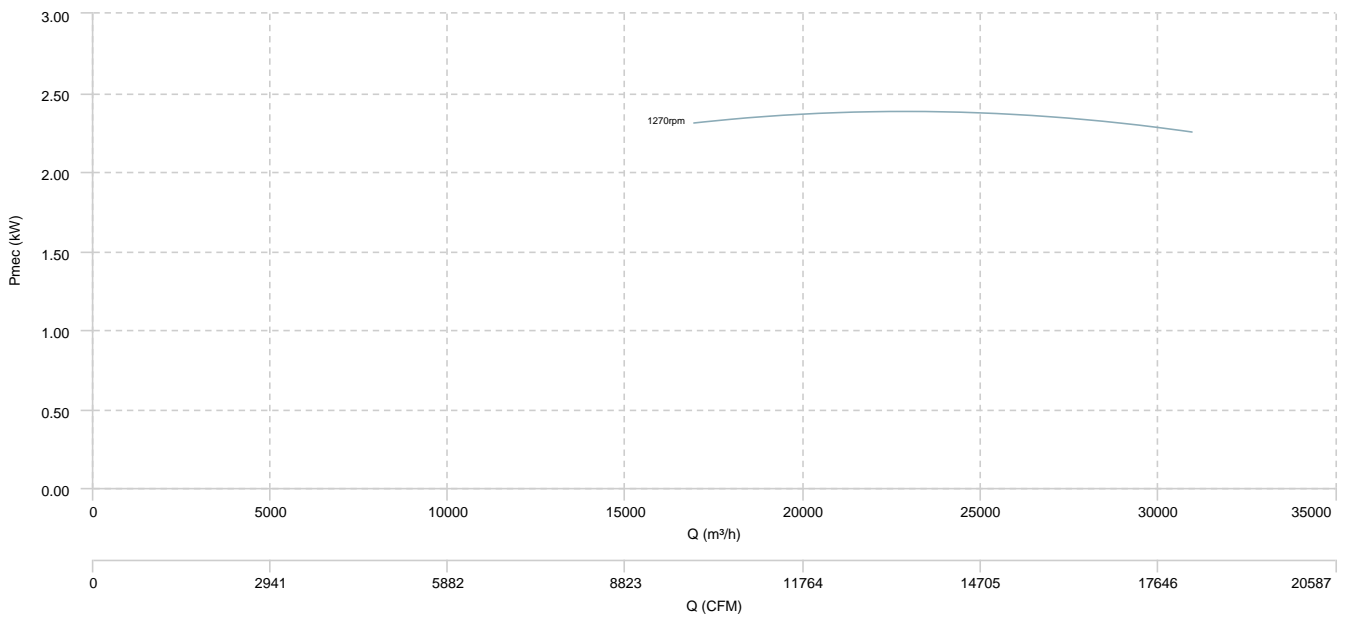

HH-2 80 T4 4kW

LÉGSZÁLLÍTÁS - NYOMÁS

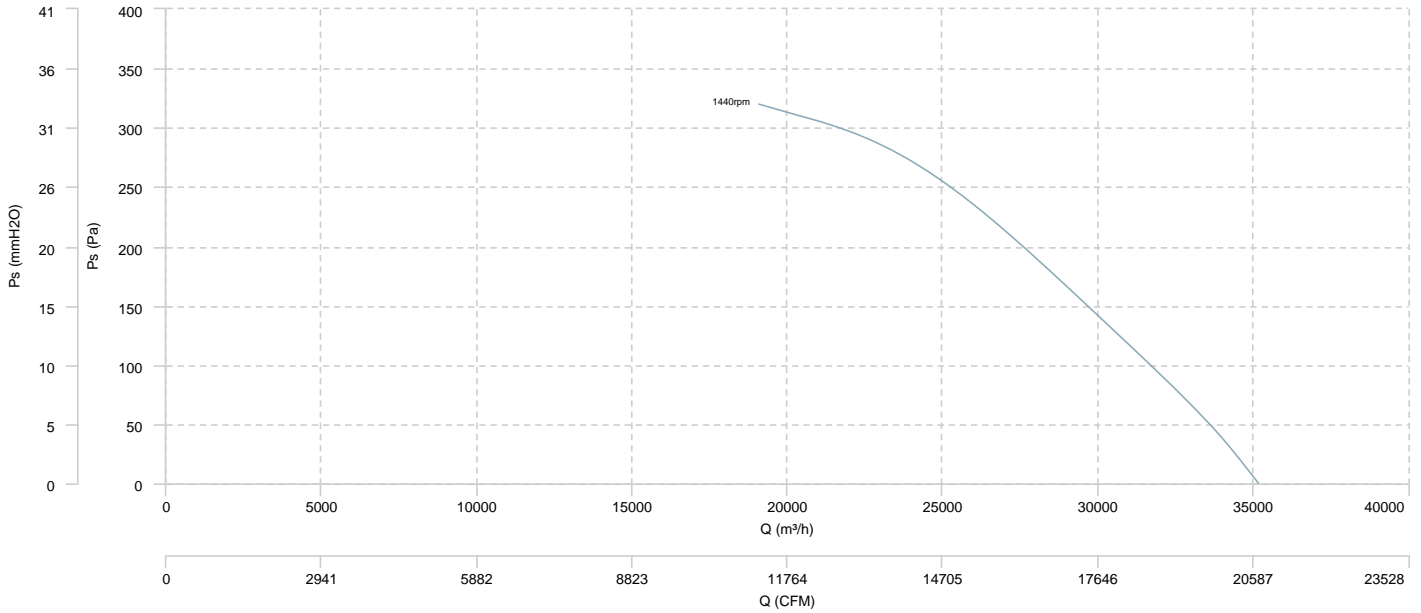

LÉGSZÁLLÍTÁS - MECHANIKAI TELJESÍTMÉNY

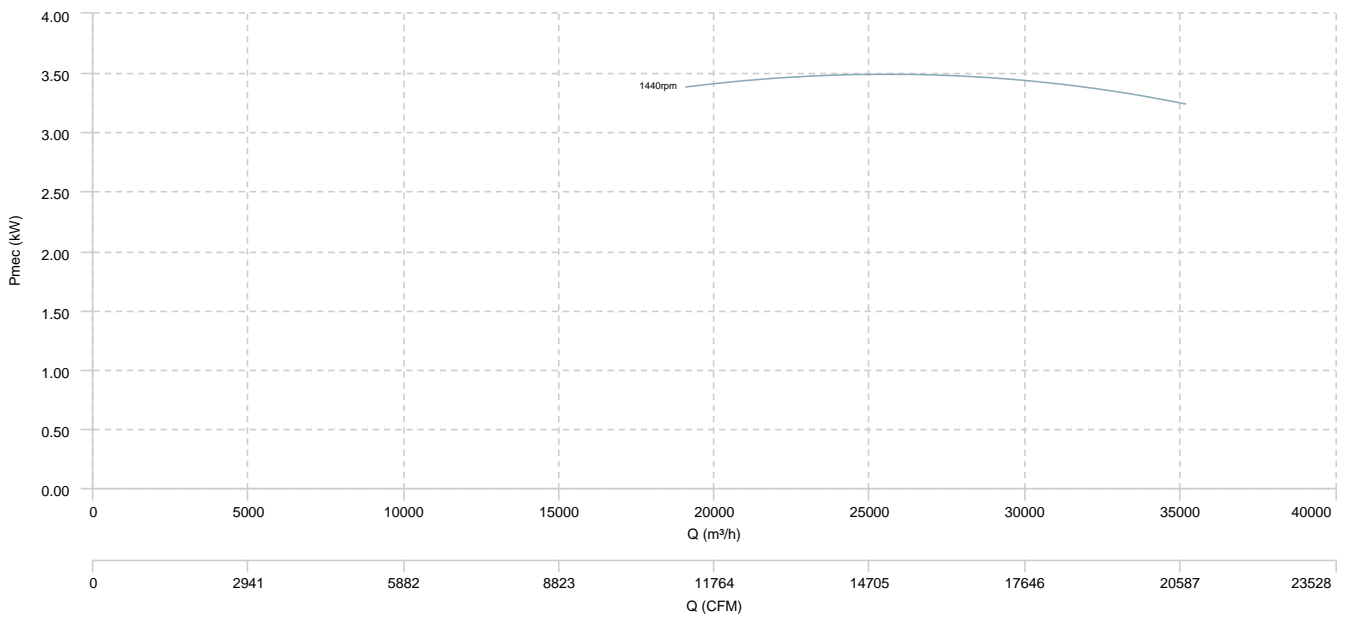

HH-2 90 T4 4kW

LÉGSZÁLLÍTÁS - NYOMÁS

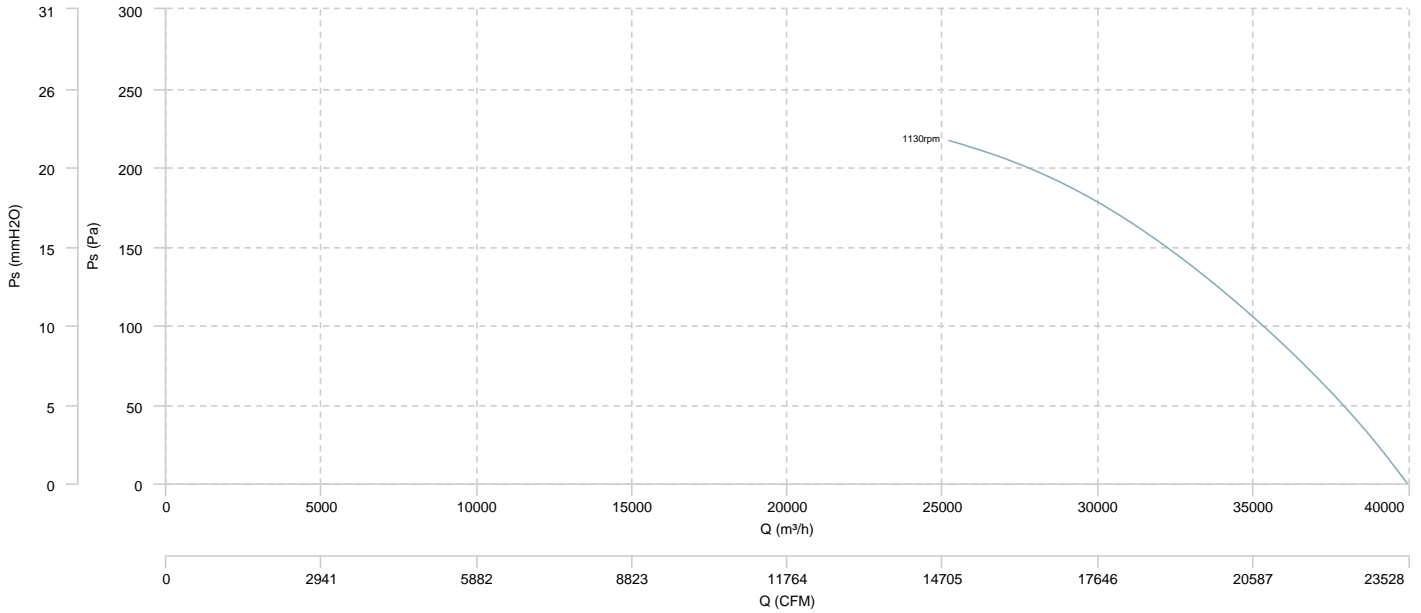

LÉGSZÁLLÍTÁS - MECHANIKAI TELJESÍTMÉNY

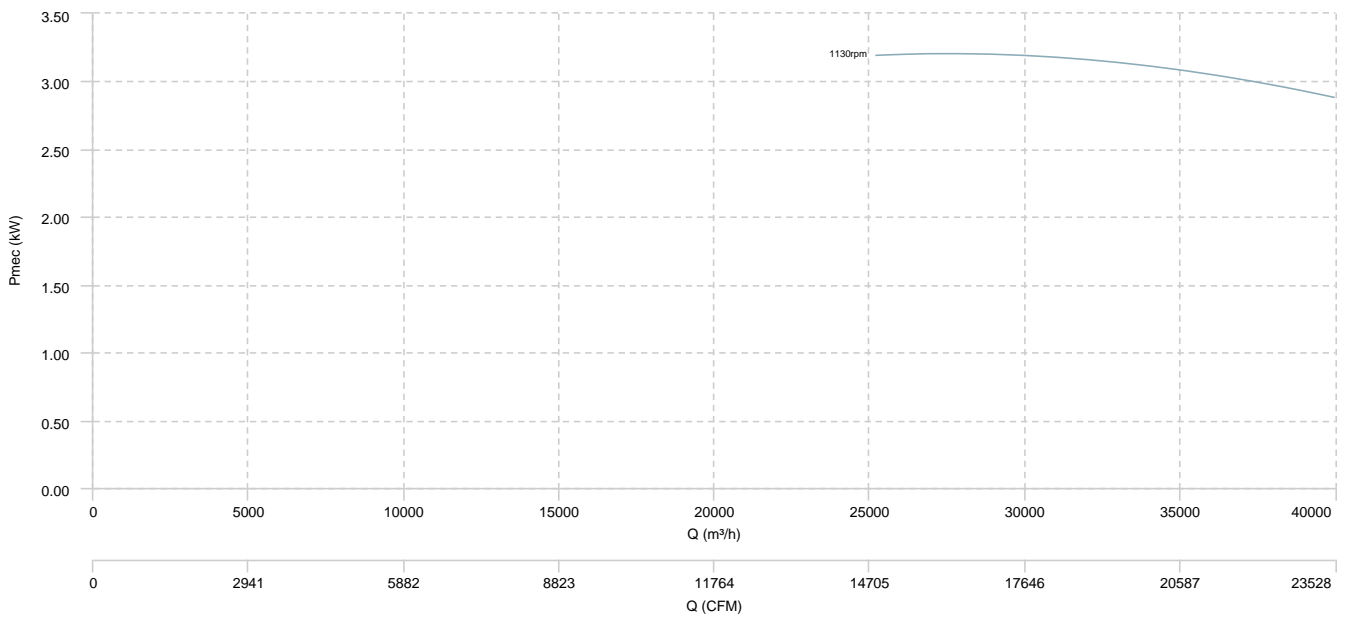

HH-2 90 T4 5,5kW

LÉGSZÁLLÍTÁS - NYOMÁS

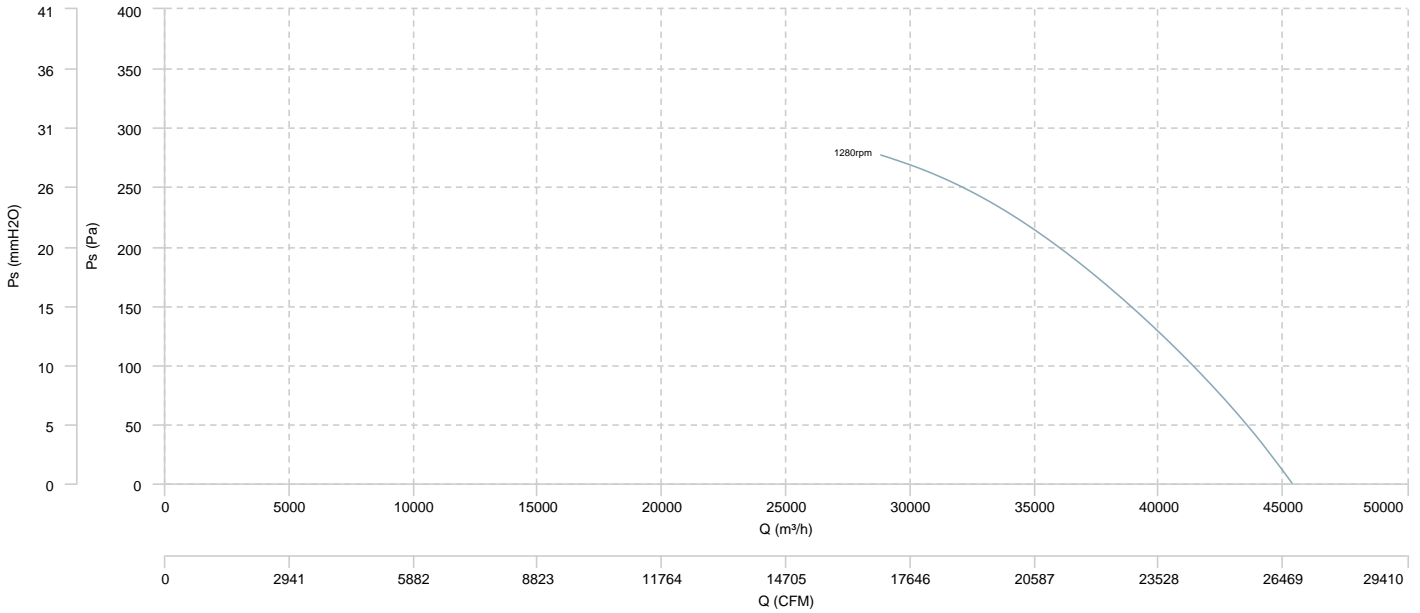

LÉGSZÁLLÍTÁS - MECHANIKAI TELJESÍTMÉNY

